

HCPL-270L/070L/273L/073L

Low Input Current, High Gain, LVTTTL/LVCMOS Compatible Optocouplers



Data Sheet



Description

These high gain series couplers use a Light Emitting Diode and an integrated high gain photodetector to provide extremely high current transfer ratio between input and output. Separate pins for the photodiode and output stage result in LVTTTL compatible saturation voltages and high speed operation. Where desired, the V_{CC} and V_O terminals may be tied together to achieve conventional photo-darlington operation. A base access terminal allows a gain bandwidth adjustment to be made.

These optocouplers are for use in LVTTTL/LVCMOS or other low power applications. A 400% minimum current transfer ratio is guaranteed over 0 to +70°C operating range for only 0.5 mA of LED current.

The HCPL-070L and HCPL-073L are surface mount devices packaged in an industry standard SOIC-8 footprint.

The SOIC-8 does not require "through holes" in a PCB. This package occupies approximately one-third the footprint area of the standard dual-in-line package. The lead profile is designed to be compatible with standard surface mount processes.

Features

- 3.3V/5V Dual Supply Voltages
- Low power consumption
- High current transfer ratio
- Low input current requirements – 0.5 mA
- LVTTTL/LVCMOS compatible output
- Performance guaranteed over temperature 0°C to +70°C
- Base access allows gain bandwidth adjustment
- High output current – 60 mA
- Safety approval, UL, IEC/EN/DIN EN 60747-5-2, CSA

Applications

- Ground isolate most logic families – LVTTTL/LVCMOS
- Low input current line receiver
- High voltage insulation
- EIA RS-232C line receiver
- Telephone ring detector
- V AC line voltage status indicator – low input power dissipation
- Low power systems – ground isolation

Functional Diagram



TRUTH TABLE

LED	V_O
ON	LOW
OFF	HIGH

A 0.1 μ F bypass capacitor connected between pins 8 and 5 is recommended.

CAUTION: It is advised that normal static precautions be taken in handling and assembly of this component to prevent damage and/or degradation which may be induced by ESD.

Ordering Information

HCPL-270L, HCPL-273L, HCPL-070L and HCPL-073L are UL Recognized with 3750 Vrms for 1 minute per UL1577 and are approved under CSA Component Acceptance Notice #5, File CA 88324.

Part Number	Option		Package	Surface Mount	Gull Wing	Tape & Reel	UL 5000 Vrms/ 1 Minute rating	IEC/EN/DIN EN 60747-5-2	Quantity
	RoHS Compliant	non RoHS Compliant							
HCPL-270L	-000E	no option	300 mil DIP-8						50 per tube
	-300E	-300		X	X				50 per tube
HCPL-273L	-500E	-500		X	X	X			1000 per reel
	-060E	-060						X	100 per tube
	-560E	-560		X	X	X		X	1500 per reel
HCPL-070L	-000E	no option	SO-8	X					100 per tube
	-500E	-500		X		X			1500 per reel
HCPL-073L	-060E	-060		X				X	100 per tube
	-560E	-560		X		X		X	1500 per reel

To order, choose a part number from the part number column and combine with the desired option from the option column to form an order entry.

Example 1:

HCPL-273L-500E to order product of 300 mil DIP Gull Wing Surface Mount package in Tape and Reel packaging with IEC/EN/DIN EN 60747-5-2 Safety Approval and RoHS compliant.

Example 2:

HCPL-273L to order product of 300 mil DIP package in Tube packaging and non RoHS compliant.

Option datasheets are available. Contact your Avago sales representative or authorized distributor for information.

Remarks: The notation '#XXX' is used for existing products, while (new) products launched since July 15, 2001 and RoHS compliant will use '-XXxE'.

Selection Guide

8-Pin DIP (300 Mil)		Small Outline S0-8		Minimum Input ON Current (I_F)	Minimum CTR
Single Channel Package HCPL-	Dual Channel Package HCPL-	Single Channel Package HCPL-	Dual Channel Package HCPL-		
270L	273L	070L	073L	0.5 mA	400%

Schematic



HCPL-270L/HCPL-070L



USE OF A 0.1 μ F BYPASS CAPACITOR CONNECTED BETWEEN PINS 5 AND 8 IS RECOMMENDED

HCPL-273L/HCPL-073L

Package Outline Drawings

8-Pin DIP Package

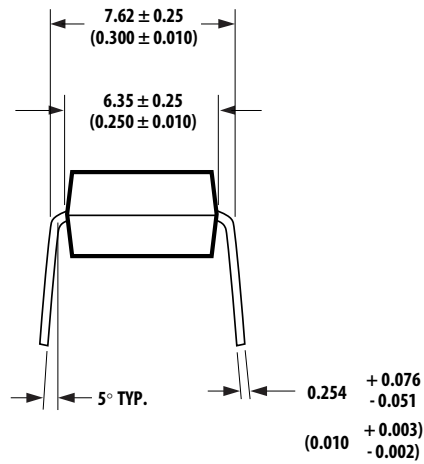
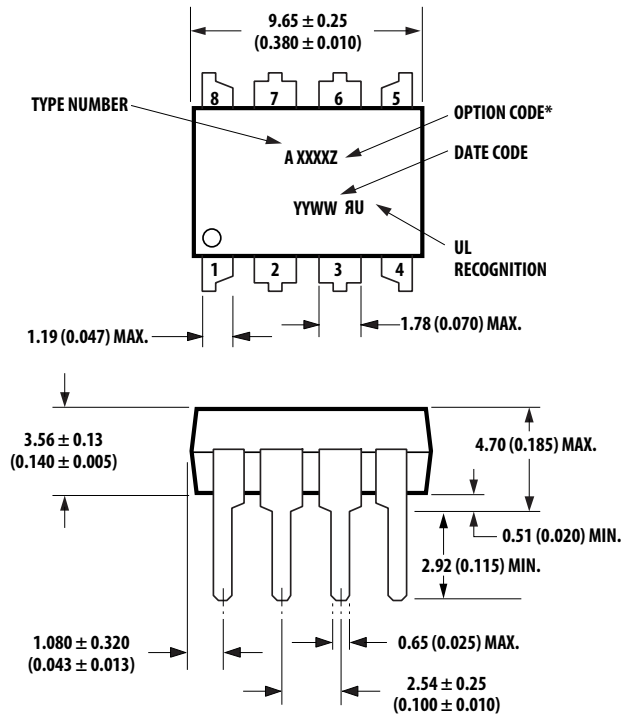

DIMENSIONS IN MILLIMETERS AND (INCHES).
 * MARKING CODE LETTER FOR OPTION NUMBERS
 "L" = OPTION 020
 "V" = OPTION 060
 OPTION NUMBERS 300 AND 500 NOT MARKED.

NOTE: FLOATING LEAD PROTRUSION IS 0.25 mm (10 mils) MAX.

Small Outline SO-8 Package

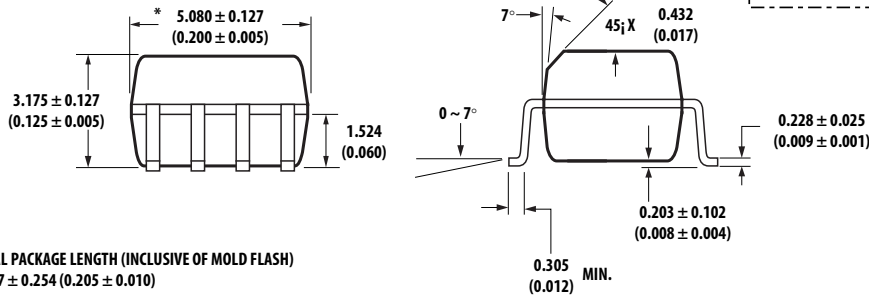
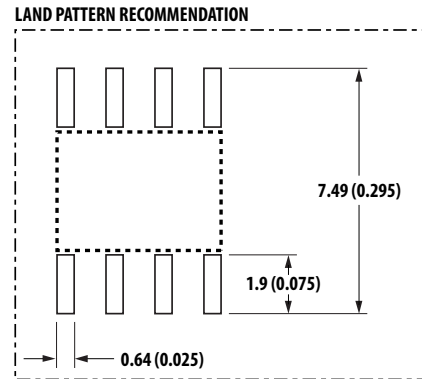
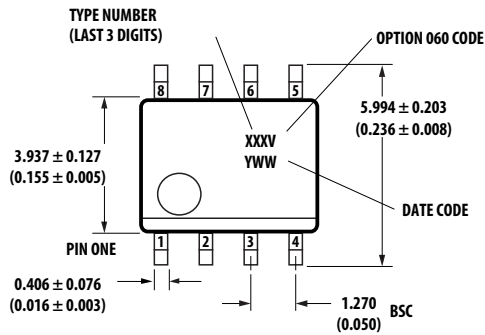

* TOTAL PACKAGE LENGTH (INCLUSIVE OF MOLD FLASH)
 5.207 ± 0.254 (0.205 ± 0.010)

DIMENSIONS IN MILLIMETERS (INCHES).
 LEAD COPLANARITY = 0.10 mm (0.004 INCHES) MAX.
 OPTION NUMBER 500 NOT MARKED.

NOTE: FLOATING LEAD PROTRUSION IS 0.15 mm (6 mils) MAX.

Solder Reflow Temperature Profile

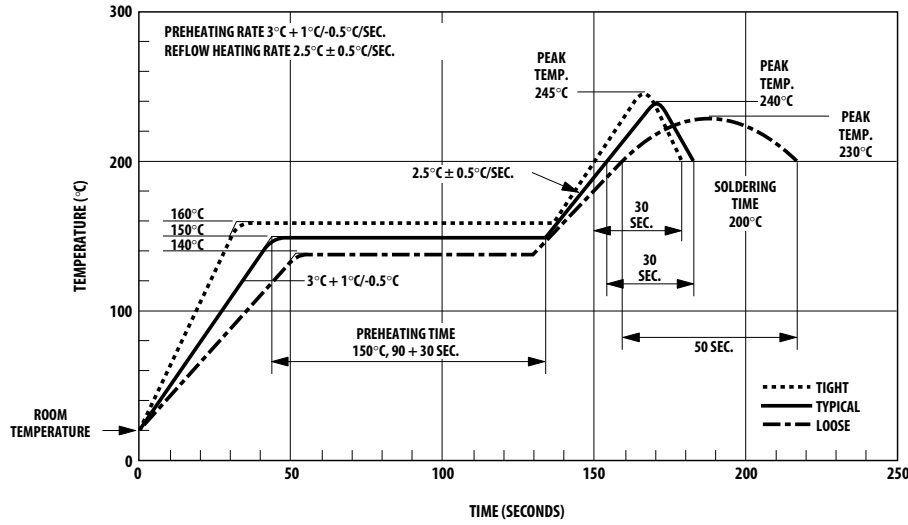

Note: Non-halide flux should be used.

Recommended Pb-Free IR Profile

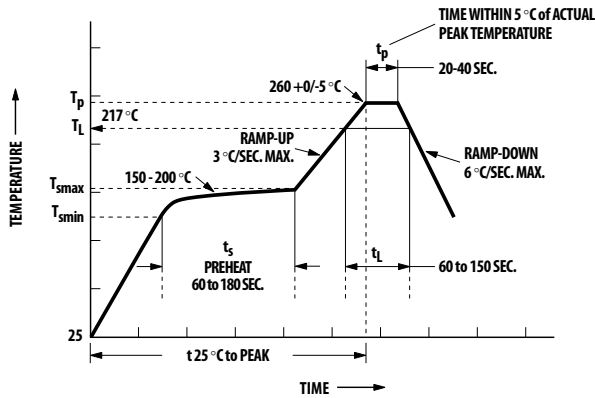

NOTES:

THE TIME FROM 25 °C to PEAK TEMPERATURE = 8 MINUTES MAX.

$T_{smax} = 200^{\circ}\text{C}$, $T_{smin} = 150^{\circ}\text{C}$

Note: Non-halide flux should be used.

Regulatory Information

The devices contained in this data sheet have been approved by the following organizations:

UL Approval under UL 1577, Component Recognition Program, File E55361.

CSA Approval under CSA Component Acceptance Notice #5, File CA 88324.

IEC/EN/DIN EN 60747-5-2

Approved under

IEC 60747-5-2:1997 + A1:2002

EN 60747-5-2:2001 + A1:2002

DIN EN 60747-5-2 (VDE 0884 Teil 2):2003-01 (Option 060 only)

Insulation and Safety Related Specifications

Parameter	Symbol	8-Pin DIP	SO-8	Units	Conditions
		(300 Mil)	Value		
Minimum External Air Gap (External Clearance)	L (101)	7.1	4.9	mm	Measured from input terminals to output terminals, shortest distance through air.
Minimum External Tracking (External Creepage)	L (102)	7.4	4.8	mm	Measured from input terminals to output terminals, shortest distance path along body.
Minimum Internal Plastic Gap (Internal Clearance)		0.08	0.08	mm	Through insulation distance, conductor to conductor, usually the direct distance between the photoemitter and photodetector inside the optocoupler cavity.
Tracking Resistance (Comparative Tracking Index)	CTI	200	200	Volts	DIN IEC 112/VDE 0303 Part 1.
Isolation Group		IIla	IIla		Material Group (DIN VDE 0110, 1/89, Table 1).

IEC/EN/DIN EN 60747-5-2 Insulation Related Characteristics

Description	Symbol	8-pin DIP (300 mil)	SO-8	Units
Installation classification per DIN VDE 0110/1.89, Table 1 for rated mains voltage ≤ 150 V rms for rated mains voltage ≤ 300 V rms for rated mains voltage ≤ 600 V rms			I-IV I-III I-II	
Climatic Classification		55/100/21	55/100/21	
Pollution Degree (DIN VDE 0110/1.89)		2	2	
Maximum Working Insulation Voltage	V_{IORM}	630	566	V_{peak}
Input to Output Test Voltage, Method b* $V_{PR} = 1.875 \times V_{IORM}$, 100% Production Test with $t_p = 1$ sec, Partial Discharge < 5 pC	V_{PR}	1181	1063	V_{peak}
Input to Output Test Voltage, Method a* $V_{PR} = 1.5 \times V_{IORM}$, Type and Sample Test, $t_p = 60$ sec, Partial Discharge < 5 pC	V_{PR}	945	849	V_{peak}
Highest Allowable Overvoltage* (Transient Overvoltage, $t_{ini} = 10$ sec)	V_{IOTM}	6000	4000	V_{peak}
Safety Limiting Values (Maximum values allowed in the event of a failure, also see Figure 11, Thermal Derating curve.)				
Case Temperature	T_S	175	150	$^{\circ}C$
Current (Input Current I_F , $P_S = 0$)	$I_{S,INPUT}$	400	150	mA
Output Power	$P_{S,OUTPUT}$	600	600	mW
Insulation Resistance at T_S , $V_{IO} = 500$ V	R_S	$\geq 10^9$	$\geq 10^9$	Ω

*Refer to the front of the optocoupler section of the current catalog, under Product Safety Regulations section, IEC/EN/DIN EN 60747-5-2, for a detailed description.

Note: Isolation characteristics are guaranteed only within the safety maximum ratings which must be ensured by protective circuits in application.

Absolute Maximum Ratings (No Derating Required up to +85°C)

Parameter	Symbol	Min.	Max.	Units
Storage Temperature	T _S	-55	125	°C
Operating Temperature	T _A	-40	85	°C
Average Forward Input Current	I _{F(AVG)}		20	mA
Peak Forward Input Current (50% Duty Cycle, 1 ms Pulse Width)	I _{F(PEAK)}		40	mA
Peak Transient Input Current (< 1 μs Pulse Width, 300 pps)	I _{F(TRAN)}		1.0	A
Reverse Input Voltage	V _R		5	V
Input Power Dissipation	P _I		35	mW
Output Current (Pin 6)	I _O		60	mA
Emitter Base Reverse Voltage (Pin 5-7)	V _{EB}		0.5	V
Supply Voltage and Output Voltage	V _{CC}	-0.5	7	V
Output Power Dissipation	P _O		100	mW
Total Power Dissipation	P _T		135	mW
Lead Solder Temperature (for Through Hole Devices)		260°C for 10 sec., 1.6 mm below seating plane.		
Reflow Temperature Profile (for SOIC-8 and Option #300)		See Package Outline Drawings section.		

Recommended Operating Conditions

Parameter	Symbol	Min.	Max.	Units
Power Supply Voltage	V _{CC}	2.7	7.0	V
Forward Input Current (ON)	I _{F(ON)}	0.5	12.0	mA
Forward Input Voltage (OFF)	V _{F(OFF)}	0	0.8	V
Operating Temperature	T _A	0	70	°C

Electrical Specifications

$0^{\circ}\text{C} \leq T_A \leq +70^{\circ}\text{C}$, $2.7\text{ V} \leq V_{CC} \leq 3.3\text{ V}$, $0.5\text{ mA} \leq I_{F(\text{ON})} \leq 12\text{ mA}$, $0\text{ V} \leq V_{F(\text{OFF})} \leq 0.8\text{ V}$, unless otherwise specified.
All typicals at $T_A = 25^{\circ}\text{C}$. (See Note 8.)

Parameter	Sym.	Device	Min.	Typ.*	Max.	Units	Test Conditions	Fig.	Note
Current Transfer Ratio	CTR	HCPL-	400	1300	5000	%	$I_F = 0.5\text{ mA}$ $V_{CC} = 3.3\text{ V}$ $V_O = 0.4\text{ V}$	1, 2	2
Logic Low Output Voltage	V_{OL}			0.05	0.3	V	$I_F = 1.6\text{ mA}$, $I_O = 8\text{ mA}$	$V_{CC} = 3.3\text{ V}$	
				0.05	0.4	V	$I_F = 5.0\text{ mA}$, $I_O = 15\text{ mA}$		
Logic High Output Current	I_{OH}		5	25	μA	$V_O = V_{CC} = 3.3\text{ V}$	$I_F = 0\text{ mA}$		2
Logic Low Supply Current	I_{CCL}	270L/070L	0.4	1.3	mA	$V_{CC} = 3.3\text{ V}$	$I_{F1} = I_{F2} = 1.6\text{ mA}$ $V_{O1} = V_{O2} = \text{Open}$		
		273L/073L	0.8	2.7	mA				
Logic High Supply Current	I_{CCH}	270L/070L	0.002	1	μA	$V_{CC} = 3.3\text{ V}$	$I_{F1} = I_{F2} = 0\text{ mA}$ $V_{O1} = V_{O2} = \text{Open}$		
		273L/073L	0.002	2	μA				
Input Forward Voltage	V_F		1.5	1.7	V	$T_A = 25^{\circ}\text{C}$	$I_F = 1.6\text{ mA}$	3, 4	
Input Reverse Breakdown Voltage	BV_R		5.0		V	$I_R = 10\ \mu\text{A}$, $T_A = 25^{\circ}\text{C}$			2
Temperature Coefficient of Forward Voltage	$\Delta V_F / \Delta T_A$			-1.8		$\text{mV}/^{\circ}\text{C}$	$I_F = 1.6\text{ mA}$		
Input Capacitance	C_{IN}		60			pF	$f = 1\text{ MHz}$, $V_F = 0$		2

*All typical values at $T_A = 25^{\circ}\text{C}$ and $V_{CC} = 3.3\text{ V}$, unless otherwise noted.

Electrical Specifications

$0^{\circ}\text{C} \leq T_A \leq 70^{\circ}\text{C}$, $4.5\text{ V} \leq V_{CC} \leq 7\text{ V}$, $0.5\text{ mA} \leq I_{F(\text{ON})} \leq 12\text{ mA}$, $0\text{ V} \leq V_{F(\text{OFF})} \leq 0.8\text{ V}$, unless otherwise specified.
All Typicals at $T_A = 25^{\circ}\text{C}$. (See note 8.)

Parameter	Sym.	Device	Min.	Typ.*	Max.	Units	Test Conditions	Fig.	Note
Current Transfer Ratio	CTR		300	1600	2600	%	$I_F = 1.6\text{ mA}$, $V_{CC} = 4.5\text{ V}$, $V_O = 0.5\text{ V}$	2, 3	2
Logic Low Output Voltage	V_{OL}			0.1	0.4	V	$I_F = 1.6\text{ mA}$, $I_O = 4.8\text{ mA}$, $V_{CC} = 4.5\text{ V}$	1	
Logic High Output Current	I_{OH}			0.1	250	μA	$V_O = V_{CC} = 7\text{ V}$, $I_F = 0\text{ mA}$		2
Logic Low Supply Current	I_{CCL}			0.9	3	mA	$V_{CC} = 7\text{ V}$, $I_{F1} = I_{F2} = 1.6\text{ mA}$ $V_{O1} = V_{O2} = \text{Open}$		5
Logic High Supply Current	I_{CCH}			0.004	20	μA	$V_{CC} = 7\text{ V}$, $I_{F1} = I_{F2} = 0\text{ mA}$, $V_{O1} = V_{O2} = \text{Open}$		5
Input Forward Voltage	V_F			1.4	1.7	V	$T_A = 25^{\circ}\text{C}$		4
					1.75	V			
Input Reverse Breakdown Voltage	BV_R		5		V	$I_R = 10\ \mu\text{A}$, $T_A = 25^{\circ}\text{C}$			2
Temperature Coefficient of Forward Voltage	$\Delta V_F / \Delta T_A$			-1.8		$\text{mV}/^{\circ}\text{C}$	$I_F = 1.6\text{ mA}$		
Input Capacitance	C_{IN}		60			pF	$f = 1\text{ MHz}$, $V_F = 0$		2

*All typical values at $T_A = 25^{\circ}\text{C}$ and $V_{CC} = 5\text{ V}$, unless otherwise noted.

Switching Specifications (AC)

Over Recommended Operating Conditions ($T_A = 0^\circ\text{C}$ to $+70^\circ\text{C}$), $V_{CC} = 3.3\text{ V}$, unless otherwise specified. (See Note 8.)

Parameter	Sym.	Min.	Typ.*	Max.	Units	Test Conditions	Fig.	Note
Propagation Delay Time to Logic Low at Output	t_{PHL}			30	μs	$I_F = 0.5\text{ mA}$, $R_I = 4.7\text{ k}\Omega$	5	2
Propagation Delay Time to Logic High at Output	t_{PLH}			90	μs	$I_F = 0.5\text{ mA}$, $R_L = 4.7\text{ k}\Omega$	5	2
Common Mode Transient Immunity at Logic High Level Output	$ CM_H $	1000	10000		$\text{V}/\mu\text{s}$	$I_F = 0\text{ mA}$, $T_A = 25^\circ\text{C}$, $R_I = 2.2\text{ k}\Omega$ $ V_{CM} = 10\text{ V}_{p-p}$	6	2, 6, 7
Common Mode Transient Immunity at Logic Low Level Output	$ CM_L $	1000	10000		$\text{V}/\mu\text{s}$	$I_F = 1.6\text{ mA}$, $T_A = 25^\circ\text{C}$, $R_I = 2.2\text{ k}\Omega$ $ V_{CM} = 10\text{ V}_{p-p}$	6	2, 6, 7

*All typical values at $T_A = 25^\circ\text{C}$ and $V_{CC} = 3.3\text{ V}$, unless otherwise noted.

Switching Specifications (AC)

Over recommended operating conditions ($T_A = 0^\circ\text{C}$ to 70°C), $V_{CC} = 5\text{ V}$, unless otherwise specified. (See note 8.)

Parameter	Sym.	Min.	Typ.*	Max.	Units	Test Conditions	Fig.	Note
Propagation Delay Time to LogicLow at Output	t_{PHL}			25		$I_F = 1.6\text{ mA}$, $R_L = 2.2\text{ k}\Omega$	6, 7, 8, 9	2
Propagation Delay Time to Logic High at Output	t_{PLH}			50		$I_F = 1.6\text{ mA}$, $R_L = 2.2\text{ k}\Omega$	7, 8, 9	2
Common Mode Transient Immunity at Logic High Output	$ CM_H $	1000	10000		$\text{V}/\mu\text{s}$	$I_F = 0\text{ mA}$, $T_A = 25^\circ\text{C}$, $R_L = 2.2\text{ k}\Omega$ $ V_{CM} = 10\text{ V}_{p-p}$	10	2, 6, 7
Common Mode Transient Immunity at Logic Low Output	$ CM_H $	1000	10000		$\text{V}/\mu\text{s}$	$I_F = 1.6\text{ mA}$, $T_A = 25^\circ\text{C}$, $R_L = 2.2\text{ k}\Omega$ $ V_{CM} = 10\text{ V}_{p-p}$	10	2, 6, 7

*All typical values at $T_A = 25^\circ\text{C}$ and $V_{CC} = 5\text{ V}$, unless otherwise noted.

Package Characteristics

Parameter	Sym.	Device HCPL-	Min.	Typ.*	Max.	Units	Test Conditions	Fig.	Note
Input-Output Momentary Withstand Voltage**	V_{ISO}		3750			V rms	RH \leq 50%, t = 1 min., $T_A = 25^\circ\text{C}$		4, 9
Resistance (Input-Output)	R_{I-O}			10^{12}		Ω	$V_{I-O} = 500\text{ Vdc}$ RH \leq 45%		4
Capacitance (Input-Output)	C_{I-O}			0.6		pF	f = 1 MHz		11
Input-Input Insulation Leakage Current	I_{I-I}		0.005			μA	RH \leq 45% $V_{I-I} = 500\text{ Vdc}$		5
Input-Input Insulation Leakage Current	R_{I-I}			10^{11}		Ω			5
Capacitance (Input-Input)	C_{I-I}	270L 273L 070L 073L		0.03 0.25		pF			5

*All typical values at $T_A = 25^\circ\text{C}$, unless otherwise noted.

**The Input-Output Momentary Withstand Voltage is a dielectric voltage rating that should not be interpreted as an input-output continuous voltage rating. For the continuous voltage rating refer to the IEC/EN/DIN EN 60747-5-2 Insulation Characteristics Table (if applicable), your equipment level safety specification or Avago Application Note 1074 entitled "Optocoupler Input-Output Endurance Voltage."

Notes:

- Pin 5 should be the most negative voltage at the detector side.
- Each channel.
- DC CURRENT TRANSFER RATIO (CTR) is defined as the ratio of output collector current, I_O , to the forward LED input current, I_F , times 100%.
- Device considered a two-terminal device: pins 1, 2, 3, and 4 shorted together, and pins 5, 6, 7, and 8 shorted together.
- Measured between pins 1 and 2 shorted together, and pins 3 and 4 shorted together.
- Common mode transient immunity in a Logic High level is the maximum tolerable (positive) dV_{CM}/dt of the common mode pulse, V_{CM} , to assure that the output will remain in a Logic High state (i.e., $V_O > 2.0\text{ V}$). Common mode transient immunity in a Logic Low level is the maximum tolerable (negative) dV_{CM}/dt of the common mode pulse, V_{CM} , to assure that the output will remain in a Logic Low state (i.e., $V_O < 0.8\text{ V}$).
- In applications where dV/dt may exceed $50,000\text{ V}/\mu\text{s}$ (such as static discharge) a series resistor, R_{CC} , should be included to protect the detector IC from destructively high surge currents. The recommended value is $R_{CC} = 110\ \Omega$.
- Use of a $0.1\ \mu\text{F}$ bypass capacitor connected between pins 5 and 8 adjacent to the device is recommended.
- In accordance with UL 1577, each optocoupler is proof tested by applying an insulation test voltage $> 4500\text{ V rms}$ for 1 second (leakage detection current limit, $I_{I-O} < 5\ \mu\text{A}$).
- In accordance with UL 1577, each optocoupler is proof tested by applying an insulation test voltage $> 6000\text{ V rms}$ for 1 second (leakage detection current limit, $I_{I-O} < 5\ \mu\text{A}$).
- Measured between the LED anode and cathode shorted together and pins 5 through 8 shorted together.
- Derate linearly above 65°C free-air temperature at a rate of $2.3\text{ mW}/^\circ\text{C}$ for the SO-8 package.



Figure 1. Current transfer ratio vs. forward current



Figure 2. Current transfer ratio vs. forward current

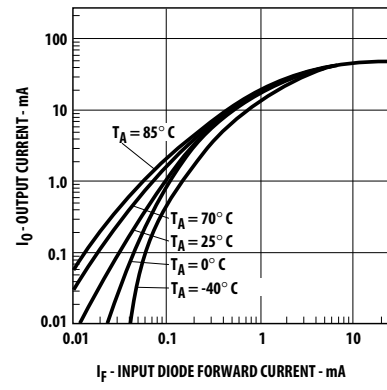

Figure 3. Output current vs. input diode forward current



Figure 4. Output current vs. input diode forward current



Figure 5. Input diode forward current vs. forward voltage



Figure 6. Forward voltage vs. temperature

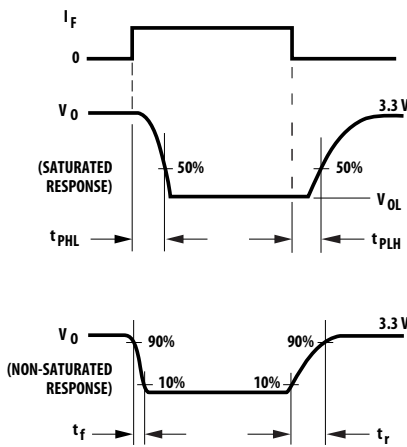

Figure 7. Switching test circuit



* INCLUDES PROBE AND FIXTURE CAPACITANCE



Figure 8. Switching test circuit



Figure 9. Test circuit for transient immunity and typical waveforms



Figure 10. Test circuit for transient immunity and typical waveforms

For product information and a complete list of distributors, please go to our website: www.avagotech.com

Avago, Avago Technologies, and the A logo are trademarks of Avago Technologies Limited in the United States and other countries. Data subject to change. Copyright © 2005-2008 Avago Technologies Limited. All rights reserved. Obsoletes AV01-0544EN AV02-1054EN - April 3, 2008

AVAGO
TECHNOLOGIES