

SIEMENS

SIEMENS AKTIENGESELLSCHAFT

T-43-25

Transistor Array with 5 NPN Transistors**TCA 671****TCA 871****TCA 971****TCA 991****Bipolar IC****Features**

- Versatile use
- Slight V_{BE} and B deviations
- High output current
- Good thermal matching
- TCA 971; G/TCA 991; G compatible with 3045/46/86 and 3146

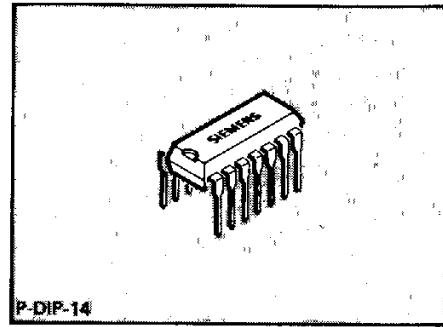
**4**

Type	Ordering Code	Package
STCA 671	Q67000-T1	P-DIP-14
STCA 671 G	Q67000-A2366	P-DSO-14 (SMD)
STCA 871	Q67000-T2	P-DIP-14
STCA 871 G	Q67000-A2367	P-DSO-14 (SMD)
STCA 971	Q67000-T11	P-DIP-14
STCA 971 G	Q67000-A8075	P-DSO-14 (SMD)
STCA 991	Q67000-T12	P-DIP-14
STCA 991 G	Q67000-A8076	P-DSO-14 (SMD)

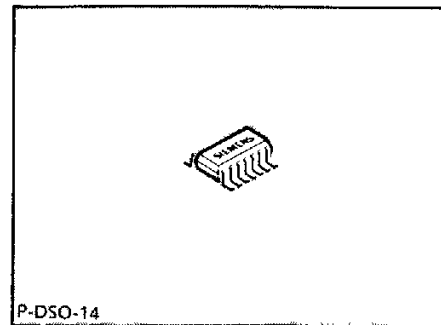

TCA 671, TCA 871, TCA 971, and TCA 991 are monolithic integrated transistor arrays each consisting of five NPN transistors. The arrays are well suited for switching and amplifying applications up to approx. 30 MHz. Due to a uniform design, the transistor characteristics show only slight deviations. The arrays are preferably intended for lamp drivers, amplifiers, pulse generators, and types TCA 971 and TCA 991 especially for discrete differential amplifiers.

Pin Configurations
(top view)

TCA 671, TCA 871
TCA 971, TCA 991

substrate = pin 3
substrate = pin 13

TCA 671 G, TCA 871 G,
TCA 971 G, TCA 991 G

Substrate connection has to be on the most negative potential.

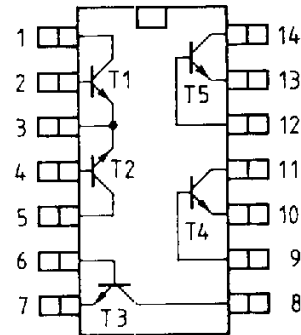
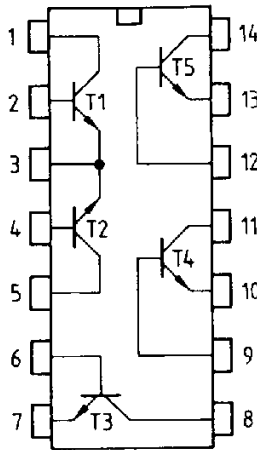

Test Circuit for Switching Times

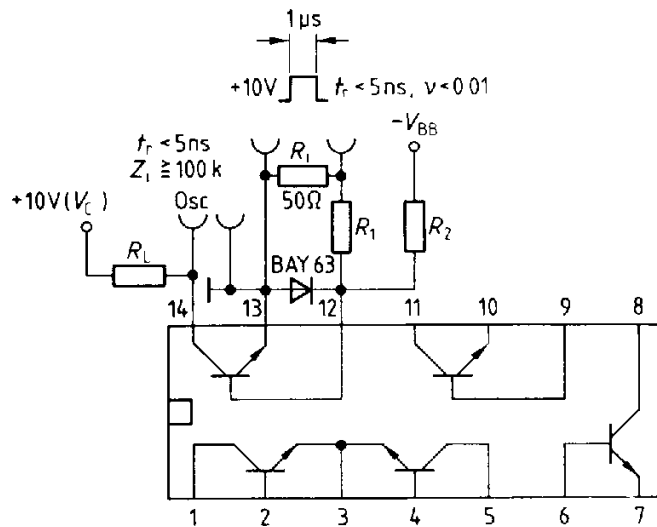

Switching Times

I_C I_{B1} $-I_{B2} \approx 10 : 1 : 1$ mA; $R_1 = 5$ k Ω ; $R_2 = 5$ k Ω ; $V_{BB} = 3.5$ V; $R_L = 990$ Ω
 t_{ON} 85 (< 150) ns t_{OFF} 480 (< 800) ns

I_C : I_{B1} $-I_{B2} \approx 100 : 10 : 10$ mA, $R_1 = 500$ Ω ; $R_2 = 700$ Ω , $V_{BB} = 5$ V; $R_L = 98$ Ω
 t_{ON} 55 (< 150) ns t_{OFF} 450 (< 800) ns

Absolute Maximum Ratings

Parameter	Symbol	Limit Values		Unit
		TCA 671 TCA 971	TCA 871 TCA 991	
Collector-base breakdown voltage	V_{CB0}	45	35	V
Collector-emitter breakdown voltage	V_{CE0}	42	32	V
Emitter-base breakdown voltage	V_{EB0}	6	6	V
Collector-substrate voltage ($I_C = 100 \mu\text{A}$)	V_{CS}	70	60	V
Collector current	I_C	200	200	mA
Base current	I_B	10	10	mA
Permissible power dissipation for a single transistor	P_{tot}	300	300	mW
Junction temperature	T_J	150	150	°C
Storage temperature range	T_{stg}	-40 to 125	-40 to 125	°C
Thermal resistance system - air	$R_{th SA}$	85	85	K/W
TCA 671 G; TCA 871 G; TCA 971 G; TCA 991 G	$R_{th SA}$	145	145	K/W

4

Operating Range

Ambient temperature	T_A	-25 to 85	-25 to 85	°C

Characteristics $T_A = 25^\circ\text{C}$

Parameter	Symbol	Limit Values TCA 671 TCA 971			Limit Values TCA 871 TCA 991			Unit
		min.	typ.	max.	min.	typ.	max.	
Differential base current for transistors T1 = T2 at $V_{CE} = 3 \text{ V}$, $I_C = 1 \text{ mA}$	I_{BD}		0.5	1		1		μA
Base-emitter voltage at $V_{CE} = 3 \text{ V}$, $I_C = 1 \text{ mA}$	V_{BE}		0.65			0.65		V
Differential base-emitter voltage for transistors T1 + T2 at $V_{CE} = 3 \text{ V}$, $I_C = 1 \text{ mA}$	V_{BED}		2	5		4		mV
Differential base-emitter voltage for transistors T3 to T5 at $V_{CE} = 3 \text{ V}$, $I_C = 1 \text{ mA}$	V_{BED}		4	10		6		mV
Temperature coefficient of base-emitter voltage at $V_{CE} = 3 \text{ V}$, $I_C = 1 \text{ mA}$	$\frac{\Delta V_{BE}}{\Delta T}$		-2			-2		mV/K
Transition frequency	f_T	300	550		300	550		MHz

Characteristics $T_A = 25^\circ\text{C}$

Parameter	Symbol	Limit Values TCA 671 TCA 971			Limit Values TCA 871 TCA 991			Unit
		min.	typ.	max.	min.	typ.	max.	
Collector-base breakdown voltage at $I_C = 100\ \mu\text{A}$, $I_E = 0$	V_{CB0}	45			35			V
Collector-emitter breakdown voltage at $I_C = 100\ \mu\text{A}$, $I_B = 0$	V_{CE0}	42			32			V
Collector-substrate breakdown voltage at $I_C = 100\ \mu\text{A}$, $I_{CS} = 0$	V_{CS}	70			60			V
Emitter-base breakdown voltage at $I_E = 100\ \mu\text{A}$, $I_C = 0$	V_{EB0}	6			6			V
Collector-emitter saturation voltage at $I_C = 50\ \text{mA}$; $I_B = 5\ \text{mA}$	$V_{CE\ \text{Sat}}$		200	350		200	350	mV
Collector-base cutoff current at $V_{CB} = 25\ \text{V}$, $I_E = 0$	I_{CB0}		0.02	1		0.02	10	μA
Collector-emitter cutoff current at $V_{CE} = 25\ \text{V}$, $I_B = 0$	I_{CE0}			1			10	μA
Static current gain at $V_{CE} = 3\ \text{V}$, $I_C = 100\ \mu\text{A}$	B	40	80		40	80		
at $V_{CE} = 3\ \text{V}$, $I_C = 1\ \text{mA}$		100	140		100	140		
at $V_{CE} = 3\ \text{V}$, $I_C = 10\ \text{mA}$		100	160		100	160		
at $V_{CE} = 3\ \text{V}$, $I_C = 100\ \text{mA}$		40	100		40	100		

T-43-25

Current gain versus collector current
 $V_{CE} = 3 \text{ V}, T_A = 25^\circ\text{C}$

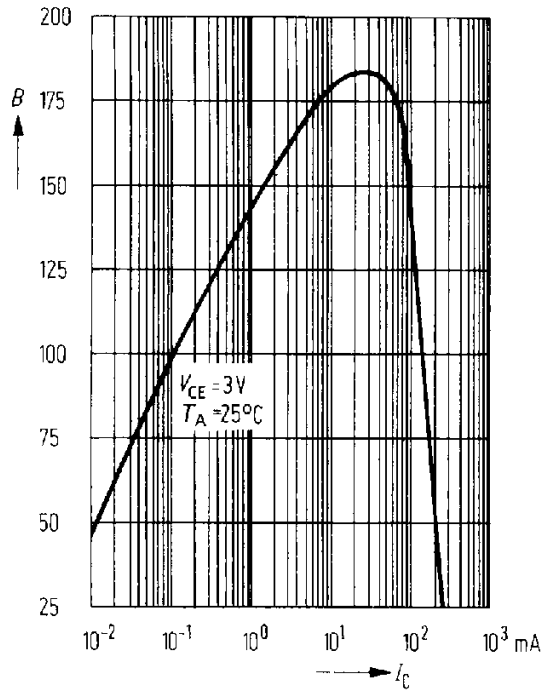

Transition frequency versus collector current
 $V_{CE} = 3 \text{ V}, T_A = 25^\circ\text{C}$

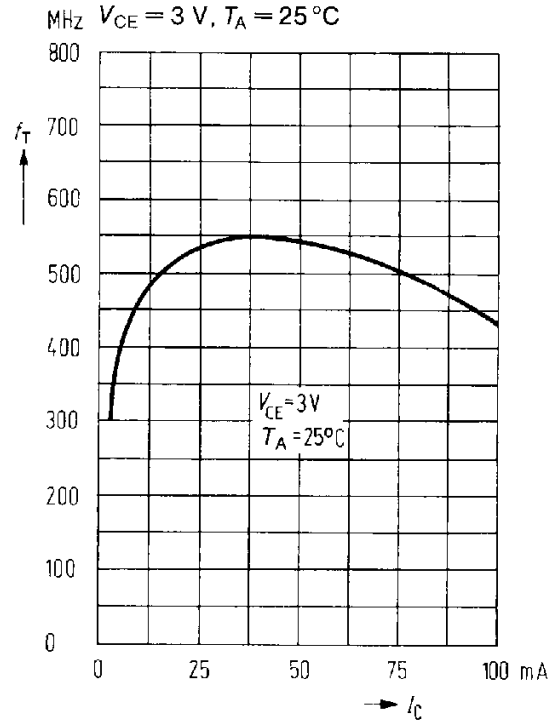

4

Collector-emitter saturation voltage versus collector current
 $B = 20$

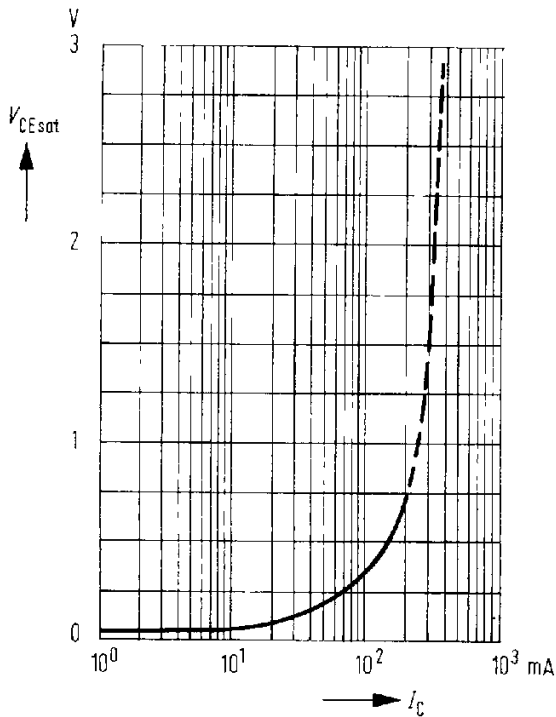

Base-emitter voltage versus input current
 $V_{CE} = 3 \text{ V}; T_A = 25^\circ\text{C}$

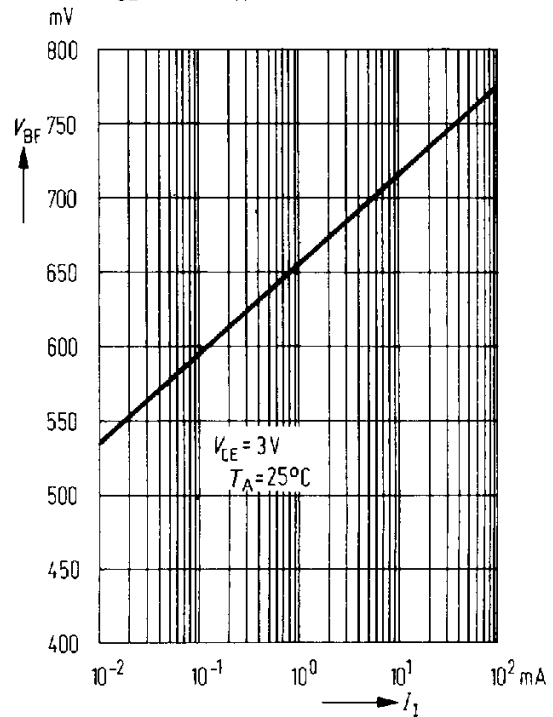

Output characteristics
Collector current versus
collector-emitter voltage
 $I_B = \text{parameter}$
 (common emitter configuration)

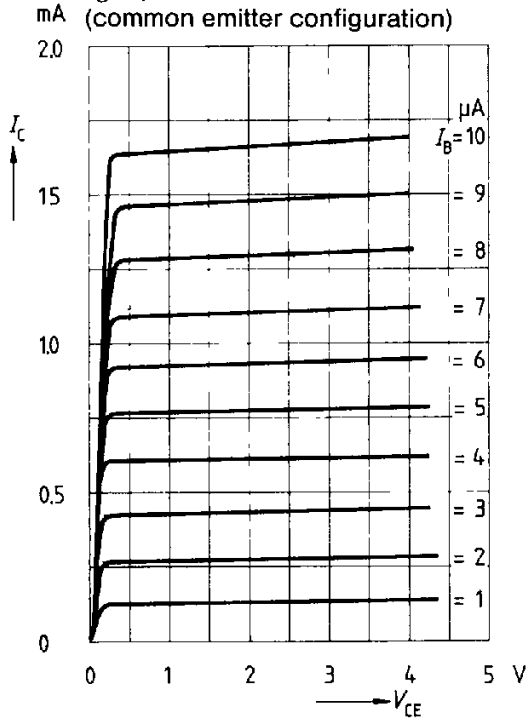

Output characteristics
Collector current versus
collector-emitter voltage
 $I_B = \text{parameter}$
 (common emitter configuration)

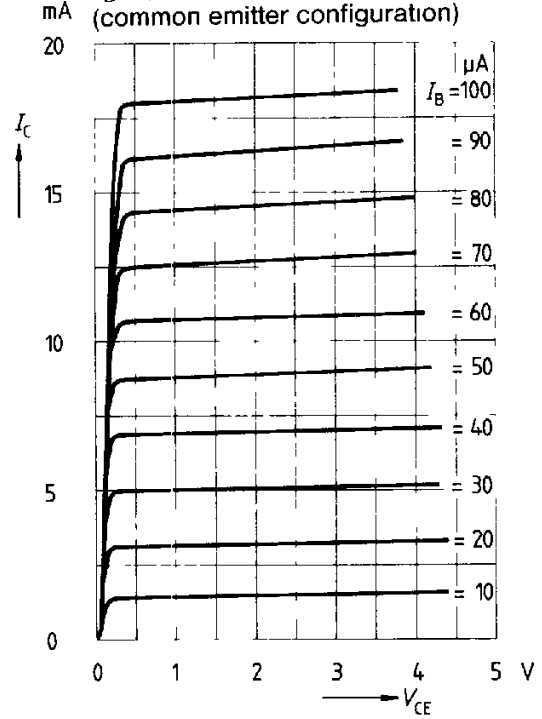

Output characteristics
Collector current versus
collector-emitter voltage
 $I_B = \text{parameter}$
 (common emitter configuration)

