

LMP7731

2.9 nV/sqrt(Hz) Low Noise, Precision, RRIO, Operational Amplifier in SOT23-5

General Description

The LMP7731 is a single, low noise, low offset voltage, rail-to-rail input and output, low voltage precision amplifier. The LMP7731 is part of the LMP® precision amplifier family and is ideal for precision and low noise applications with low voltage requirements.

This operational amplifier offers low voltage noise of 2.9 nV/√Hz with a 1/f corner of only 3 Hz and low DC offset with a maximum value of ±40 μV, targeting high accuracy, low frequency applications. The LMP7731 has bipolar input stages with a bias current of only 1.5 nA. This low input bias current, complemented by the very low AC and DC levels of voltage noise, makes the LMP7731 an excellent choice for photometry applications.

The LMP7731 provides a wide GBW of 22 MHz while consuming only 2 mA of current. This high gain bandwidth along with the high open loop gain of 130 dB enables accurate signal conditioning in applications with high closed loop gain requirements.

The LMP7731 has a supply voltage range of 1.8V to 5.5V, making it an ideal choice for battery operated portable applications.

The LMP7731 is offered in a 5-pin SOT23 package.

Features

(Typical values, $T_A = 25^\circ\text{C}$, $V_S = 5\text{V}$)

- Input voltage noise
 - $f = 3\text{ Hz}$ 3.3 nV/√Hz
 - $f = 1\text{ kHz}$ 2.9 nV/√Hz
- Offset voltage (max) ±40 μV
- Offset voltage drift (max) ±1.0 μV/°C
- CMRR 130 dB
- Open loop gain 130 dB
- GBW 22 MHz
- Slew rate 2.4 V/μs
- THD @ $f = 10\text{ kHz}$, $A_V = +1$, $R_L = 2\text{ k}\Omega$ 0.001%
- Supply current per channel 2.2 mA
- Supply voltage range 1.8V to 5.5V
- Operating temperature range -40°C to 125°C
- Input bias current ±1.5 nA
- RRIO
- 5-Pin SOT23 package

Applications

- Thermopile amplifier
- Gas analysis instruments
- Photometric instrumentation
- Medical instrumentation

Typical Application

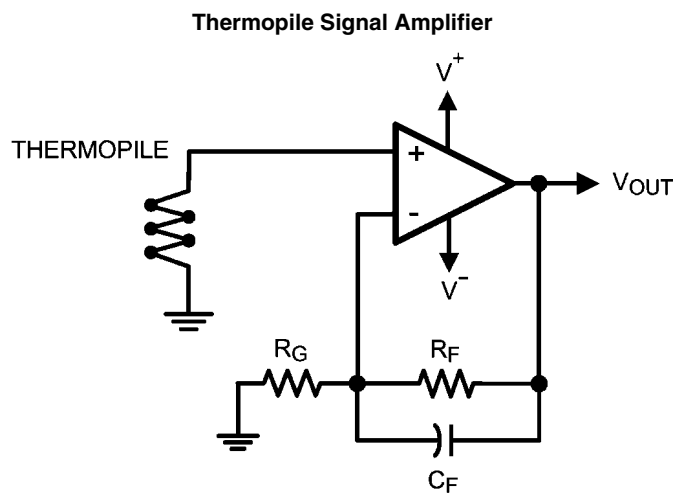

20175201

Absolute Maximum Ratings (Note 1)

If Military/Aerospace specified devices are required, please contact the National Semiconductor Sales Office/ Distributors for availability and specifications.

ESD Tolerance (Note 2)

Human Body Model

Inputs pins only

2000V

All other pins

2000V

Machine Model

200V

Charge Device Model

1000V

 V_{IN} Differential $\pm 2V$ Supply Voltage ($V_S = V^+ - V^-$)

6.0V

Storage Temperature Range

-65°C to 150°C

Junction Temperature (Note 3)

+150°C max

Soldering Information

Infrared or Convection (20 sec)

235°C

Wave Soldering Lead Temp. (10 sec)

260°C

Operating Ratings (Note 1)

Temperature Range

-40°C to 125°C

Supply Voltage ($V_S = V^+ - V^-$)

1.8V to 5.5V

Package Thermal Resistance (θ_{JA})

5-Pin SOT23

265°C/W

2.5V Electrical Characteristics (Note 4)

Unless otherwise specified, all limits are guaranteed for $T_A = 25^\circ\text{C}$, $V^+ = 2.5\text{V}$, $V^- = 0\text{V}$, $V_{CM} = V^+/2$, $R_L > 10\text{ k}\Omega$ to $V^+/2$. **Bold-face** limits apply at the temperature extremes.

Symbol	Parameter	Conditions	Min (Note 6)	Typ (Note 5)	Max (Note 6)	Units
V_{OS}	Input Offset Voltage (Note 7)	$V_{CM} = 2.0\text{V}$		± 9	± 50 ± 120	μV
		$V_{CM} = 0.5\text{V}$		± 9	± 40 ± 100	
TCV_{OS}	Input Offset Voltage Drift	$V_{CM} = 2.0\text{V}$		± 0.5	± 1.0	$\mu\text{V}/^\circ\text{C}$
		$V_{CM} = 0.5\text{V}$		± 0.2	± 0.8	
	Input Offset Voltage Time Drift	$V_{CM} = 0.5\text{V}$ and $V_{CM} = 2.0\text{V}$		0.35		$\mu\text{V}/\text{month}$
I_B	Input Bias Current	$V_{CM} = 2.0\text{V}$		± 1	± 30 ± 45	nA
		$V_{CM} = 0.5\text{V}$		± 12	± 50 ± 75	
I_{OS}	Input Offset Current	$V_{CM} = 2.0\text{V}$		± 1	± 50 ± 75	nA
		$V_{CM} = 0.5\text{V}$		± 11	± 60 ± 80	
TCI_{OS}	Input Offset Current Drift	$V_{CM} = 0.5\text{V}$ and $V_{CM} = 2.0\text{V}$		0.0474		nA/ $^\circ\text{C}$
CMRR	Common Mode Rejection Ratio	$0.15\text{V} \leq V_{CM} \leq 0.7\text{V}$	101	120		dB
		$0.23\text{V} \leq V_{CM} \leq 0.7\text{V}$	89			
		$1.5\text{V} \leq V_{CM} \leq 2.35\text{V}$	105	129		
		$1.5\text{V} \leq V_{CM} \leq 2.27\text{V}$	99			
PSRR	Power Supply Rejection Ratio	$2.5\text{V} \leq V^+ \leq 5\text{V}$	111 105	129		dB
		$1.8\text{V} \leq V^+ \leq 5.5\text{V}$		117		
CMVR	Input Common-Mode Voltage Range	Large Signal CMRR $\geq 80\text{ dB}$	0		2.5	V
A_{VOL}	Large Signal Voltage Gain	$R_L = 10\text{ k}\Omega$ to $V^+/2$ $V_O = 0.5\text{V}$ to 2.0V	112 104	130		dB
		$R_L = 2\text{ k}\Omega$ to $V^+/2$ $V_O = 0.5\text{V}$ to 2.0V	109 90	119		

Symbol	Parameter	Conditions	Min (Note 6)	Typ (Note 5)	Max (Note 6)	Units
V _O	Output Swing High	R _L = 10 kΩ to V ₊₂		4	50 75	mV from either rail
		R _L = 2 kΩ to V ₊₂		13	50 75	
	Output Swing Low	R _L = 10 kΩ to V ₊₂		6	50 75	
		R _L = 2 kΩ to V ₊₂		9	50 75	
I _O	Output Short Circuit Current	Sourcing, V _O = V ₊₂ V _{IN} (diff) = 100 mV	22 12	31		mA
		Sinking, V _O = V ₊₂ V _{IN} (diff) = -100 mV	15 10	44		
I _S	Supply Current (Per Channel)	V _{CM} = 2.0V		2.0	2.7 3.4	mA
		V _{CM} = 0.5V		2.3	3.1 3.9	
SR	Slew Rate	A _V = +1, C _L = 10 pF, R _L = 10 kΩ to V ₊₂ , V _O = 2 V _{PP}		2.4		V/μs
GBW	Gain Bandwidth Product	C _L = 20 pF, R _L = 10 kΩ to V ₊₂		21		MHz
G _M	Gain Margin	C _L = 20 pF, R _L = 10 kΩ to V ₊₂		14		dB
Φ _M	Phase Margin	C _L = 20 pF, R _L = 10 kΩ to V ₊₂		60		deg
R _{IN}	Input Resistance	Differential Mode		38		kΩ
		Common Mode		151		MΩ
THD+N	Total Harmonic Distortion	A _V = 1, f = 1 kHz, Amplitude = 1V		0.002		%
e _n	Input-Referred Voltage Noise	f = 1 kHz, V _{CM} = 2.0V		3		nV/√Hz
		f = 1 kHz, V _{CM} = 0.5V		3		
	0.1 Hz to 10 Hz			75		nV _{PP}
i _n	Input-Referred Current Noise	f = 1 kHz, V _{CM} = 2.0V		1.1		pA/√Hz
		f = 1 kHz, V _{CM} = 0.5V		2.3		

3.3V Electrical Characteristics (Note 4)

Unless otherwise specified, all limits are guaranteed for T_A = 25°C, V₊ = 3.3V, V₋ = 0V, V_{CM} = V₊₂, R_L > 10 kΩ to V₊₂. **Bold-face** limits apply at the temperature extremes.

Symbol	Parameter	Conditions	Min (Note 6)	Typ (Note 5)	Max (Note 6)	Units
V _{OS}	Input Offset Voltage (Note 7)	V _{CM} = 2.5V		±6	±50 ±120	μV
		V _{CM} = 0.5V		±6	±40 ±100	
TCV _{OS}	Input Offset Voltage Drift	V _{CM} = 2.5V		±0.5	±1.0	μV/°C
		V _{CM} = 0.5V		±0.2	±0.8	
	Input Offset Voltage Time Drift	V _{CM} = 0.5V and V _{CM} = 2.5V		0.35		μV/month
I _B	Input Bias Current	V _{CM} = 2.5V		±1.5	±30 ±45	nA
		V _{CM} = 0.5V		±13	±50 ±77	
I _{OS}	Input Offset Current	V _{CM} = 2.5V		±1	±50 ±70	nA
		V _{CM} = 0.5V		±11	±60 ±80	

Symbol	Parameter	Conditions	Min (Note 6)	Typ (Note 5)	Max (Note 6)	Units
TCI_{OS}	Input Offset Current Drift	$V_{CM} = 0.5V$ and $V_{CM} = 2.5V$		0.048		nA/°C
CMRR	Common Mode Rejection Ratio	$0.15V \leq V_{CM} \leq 0.7V$ $0.23V \leq V_{CM} \leq 0.7V$	101 89	120		dB
		$1.5V \leq V_{CM} \leq 3.15V$ $1.5V \leq V_{CM} \leq 3.07V$	105 99	130		
PSRR	Power Supply Rejection Ratio	$2.5V \leq V^+ \leq 5.0V$	111 105	129		dB
		$1.8V \leq V^+ \leq 5.5V$		117		
CMVR	Input Common-Mode Voltage Range	Large Signal CMRR ≥ 80 dB	0		3.3	V
A_{VOL}	Large Signal Voltage Gain	$R_L = 10$ k Ω to $V^+/2$ $V_O = 0.5V$ to $2.8V$	112 104	130		dB
		$R_L = 2$ k Ω to $V^+/2$ $V_O = 0.5V$ to $2.8V$	110 92	119		
V_O	Output Swing High	$R_L = 10$ k Ω to $V^+/2$		5	50 75	mV from either rail
		$R_L = 2$ k Ω to $V^+/2$		14	50 75	
	Output Swing Low	$R_L = 10$ k Ω to $V^+/2$		9	50 75	
		$R_L = 2$ k Ω to $V^+/2$		13	50 75	
I_O	Output Short Circuit Current	Sourcing, $V_O = V^+/2$ V_{IN} (diff) = 100 mV	28 22	45		mA
		Sinking, $V_O = V^+/2$ V_{IN} (diff) = -100 mV	25 20	48		
I_S	Supply Current (Per Channel)	$V_{CM} = 2.5V$		2.1	2.8 3.5	mA
		$V_{CM} = 0.5V$		2.4	3.2 4.0	
SR	Slew Rate	$A_V = +1$, $C_L = 10$ pF, $R_L = 10$ k Ω to $V^+/2$, $V_O = 2 V_{PP}$		2.4		V/ μ s
GBW	Gain Bandwidth Product	$C_L = 20$ pF, $R_L = 10$ k Ω to $V^+/2$		22		MHz
G_M	Gain Margin	$C_L = 20$ pF, $R_L = 10$ k Ω to $V^+/2$		14		dB
Φ_M	Phase Margin	$C_L = 20$ pF, $R_L = 10$ k Ω to $V^+/2$		62		deg
R_{IN}	Input Resistance	Differential Mode		38		k Ω
		Common Mode		151		M Ω
THD+N	Total Harmonic Distortion	$A_V = 1$, $f = 1$ kHz, Amplitude = 1V,		0.002		%
e_n	Input-Referred Voltage Noise	$f = 1$ kHz, $V_{CM} = 2.5V$		2.9		nV/ \sqrt{Hz}
		$f = 1$ kHz, $V_{CM} = 0.5V$		2.9		
	0.1 Hz to 10 Hz			65		nV $_{PP}$
i_n	Input-Referred Current Noise	$f = 1$ kHz, $V_{CM} = 2.5V$		1.1		pA/ \sqrt{Hz}
		$f = 1$ kHz, $V_{CM} = 0.5V$		2.1		

5V Electrical Characteristics (Note 4)

Unless otherwise specified, all limits are guaranteed for $T_A = 25^\circ\text{C}$, $V^+ = 5\text{V}$, $V^- = 0\text{V}$, $V_{\text{CM}} = V^+/2$, $R_L > 10\text{ k}\Omega$ to $V^+/2$. **Boldface** limits apply at the temperature extremes.

Symbol	Parameter	Conditions	Min (Note 6)	Typ (Note 5)	Max (Note 6)	Units
V_{OS}	Input Offset Voltage (Note 7)	$V_{\text{CM}} = 4.5\text{V}$		± 6	± 50 ± 120	μV
		$V_{\text{CM}} = 0.5\text{V}$		± 6	± 40 ± 100	
TCV_{OS}	Input Offset Voltage Drift	$V_{\text{CM}} = 4.5\text{V}$		± 0.5	± 1.0	$\mu\text{V}/^\circ\text{C}$
		$V_{\text{CM}} = 0.5\text{V}$		± 0.2	± 0.8	
	Input Offset Voltage Time Drift	$V_{\text{CM}} = 0.5\text{V}$ and $V_{\text{CM}} = 4.5\text{V}$		0.35		$\mu\text{V}/\text{month}$
I_{B}	Input Bias Current	$V_{\text{CM}} = 4.5\text{V}$		± 1.5	± 30 ± 50	nA
		$V_{\text{CM}} = 0.5\text{V}$		± 14	± 50 ± 85	
I_{OS}	Input Offset Current	$V_{\text{CM}} = 4.5\text{V}$		± 1	± 50 ± 70	nA
		$V_{\text{CM}} = 0.5\text{V}$		± 11	± 65 ± 80	
TCI_{OS}	Input Offset Current Drift	$V_{\text{CM}} = 0.5\text{V}$ and $V_{\text{CM}} = 4.5\text{V}$		0.0482		$\text{nA}/^\circ\text{C}$
CMRR	Common Mode Rejection Ratio	$0.15\text{V} \leq V_{\text{CM}} \leq 0.7\text{V}$	101	120		dB
		$0.23\text{V} \leq V_{\text{CM}} \leq 0.7\text{V}$	89			
		$1.5\text{V} \leq V_{\text{CM}} \leq 4.85\text{V}$	105	130		
		$1.5\text{V} \leq V_{\text{CM}} \leq 4.77\text{V}$	99			
PSRR	Power Supply Rejection Ratio	$2.5\text{V} \leq V^+ \leq 5\text{V}$	111 105	129		dB
		$1.8\text{V} \leq V^+ \leq 5.5\text{V}$		117		
CMVR	Input Common-Mode Voltage Range	Large Signal CMRR $\geq 80\text{ dB}$	0		5	V
A_{VOL}	Large Signal Voltage Gain	$R_L = 10\text{ k}\Omega$ to $V^+/2$ $V_O = 0.5\text{V}$ to 4.5V	112 104	130		dB
		$R_L = 2\text{ k}\Omega$ to $V^+/2$ $V_O = 0.5\text{V}$ to 4.5V	110 94	119		
V_O	Output Swing High	$R_L = 10\text{ k}\Omega$ to $V^+/2$		8	50 75	mV from either rail
		$R_L = 2\text{ k}\Omega$ to $V^+/2$		24	50 75	
	Output Swing Low	$R_L = 10\text{ k}\Omega$ to $V^+/2$		9	50 75	
		$R_L = 2\text{ k}\Omega$ to $V^+/2$		23	50 75	
I_O	Output Short Circuit Current	Sourcing, $V_O = V^+/2$ $V_{\text{IN}}(\text{diff}) = 100\text{ mV}$	33 27	47		mA
		Sinking, $V_O = V^+/2$ $V_{\text{IN}}(\text{diff}) = -100\text{ mV}$	30 25	49		
I_S	Supply Current (Per Channel)	$V_{\text{CM}} = 4.5\text{V}$		2.2	3.0 3.7	mA
		$V_{\text{CM}} = 0.5\text{V}$		2.5	3.4 4.2	
SR	Slew Rate	$A_V = +1$, $C_L = 10\text{ pF}$, $R_L = 10\text{ k}\Omega$ to $V^+/2$, $V_O = 2 V_{\text{PP}}$		2.4		$\text{V}/\mu\text{s}$

Symbol	Parameter	Conditions	Min (Note 6)	Typ (Note 5)	Max (Note 6)	Units
GBW	Gain Bandwidth Product	$C_L = 20 \text{ pF}$, $R_L = 10 \text{ k}\Omega$ to $V+/2$		22		MHz
G_M	Gain Margin	$C_L = 20 \text{ pF}$, $R_L = 10 \text{ k}\Omega$ to $V+/2$		12		dB
Φ_M	Phase Margin	$C_L = 20 \text{ pF}$, $R_L = 10 \text{ k}\Omega$ to $V+/2$		65		deg
R_{IN}	Input Resistance	Differential Mode		38		$\text{k}\Omega$
		Common Mode		151		$\text{M}\Omega$
THD+N	Total Harmonic Distortion	$A_V = 1$, $f = 1 \text{ kHz}$, Amplitude = 1V		0.001		%
e_n	Input-Referred Voltage Noise	$f = 1 \text{ kHz}$, $V_{CM} = 4.5\text{V}$		2.9		$\text{nV}/\sqrt{\text{Hz}}$
		$f = 1 \text{ kHz}$, $V_{CM} = 0.5\text{V}$		2.9		
		0.1 Hz to 10 Hz		78		nV_{PP}
i_n	Input-Referred Current Noise	$f = 1 \text{ kHz}$, $V_{CM} = 4.5\text{V}$		1.1		$\text{pA}/\sqrt{\text{Hz}}$
		$f = 1 \text{ kHz}$, $V_{CM} = 0.5\text{V}$		2.2		

Note 1: Absolute Maximum Ratings indicate limits beyond which damage to the device may occur. Operating Ratings indicate conditions for which the device is intended to be functional, but specific performance is not guaranteed. For guaranteed specifications and the test conditions, see the Electrical Characteristics Tables.

Note 2: Human Body Model, applicable std. MIL-STD-883, Method 3015.7. Machine Model, applicable std. JESD22-A115-A (ESD MM std. of JEDEC) Field-Induced Charge-Device Model, applicable std. JESD22-C101-C (ESD FICDM std. of JEDEC).

Note 3: The maximum power dissipation is a function of $T_{J(MAX)}$, θ_{JA} . The maximum allowable power dissipation at any ambient temperature is $P_D = (T_{J(MAX)} - T_A) / \theta_{JA}$. All numbers apply for packages soldered directly onto a PC Board.

Note 4: Electrical Table values apply only for factory testing conditions at the temperature indicated. Factory testing conditions result in very limited self-heating of the device such that $T_J = T_A$. No guarantee of parametric performance is indicated in the electrical tables under conditions of internal self-heating where $T_J > T_A$. Absolute maximum Ratings indicate junction temperature limits beyond which the device maybe permanently degraded, either mechanically or electrically.

Note 5: Typical values represent the most likely parametric norm as determined at the time of characterization. Actual typical values may vary over time and will also depend on the application and configuration. The typical values are not tested and are not guaranteed on shipped production material.

Note 6: All limits are guaranteed by testing, statistical analysis or design.

Note 7: Ambient production test is performed at 25°C with a variance of $\pm 3^\circ\text{C}$.

Connection Diagram

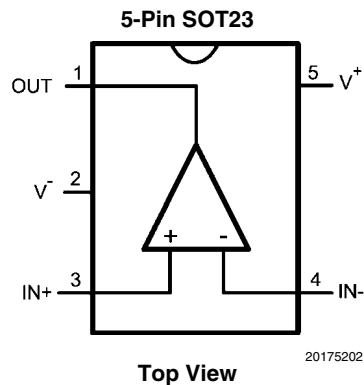

Ordering Information

Package	Part Number	Package Marking	Transport Media	NSC Drawing
5-Pin SOT23	LMP7731MF	AY3A	1k Units Tape and Reel	MF05A
	LMP7731MFX		3k Units Tape and Reel	

Typical Performance Characteristics Unless otherwise noted: $T_A = 25^\circ\text{C}$, $R_L > 10\text{ k}\Omega$, $V_{CM} = V_S/2$.

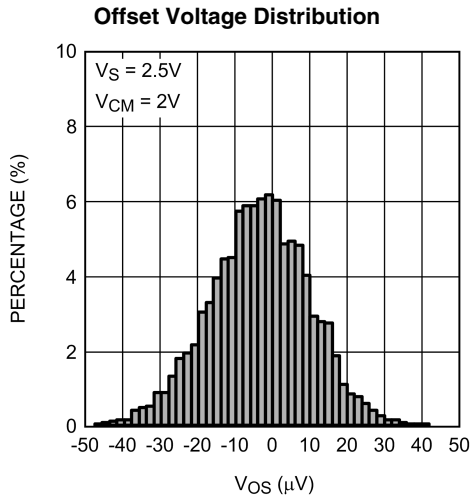

20175238

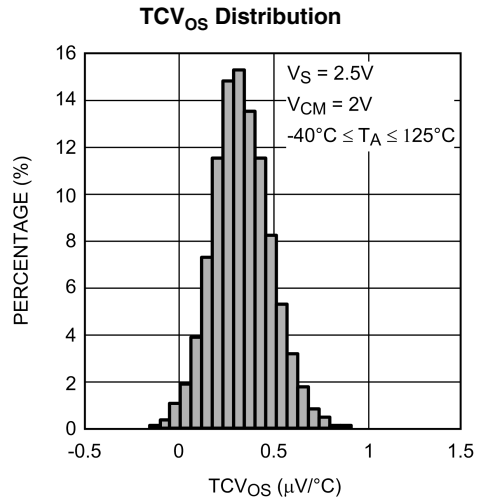

20175234

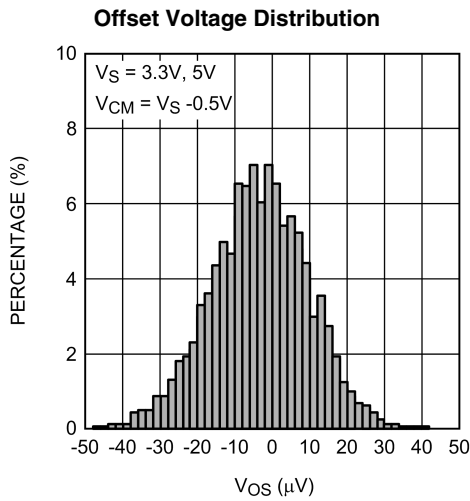

20175239

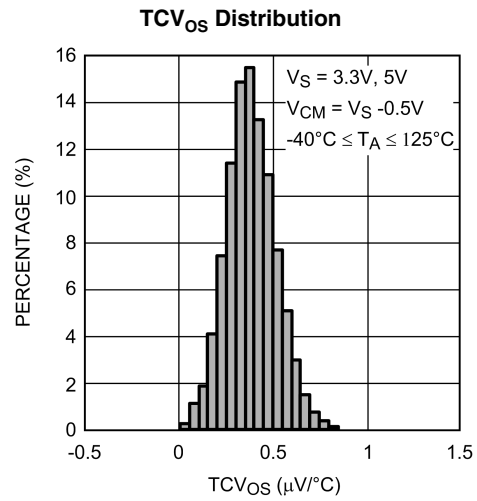

20175236

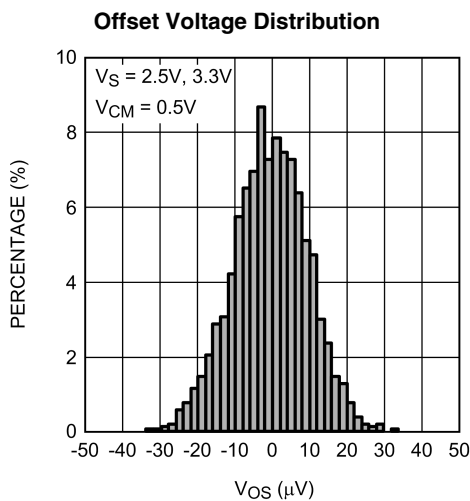

20175240

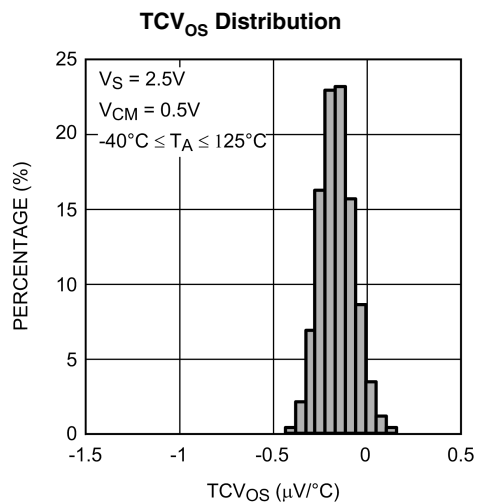

20175235

Offset Voltage Distribution

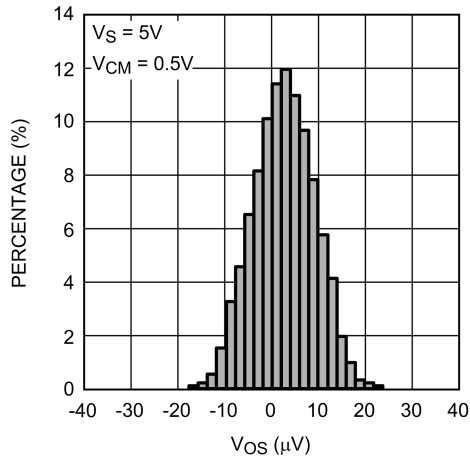

20175241

TCV_{OS} Distribution

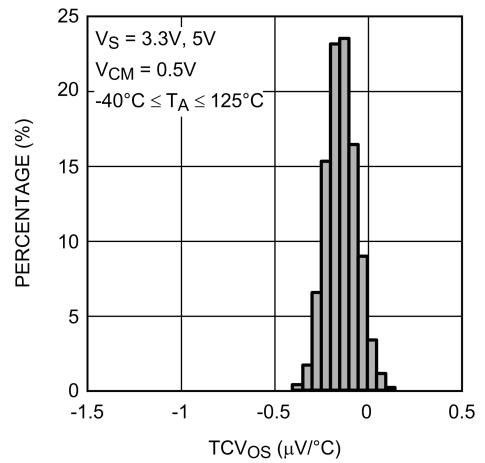

20175237

Offset Voltage vs. Temperature

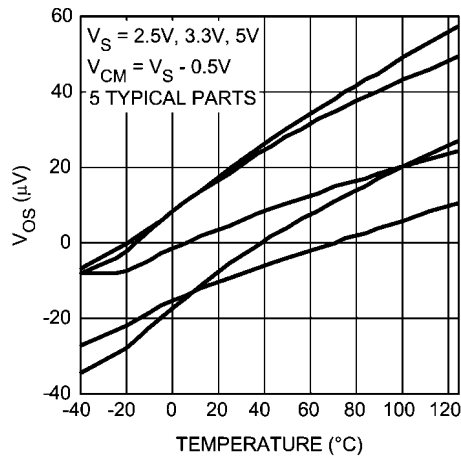

20175251

Offset Voltage vs. Temperature

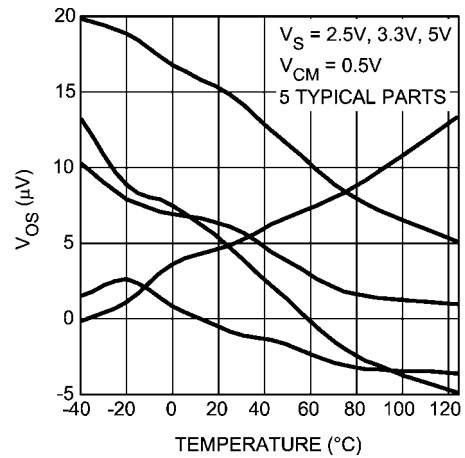

20175252

PSRR vs. Frequency

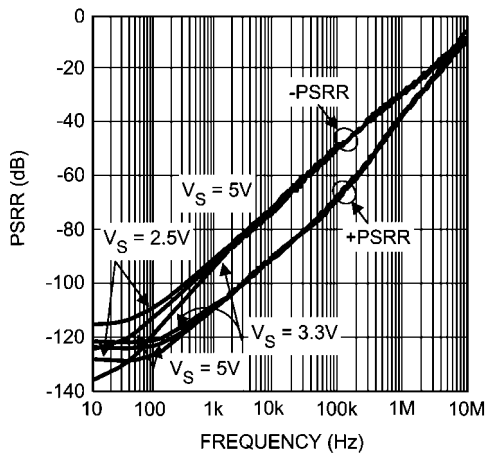

20175229

CMRR vs. Frequency

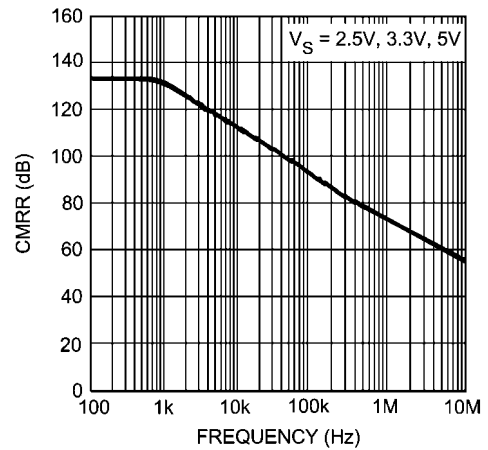

20175256

Offset Voltage vs. Supply Voltage

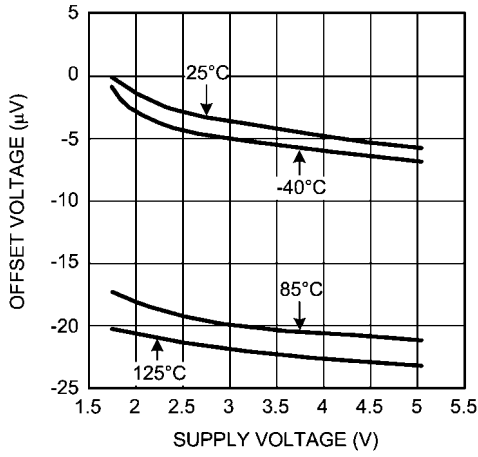

20175242

Offset Voltage vs. V_{CM}

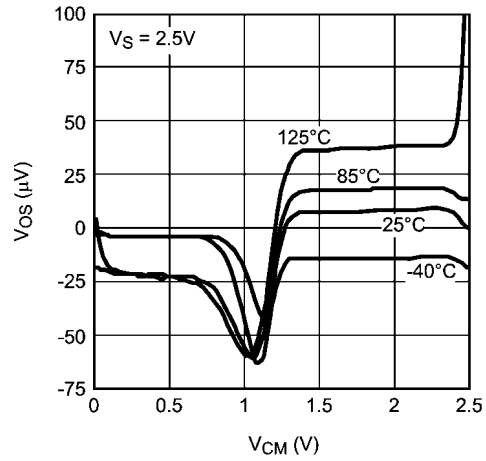

20175243

Offset Voltage vs. V_{CM}

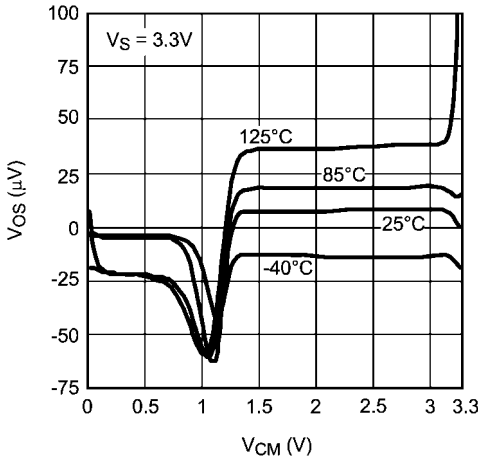

20175244

Offset Voltage vs. V_{CM}

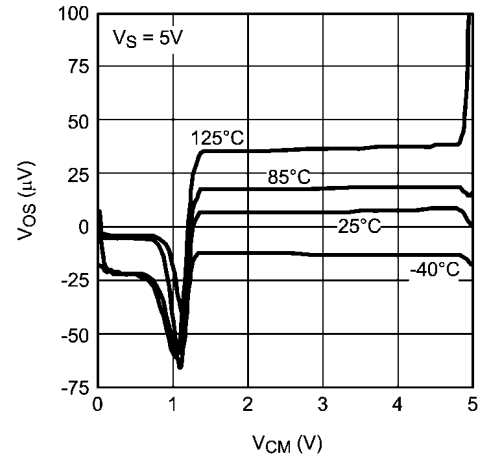

20175245

Input Offset Voltage Time Drift

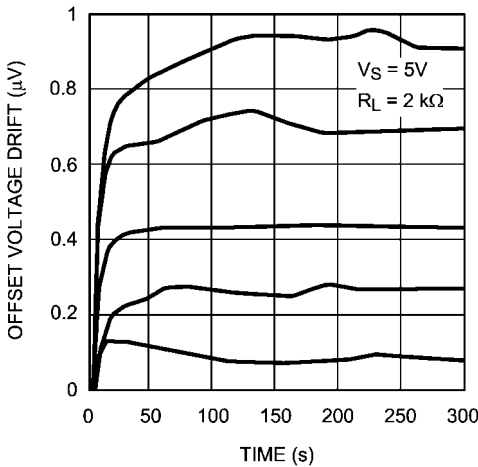

20175230

Slew Rate vs. Supply Voltage

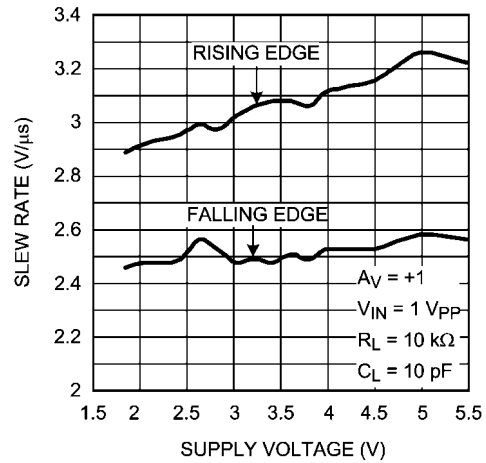

20175220

Input Voltage Noise vs. Frequency

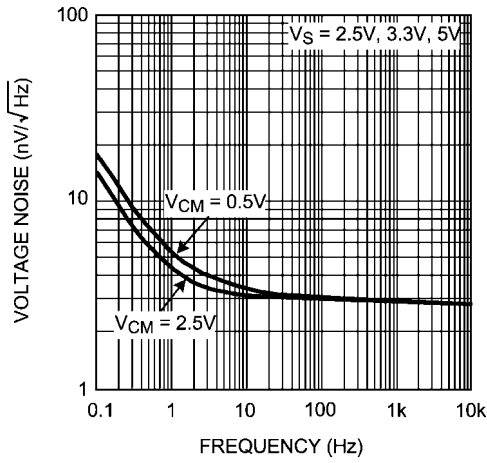

20175261

Input Current Noise vs. Frequency

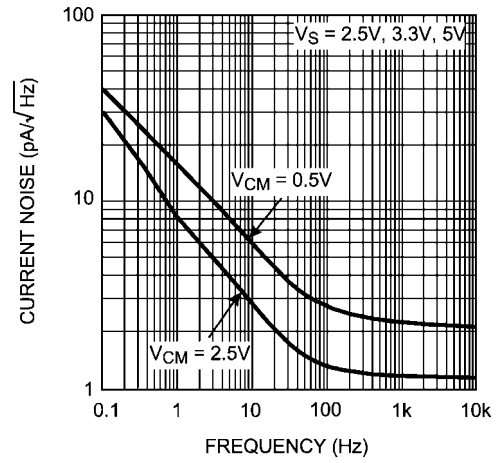

20175262

Time Domain Voltage Noise

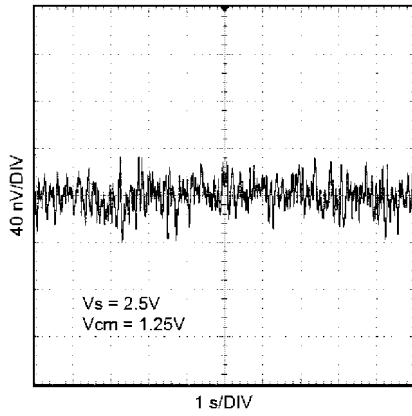

20175269

Time Domain Voltage Noise

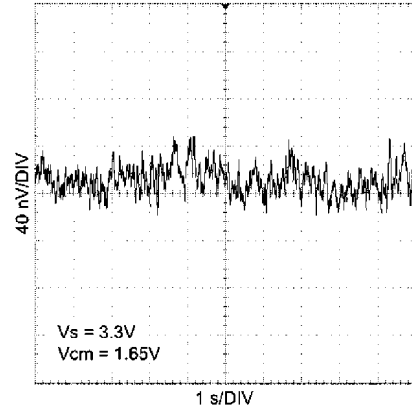

20175267

Time Domain Voltage Noise

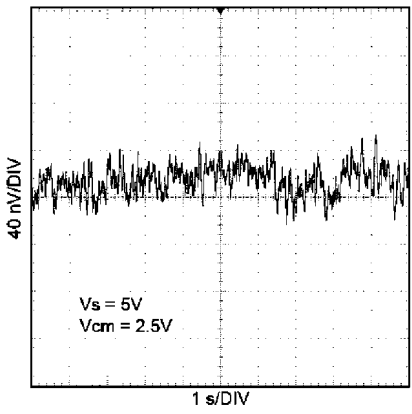

20175268

Output Voltage vs. Output Current

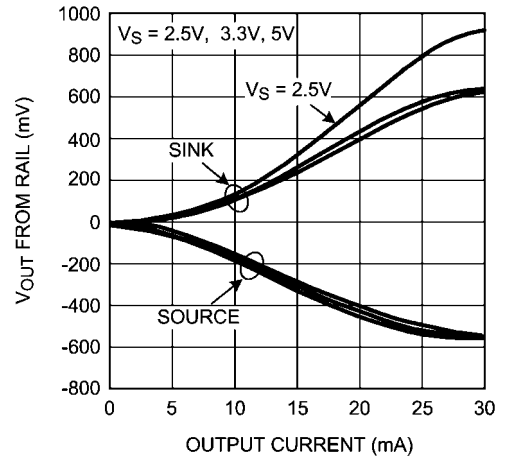

20175269

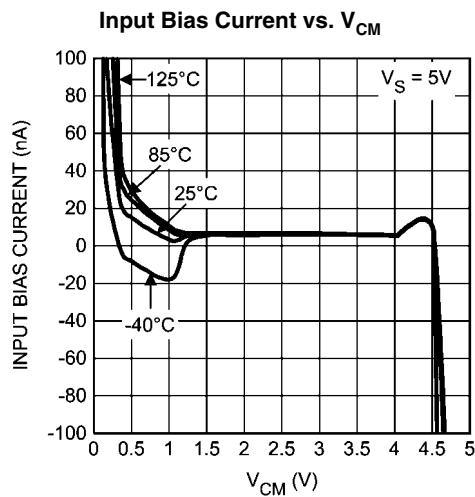
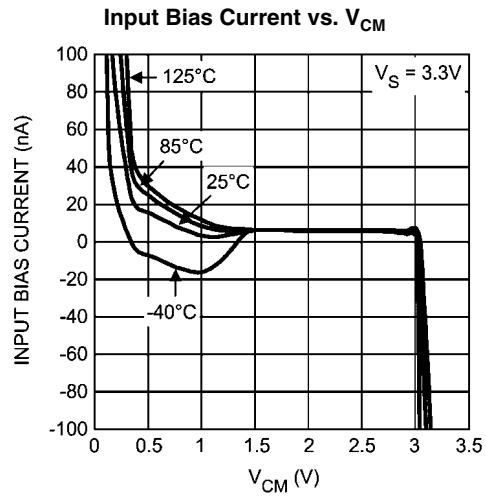
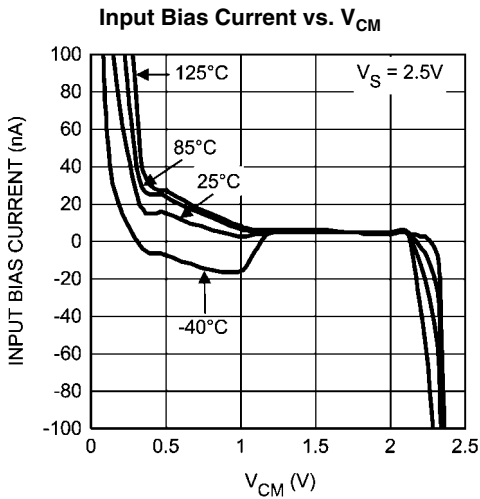

Open Loop Frequency Response Over Temperature

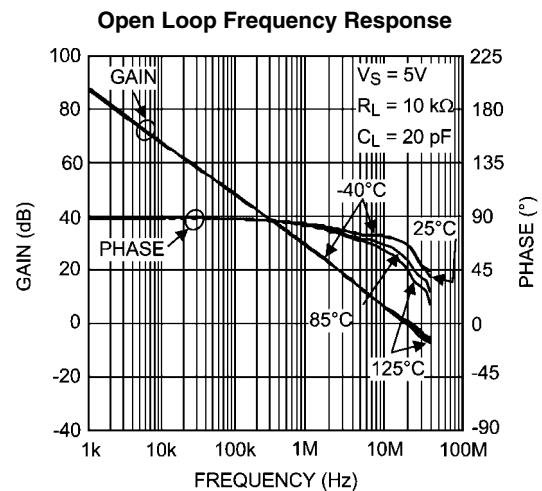
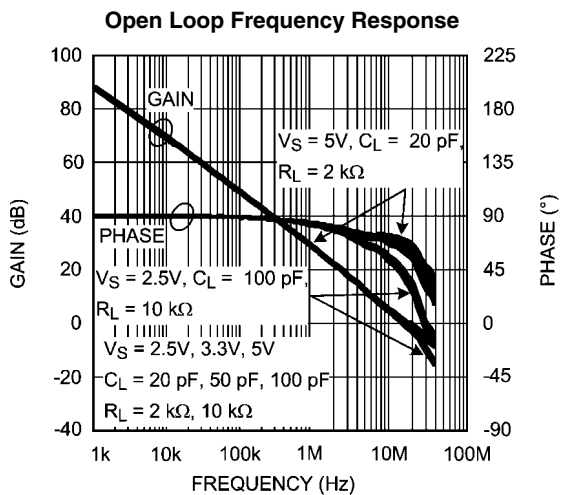
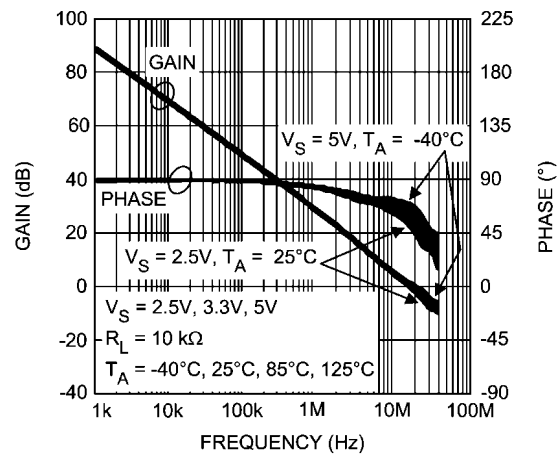

THD+N vs. Frequency

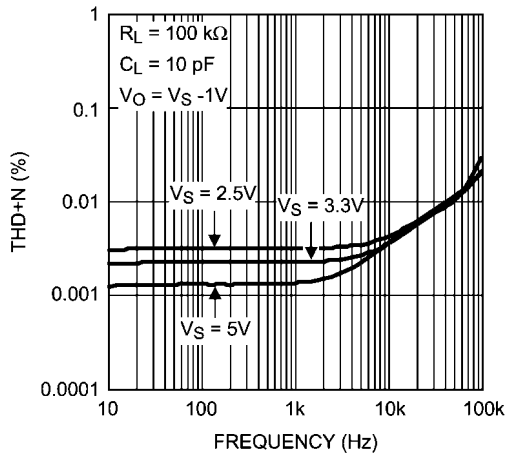

20175257

THD+N vs. Output Voltage

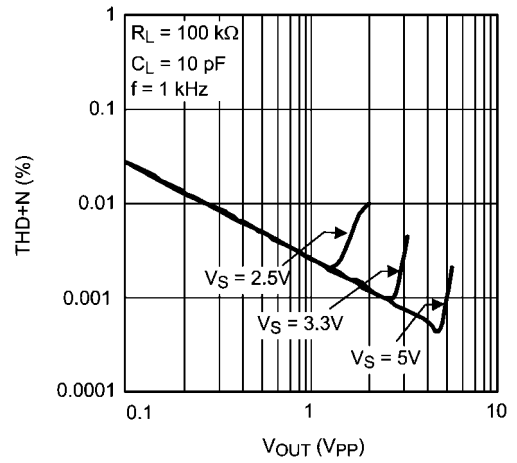

20175258

Large Signal Step Response

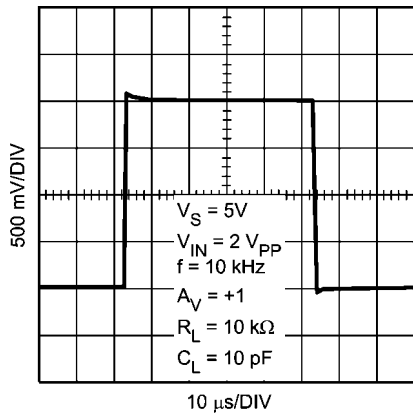

20175222

Small Signal Step Response

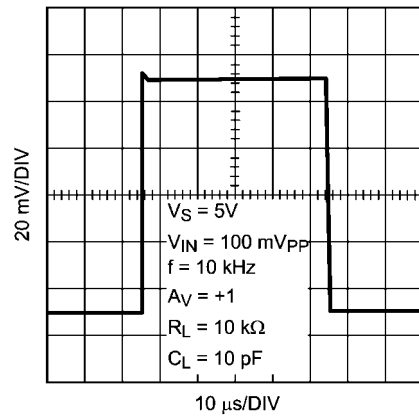

20175221

Large Signal Step Response

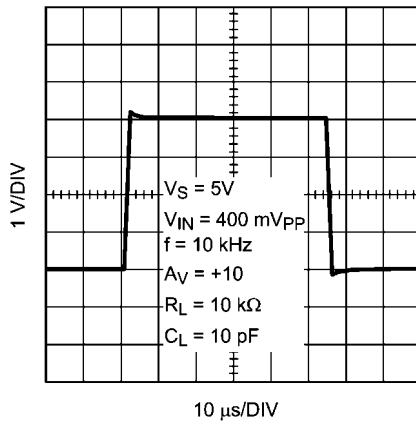

20175224

Small Signal Step Response

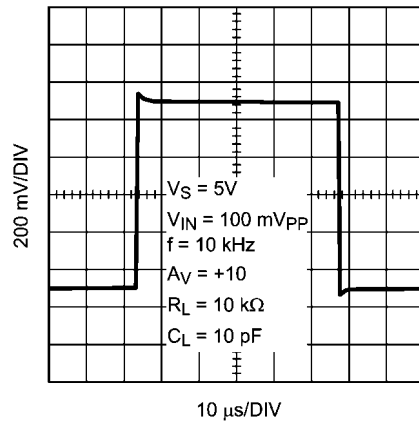

20175223

Supply Current vs. Supply Voltage

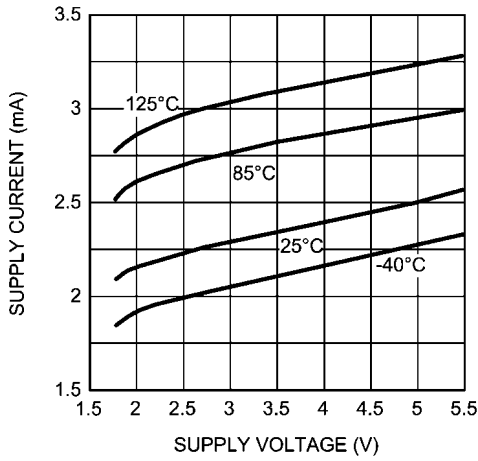

20175246

Output Swing High vs. Supply Voltage

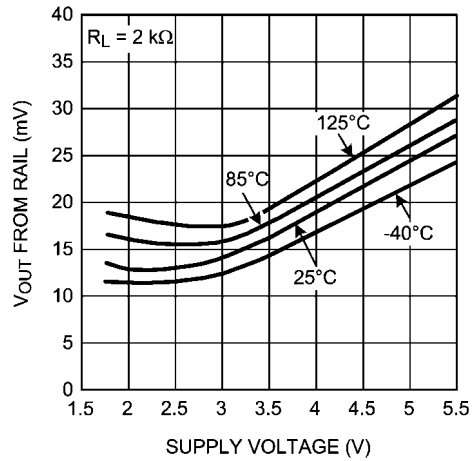

20175250

Output Swing Low vs. Supply Voltage

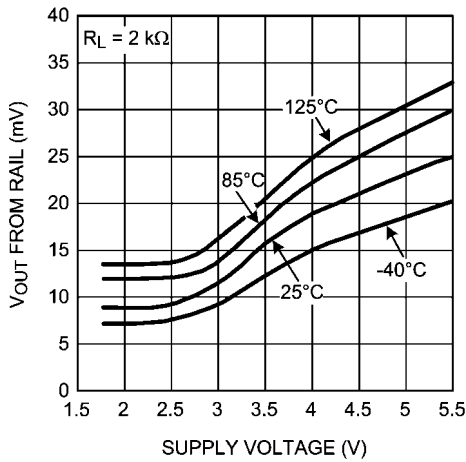

20175249

Sinking Current vs. Supply Voltage

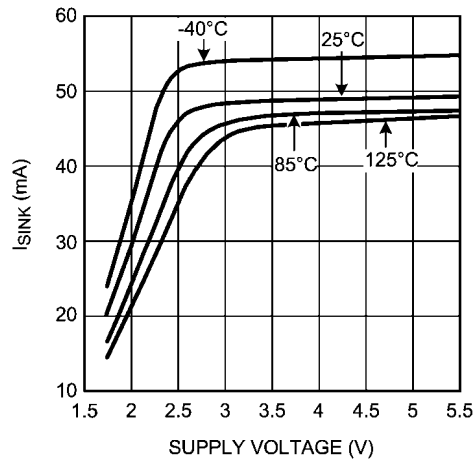

20175247

Sourcing Current vs. Supply Voltage

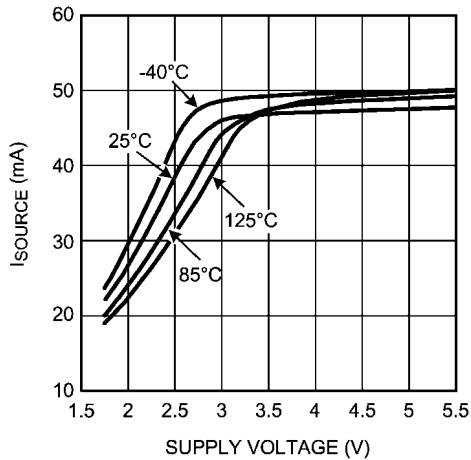

20175248

Application Information

LMP7731

The LMP7731 is a single, low noise, low offset voltage, rail-to-rail input and output, and low voltage precision amplifier.

The low input voltage noise of only $2.9 \text{ nV}/\sqrt{\text{Hz}}$ with a $1/f$ corner at 3 Hz makes the LMP7731 ideal for sensor applications where DC accuracy is of importance.

The LMP7731 has a very low guaranteed offset voltage of only $\pm 40 \mu\text{V}$. This low offset voltage along with the very low input voltage noise allows higher signal integrity and higher signal to noise ratios as the error contribution by the amplifier is at a minimum.

The LMP7731 has a high gain bandwidth of 22 MHz. This wide bandwidth enables use of the amplifier at higher gain settings while retaining usable bandwidth for the application. This is particularly beneficial when system designers need to use sensors with very limited output voltage range as it allows larger gains in one stage which in turn increases the signal to noise ratio.

The LMP7731 has proprietary input bias cancellation circuitry on the input stages. This allows the LMP7731 to have only about 1.5 nA bias current with a bipolar input stage. This low input bias current, paired with the inherent lower input voltage noise of bipolar input stages makes the LMP7731 an excellent choice for precision applications. The combination of low input bias current, low input offset voltage, and low input voltage noise enables the user to achieve unprecedented accuracy and higher signal integrity.

National Semiconductor is heavily committed to precision amplifiers and the market segment they serve. Technical support and extensive characterization data are available for sensitive applications or applications with a constrained error budget.

The LMP7731 is offered in the space saving 5-Pin SOT23 package. This small package is an ideal solution for area constrained PC boards and portable electronics.

INPUT BIAS CURRENT CANCELLATION

The LMP7731 has proprietary input bias current cancellation circuitry on their input stages.

The LMP7731 has rail-to-rail input. This is achieved by having two input stages in parallel. *Figure 1* shows only one of the input stages as the circuitry is symmetrical for both stages.

Figure 1 shows that as the common mode voltage gets closer to one of the extreme ends, current I_1 significantly increases. This increased current shows as an increase in voltage drop across resistor R_1 equal to $I_1 \cdot R_1$ on IN^+ of the amplifier. This voltage contributes to the offset voltage of the amplifier. When common mode voltage is in the mid-range, the transistors are operating in the linear region and I_1 is significantly small. The voltage drop due to I_1 across R_1 can be ignored as it is orders of magnitude smaller than the amplifier's input offset voltage. As the common mode voltage gets closer to one of the rails, the offset voltage generated due to I_1 increases and becomes comparable to the amplifiers offset voltage.

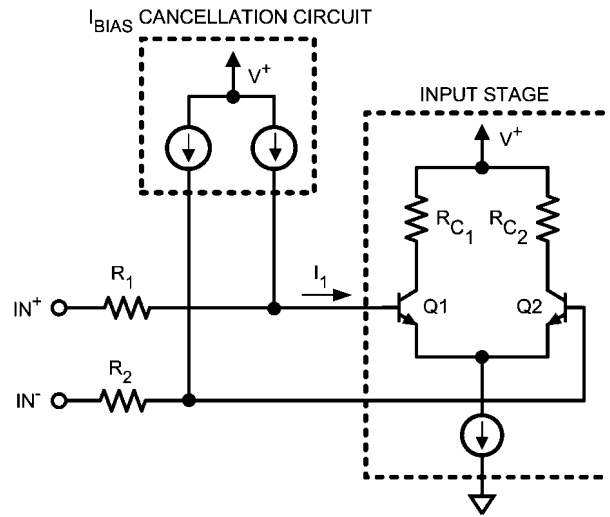

20175206

FIGURE 1. Input Bias Current Cancellation

INPUT VOLTAGE NOISE MEASUREMENT

The LMP7731 has very low input voltage noise. The peak-to-peak input voltage noise of the LMP7731 can be measured using the test circuit shown in *Figure 2*

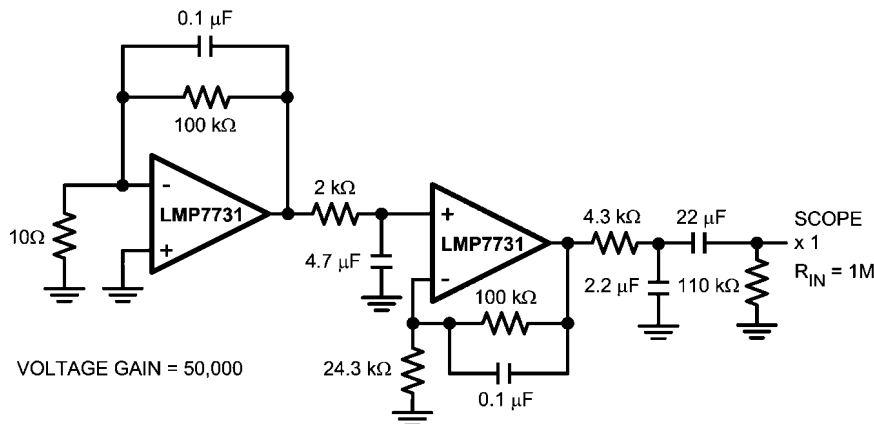

20175255

FIGURE 2. 0.1 Hz to 10 Hz Noise Test Circuit

The frequency response of this noise test circuit at the 0.1 Hz corner is defined by only one zero. The test time for the 0.1 Hz to 10 Hz noise measurement using this configuration should not exceed 10 seconds, as this time limit acts as an additional zero to reduce or eliminate the noise contributions of noise from frequencies below 0.1 Hz.

Figure 3 shows typical peak-to-peak noise for the LMP7731 measured with the circuit in Figure 2 for the LMP7731.

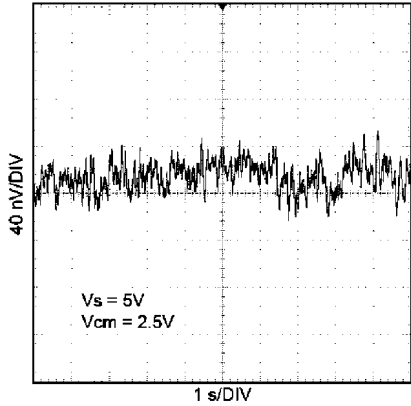

20175268

FIGURE 3. 0.1 Hz to 10 Hz Input Voltage Noise

Measuring the very low peak-to-peak noise performance of the LMP7731, requires special testing attention. In order to achieve accurate results, the device should be warmed up for at least five minutes. This is so that the input offset voltage of the op amp settles to a value. During this warm up period, the offset can typically change by a few μV because the chip temperature increases by about 30°C . If the 10 seconds of the measurement is selected to include this warm up time, some of this temperature change might show up as the measured noise. Figure 4 shows the start-up drift of five typical LMP7731 units.

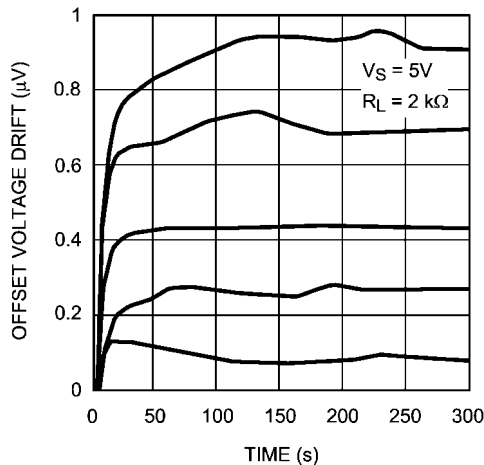

20175230

FIGURE 4. Start-Up Input Offset Voltage Drift

During the peak-to-peak noise measurement, the LMP7731 must be shielded. This prevents offset variations due to airflow. Offset can vary by a few nV due to this airflow and that can invalidate measurements of input voltage noise with a magnitude which is in the same range. For similar reasons, sudden motions must also be restricted in the vicinity of the test area. The feed-through which results from this motion could increase the observed noise value which in turn would invalidate the measurement.

DIODES BETWEEN THE INPUTS

The LMP7731 has a set of anti-parallel diodes between the input pins as shown in Figure 5. These diodes are present to protect the input stage of the amplifier. At the same time, they limit the amount of differential input voltage that is allowed on the input pins. A differential signal larger than the voltage needed to turn on the diodes might cause damage to the diodes. The differential voltage between the input pins should be limited to ± 3 diode drops or the input current needs to be limited to ± 20 mA.

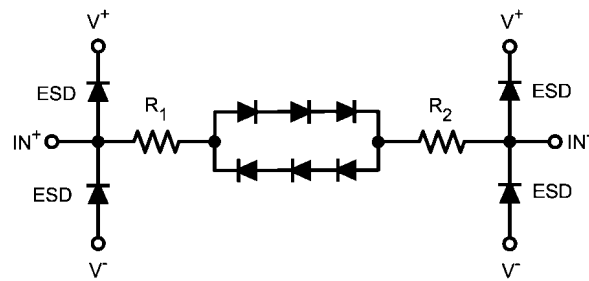

20175204

FIGURE 5. Anti-Parallel Diodes between Inputs

DRIVING AN ADC

Analog to Digital Converters, ADCs, usually have a sampling capacitor on their input. When the ADC's input is directly connected to the output of the amplifier a charging current flows from the amplifier to the ADC. This charging current causes a momentary glitch that can take some time to settle. There are different ways to minimize this effect. One way is to slow down the sampling rate. This method gives the amplifier sufficient time to stabilize its output. Another way to minimize the glitch caused by the switch capacitor is to have an external capacitor connected to the input of the ADC. This capacitor is chosen so that its value is much larger than the internal switching capacitor and it will hence provide the voltage needed to quickly and smoothly charge the ADC's sampling capacitor. Since this large capacitor will be loading the output of the amplifier as well, an isolation resistor is needed between the output of the amplifier and this capacitor. The isolation resistor, R_{ISO} , separates the additional load capacitance from the output of the amplifier and will also form a low-pass filter and can be designed to provide noise reduction as well as anti-aliasing. The drawback to having R_{ISO} is that it reduces signal swing since there is some voltage drop across it.

Figure 6 (a) shows the ADC directly connected to the amplifier. To minimize the glitch in this setting, a slower sample rate needs to be used. Figure 6 (b) shows R_{ISO} and an external capacitor used to minimize the glitch.

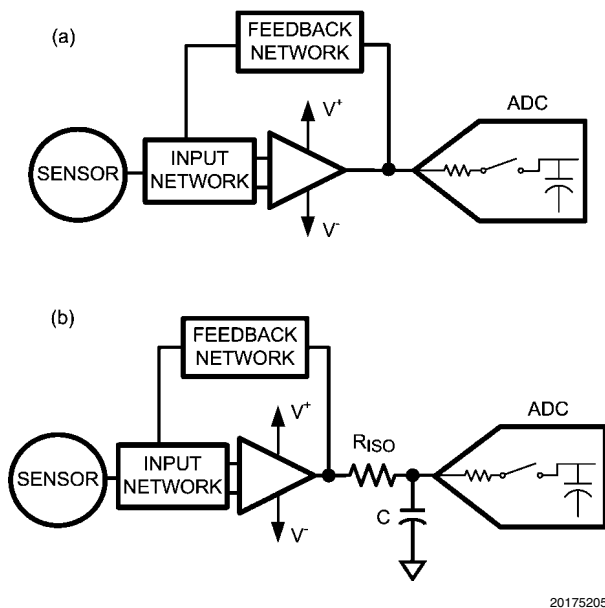

FIGURE 6. Driving an ADC

THERMOPILE AMPLIFIER

Thermopile Sensors

Thermopiles are arrays of interconnected thermocouples which can detect the surface temperature of an object through radiation rather than direct contact. The hot and cold junctions of the thermocouples are thermally isolated. The hot junctions are exposed to IR radiation emitted from the measurement surface and the cold junctions are connected to a heat sink. The incident IR changes the temperature of the hot junctions of the thermopile and produces an output voltage proportional to this change.

The hot junction of the thermopile is covered with a highly emissive coating. The IR radiation incident to this highly emissive material changes the temperature of this coating. The temperature change is converted to a voltage by the thermopile. Emissivity represents the radiation or absorption efficiency of a material relative to a black body. An ideal black body has an emissivity of 1.0. Excluding shiny metals, most objects have emissivities above 0.85. As a practical matter, shiny metals are not good candidates for IR sensing because of their low emissivity. The low emissivity means that the material is highly reflective. Reflective materials often "reflect" the temperature of their surrounding environment rather than their own heat radiation. This makes them not suitable for thermopile applications.

The output voltage of a thermopile is related to temperature and emissivity by the following formula:

$$V_{OUT} = K \left(\epsilon_{OBJ} \cdot T_{OBJ}^{4-\delta} - \epsilon_{TP} \cdot T_{TP}^{4-\delta} \right)$$

Where:

V_{OUT} : Output voltage of the thermopile

K : Proportionality constant

ϵ_{OBJ} : Emissivity of object being measured

T_{OBJ} : Temperature of object being measured

δ : Correction factor. (This is needed since thermopile filters do not allow all wavelengths to enter the sensor.)

ϵ_{TP} : Emissivity of the thermopile

T_{TP} : Temperature of the thermopile

As mentioned above, the IR radiation generates a static voltage across the pyroelectric material. If the illumination is constant, the signal level detection declines. This is why the radiation needs to be periodically refreshed. This task is usually achieved by the means of a mechanical chopper in front of the detector.

Thermopiles offer much faster response time compared to other temperature measurement devices. Packaged thermistors and thermocouples have response times that can range up to a few seconds, whereas packaged thermopiles can easily achieve response times in the order of tens of milliseconds. Thermopiles also provide superior thermal isolation compared to their contact temperature measurement counterparts. Physical contact disturbs the systems temperature and also creates temperature gradients.

Figure 7 shows a simplified schematic of a thermopile. The cold junctions are connected to a heat sink, and the absorber material covers the hot junction. The output voltage resulting from the temperature difference between the two junctions is measured at the two ends of the array of thermocouples. As is evident in Figure 7, increasing the number of thermocouples in a thermopile increases the output voltage range. This also increases the active area of the thermopile sensor.

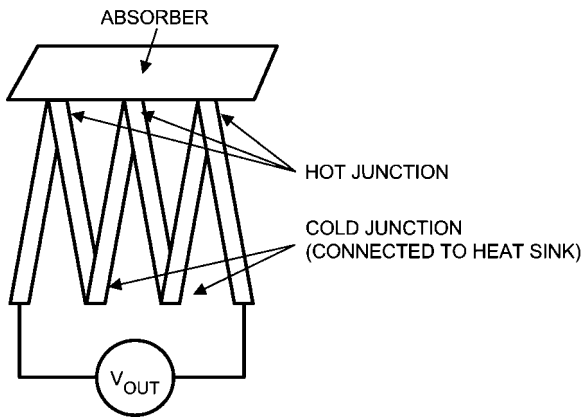

20175207

FIGURE 7. Thermopile

Thermopiles have very wide temperature ranges of -100°C to 1000°C

When choosing a thermopile for a certain application, one must pay attention to several parameters.

Thermopiles' sensitivity, or responsivity, is determined by the ratio of output voltage to the absorbed input signal power and is usually specified in V/W . Typical sensitivity of thermopiles ranges from 10s of V/W to about 100 V/W . Generally, higher values of sensitivity are desirable. Sensitivity is dependent on the absorber's area and number of thermocouples used in the sensor. Sensitivity is often represented by S where:

$$S = V_{\text{OUT}}/P_{\text{IN}}$$

The sensitivity of a thermopile varies with change in temperature. This change is usually specified as the Temperature Coefficient, TC, of sensitivity. Lower numbers are desired for this parameter.

Resistance of the thermopiles is usually specified in the datasheet. This is the impedance which will be seen by the input of the amplifier used to process the thermopile's output signal. Typical values for thermopile resistance, R_{TP} , range from 10s of kilo-ohms to about $100 \text{ k}\Omega$. This resistance is also a function of temperature. The temperature coefficient of the resistance is usually specified in a thermopile's datasheet. As with any other parameter, minimum variation with temperature is desired.

The dominant noise source for a thermopile is its resistance. The noise spectral density of a resistor is calculated by:

$$\sqrt{4kRT}$$

Where k is the Boltzman constant and T is absolute temperature. The unit of noise spectral density is: $\text{V}/\sqrt{\text{Hz}}$

For the thermopile sensor, this noise is usually represented by V_{NOISE} where:

$$V_{\text{NOISE}} = \sqrt{4kR_{\text{TP}}T}$$

A typical value for this voltage noise is in the order of a few tens of $\text{nV}/\sqrt{\text{Hz}}$.

The Noise Equivalent Power, NEP, is often used to specify the minimum detectable signal level per square root bandwidth. A smaller NEP is desired, however NEP is dependent on the thermopile active area, A_D . For a thermopile

$$S = \frac{V_{\text{OUT}}}{P_{\text{IN}}} = \frac{V_{\text{OUT}}}{\vec{E} \cdot A_D}$$

and

$$\text{NEP} = \frac{V_{\text{NOISE}}}{S} = \frac{V_{\text{NOISE}} \cdot \vec{E} \cdot A_D}{V_{\text{OUT}}}$$

As shown above, the NEP of two thermopiles cannot be compared without considering the corresponding active areas.

A better way to compare thermopiles is to look at their specific detectivity, D^* . Specific detectivity includes both the device noise and its sensitivity. It is normalized with respect to the detector's active area and also noise bandwidth. D^* is given by:

$$D^* = \frac{S \times \sqrt{A_D}}{V_{\text{NOISE}}} = \frac{\sqrt{A_D}}{\text{NEP}}$$

The unit of D^* is $\text{cm}\sqrt{\text{Hz}}/\text{W}$. Typical values for specific detectivity range from 10^8 to $3 \times 10^8 \text{ cm}\sqrt{\text{Hz}}/\text{W}$.

After receiving radiation, the thermopile takes some time before it comes to thermal equilibrium. The time it takes for the sensor to achieve this equilibrium is called response time or time constant of the sensor. Clearly, lower time constants are very desirable.

Precision Amplifier

Since the output of thermopiles is usually very small and at most in the order of only a few millivolts, the first part of the signal conditioning path should involve amplification. In choosing an amplifier for this purpose, a few different sensor characteristics and the way they interface with the amplifier should be considered.

Sensor's Impedance and Op Amp's Input Bias Current:

The input bias current causes a voltage drop across the sensor and the amount of this voltage is equal to the sensor's impedance multiplied by the magnitude of bias current. The higher the sensor's input impedance, the more accentuated the effect of the amplifier's input bias current will be. For very high impedance sensors, it is imperative that op amps with very low input bias currents be used. Thermopiles have input impedances in the range of $100 \text{ k}\Omega$, so input bias current is not as critical as in some other applications.

Sensor's Output Voltage Range:

The output signal of the sensor is fed into the op amp where it will be amplified or otherwise conditioned, e.g. level shifted, buffered. It is important to pay attention to different parameters of this output signal.

The lowest expected level of the sensor's output is very important. It is necessary to compare this level with the different parameters contributing to the amplifier's total input noise. If the sensor's output level is in the same order of magnitude or smaller than the op amp's total input noise, then signal integrity at the op amp's output and the ADC's input will be compromised.

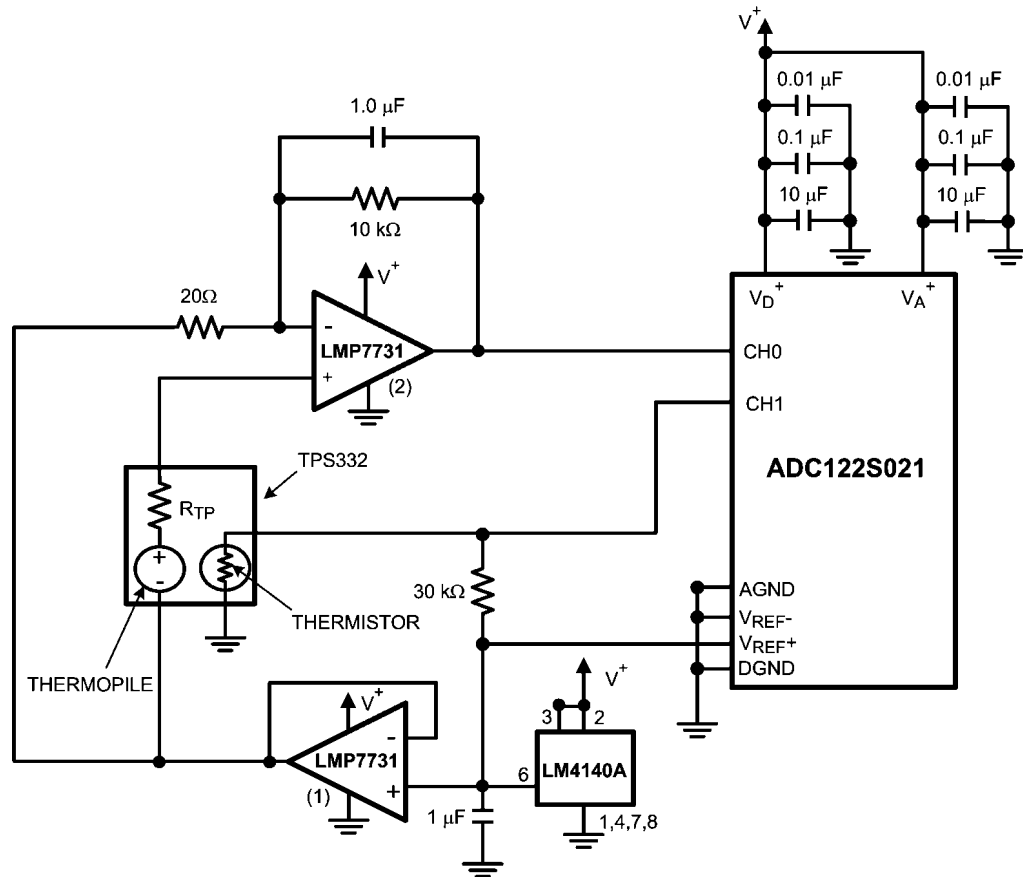

20175260

FIGURE 8. Thermopile Amplifier

Figure 8 shows the LMP7731 used as a thermopile amplifier. The LMP7731 is a great choice for use with thermopile sensors. The LMP7731 provides unprecedented accuracy and precision because of its very low input voltage noise and the very low $1/f$ corner frequency. The $1/f$ noise is one of the main sources of error in DC operating mode. Since thermopiles and most other sensors operate on DC signals, signal integrity at the DC level is very important. The LMP7731 also has very low offset voltage and offset voltage drift which greatly reduces the effects of input offset voltage of the amplifier on the thermopile signal. The thermopile used in this circuit is TPS332 from PerkinElmer Optoelectronics, PKI. This thermopile has an internal resistance, R_{TP} , of 75 k Ω . The output voltage of the thermopile is represented with a DC voltage source. The TPS332 has a thermistor integrated in the package. The thermistor is used to measure the ambient temperature of the thermopile at the time of measurement. The thermistor's resistance at room temperature is 30 k Ω . More information about this thermopile and other sensors from PKI can be found on <http://www.perkinelmer.com/>

The circuit in Figure 8 shows how the LMP7731 is connected to the thermopile. This circuit is comprised of two LMP7731 amplifiers, the LM4140A-2.5 which is a precision voltage reference, the ADC122S021 which is a 2 channel Analog to Digital converter, and the thermopile sensor. Note that the two amplifiers used in this circuit are numbered for ease of refer-

ence. The LMP7731 amplifiers are referred to as amplifier 1 and amplifier 2 per Figure 8.

In Figure 8 the LM4140A is providing a precision voltage reference of 2.5V. This reference voltage is applied to the thermistor via the 30 k Ω resistor. The thermistor's resistance is converted to a voltage using this set up. This voltage is fed into the ADC's channel one. The ADC uses this voltage and the thermistor's look up table to convert this voltage to temperature. The 2.5V reference is also fed into amplifier 1, which is configured as a buffer. This LMP7731 transfers the 2.5V signal to both inputs of amplifier 2. This means the 2.5V will show up on the output of amplifier 2. Having an output level that is mid-supply is important since the thermopile sensor has a bipolar output signal and this way the amplifier can accurately gain the thermopile voltage, whether its polarity is positive or negative. It is also important because the output signal of amplifier 2 is only positive. ADCs can only handle positive signals on their inputs. Amplifier 2 is used to gain and filter the thermopile signal. The low pass filter ensures that AC noise will not be gained up and as a result the output signal will be cleaner. The output of amplifier 2 is fed into the ADC's channel 0. The ADC uses the ambient temperature, which was calculated using the voltage on Channel 1 and the thermistor's look up table, along with the thermopiles' gained output voltage available on channel 0 and the thermopile's look up table to determine the object's temperature.

Physical Dimensions inches (millimeters) unless otherwise noted

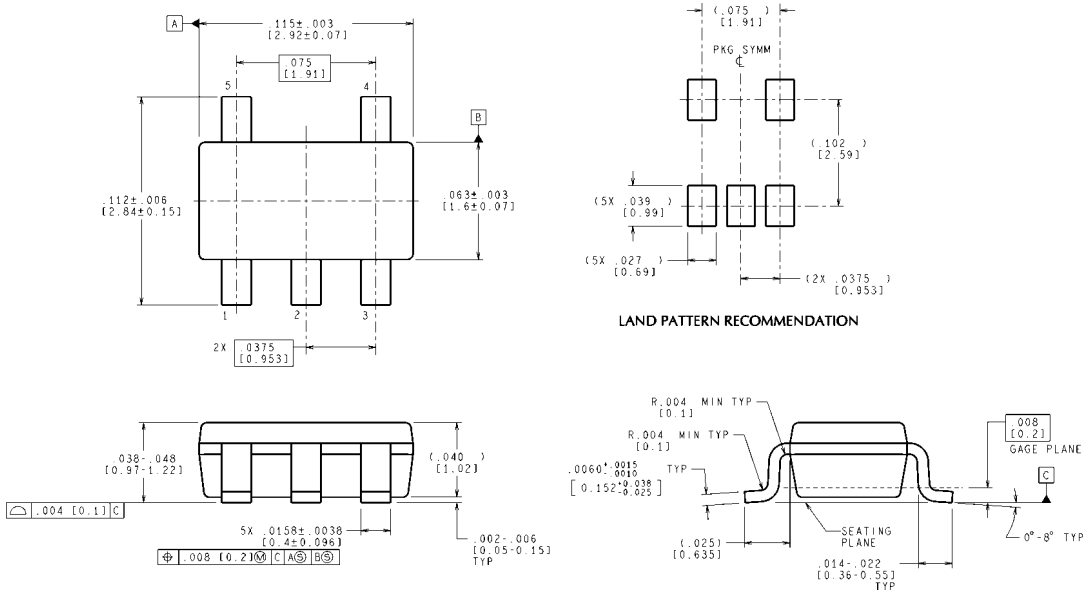

CONTROLLING DIMENSION IS INCH
 VALUES IN [] ARE MILLIMETERS
 DIMENSIONS IN () FOR REFERENCE ONLY

**5-Pin SOT23
 NS Package Number MF05A**

MF05A (Rev C)

Notes

THE CONTENTS OF THIS DOCUMENT ARE PROVIDED IN CONNECTION WITH NATIONAL SEMICONDUCTOR CORPORATION ("NATIONAL") PRODUCTS. NATIONAL MAKES NO REPRESENTATIONS OR WARRANTIES WITH RESPECT TO THE ACCURACY OR COMPLETENESS OF THE CONTENTS OF THIS PUBLICATION AND RESERVES THE RIGHT TO MAKE CHANGES TO SPECIFICATIONS AND PRODUCT DESCRIPTIONS AT ANY TIME WITHOUT NOTICE. NO LICENSE, WHETHER EXPRESS, IMPLIED, ARISING BY ESTOPPEL OR OTHERWISE, TO ANY INTELLECTUAL PROPERTY RIGHTS IS GRANTED BY THIS DOCUMENT.

TESTING AND OTHER QUALITY CONTROLS ARE USED TO THE EXTENT NATIONAL DEEMS NECESSARY TO SUPPORT NATIONAL'S PRODUCT WARRANTY. EXCEPT WHERE MANDATED BY GOVERNMENT REQUIREMENTS, TESTING OF ALL PARAMETERS OF EACH PRODUCT IS NOT NECESSARILY PERFORMED. NATIONAL ASSUMES NO LIABILITY FOR APPLICATIONS ASSISTANCE OR BUYER PRODUCT DESIGN. BUYERS ARE RESPONSIBLE FOR THEIR PRODUCTS AND APPLICATIONS USING NATIONAL COMPONENTS. PRIOR TO USING OR DISTRIBUTING ANY PRODUCTS THAT INCLUDE NATIONAL COMPONENTS, BUYERS SHOULD PROVIDE ADEQUATE DESIGN, TESTING AND OPERATING SAFEGUARDS.

EXCEPT AS PROVIDED IN NATIONAL'S TERMS AND CONDITIONS OF SALE FOR SUCH PRODUCTS, NATIONAL ASSUMES NO LIABILITY WHATSOEVER, AND NATIONAL DISCLAIMS ANY EXPRESS OR IMPLIED WARRANTY RELATING TO THE SALE AND/OR USE OF NATIONAL PRODUCTS INCLUDING LIABILITY OR WARRANTIES RELATING TO FITNESS FOR A PARTICULAR PURPOSE, MERCHANTABILITY, OR INFRINGEMENT OF ANY PATENT, COPYRIGHT OR OTHER INTELLECTUAL PROPERTY RIGHT.

LIFE SUPPORT POLICY

NATIONAL'S PRODUCTS ARE NOT AUTHORIZED FOR USE AS CRITICAL COMPONENTS IN LIFE SUPPORT DEVICES OR SYSTEMS WITHOUT THE EXPRESS PRIOR WRITTEN APPROVAL OF THE CHIEF EXECUTIVE OFFICER AND GENERAL COUNSEL OF NATIONAL SEMICONDUCTOR CORPORATION. As used herein:

Life support devices or systems are devices which (a) are intended for surgical implant into the body, or (b) support or sustain life and whose failure to perform when properly used in accordance with instructions for use provided in the labeling can be reasonably expected to result in a significant injury to the user. A critical component is any component in a life support device or system whose failure to perform can be reasonably expected to cause the failure of the life support device or system or to affect its safety or effectiveness.

National Semiconductor and the National Semiconductor logo are registered trademarks of National Semiconductor Corporation. All other brand or product names may be trademarks or registered trademarks of their respective holders.

Copyright© 2007 National Semiconductor Corporation

For the most current product information visit us at www.national.com



**National Semiconductor
Americas Customer
Support Center**
Email:
new.feedback@nsc.com
Tel: 1-800-272-9959

**National Semiconductor Europe
Customer Support Center**
Fax: +49 (0) 180-530-85-86
Email: europe.support@nsc.com
Deutsch Tel: +49 (0) 69 9508 6208
English Tel: +49 (0) 870 24 0 2171
Français Tel: +33 (0) 1 41 91 8790

**National Semiconductor Asia
Pacific Customer Support Center**
Email: ap.support@nsc.com

**National Semiconductor Japan
Customer Support Center**
Fax: 81-3-5639-7507
Email: jpn.feedback@nsc.com
Tel: 81-3-5639-7560