

LM9036

Ultra-Low Quiescent Current Voltage Regulator

General Description

The LM9036 ultra-low quiescent current regulator features low dropout voltage and low current in the standby mode. With less than 25µA Ground Pin current at a 0.1mA load, the LM9036 is ideally suited for automotive and other battery operated systems. The LM9036 retains all of the features that are common to low dropout regulators including a low dropout PNP pass device, short circuit protection, reverse battery protection, and thermal shutdown. The LM9036 has a 40V maximum operating voltage limit, a -40°C to +125°C operating temperature range, and ±5% output voltage tolerance over the entire output current, input voltage, and temperature range.

Features

- Ultra low Ground Pin current ($I_{GND} \leq 25\mu A$ for $I_{OUT} = 0.1mA$)
- Fixed 5V, 3.3V, 50mA output
- Output tolerance ±5% over line, load, and temperature
- Dropout voltage typically 200mV @ $I_{OUT} = 50mA$
- -45V reverse transient protection
- Internal short circuit current limit
- Internal thermal shutdown protection
- 40V operating voltage limit

Typical Application

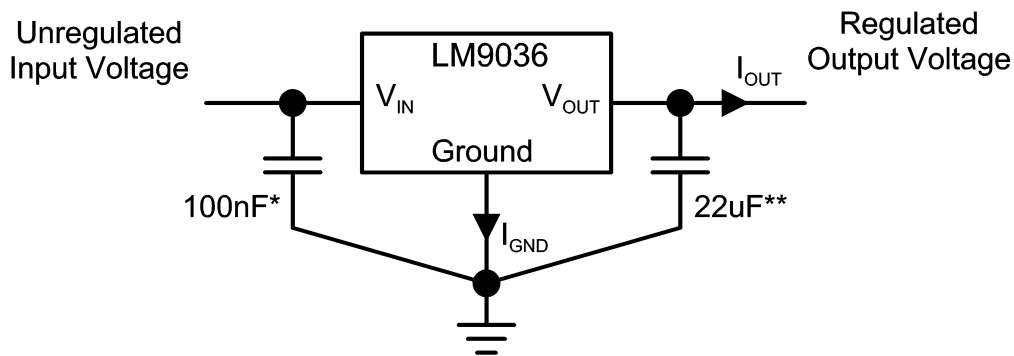

* Required if regulator is located more than 2" from power supply filter capacitor.

** Required for stability. Must be rated over intended operating temperature range. Effective series resistance (ESR) is critical, see Electrical Characteristics. Locate capacitor as close as possible to the regulator output and ground pins. Capacitance may be increased without bound.

20001101

Connection Diagrams

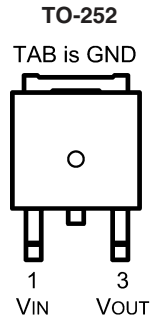

Top View
Order Number LM9036DT-5.0, LM9036DT-3.3
See NS Package Number TD03B

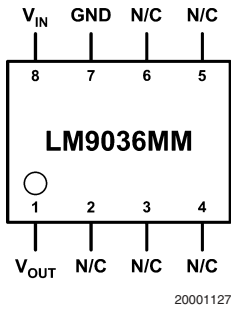

Top View
LM9036MM-3.3, LM9036MM-5.0
See NS Package Number MUA08A

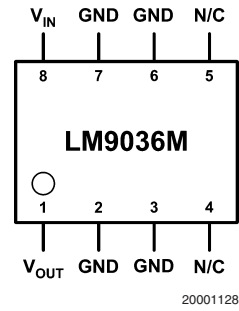

Top View
LM9036M-3.3, LM9036M-5.0
See NS Package Number M08A

Absolute Maximum Ratings (Note 1)

If Military/Aerospace specified devices are required, please contact the National Semiconductor Sales Office/Distributors for availability and specifications.

Input Voltage (Survival)	+55V, -45V
ESD Susceptibility (Note 2)	±1.9kV
Power Dissipation (Note 3)	Internally limited
Junction Temperature (T_{Jmax})	150°C
Storage Temperature Range	-65°C to +150°C
Lead Temperature (Soldering, 10 sec.)	260°C

Operating Ratings

Operating Temperature Range	-40°C to +125°C
Maximum Input Voltage (Operational)	40V
SO-8 (M08A) θ_{JA} (Note 7)	140°C/W
TO-252 (TD03B) θ_{JA} (Note 7)	125°C/W
TO-252 (TD03B) θ_{JA} (Note 8)	50°C/W
TO-252 (TD03B) θ_{JC} (Note 7)	11°C/W
MSO-8 (MUA08A) θ_{JA} (Note 7)	200°C/W

Electrical Characteristics - LM9036-5.0

$V_{IN} = 14V$, $I_{OUT} = 10\text{ mA}$, $T_J = 25^\circ\text{C}$, unless otherwise specified. **Boldface** limits apply over entire operating temperature range

Parameter	Conditions	Min (Note 5)	Typical (Note 4)	Max (Note 5)	Units
Output Voltage (V_{OUT})		4.80	5.00	5.20	V
	$5.5V \leq V_{IN} \leq 26V$, $0.1\text{mA} \leq I_{OUT} \leq 50\text{mA}$ (Note 6)	4.75	5.00	5.25	
Quiescent Current (I_{GND})	$I_{OUT} = 0.1\text{mA}$, $8V \leq V_{IN} \leq 24V$		20	25	μA
	$I_{OUT} = 1\text{mA}$, $8V \leq V_{IN} \leq 24V$		50	100	mA
	$I_{OUT} = 10\text{mA}$, $8V \leq V_{IN} \leq 24V$		0.3	0.5	
	$I_{OUT} = 50\text{mA}$, $8V \leq V_{IN} \leq 24V$		2.0	2.5	
Line Regulation (ΔV_{OUT})	$6V \leq V_{IN} \leq 40V$, $I_{OUT} = 1\text{mA}$		10	30	mV
Load Regulation (ΔV_{OUT})	$0.1\text{mA} \leq I_{OUT} \leq 5\text{mA}$		10	30	mV
	$5\text{mA} \leq I_{OUT} \leq 50\text{mA}$		10	30	mV
Dropout Voltage (ΔV_{OUT})	$I_{OUT} = 0.1\text{mA}$		0.05	0.10	V
	$I_{OUT} = 50\text{mA}$		0.20	0.40	V
Short Circuit Current (I_{SC})	$V_{OUT} = 0V$	65	120	250	mA
Ripple Rejection (PSRR)	$V_{ripple} = 1V_{rms}$, $F_{ripple} = 120\text{Hz}$	-40	-60		dB
Output Bypass Capacitance (C_{OUT})	$0.3\Omega \leq ESR \leq 8\Omega$ $0.1\text{mA} \leq I_{OUT} \leq 50\text{mA}$	10	22		μF

Electrical Characteristics - LM9036-3.3

$V_{IN} = 14V$, $I_{OUT} = 10\text{ mA}$, $T_J = 25^\circ\text{C}$, unless otherwise specified. **Boldface** limits apply over entire operating temperature range

Parameter	Conditions	Min (Note 5)	Typical (Note 4)	Max (Note 5)	Units
Output Voltage (V_{OUT})		3.168	3.30	3.432	V
	$5.5V \leq V_{IN} \leq 26V$, $0.1\text{mA} \leq I_{OUT} \leq 50\text{mA}$ (Note 6)	3.135	3.30	3.465	
Quiescent Current (I_{GND})	$I_{OUT} = 0.1\text{mA}$, $8V \leq V_{IN} \leq 24V$		20	25	μA
	$I_{OUT} = 1\text{mA}$, $8V \leq V_{IN} \leq 24V$		50	100	mA
	$I_{OUT} = 10\text{mA}$, $8V \leq V_{IN} \leq 24V$		0.3	0.5	
	$I_{OUT} = 50\text{mA}$, $8V \leq V_{IN} \leq 24V$		2.0	2.5	
Line Regulation (ΔV_{OUT})	$6V \leq V_{IN} \leq 40V$, $I_{OUT} = 1\text{mA}$		10	30	mV
Load Regulation (ΔV_{OUT})	$0.1\text{mA} \leq I_{OUT} \leq 5\text{mA}$		10	30	mV
	$5\text{mA} \leq I_{OUT} \leq 50\text{mA}$		10	30	mV
Dropout Voltage (ΔV_{OUT})	$I_{OUT} = 0.1\text{mA}$		0.05	0.10	V
	$I_{OUT} = 50\text{mA}$		0.20	0.40	V

Electrical Characteristics - LM9036-3.3 (Continued)

$V_{IN} = 14V$, $I_{OUT} = 10\text{ mA}$, $T_J = 25^\circ\text{C}$, unless otherwise specified. **Boldface** limits apply over entire operating temperature range

Parameter	Conditions	Min (Note 5)	Typical (Note 4)	Max (Note 5)	Units
Short Circuit Current (I_{SC})	$V_{OUT} = 0V$	65	120	250	mA
Ripple Rejection (PSRR)	$V_{ripple} = 1V_{rms}$, $F_{ripple} = 120\text{Hz}$	-40	-60		dB
Output Bypass Capacitance (C_{OUT})	$0.3\Omega \leq ESR \leq 8\Omega$ $0.1\text{mA} \leq I_{OUT} \leq 50\text{mA}$	22	33		μF

Note 1: Absolute Maximum Ratings indicate limits beyond which damage to the device may occur. DC and AC electrical specifications do not apply when operating the device beyond its specified operating ratings.

Note 2: Human body model, 100pF discharge through a 1.5k Ω resistor.

Note 3: The maximum power dissipation is a function of T_{Jmax} , θ_{JA} , and T_A . The maximum allowable power dissipation at any ambient temperature is $P_D = (T_{Jmax} - T_A)/\theta_{JA}$. If this dissipation is exceeded, the die temperature will rise above 150°C and the LM9036 will go into thermal shutdown.

Note 4: Typicals are at 25°C (unless otherwise specified) and represent the most likely parametric norm.

Note 5: Tested limits are guaranteed to National's AOQL (Average Outgoing Quality Level) and 100% tested.

Note 6: To ensure constant junction temperature, pulse testing is used.

Note 7: Worst case (Free Air) per EIA / JESD51-3.

Note 8: Typical θ_{JA} with 1 square inch of 2oz copper pad area directly under the ground tab.

Ordering Information

	TO-252	SOIC	Mini SOIC
3.30V	LM9036DT-3.3	LM9036M-3.3	LM9036MM-3.3
5.00V	LM9036DT-3.3	LM9036M-5.0	LM9036MM-5.0

Typical Performance Characteristics

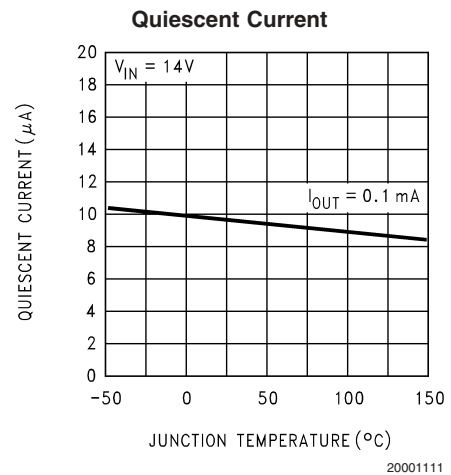
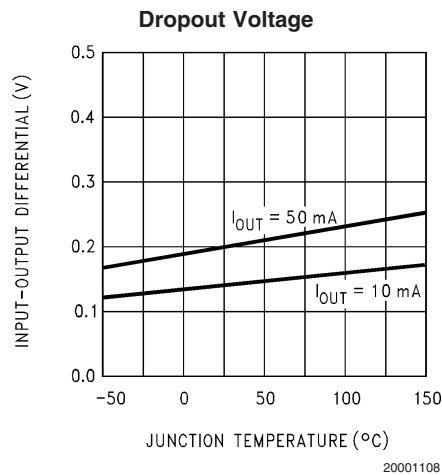

Typical Performance Characteristics (Continued)

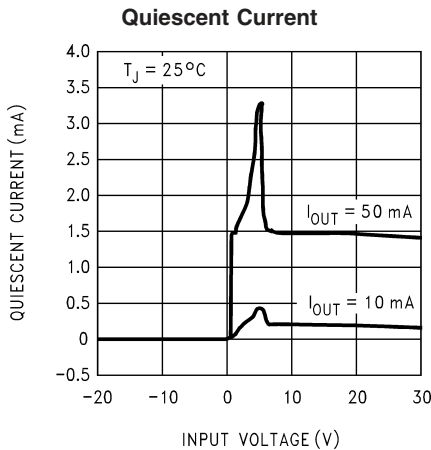

20001113

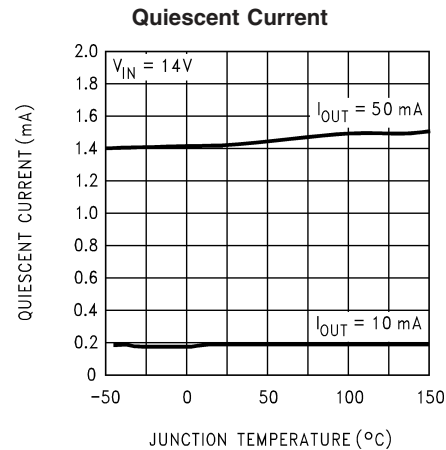

20001114

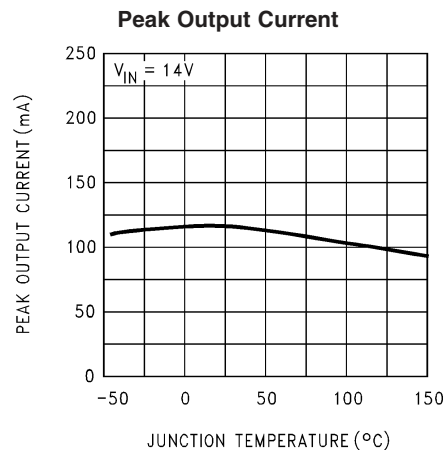

20001117

Applications Information

Unlike other PNP low dropout regulators, the LM9036 remains fully operational to 40V. Owing to power dissipation characteristics of the package, full output current cannot be guaranteed for all combinations of ambient temperature and input voltage.

The junction to ambient thermal resistance θ_{JA} rating has two distinct components: the junction to case thermal resistance rating θ_{JC} ; and the case to ambient thermal resistance rating θ_{CA} . The relationship is defined as: $\theta_{JA} = \theta_{JC} + \theta_{CA}$.

On the TO-252 package the ground tab is thermally connected to the backside of the die. Adding 1 square inch of 2 oz. copper pad area directly under the ground tab will improve the θ_{JA} rating to approximately 50°C/W.

While the LM9036 has an internally set thermal shutdown point of typically 150°C, this is intended as a safety feature only. Continuous operation near the thermal shutdown temperature should be avoided as it may have a negative effect on the life of the device.

Using the θ_{JA} for a LM9036DT mounted on a circuit board as defined at (Note 8), and using the formula for maximum allowable dissipation given in (Note 3) for an ambient temperature (T_A) of +85°C, we find that $P_{DMAX} = 1.3\text{W}$. Including the small contribution of the quiescent current I_Q to the total power dissipation, the maximum input voltage (while still delivering 50mA output current) is 29.5V. The LM9036DT will go into thermal shutdown when attempting to deliver the full output current of 50mA, with an ambient temperature of +85°C, and the input voltage is greater than 29.5V. Similarly, with an ambient temperature of 25°C the $P_{DMAX} = 2.5\text{W}$, and the LM9036DT can deliver the full output current of 50mA with an input voltage of up to 40V.

While the LM9036 maintains regulation to 55V, it will not withstand a short circuit above 40V because of safe operating area limitations in the internal PNP pass device. Above 55V the LM9036 will break down with catastrophic effects on the regulator and possibly the load as well. Do not use this device in a design where the input operating voltage may exceed 40V, or where transients are likely to exceed 55V.

Physical Dimensions inches (millimeters) unless otherwise noted

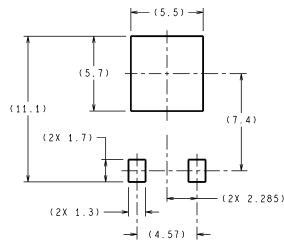

DIMENSIONS ARE IN MILLIMETERS

LAND PATTERN RECOMMENDATION

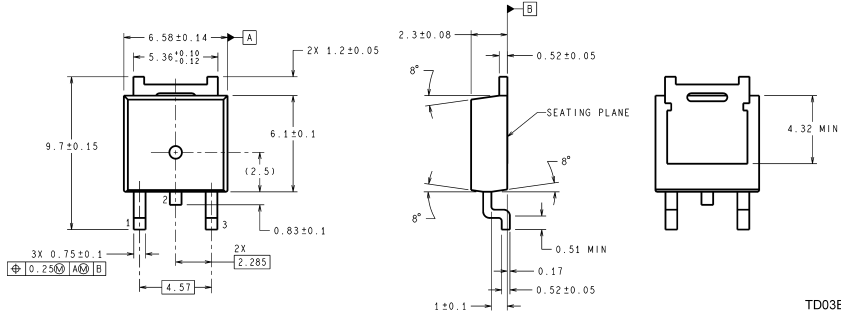

TD03B (Rev C)

TO-252 Package (DT)
NS Package Number TD03B

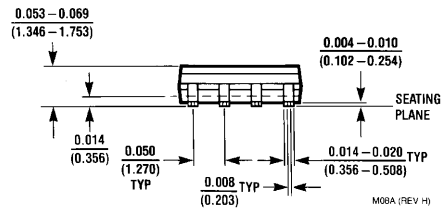
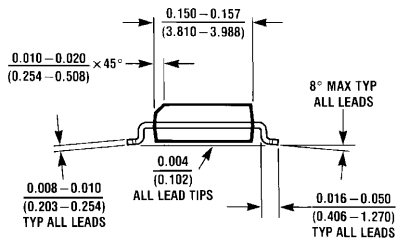
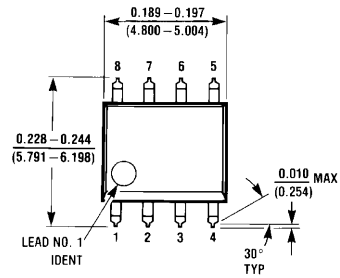

8 Lead Small Outline Molded Package (M)
NS Package Number M08A

Physical Dimensions inches (millimeters) unless otherwise noted (Continued)

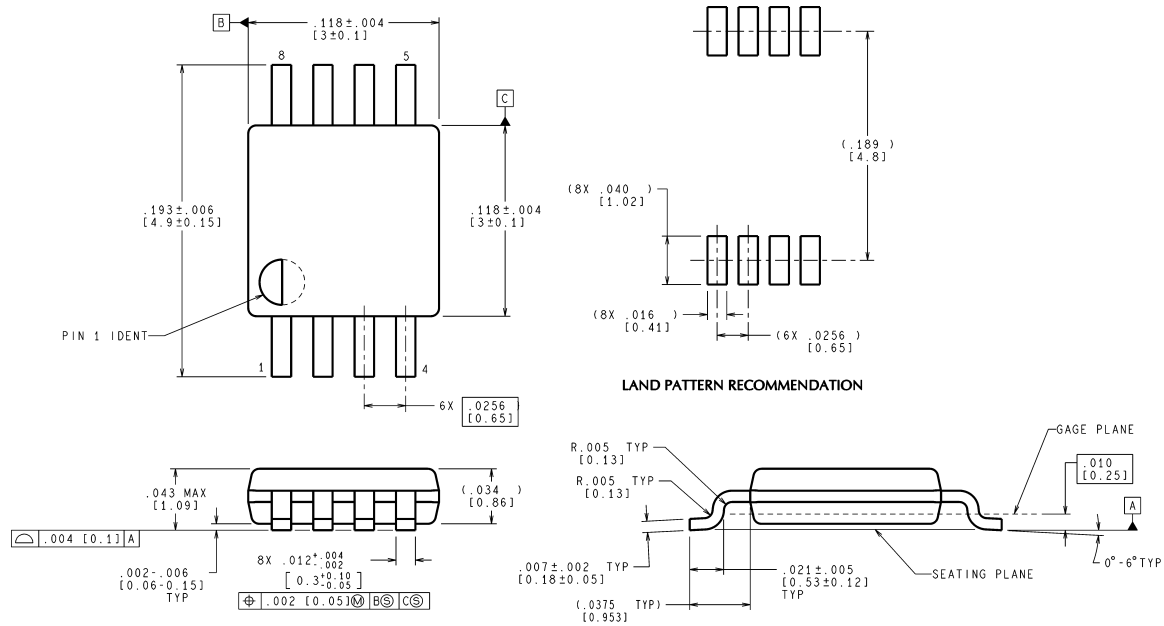

LAND PATTERN RECOMMENDATION

CONTROLLING DIMENSION IS INCH
VALUES IN [] ARE MILLIMETERS

MUA08A (Rev E)

**8 Lead Mini SOIC (MM)
NS Package Number MUA08A**

LIFE SUPPORT POLICY

NATIONAL'S PRODUCTS ARE NOT AUTHORIZED FOR USE AS CRITICAL COMPONENTS IN LIFE SUPPORT DEVICES OR SYSTEMS WITHOUT THE EXPRESS WRITTEN APPROVAL OF THE PRESIDENT AND GENERAL COUNSEL OF NATIONAL SEMICONDUCTOR CORPORATION. As used herein:

1. Life support devices or systems are devices or systems which, (a) are intended for surgical implant into the body, or (b) support or sustain life, and whose failure to perform when properly used in accordance with instructions for use provided in the labeling, can be reasonably expected to result in a significant injury to the user.
2. A critical component is any component of a life support device or system whose failure to perform can be reasonably expected to cause the failure of the life support device or system, or to affect its safety or effectiveness.

BANNED SUBSTANCE COMPLIANCE

National Semiconductor certifies that the products and packing materials meet the provisions of the Customer Products Stewardship Specification (CSP-9-111C2) and the Banned Substances and Materials of Interest Specification (CSP-9-111S2) and contain no "Banned Substances" as defined in CSP-9-111S2.

National Semiconductor
Americas Customer Support Center
Email: new.feedback@nsc.com
Tel: 1-800-272-9959

National Semiconductor
Europe Customer Support Center
Fax: +49 (0) 180-530 85 86
Email: europe.support@nsc.com
Deutsch Tel: +49 (0) 69 9508 6208
English Tel: +44 (0) 870 24 0 2171
Français Tel: +33 (0) 1 41 91 8790

National Semiconductor
Asia Pacific Customer Support Center
Email: ap.support@nsc.com

National Semiconductor
Japan Customer Support Center
Fax: 81-3-5639-7507
Email: jpn.feedback@nsc.com
Tel: 81-3-5639-7560

www.national.com

National does not assume any responsibility for use of any circuitry described, no circuit patent licenses are implied and National reserves the right at any time without notice to change said circuitry and specifications.