

# LM9071

## Low-Dropout System Voltage Regulator with Delayed Reset

### General Description

The LM9071 is a 5V, 250 mA low-dropout voltage regulator. The regulator features an active low delayed reset output flag which can be used to reset a microprocessor system on turn-ON and in the event that the regulator output falls out of regulation for any reason. An external capacitor programs a delay time interval before the reset output can return high.

Designed for automotive application the LM9071 contains a variety of protection features such as reverse battery, over-voltage shutdown, thermal shutdown, input transient protection and a wide operating temperature range.

Design techniques have been employed to allow the regulator to remain operational and not generate false reset signals when subjected to high levels of RF energy (300V/m from 2 MHz to 400 MHz).

### Features

- Automotive application reliability
- 3% output voltage tolerance
- Insensitive to radiated RFI
- Dropout voltage less than 800 mV with 250 mA output current
- Externally programmed reset delay interval
- Thermal shutdown
- Short circuit protection
- Reverse battery protection
- Wide operating temperature range  $-40^{\circ}\text{C}$  to  $+125^{\circ}\text{C}$
- TO-220 and TO-263 power surface mount power packages
- Pin for pin compatible with the LM2927, L4947 and TLE4260

### Typical Application and Connection Diagrams

(Top View)

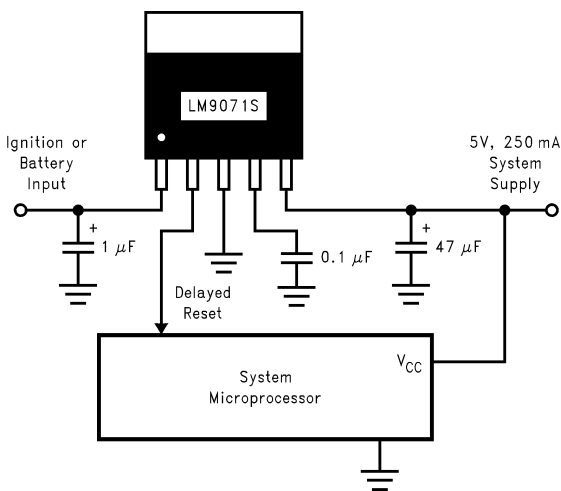

01283201

#### 5-Lead TO-220 Package

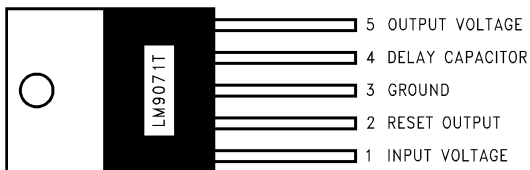

01283202

Order Number **LM9071T**  
See NS Package Number **T05A**

#### 5-Lead TO-220 Package

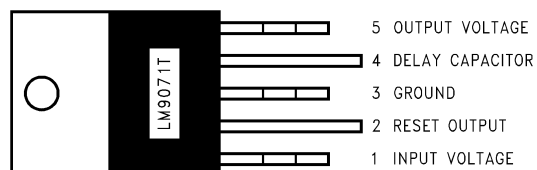

01283203

Order Number **LM9071T/Flow LB03**  
See NS Package Number **T05D**

#### 5-Lead TO-263 Surface Mount Package

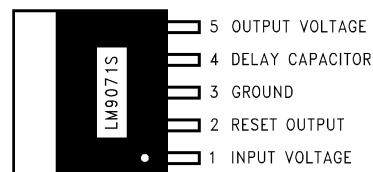

01283204

Tab and Backside metal on all packages internally connected to ground.

Order Number **LM9071S**  
See NS Package Number **TS5B**

**Absolute Maximum Ratings** (Note 1)

DC Input Voltage	-26V to +40V
Positive Input Transient (t<100 ms)	60V
Negative Input Transient (t<1 ms)	-50V
Reset Output Sink Current	5 mA
Power Dissipation	Internally Limited
Junction Temperature	150°C
ESD Susceptibility (Note 2)	12 kV, 2 kV
Lead Temperature (Soldering, 10 seconds)	260°C
Storage Temperature	-50°C to +150°C

**Operating Ratings** (Note 1)

Input Voltage	6V to 26V
Ambient Temperature	-40°C to +125°C
TO-220 Thermal Resistance, $\theta_{J-C}$	3°C/W
TO-220 Thermal Resistance, $\theta_{J-A}$	73°C/W
(Note 3)	
TO-263 Thermal Resistance, $\theta_{J-C}$	3°C/W
TO-263 Thermal Resistance, $\theta_{J-A}$	80°C/W
(Note 4)	

**Electrical Characteristics** (Note 5)

The following specifications apply for  $V_{CC}=6V$  to 26V,  $-40^{\circ}C \leq T_A \leq +125^{\circ}C$ , unless otherwise specified.  $C_{OUT}=47\mu F$  with an  $ESR < 3\Omega$ .  $C_{IN}=1\mu F$ .

Symbol	Parameter	Conditions	Min	Max	Units
<b>REGULATOR OUTPUT</b>					
$V_{OUT}$	Output Voltage	$5\text{ mA} \leq I_{OUT} \leq 250\text{ mA}$	4.85	5.15	V
$\Delta V_{OUT}$ Line	Line Regulation	$I_{OUT} = 5\text{ mA}$ , $9V \leq V_{IN} \leq 16.5V$ $I_{OUT} = 250\text{ mA}$		25 50	mV mV
$\Delta V_{OUT}$ Load	Load Regulation	$V_{IN} = 14.4V$ , $5\text{ mA} \leq I_{OUT} \leq 250\text{ mA}$		60	mV
$I_q$	Quiescent Current	$I_{OUT} = 5\text{ mA}$ $I_{OUT} = 250\text{ mA}$ , $V_{IN} \geq 8V$ $I_{OUT} = 5\text{ mA}$ , $V_{IN} = 5V$ $I_{OUT} = 250\text{ mA}$ , $V_{IN} = 6V$		4 25 10 50	mA mA mA mA
$V_{do}$	Dropout Voltage	$I_{OUT} = 5\text{ mA}$ $I_{OUT} = 250\text{ mA}$		300 800	mV mV
$I_{sc}$	Short Circuit Current	$R_L = 1\Omega$	0.35	1.5	A
PSRR	Ripple Rejection	$V_{IN} = (14V_{DC}) + (1V_{RMS} @ 120Hz)$ $I_{OUT} = 50\text{ mA}$	60		dB
OVthr	Overvoltage Shutdown Threshold		27		V
$V_O$ Transient	$V_{OUT}$ during Transients	$V_{IN}$ Peak $\leq 60V$ , $R_L = 100\Omega$ , $\tau = 100\text{ ms}$		7	V
$V_O$ Rev Batt	$V_{OUT}$ during Reverse Battery	$V_{IN} = -15V$	-0.8	0.0	V
<b>RESET OUTPUT</b>					
$V_{th}$	Threshold Voltage	$\Delta V_{OUT}$ Required to Generate a Reset Output $4.8V \leq V_{OUT} \leq 5.2V$	-300	-500	mV
$V_{low}$	Reset Output Low Voltage	$I_{sink} = 1.6\text{ mA}$ , $V_{OUT} > 3.2V$ $1.4V \leq V_{OUT} \leq 3.2V$		0.4 0.8	V V
$V_{high}$	Reset Output High Voltage		0.8 $V_{OUT}$		V
$t_{DELAY}$	Delay Time	$C_{DELAY} = 0.1\mu F$	7.6	35	ms
$I_{DELAY}$	Charging Current for $C_{DELAY}$		10	30	$\mu A$
$R_{pu}$	Internal Pull-up Resistance		12	80	$k\Omega$

**Note 1: Absolute Maximum Ratings** indicate limits beyond which damage to the device may occur. **Operating Ratings** indicate conditions for which the device is intended to be functional, but do not guarantee specific performance limits. For guaranteed specifications and conditions, see the **Electrical Characteristics**.

**Note 2:** All pins will survive an ESD impulse of  $\pm 2000V$  using the human body model of 100 pF discharged through a 1.5 k $\Omega$  resistor. In addition the input voltage pin will withstand ten pulses of  $\pm 12\text{ kV}$  from a 150 pF capacitor discharged through a 560 $\Omega$  resistor when bypassed with a 22 nF, 100V capacitor.

**Note 3:** Exceeding the Maximum Allowable power dissipation will cause excessive die temperature, and the device will go into thermal shutdown. The  $\theta_{J-A}$  value for the TO-220 package (still air, no additional heat sink) is 73°C/W. The effective  $\theta_{J-A}$  value of the TO-220 package can be reduced by using conventional heat sink methods.

**Note 4:** Exceeding the Maximum Allowable power dissipation will cause excessive die temperature, and the device will go into thermal shutdown. The  $\theta_{J-A}$  value for the TO-263 package (still air, no additional heat sink) is 80°C/W. The effective  $\theta_{J-A}$  value of the TO-263 package can be reduced by increasing the printed circuit board area that is connected (soldered) to the package tab. Using 1 ounce (1.4 mils thick) copper clad with no solder mask, an area of 0.5 square inches will reduce  $\theta_{J-A}$  to 50°C/W, an area of 1.0 square inches will reduce  $\theta_{J-A}$  to 37°C/W, and an area of 1.6 square inches will reduce  $\theta_{J-A}$  to 32°C/W. If the printed circuit board uses a solder mask, the copper clad area should be increased by at least 50% to maintain a similar  $\theta_{J-A}$  rating.

**Note 5:** Datasheet min/max specifications are guaranteed by design, test, and/or statistical analysis.

# Typical Performance Characteristics

( $T_A = 25^\circ\text{C}$  unless indicated otherwise)

**Turn ON Characteristics**

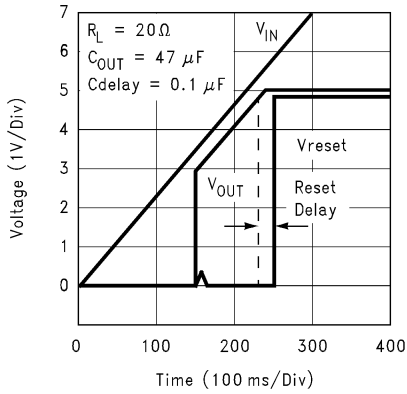

**Turn OFF Characteristics**

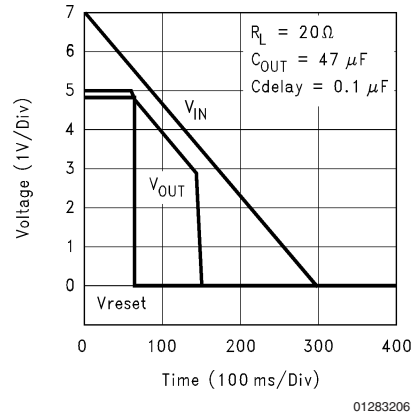

**Normalized Output Voltage vs Temperature**

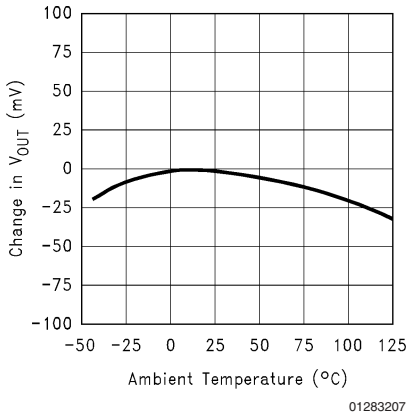

**Output Voltage at Input Voltage Extremes**

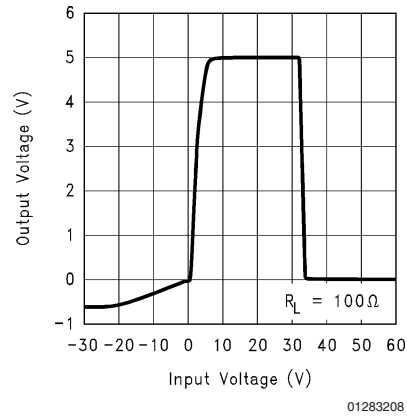

**Quiescent Current vs Input Voltage**

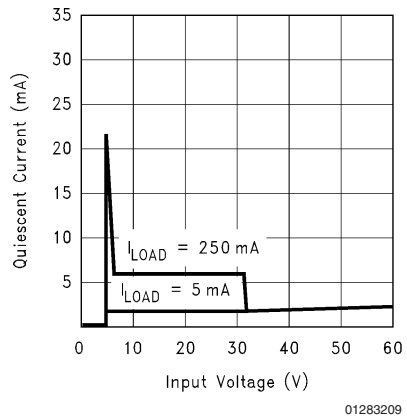

**Short Circuit Current vs Temperature**

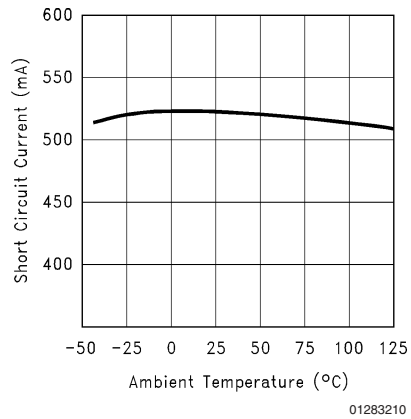

**Typical Performance Characteristics** ( $T_A = 25^\circ\text{C}$  unless indicated otherwise) (Continued)

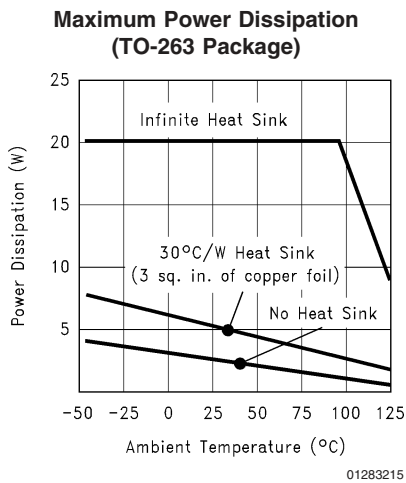
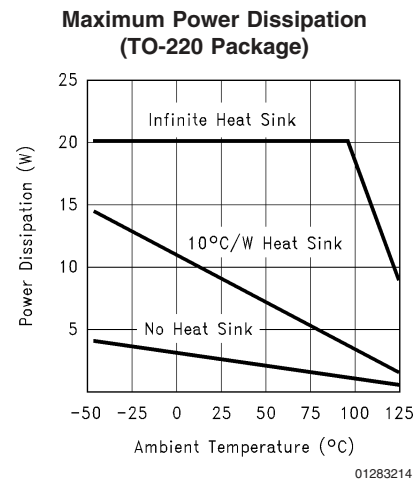
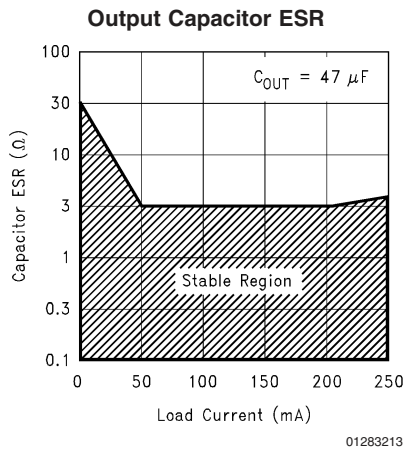
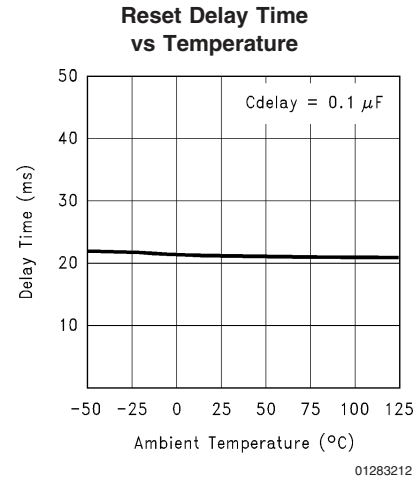
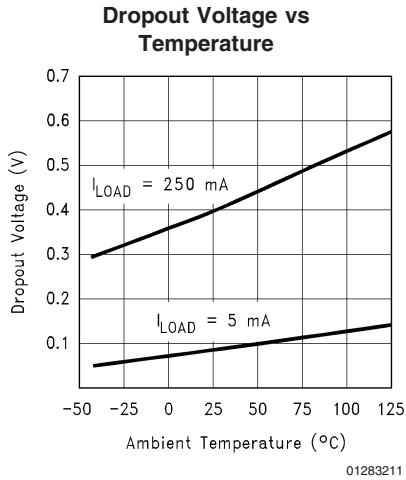

## Reset Operation and Protection Features

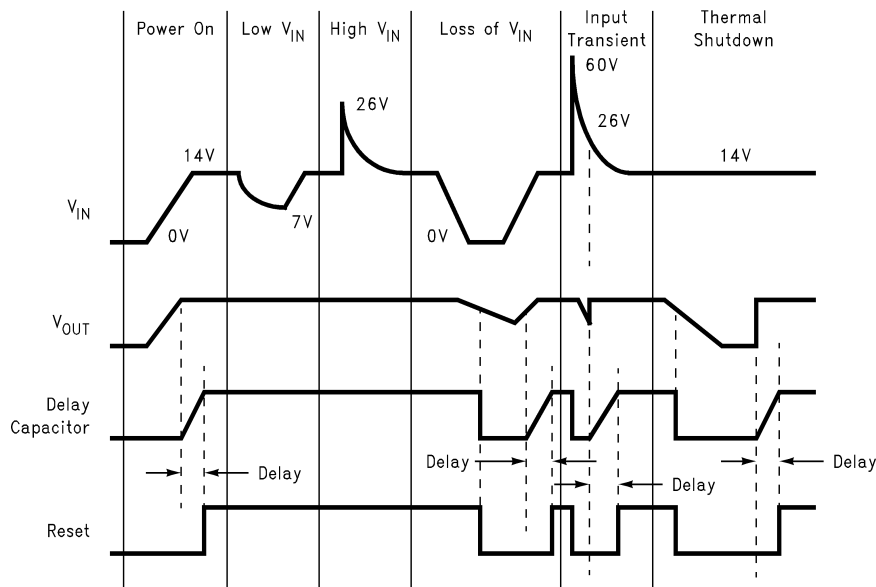

01283216

## Block Diagram

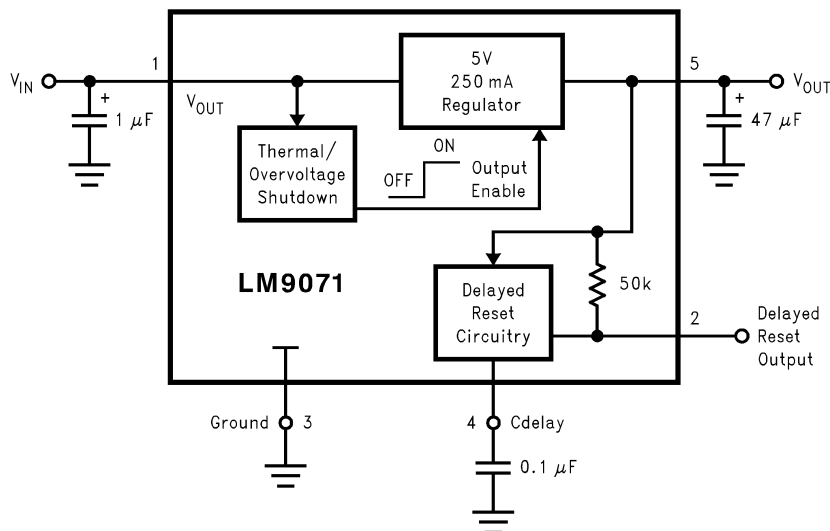

01283217

## Application Hints

The LM9071 voltage regulator has been optimized for use in microprocessor based automotive systems. Several unique design features have been incorporated to address many FMEA (Failure Mode Effects Analysis) concerns for fail-safe system performance.

### FAULT TOLERANT FEATURES

While not specifically guaranteed due to production testing limitations, the LM9071 has been tested and shown to continue to provide a regulated output and, not generate an erroneous system reset signal while subjected to high levels of RF electric field energy (up to 300 V/m signal strength over a 2 MHz to 400 MHz frequency range). This is very important in vehicle safety related applications where the

system must continue to operate normally. To maintain this immunity to RFI the output bypass capacitor is important (47 μF is recommended).

An output bypass capacitor of at least 10 μF is required for stability (47 μF is recommended). The ESR of this capacitor should be less than 3Ω. An input capacitor of 1 μF or larger is recommended to improve line transient and noise performance.

Conventional load dump protection is built in to withstand up to +60V and -50V transients. Protection against reverse polarity battery connections is also built in. With a reversed battery connection the output of the LM9071 will not go more negative than one diode drop below ground. This will prevent damage to any of the 5V load circuits.

## Application Hints (Continued)

### RESET FLAG

Excessive loading of the output to the point where the output voltage drops by 300 mV to 500 mV will signal a reset flag to the micro. This will warn of a  $V_{CC}$  supply that may produce unpredictable operation of the system. On power-up and recovery from a fault condition the delay capacitor is used to hold the micro in a reset condition for a programmable time interval to allow the system operating voltages and clock to stabilize before executing code. The delay time interval can be estimated by the following equation:

$$t_{\text{DELAY}} = \frac{3.8V \times C_{\text{DELAY}}}{20 \mu\text{A}}$$

### INPUT STABILITY

Low dropout voltage regulators which utilize a PNP power transistor usually exhibit a large increase in current when in dropout ( $V_{\text{IN}} < 5.5V$ ). This increase is caused by the saturation characteristics ( $\beta$  reduction) of the PNP transistor. To significantly minimize this increase in current the LM9071 detects when the PNP enters saturation and reduces the operating current.

This reduction in input current can create a stability problem in applications with higher load current ( $> 100 \text{ mA}$ ) where the input voltage is applied through a long length of wire, which in effect adds a significant amount of inductance in series with the input. The drop in input current may create a positive input voltage transient which may take the PNP out of saturation. If the input voltage is held constant at the threshold where the PNP is going in and out of saturation, an oscillation may be created.

This is only observed where a large series inductance is present in the input supply line and when the rise and fall time of the input supply is very slow. If the application and

removal of the input voltage changes at a rate greater than  $500 \text{ mV}/\mu\text{s}$  it will move through the dropout region of the regulator ( $V_{\text{IN}}$  of 3V to 5.5V) too quickly for an oscillation to be established.

### THERMAL MANAGEMENT

The LM9071 is packaged in both a TO-263 surface mount power package and a narrow lead-pitch TO-220 package. To obtain operation over the highest possible load current and input voltage ranges, care must be taken to control the operating temperature of the device. Thermal shutdown protection is built in, with a threshold above  $150^\circ\text{C}$ . Conventional heat-sinking techniques can be used with the TO-220 package. When applying the TO-263 package, on board heat-sinking is important to prevent premature thermal shutdown. More copper foil area under the tab of the device will directly improve the operating  $\theta_{\text{J-A}}$  of the TO-263 package, which will reduce the junction temperature of the device.

The  $\theta_{\text{J-A}}$  value for the TO-263 package (still air, no additional heat sink) is rated at  $80^\circ\text{C}/\text{W}$ . The effective  $\theta_{\text{J-A}}$  value of the TO-263 package can be reduced by increasing the printed circuit board area that is connected (soldered) to the package tab. Using 1 ounce (1.4 mils thick) copper clad with no solder mask, an area of 0.5 square inches will reduce  $\theta_{\text{J-A}}$  to  $50^\circ\text{C}/\text{W}$ , an area of 1.0 square inches will reduce  $\theta_{\text{J-A}}$  to  $37^\circ\text{C}/\text{W}$ , and an area of 1.6 square inches will reduce  $\theta_{\text{J-A}}$  to  $32^\circ\text{C}/\text{W}$ . If the printed circuit board uses a solder mask, the copper clad area under the solder mask should be increased by at least 50% to maintain a similar  $\theta_{\text{J-A}}$  rating.

The use of a double sided PC board with soldered filled vias between two planes of copper, as shown in Figure 1, will improve thermal performance while optimizing the PC board surface area required. Using the double sided PC board arrangement shown in Figure 1, with 1 ounce (1.4 mils thick) copper clad with no solder mask and solder filled vias, an area of 0.5 square inches on both sides will reduce  $\theta_{\text{J-A}}$  to  $43^\circ\text{C}/\text{W}$ .

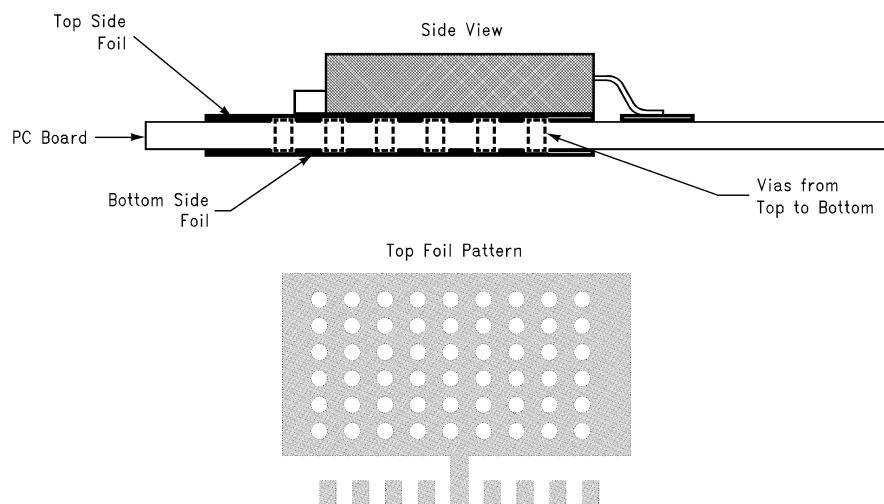

01283219

FIGURE 1. Typical TO-263 PC Board Heatsinking

# Physical Dimensions

inches (millimeters) unless otherwise noted

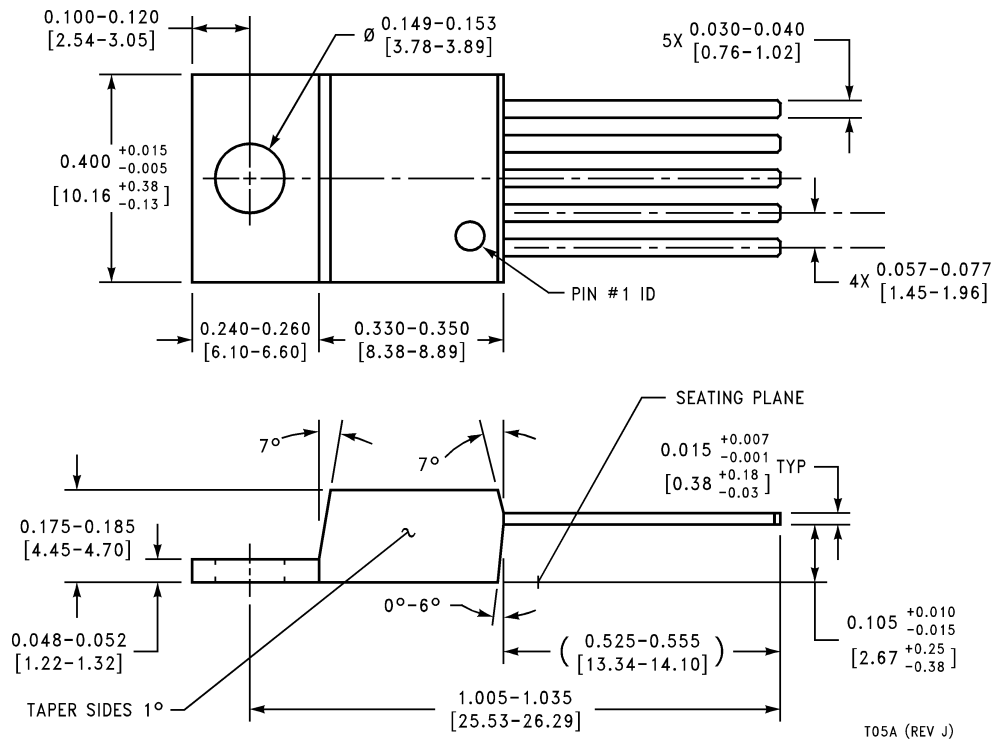

**5-Lead Molded TO-220**  
**Order Number LM9071T**  
**NS Package Number T05A**

# Physical Dimensions

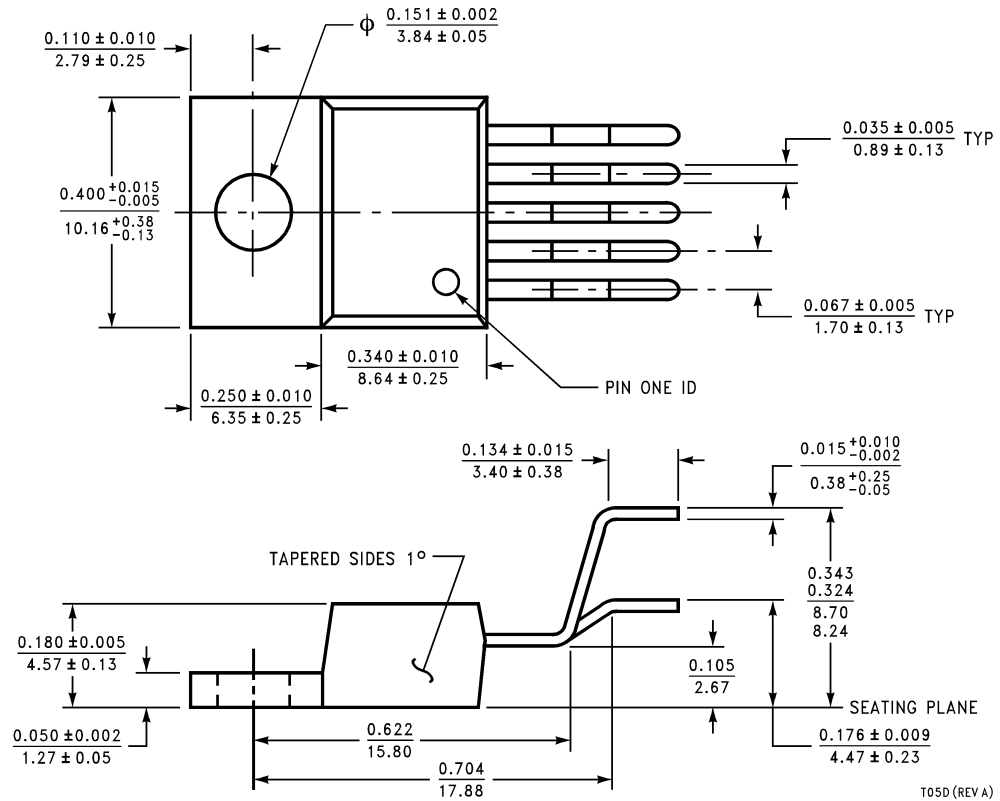
 inches (millimeters) unless otherwise noted (Continued)

**5-Lead Molded TO-220**  
**Order Number LM9071T/Flow LB03**  
**NS Package Number T05D**



**Physical Dimensions** inches (millimeters) unless otherwise noted (Continued)

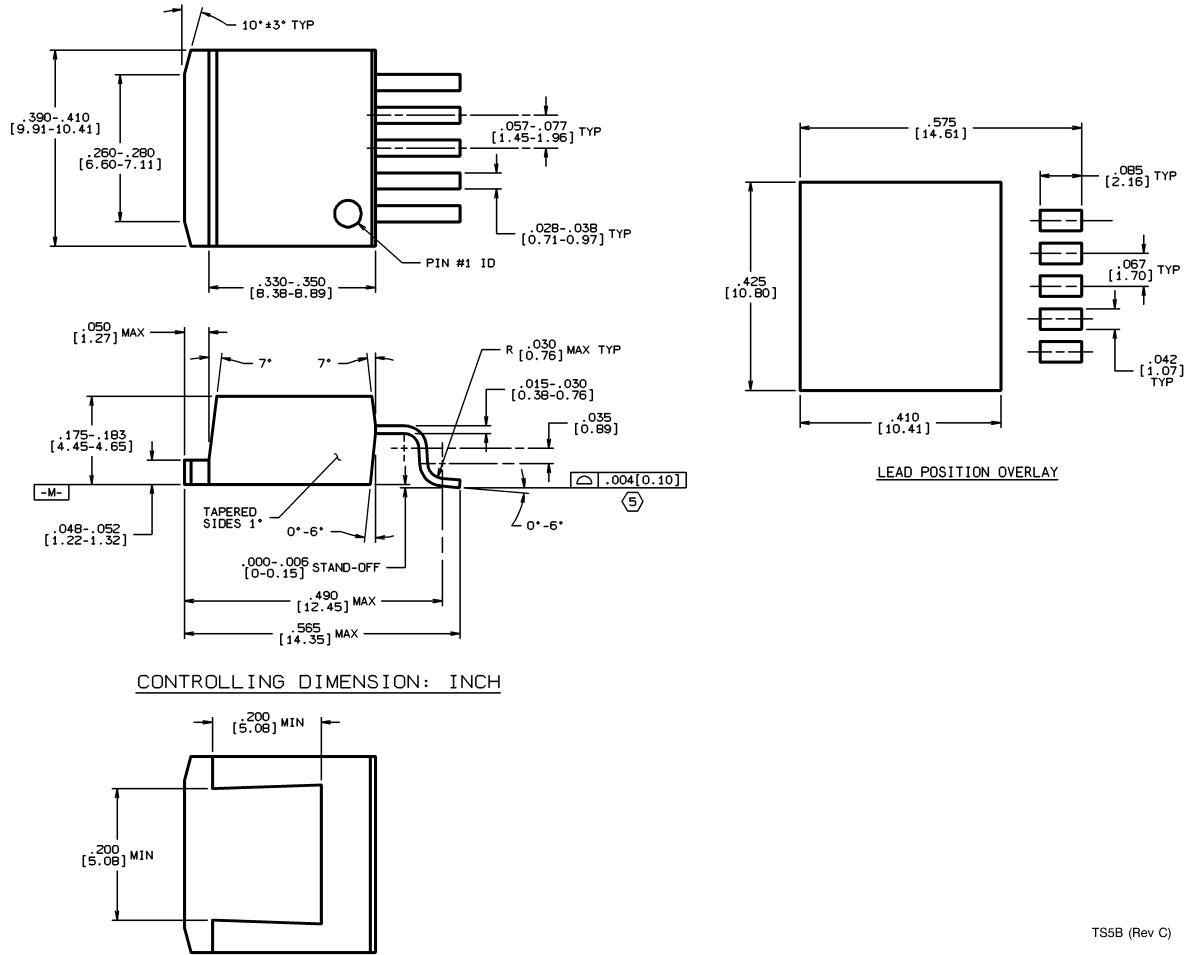

**5-Lead Molded TO-263**  
**Order Number LM9071S**  
**NS Package Number TS5B**

**LIFE SUPPORT POLICY**

NATIONAL'S PRODUCTS ARE NOT AUTHORIZED FOR USE AS CRITICAL COMPONENTS IN LIFE SUPPORT DEVICES OR SYSTEMS WITHOUT THE EXPRESS WRITTEN APPROVAL OF THE PRESIDENT AND GENERAL COUNSEL OF NATIONAL SEMICONDUCTOR CORPORATION. As used herein:

1. Life support devices or systems are devices or systems which, (a) are intended for surgical implant into the body, or (b) support or sustain life, and whose failure to perform when properly used in accordance with instructions for use provided in the labeling, can be reasonably expected to result in a significant injury to the user.
2. A critical component is any component of a life support device or system whose failure to perform can be reasonably expected to cause the failure of the life support device or system, or to affect its safety or effectiveness.

**BANNED SUBSTANCE COMPLIANCE**

National Semiconductor certifies that the products and packing materials meet the provisions of the Customer Products Stewardship Specification (CSP-9-111C2) and the Banned Substances and Materials of Interest Specification (CSP-9-111S2) and contain no "Banned Substances" as defined in CSP-9-111S2.



**National Semiconductor**  
**Americas Customer Support Center**  
 Email: [new.feedback@nsc.com](mailto:new.feedback@nsc.com)  
 Tel: 1-800-272-9959

**National Semiconductor**  
**Europe Customer Support Center**  
 Fax: +49 (0) 180-530 85 86  
 Email: [europa.support@nsc.com](mailto:europa.support@nsc.com)  
 Deutsch Tel: +49 (0) 69 9508 6208  
 English Tel: +44 (0) 870 24 0 2171  
 Français Tel: +33 (0) 1 41 91 8790

**National Semiconductor**  
**Asia Pacific Customer Support Center**  
 Email: [ap.support@nsc.com](mailto:ap.support@nsc.com)

**National Semiconductor**  
**Japan Customer Support Center**  
 Fax: 81-3-5639-7507  
 Email: [jpn.feedback@nsc.com](mailto:jpn.feedback@nsc.com)  
 Tel: 81-3-5639-7560

[www.national.com](http://www.national.com)

National does not assume any responsibility for use of any circuitry described, no circuit patent licenses are implied and National reserves the right at any time without notice to change said circuitry and specifications.