

# LM9076 150mA Ultra-Low Quiescent Current LDO Regulator with Delayed Reset Output

## General Description

The LM9076 is a  $\pm 3\%$ , 150 mA logic controlled voltage regulator. The regulator features an active low delayed reset output flag which can be used to reset a microprocessor system at turn-ON and in the event that the regulator output voltage falls below a minimum value. An external capacitor programs a delay time interval before the reset output pin can return high.

Designed for automotive and industrial applications, the LM9076 contains a variety of protection features such as thermal shutdown, input transient protection and a wide operating temperature range. The LM9076 uses an PNP pass transistor which allows low drop-out voltage operation.

## Features

- Available with 5.0V or 3.3V output voltage
- Ultra Low Ground Pin Current, 25  $\mu\text{A}$  typical for 100  $\mu\text{A}$  load
- $V_{\text{OUT}}$  initial accuracy of  $\pm 1.5\%$
- $V_{\text{OUT}}$  accurate to  $\pm 3\%$  over Load and Temperature Conditions
- Low Dropout Voltage, 200 mV typical with 150 mA load
- Low Off State Ground Pin current for LM9076BMA
- Delayed  $\overline{\text{RESET}}$  output pin for low  $V_{\text{OUT}}$  detection
- +70V/-50V Voltage Transients
- Operational  $V_{\text{IN}}$  up to +40V

## Typical Applications

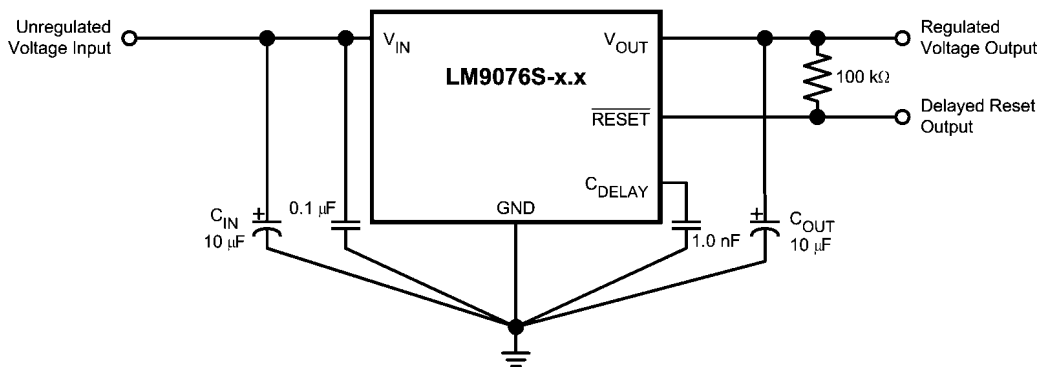

LM9076S-x.x in 5 lead TO-263 package

20083029

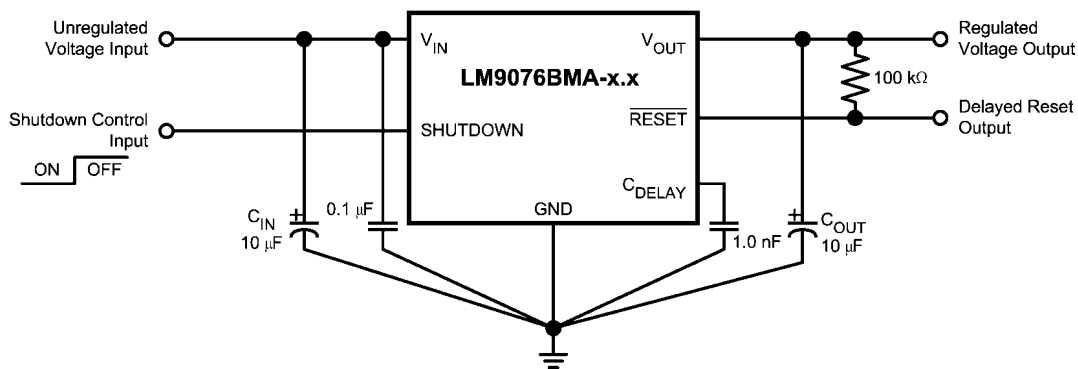

LM9076BMA-x.x in 8 lead SO package

20083030

## Connection Diagrams

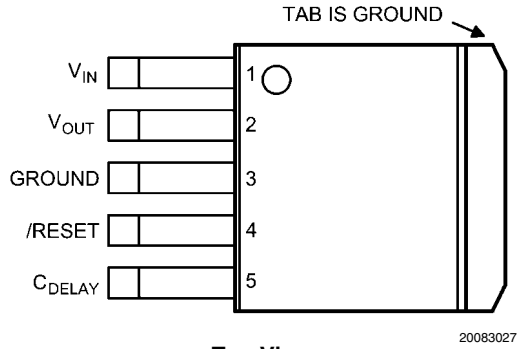

**Top View**  
Part Numbers LM9076S-3.3 and LM9076S-5.0  
See NS TO-263 Package Number TS5

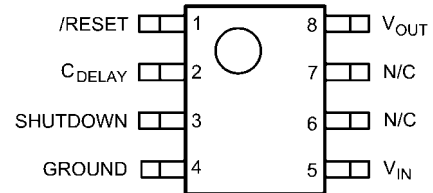

**Top View**  
Part Numbers LM9076BMA-3.3 and LM9076BMA-5.0  
See NS SOIC Package Number M08A

## Ordering Information

Output Voltage	Package Type	Order Number	Package Marking	Shipped As
3.3	TO-263-5	LM9076S-3.3	LM9076S-3.3	Rail of 45
		LM9076SX-3.3	LM9076S-3.3	Tape and Reel of 500
	SO-8	LM9076BMA-3.3	9076B MA3.3	Rail of 95
		LM9076BMAX-3.3	9076B MA3.3	Tape and Reel of 2500
5.0	TO-263-5	LM9076S-5.0	LM9076S-5.0	Rail of 45
		LM9076SX-5.0	LM9076S-5.0	Tape and Reel of 500
	SO-8	LM9076BMA-5.0	9076BMA5.0	Rail of 95
		LM9076BMAX-5.0	9076BMA5.0	Tape and Reel of 2500

**Absolute Maximum Ratings** (Note 1)

$V_{IN}(DC)$	-15V to +55V
$V_{IN}(+Transient) t < 10ms, Duty Cycle < 1\%$	+70V
$V_{IN}(-Transient) t < 1ms, Duty Cycle < 1\%$	-50V
SHUTDOWN Pin	-15V to +52V
RESET Pin	-0.3V to 20V
$C_{DELAY}$ Pin	-0.3V to $V_{OUT} + 0.3V$
Storage Temperature	-65°C to +150°C
Junction Temperature ( $T_J$ )	+175C
ESD, HBM, per AEC - Q100 - 002	+/-2 kV
ESD, MM, per AEC - Q100 - 003	+/-250V

**Operating Ratings** (Note 1)

$V_{IN}$ Pin	5.35V to 40V
$V_{SHUTDOWN}$ Pin	0V to 40V
Junction Temperature	-40°C < $T_J$ < +125°C
Thermal Resistance TS5B (Note 6)	
$\theta_{ja}$	75°C/W
$\theta_{jc}$	2.9°C/W
Thermal Resistance M08A (Note 6)	
$\theta_{ja}$	156°C/W
$\theta_{jc}$	59°C/W

**Electrical Characteristics for LM9076-3.3**

The following specifications apply for  $V_{IN} = 14V$ ;  $I_{LOAD} = 10\text{ mA}$ ;  $T_J = +25C$ ;  $C_{OUT} = 10\text{ }\mu\text{F}$ ,  $0.5\Omega < ESR < 4.0\Omega$ ; unless otherwise specified. **Bold values indicate  $-40^\circ\text{C} \leq T_J \leq +125^\circ\text{C}$ .** (Notes 5, 4) Minimum and Maximum limits are guaranteed through test, design or statistical correlation.

Symbol	Parameter	Conditions	Min	Typ	Max	Units
<b>LM9076-3.3 REGULATOR CHARACTERISTICS</b>						
$V_{OUT}$	Output Voltage		3.251	3.30	3.349	V
		$-20^\circ\text{C} \leq T_J \leq 85^\circ\text{C}$	3.234	3.30	3.366	V
		$1\text{ mA} \leq I_{LOAD} \leq 150\text{ mA}$	<b>3.201</b>	<b>3.30</b>	<b>3.399</b>	V
		$V_{IN} = 60V$ , $R_{LOAD} = 1\text{ k}\Omega$ , $t \leq 40ms$	2.970	3.30	3.630	V
	Output Voltage Off LM9076 BMA only	$V_{SHUTDOWN} \geq 2V$ , $R_{LOAD} = 1\text{ k}\Omega$	-	0	250	mV
Reverse Battery	$V_{IN} = -15V$ , $R_{LOAD} = 1\text{ k}\Omega$	-300	0	-	mV	
$\Delta V_{OUT}$	Line Regulation	$9.0V \leq V_{IN} \leq 16V$ , $I_{LOAD} = 10\text{ mA}$	-	4	25	mV
		$16V \leq V_{IN} \leq 40V$ , $I_{LOAD} = 10\text{ mA}$	-	17	35	mV
	Load Regulation	$1\text{ mA} \leq I_{LOAD} \leq 150\text{ mA}$	-	42	60	mV
$V_{DO}$	Dropout Voltage	$I_{LOAD} = 10\text{ mA}$	-	30	50	mV
		$I_{LOAD} = 50\text{ mA}$	-	80	-	mV
		$I_{LOAD} = 150\text{ mA}$	-	150	250	mV
$I_{GND}$	Ground Pin Current	$9V \leq V_{IN} \leq 16V$ , $I_{LOAD} = 100\text{ }\mu\text{A}$	-	25	45	$\mu\text{A}$
		$9V \leq V_{IN} \leq 40V$ , $I_{LOAD} = 10\text{ mA}$	-	125	160	$\mu\text{A}$
		$9V \leq V_{IN} \leq 40V$ , $I_{LOAD} = 50\text{ mA}$	-	0.6	-	mA
		$9V \leq V_{IN} \leq 16V$ , $I_{LOAD} = 150\text{ mA}$	-	3.6	4.5	mA
$I_{SC}$	$V_{OUT}$ Short Circuit Current	$V_{IN} = 14V$ , $R_{LOAD} = 1\Omega$	200	400	750	mA

Symbol	Parameter	Conditions	Min	Typ	Max	Units
PSRR	Ripple Rejection	$V_{IN} = (14V_{DC}) + (1V_{RMS})$ @ 120Hz $I_{LOAD} = 50 \text{ mA}$	50	60	-	dB
<b>RESET PIN CHARACTERISTICS</b>						
$V_{OR}$	Minimum $V_{IN}$ for valid $\overline{\text{RESET}}$ Status	(Note 3)	-	1.3	2.0	V
$V_{THR}$	$V_{OUT}$ Threshold for $\overline{\text{RESET}}$ Low	(Note 3)	0.83	0.89	0.94	X $V_{OUT}$ (Nom)
$V_{OH}$	$\overline{\text{RESET}}$ pin high voltage	External pull-up resistor to $V_{OUT} = 100 \text{ k}\Omega$	$V_{OUT} \times 0.90$	$V_{OUT} \times 0.99$	$V_{OUT}$	V
$V_{OL}$	$\overline{\text{RESET}}$ pin low voltage	$C_{DELAY} < 4.0V,$ $I_{SINK} = 250 \mu A$	-	0.2	0.3	V
<b><math>C_{DELAY}</math> PIN CHARACTERISTICS</b>						
$I_{DELAY}$	$C_{DELAY}$ Charging Current	$V_{IN} = 14V,$ $V_{DELAY} = 0V$	-0.70	-0.42	-0.25	$\mu A$
$V_{OL}$	$C_{DELAY}$ pin low voltage	$V_{OUT} < 4.0V,$ $I_{SINK} = I_{DELAY}$	-	0.100	-	V
$t_{DELAY}$	Reset Delay Time	$V_{IN} = 14V, C_{DELAY} =$ 0.001 $\mu F$ $V_{OUT}$ rising from 0V, $\Delta t$ from $V_{OUT} > V_{OR}$ to $\overline{\text{RESET}}$ pin HIGH	4.7	7.8	13.2	ms

## Electrical Characteristics for LM9076–5.0

The following specifications apply for  $V_{IN} = 14V$ ;  $V_{SHUTDOWN} = \text{Open}$ ;  $I_{LOAD} = 10 \text{ mA}$ ;  $T_J = +25^\circ\text{C}$ ;  $C_{OUT} = 10 \mu\text{F}$ ,  $0.5\Omega < \text{ESR} < 4.0\Omega$ ; unless otherwise specified. **Bold Values indicate  $-40^\circ\text{C} \leq T_J \leq 125^\circ\text{C}$ .** (Note 4), (Note 5) Minimum and Maximum limits are guaranteed through test, design, or statistical correlation.

Symbol	Parameter	Conditions	Min	Typ	Max	Units
<b>LM9076–5.0 REGULATOR CHARACTERISTICS</b>						
$V_{OUT}$	Output Voltage		4.925	5.00	5.075	V
		$-20^\circ\text{C} \leq T_J \leq 85^\circ\text{C}$	4.900	5.00	5.100	V
		$1 \text{ mA} \leq I_{LOAD} \leq 150 \text{ mA}$	<b>4.850</b>	<b>5.00</b>	<b>5.150</b>	V
		$V_{IN} = 60V$ , $R_{LOAD} = 1 \text{ k}\Omega$ , $t \leq 40\text{ms}$	4.500	5.00	5.500	V
	Output Voltage Off LM9076 BMA only	$V_{SHUTDOWN} \geq 2V$ , $R_{LOAD} = 1 \text{ k}\Omega$	–	0	250	mV
Reverse Battery	$V_{IN} = -15V$ , $R_{LOAD} = 1 \text{ k}\Omega$	–300	0	–	mV	
$\Delta V_{OUT}$	Line Regulation	$9.0V \leq V_{IN} \leq 16V$ , $I_{LOAD} = 10 \text{ mA}$	–	4	25	mV
		$16V \leq V_{IN} \leq 40V$ , $I_{LOAD} = 10 \text{ mA}$	–	17	35	mV
	Load Regulation	$1 \text{ mA} \leq I_{LOAD} \leq 150 \text{ mA}$	–	42	60	mV
$V_{DO}$	Dropout Voltage	$I_{LOAD} = 10 \text{ mA}$	–	30	50	mV
		$I_{LOAD} = 50 \text{ mA}$	–	80	–	mV
		$I_{LOAD} = 150 \text{ mA}$	–	150	250	mV
$I_{GND}$	Ground Pin Current	$9V \leq V_{IN} \leq 16V$ , $I_{LOAD} = 100 \mu\text{A}$	–	25	45	$\mu\text{A}$
		$9V \leq V_{IN} \leq 40V$ , $I_{LOAD} = 10 \text{ mA}$	–	125	160	$\mu\text{A}$
		$9V \leq V_{IN} \leq 40V$ , $I_{LOAD} = 50 \text{ mA}$	–	0.6	–	mA
		$9V \leq V_{IN} \leq 16V$ , $I_{LOAD} = 150 \text{ mA}$	–	3.6	4.5	mA
	Ground Pin Current in Shutdown Mode	$9V \leq V_{IN} \leq 40V$ , $V_{SHUTDOWN} = 2V$	–	15	25	$\mu\text{A}$
$I_{SC}$	$V_{OUT}$ Short Circuit Current	$V_{IN} = 14V$ , $R_{LOAD} = 1\Omega$	200	400	750	mA
PSRR	Ripple Rejection	$V_{IN} = (14V_{DC}) + (1V_{RMS} @ 120\text{Hz})$ $I_{LOAD} = 50 \text{ mA}$	50	60	–	dB
<b>RESET PIN CHARACTERISTICS</b>						
$V_{OR}$	Minimum $V_{IN}$ for valid RESET Status	(Note 3)	–	1.3	2.0	V
$V_{THR}$	$V_{OUT}$ Threshold for RESET Low	(Note 3)	0.83	0.89	0.94	$\times V_{OUT} (\text{Nom})$
$V_{OH}$	RESET pin high voltage	External pull-up resistor to $V_{OUT} = 100 \text{ k}\Omega$	$V_{OUT} \times 0.90$	$V_{OUT} \times 0.99$	$V_{OUT}$	V
$V_{OL}$	RESET pin low voltage	$C_{DELAY} < 4.0V$ , $I_{SINK} = 250 \mu\text{A}$	–	0.2	0.3	V
<b>C<sub>DELAY</sub> PIN CHARACTERISTICS</b>						

Symbol	Parameter	Conditions	Min	Typ	Max	Units
$I_{\text{DELAY}}$	$C_{\text{DELAY}}$ Charging Current	$V_{\text{IN}} = 14\text{V}$ , $V_{\text{DELAY}} = 0\text{V}$	-0.70	-0.42	-0.25	$\mu\text{A}$
$V_{\text{OL}}$	$C_{\text{DELAY}}$ pin low voltage	$V_{\text{OUT}} < 4.0\text{V}$ , $I_{\text{SINK}} = I_{\text{DELAY}}$	–	0.100	–	V
$t_{\text{DELAY}}$	Reset Delay Time	$V_{\text{IN}} = 14\text{V}$ , $C_{\text{DELAY}} = 0.001 \mu\text{F}$ $V_{\text{OUT}}$ rising from 0V, $\Delta t$ from $V_{\text{OUT}} > V_{\text{OR}}$ to RESET pin HIGH	7.1	11.9	20.0	ms

**SHUTDOWN CONTROL LOGIC — LM9076BMA-5.0 Only**

$V_{\text{IL(SD)}}$	SHUTDOWN Pin Low Threshold Voltage	$V_{\text{SHUTDOWN}}$ pin falling from 5.0V until $V_{\text{OUT}} > 4.5\text{V}$ ( $V_{\text{OUT}} = \text{On}$ )	1	1.5	–	V
$V_{\text{IH(SD)}}$	SHUTDOWN Pin High Threshold Voltage	$V_{\text{SHUTDOWN}}$ pin rising from 0V until $V_{\text{OUT}} < 0.5\text{V}$ ( $V_{\text{OUT}} = \text{Off}$ )	–	1.5	2	V
$I_{\text{IH(SD)}}$	SHUTDOWN Pin High Bias Current	$V_{\text{SHUTDOWN}} = 40\text{V}$	–	35	–	$\mu\text{A}$
		$V_{\text{SHUTDOWN}} = 5\text{V}$	–	15	35	$\mu\text{A}$
		$V_{\text{SHUTDOWN}} = 2\text{V}$	–	6	10	$\mu\text{A}$
$I_{\text{IL(SD)}}$	SHUTDOWN Pin Low Bias Current	$V_{\text{SHUTDOWN}} = 0\text{V}$	–	0	–	$\mu\text{A}$

**Note 1:** Absolute Maximum Ratings indicate the limits beyond which the device may cease to function, and/or damage to the device may occur.

**Note 2:** Operating Ratings indicate conditions for which the device is intended to be functional, but does not guarantee specific performance limits. For guaranteed specifications and conditions refer to the Electrical Characteristics

**Note 3:** Not Production tested, Guaranteed by Design. Minimum, Typical, and/or Maximum values are provided for informational purposes only.

**Note 4:** Pulse testing used maintain constant junction temperature ( $T_J$ ).

**Note 5:** The regulated output voltage specification is not guaranteed for the entire range of  $V_{\text{IN}}$  and output loads. Device operational range is limited by the maximum junction temperature ( $T_J$ ). The junction temperature is influenced by the ambient temperature ( $T_A$ ), package selection, input voltage ( $V_{\text{IN}}$ ), and the output load current. When operating with maximum load currents the input voltage and/or ambient temperature will be limited. When operating with maximum input voltage the load current and/or the ambient temperature will be limited.

**Note 6:** Worst case (FREE AIR) per EIA/JESD51–3.

# Typical Performance Characteristics

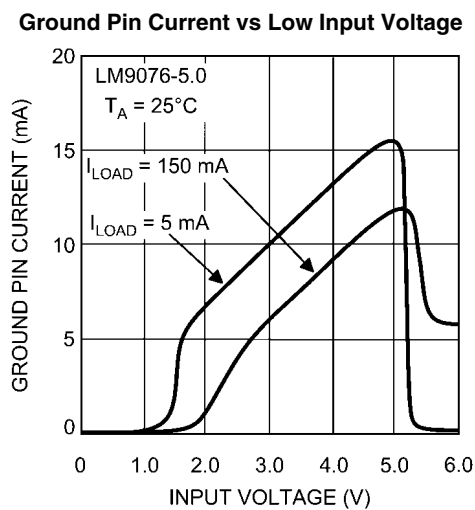
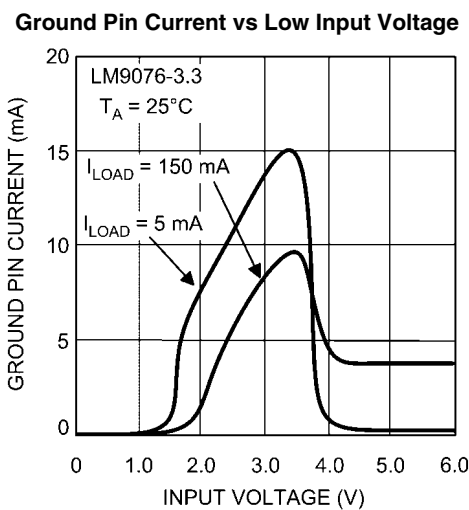
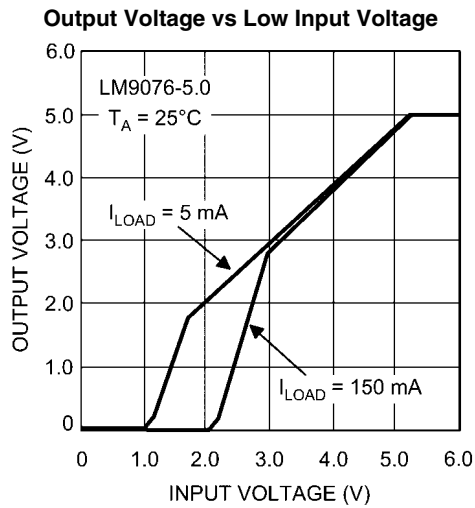
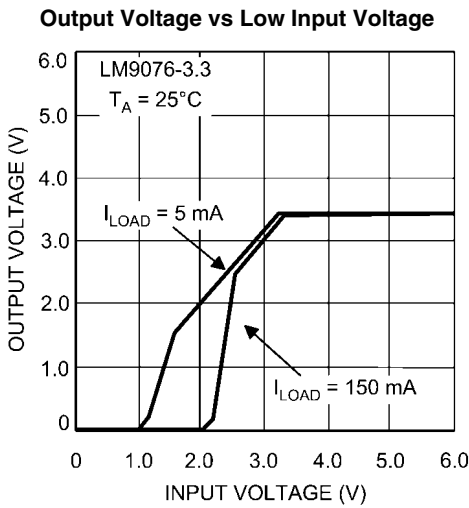
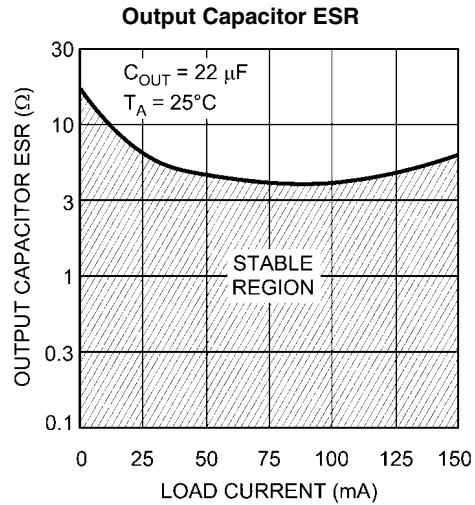
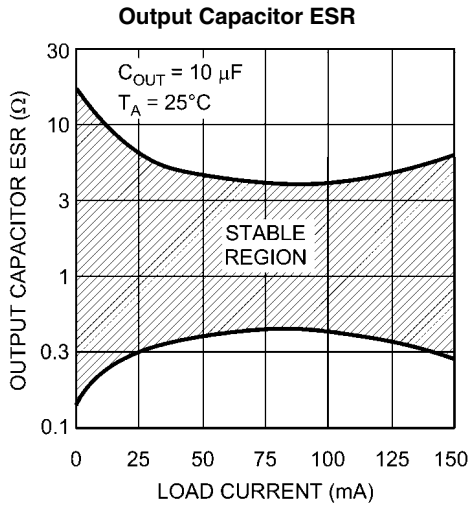

Ground Pin Current vs Load Current

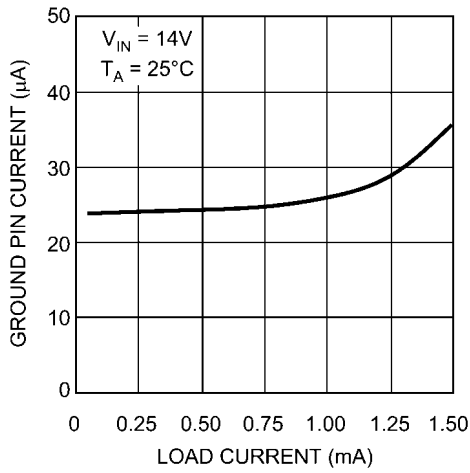

20083037

Ground Pin Current vs Load Current

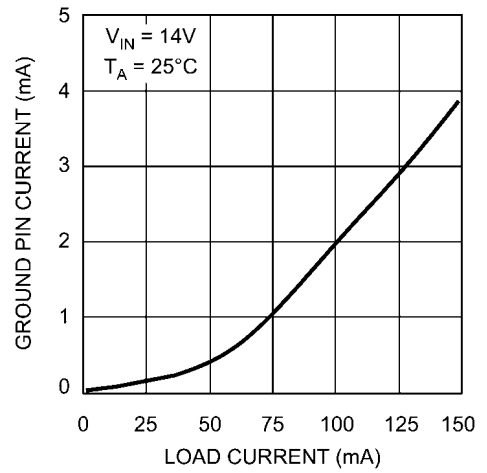

20083038

Output Voltage vs Input Voltage

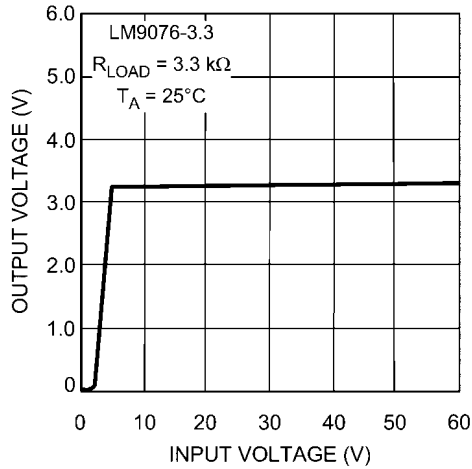

20083039

Output Voltage vs Input Voltage

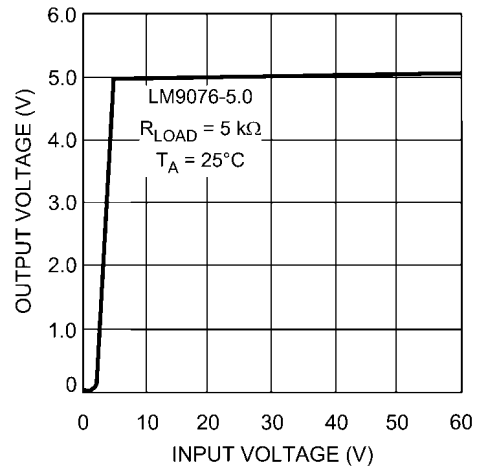

20083040

Output Voltage vs Junction Temperature

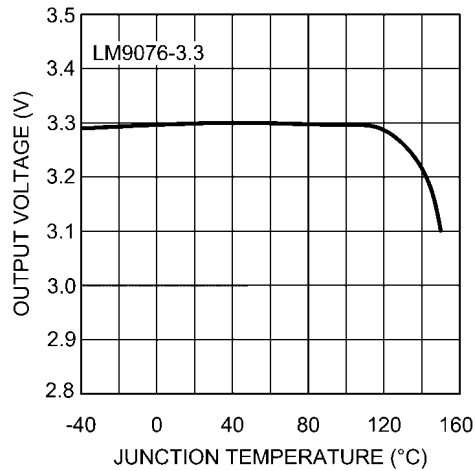

20083041

Output Voltage vs Junction Temperature

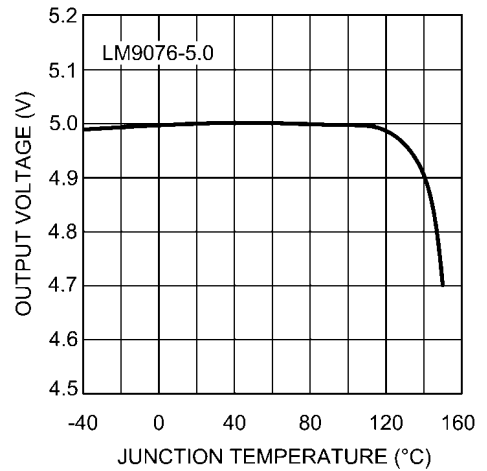

20083042



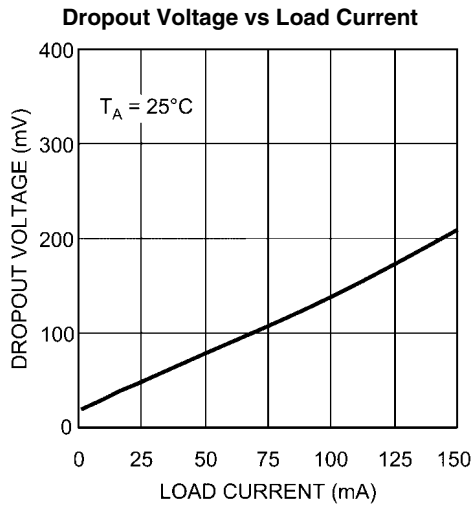

20083043

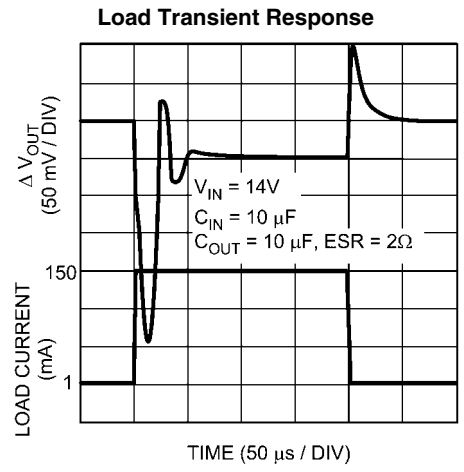

20083044

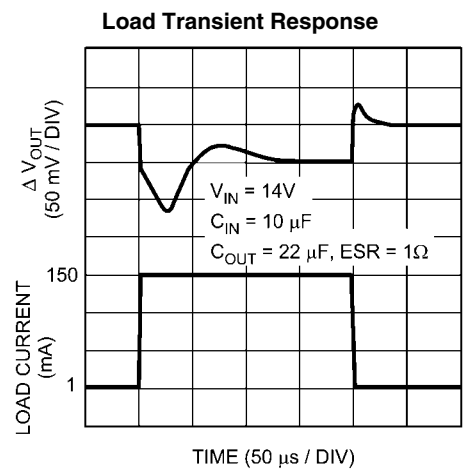

20083045

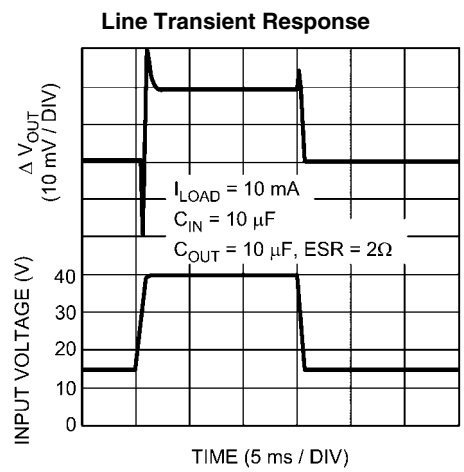

20083046

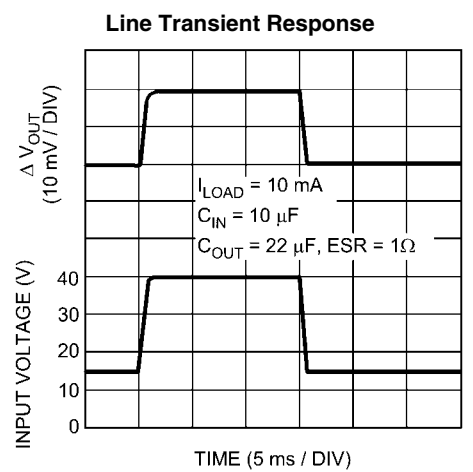

20083047

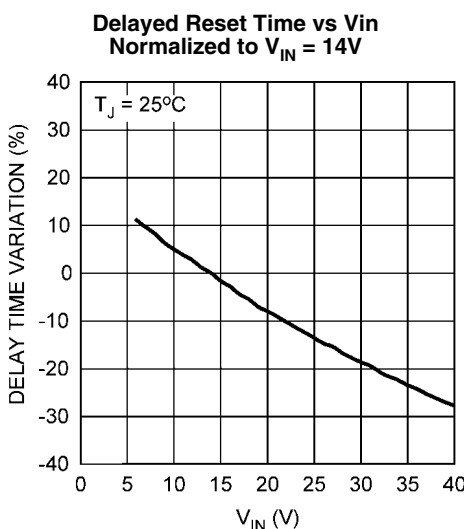

20083050

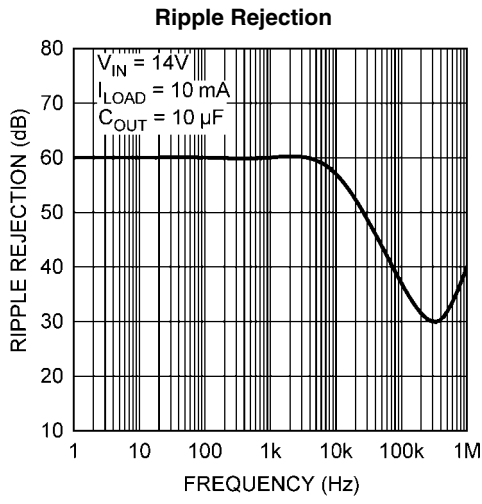

20083051

## Application Information

### REGULATOR BASICS

The LM9076 regulator is suitable for Automotive and Industrial applications where continuous connection to a battery supply is required (refer to the Typical Application circuit).

The pass element of the regulator is a PNP device which requires an output bypass capacitor for stability. The minimum bypass capacitance for the output is 10  $\mu\text{F}$  (refer to ESR limitations). A 22  $\mu\text{F}$ , or larger, output bypass capacitor is recommended for typical applications

### INPUT CAPACITOR

The LM9076 requires a low source impedance to maintain regulator stability because critical portions of the internal bias circuitry are connected to directly to  $V_{\text{IN}}$ . In general, a 10  $\mu\text{F}$  electrolytic capacitor, located within two inches of the LM9076, is adequate for a majority of applications. Additionally, and at a minimum, a 0.1  $\mu\text{F}$  ceramic capacitor should be located between the LM9076  $V_{\text{IN}}$  and Ground pin, and as close as is physically possible to the LM9076 itself.

### OUTPUT CAPACITOR

An output bypass capacitor is required for stability. This capacitance must be placed between the LM9076  $V_{\text{OUT}}$  pin and Ground pin, as close as is physically possible, using traces that are not part of the load current path.

The output capacitor must meet the requirements for minimum capacitance and also maintain the appropriate ESR value across the entire operating ambient temperature range. There is no limit to the maximum output capacitance as long as ESR is maintained.

The minimum bypass capacitance for the output is 10  $\mu\text{F}$  (refer to ESR limitations). A 22  $\mu\text{F}$ , or larger, output bypass capacitor is recommended for typical applications.

Solid tantalums capacitors are recommended as they generally maintain capacitance and ESR ratings over a wide temperature range. Ceramic capacitor types XR7 and XR5 may be used if a series resistor is added to simulate the minimum ESR requirement. See *Figure 1*.

Aluminum electrolytic capacitors are not recommended as they are subject to wide changes in capacitance and ESR across temperature.

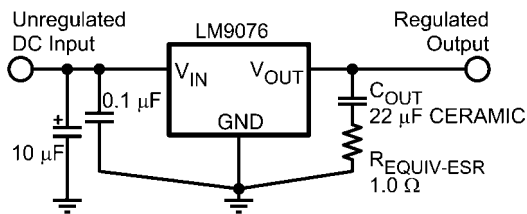

20083048

FIGURE 1. Using Low ESR Capacitors

### DELAY CAPACITOR

The capacitor on the Delay pin must be a low leakage type since the charge current is minimal (420 nA typical) and the pin must fully charge to  $V_{\text{OUT}}$ . Ceramic, Mylar, and polystyrene capacitor types are generally recommended, although changes in capacitance values across temperature changes will have some effect on the delay timing.

Any leakage of the  $I_{\text{DELAY}}$  current, be it through the delay capacitor or any other path, will extend the delay time, possibly to the point that the Reset pin output does not go high.

### SHUTDOWN PIN - LM9076BMA ONLY

The basic On/Off control of the regulator is accomplished with the SHUTDOWN pin. By pulling the SHUTDOWN pin high the regulator output is switched Off. When the regulator is switched Off the load on the battery will be primarily due to the SHUTDOWN pin current.

When the SHUTDOWN pin is low, or left open, the regulator is switched On. When an unregulated supply, such as  $V_{\text{BATTERY}}$ , is used to pull the SHUTDOWN pin high a series resistor in the range of 10K $\Omega$  to 50K $\Omega$  is recommended to provide reverse voltage transient protection of the SHUTDOWN pin. Adding a small capacitor (0.001 $\mu\text{F}$  typical) from the SHUTDOWN pin to Ground will add noise immunity to prevent accidental turn on due to noise on the supply line.

### RESET FLAG

The  $\overline{\text{RESET}}$  pin is an open collector output which requires an external pull-up resistor to develop the reset signal. The external pull-up resistor should be in the range of 10 k $\Omega$  to 200 k $\Omega$ .

At  $V_{\text{IN}}$  values of less than typically 2V the  $\overline{\text{RESET}}$  pin voltage will be high. For  $V_{\text{IN}}$  values between typically 2V and approximately  $V_{\text{OUT}} + V_{\text{BE}}$  the  $\overline{\text{RESET}}$  pin voltage will be low. For  $V_{\text{IN}}$  values greater than approximately  $V_{\text{OUT}} + V_{\text{BE}}$  the  $\overline{\text{RESET}}$  pin voltage will be dependent on the status of the  $V_{\text{OUT}}$  pin voltage and the Delayed Reset circuitry. The value of  $V_{\text{BE}}$  is typically 600 mV at 25 $^{\circ}\text{C}$  and will decrease approximately 2 mV for every 1 $^{\circ}\text{C}$  increase in the junction temperature. During normal operation the  $\overline{\text{RESET}}$  pin voltage will be high.

Any load condition that causes the  $V_{\text{OUT}}$  pin voltage to drop below typically 89% of normal will activate the Delayed Reset circuit and the  $\overline{\text{RESET}}$  pin will go low for the duration of the delay time.

Any line condition that causes  $V_{\text{IN}}$  pin voltage to drop below typically  $V_{\text{OUT}} + V_{\text{BE}}$  will cause the  $\overline{\text{RESET}}$  pin to go low without activating the Delayed Reset circuitry.

Excessive thermal dissipation will raise the junction temperature and could activate the Thermal Shutdown circuitry which, in turn, will cause the  $\overline{\text{RESET}}$  pin to go low.

For the LM9076BMA devices, pulling the SHUTDOWN pin high will turn off the output which, in turn, will cause the  $\overline{\text{RESET}}$  pin to go low once the  $V_{\text{OUT}}$  voltage has decayed to a value that is less than typically 89% of normal. See *Figure 2*.

### RESET DELAY TIME

When the regulator output is switched On, or after recovery from brief  $V_{\text{OUT}}$  fault condition, the  $\overline{\text{RESET}}$  flag can be programmed to remain low for an additional delay time. This will give time for any system reference voltages, clock signals, etc., to stabilize before the micro-controller resumes normal operation.

This delay time is controlled by the capacitor value on the  $C_{\text{DELAY}}$  pin. During normal operation the  $C_{\text{DELAY}}$  capacitor is charged to near  $V_{\text{OUT}}$ . When a  $V_{\text{OUT}}$  fault causes the  $\overline{\text{RESET}}$  pin to go low, the  $C_{\text{DELAY}}$  capacitor is quickly discharged to ground. When the  $V_{\text{OUT}}$  fault is removed, and  $V_{\text{OUT}}$  returns to the normal operating value, the  $C_{\text{DELAY}}$  capacitor begins charging at a typical constant 0.420  $\mu\text{A}$  rate. When the voltage on the  $C_{\text{DELAY}}$  capacitor reaches the same potential as the  $V_{\text{OUT}}$  pin the  $\overline{\text{RESET}}$  pin will be allowed to return high.

The typical  $\overline{\text{RESET}}$  delay time can be calculated with the following formula:

$$t_{\text{DELAY}} = V_{\text{OUT}} \times (C_{\text{DELAY}} / I_{\text{DELAY}})$$

For the LM9076–3.3 with a  $C_{\text{DELAY}}$  value of 0.001  $\mu\text{F}$  and a  $I_{\text{DELAY}}$  value of 0.420  $\mu\text{A}$  the typical  $\overline{\text{RESET}}$  delay time is:

$$t_{\text{DELAY}} = 3.3\text{V} \times (0.001 \mu\text{F} / 0.420 \mu\text{A}) = 7.8 \text{ ms}$$

For the LM9076–5.0 with a  $C_{\text{DELAY}}$  value of 0.001  $\mu\text{F}$  and a  $I_{\text{DELAY}}$  value of 0.420  $\mu\text{A}$  the typical  $\overline{\text{RESET}}$  delay time is:

$$t_{\text{DELAY}} = 5.0\text{V} \times (0.001 \mu\text{F} / 0.420 \mu\text{A}) = 11.9 \text{ ms}$$

### THERMAL PROTECTION

Device operational range is limited by the maximum junction temperature ( $T_J$ ). The junction temperature is influenced by the ambient temperature ( $T_A$ ), package selection, input volt-

age ( $V_{\text{IN}}$ ), and the output load current. When operating with maximum load currents the input voltage and/or ambient temperature will be limited. When operating with maximum input voltage the load current and/or the ambient temperature will be limited.

Even though the LM9076 is equipped with circuitry to protect itself from excessive thermal dissipation, it is not recommended that the LM9076 be operated at, or near, the maximum recommended die junction temperature ( $T_J$ ) as this may impair long term device reliability.

The thermal protection circuitry monitors the temperature at the die level. When the die temperature exceeds typically 160°C the voltage regulator output will be switched off.

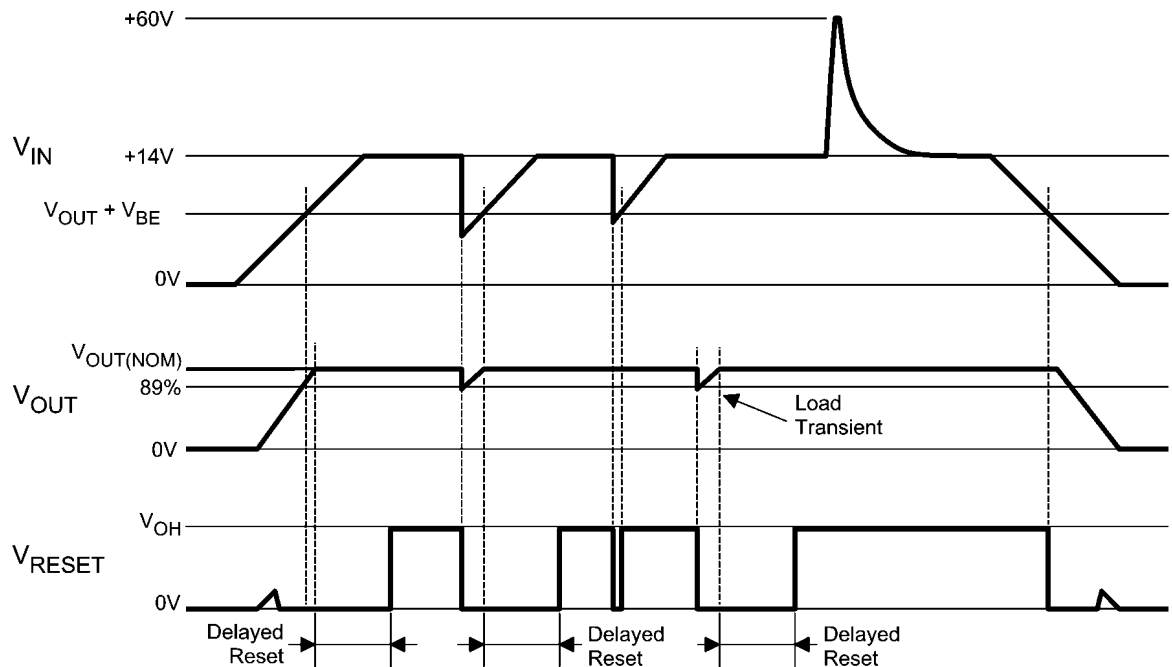

20083049

FIGURE 2. Typical  $\overline{\text{RESET}}$  Pin Operational Waveforms

**Physical Dimensions** inches (millimeters) unless otherwise noted

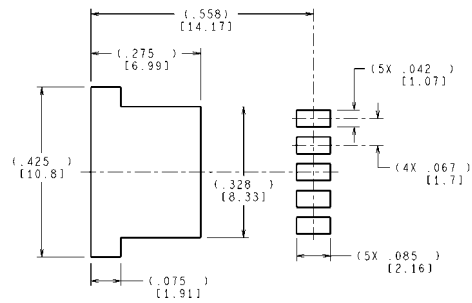
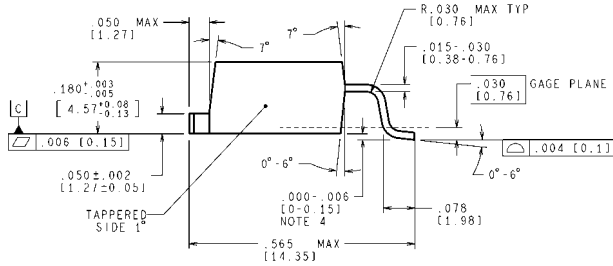
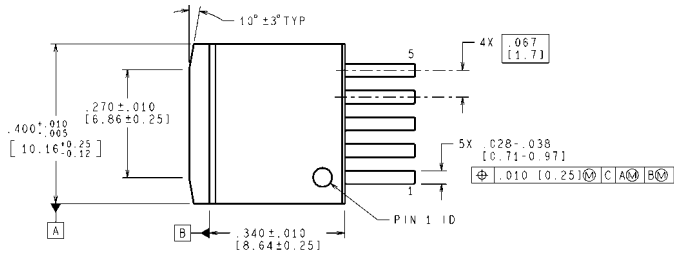

LAND PATTERN RECOMMENDATION

CONTROLLING DIMENSION IS INCH  
VALUES IN ( ) ARE MILLIMETERS  
DIMENSIONS IN ( ) FOR REFERENCE ONLY

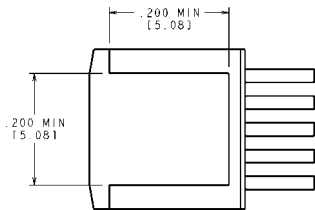

TS5B (Rev D)

**5-Lead TO-263  
NS Package Number TS5B**

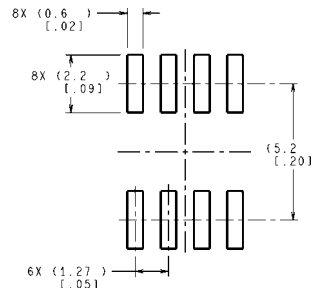
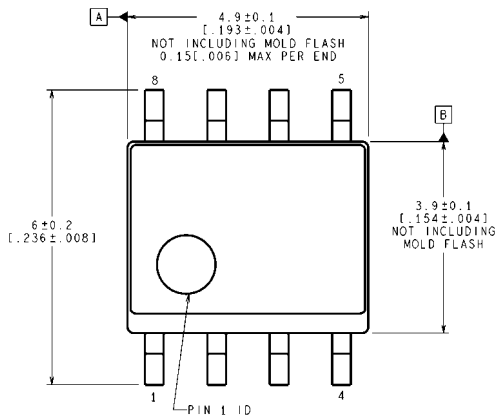

RECOMMENDED LAND PATTERN

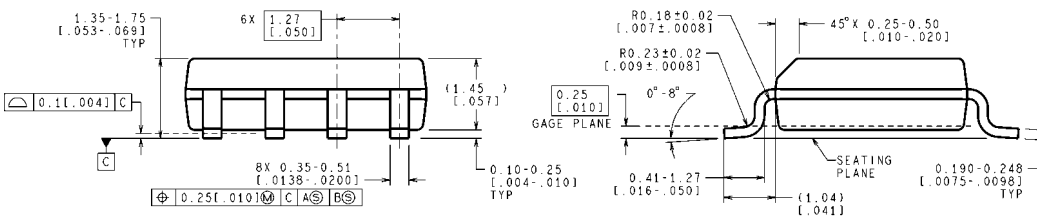

CONTROLLING DIMENSION IS MILLIMETER  
VALUES IN ( ) ARE INCHES  
DIMENSIONS IN ( ) FOR REFERENCE ONLY

M08A (Rev L)

**8-Lead (0.150" Wide) Molded SO Package  
NS Package Number M08A**

## Notes

For more National Semiconductor product information and proven design tools, visit the following Web sites at:

Products		Design Support	
Amplifiers	<a href="http://www.national.com/amplifiers">www.national.com/amplifiers</a>	WEBENCH	<a href="http://www.national.com/webench">www.national.com/webench</a>
Audio	<a href="http://www.national.com/audio">www.national.com/audio</a>	Analog University	<a href="http://www.national.com/AU">www.national.com/AU</a>
Clock Conditioners	<a href="http://www.national.com/timing">www.national.com/timing</a>	App Notes	<a href="http://www.national.com/appnotes">www.national.com/appnotes</a>
Data Converters	<a href="http://www.national.com/adc">www.national.com/adc</a>	Distributors	<a href="http://www.national.com/contacts">www.national.com/contacts</a>
Displays	<a href="http://www.national.com/displays">www.national.com/displays</a>	Green Compliance	<a href="http://www.national.com/quality/green">www.national.com/quality/green</a>
Ethernet	<a href="http://www.national.com/ethernet">www.national.com/ethernet</a>	Packaging	<a href="http://www.national.com/packaging">www.national.com/packaging</a>
Interface	<a href="http://www.national.com/interface">www.national.com/interface</a>	Quality and Reliability	<a href="http://www.national.com/quality">www.national.com/quality</a>
LVDS	<a href="http://www.national.com/lvds">www.national.com/lvds</a>	Reference Designs	<a href="http://www.national.com/refdesigns">www.national.com/refdesigns</a>
Power Management	<a href="http://www.national.com/power">www.national.com/power</a>	Feedback	<a href="http://www.national.com/feedback">www.national.com/feedback</a>
Switching Regulators	<a href="http://www.national.com/switchers">www.national.com/switchers</a>		
LDOs	<a href="http://www.national.com/ldo">www.national.com/ldo</a>		
LED Lighting	<a href="http://www.national.com/led">www.national.com/led</a>		
PowerWise	<a href="http://www.national.com/powerwise">www.national.com/powerwise</a>		
Serial Digital Interface (SDI)	<a href="http://www.national.com/sdi">www.national.com/sdi</a>		
Temperature Sensors	<a href="http://www.national.com/tempensors">www.national.com/tempensors</a>		
Wireless (PLL/VCO)	<a href="http://www.national.com/wireless">www.national.com/wireless</a>		

THE CONTENTS OF THIS DOCUMENT ARE PROVIDED IN CONNECTION WITH NATIONAL SEMICONDUCTOR CORPORATION ("NATIONAL") PRODUCTS. NATIONAL MAKES NO REPRESENTATIONS OR WARRANTIES WITH RESPECT TO THE ACCURACY OR COMPLETENESS OF THE CONTENTS OF THIS PUBLICATION AND RESERVES THE RIGHT TO MAKE CHANGES TO SPECIFICATIONS AND PRODUCT DESCRIPTIONS AT ANY TIME WITHOUT NOTICE. NO LICENSE, WHETHER EXPRESS, IMPLIED, ARISING BY ESTOPPEL OR OTHERWISE, TO ANY INTELLECTUAL PROPERTY RIGHTS IS GRANTED BY THIS DOCUMENT.

TESTING AND OTHER QUALITY CONTROLS ARE USED TO THE EXTENT NATIONAL DEEMS NECESSARY TO SUPPORT NATIONAL'S PRODUCT WARRANTY. EXCEPT WHERE MANDATED BY GOVERNMENT REQUIREMENTS, TESTING OF ALL PARAMETERS OF EACH PRODUCT IS NOT NECESSARILY PERFORMED. NATIONAL ASSUMES NO LIABILITY FOR APPLICATIONS ASSISTANCE OR BUYER PRODUCT DESIGN. BUYERS ARE RESPONSIBLE FOR THEIR PRODUCTS AND APPLICATIONS USING NATIONAL COMPONENTS. PRIOR TO USING OR DISTRIBUTING ANY PRODUCTS THAT INCLUDE NATIONAL COMPONENTS, BUYERS SHOULD PROVIDE ADEQUATE DESIGN, TESTING AND OPERATING SAFEGUARDS.

EXCEPT AS PROVIDED IN NATIONAL'S TERMS AND CONDITIONS OF SALE FOR SUCH PRODUCTS, NATIONAL ASSUMES NO LIABILITY WHATSOEVER, AND NATIONAL DISCLAIMS ANY EXPRESS OR IMPLIED WARRANTY RELATING TO THE SALE AND/OR USE OF NATIONAL PRODUCTS INCLUDING LIABILITY OR WARRANTIES RELATING TO FITNESS FOR A PARTICULAR PURPOSE, MERCHANTABILITY, OR INFRINGEMENT OF ANY PATENT, COPYRIGHT OR OTHER INTELLECTUAL PROPERTY RIGHT.

### LIFE SUPPORT POLICY

**NATIONAL'S PRODUCTS ARE NOT AUTHORIZED FOR USE AS CRITICAL COMPONENTS IN LIFE SUPPORT DEVICES OR SYSTEMS WITHOUT THE EXPRESS PRIOR WRITTEN APPROVAL OF THE CHIEF EXECUTIVE OFFICER AND GENERAL COUNSEL OF NATIONAL SEMICONDUCTOR CORPORATION.** As used herein:

Life support devices or systems are devices which (a) are intended for surgical implant into the body, or (b) support or sustain life and whose failure to perform when properly used in accordance with instructions for use provided in the labeling can be reasonably expected to result in a significant injury to the user. A critical component is any component in a life support device or system whose failure to perform can be reasonably expected to cause the failure of the life support device or system or to affect its safety or effectiveness.

National Semiconductor and the National Semiconductor logo are registered trademarks of National Semiconductor Corporation. All other brand or product names may be trademarks or registered trademarks of their respective holders.

Copyright© 2007 National Semiconductor Corporation

For the most current product information visit us at [www.national.com](http://www.national.com)



**National Semiconductor Americas Customer Support Center**  
 Email: [new.feedback@nsc.com](mailto:new.feedback@nsc.com)  
 Tel: 1-800-272-9959

**National Semiconductor Europe Customer Support Center**  
 Fax: +49 (0) 180-530-85-86  
 Email: [europe.support@nsc.com](mailto:europe.support@nsc.com)  
 Deutsch Tel: +49 (0) 69 9508 6208  
 English Tel: +49 (0) 870 24 0 2171  
 Français Tel: +33 (0) 1 41 91 8790

**National Semiconductor Asia Pacific Customer Support Center**  
 Email: [ap.support@nsc.com](mailto:ap.support@nsc.com)

**National Semiconductor Japan Customer Support Center**  
 Fax: 81-3-5639-7507  
 Email: [jpn.feedback@nsc.com](mailto:jpn.feedback@nsc.com)  
 Tel: 81-3-5639-7560