

TW9910 – Low Power NTSC/PAL/SECAM Video Decoder with VBI Slicer

Data Sheet

Techwell Confidential. Information may change without notice.

Disclaimer

This document provides technical information for the user. Techwell, Inc. reserves the right to modify the information in this document as necessary. The customer should make sure that they have the most recent data sheet version. Techwell, Inc. holds no responsibility for any errors that may appear in this document. Customers should take appropriate action to ensure their use of the products does not infringe upon any patents. Techwell, Inc. respects valid patent rights of third parties and does not infringe upon or assist others to infringe upon such rights.

Techwell, Inc.	1	0x1B – Output Control II	41
Disclaimer.....	1	0x1C – Standard Selection (SDT)	42
Features	3	0x1D – Standard Recognition (SDTR)	43
Functional Description	4	0x1E – Reserved.....	43
Introduction.....	4	0x1F – Test Control Register (TEST).....	44
Introduction.....	5	0x20 – Clamping Gain (CLMPG)	45
Analog Front End.....	5	0x21 – Individual AGC Gain (IAGC).....	45
Sync Processor.....	5	0x22 – AGC Gain (AGCGAIN).....	45
Y/C separation.....	5	0x23 – White Peak Threshold (PEAKWT).....	45
Color demodulation.....	6	0x24 – Clamp level (CLMPL).....	45
Automatic Chroma Gain Control.....	6	0x25 – Sync Amplitude (SYNCT).....	46
Color Killer.....	6	0x26 – Sync Miss Count Register (MISSCNT).....	46
Automatic standard detection.....	6	0x27 – Clamp Position Register (PCLAMP).....	46
Component Processing.....	7	0x28 – Vertical Control I (VCNTL1).....	47
Sharpness.....	7	0x29 – Vertical Control II (VCNTL2).....	47
Color Transient Improvement.....	7	0x2A – Color Killer Level Control (CKILL).....	47
Power Management.....	7	0x2B – Comb Filter Control (COMB).....	48
Host Interface.....	7	0x2C – Luma Delay and H Filter Control (LDLY).....	48
Down-scaling and Cropping.....	8	0x2D – Miscellaneous Control I (MISC1).....	49
Cropping.....	8	0x2E – LOOP Control Register (LOOP).....	49
Output Interface.....	10	0x2F – Miscellaneous Control II (MISC2).....	50
ITU-R BT.656.....	10	0x30 – Macrovision Detection (MVSND).....	51
Horizontal Down Scaling Output.....	10	0x31 – Chip STATUS II (STATUS2).....	51
Vertical Down Scaling Output.....	11	0x32 – H monitor (HFREF).....	52
VBI Data Processing.....	12	0x33 – CLAMP MODE (CLMD).....	52
Raw VBI data output.....	12	0x34 – ID Detection Control (IDCNTL).....	52
VBI Data Slicer.....	12	0x35 – Clamp Control I (CLCNTL1).....	53
Sliced VBI Data output format.....	13	0x4F – WSS3.....	54
Two Wire Serial Bus Interface.....	20	0x50 – FILLDATA.....	54
Test Modes.....	22	0x51 – SDID.....	54
Filter Curves.....	23	0x52 – DID.....	54
Anti-alias filter.....	23	0x53 – WSS1.....	55
Decimation filter.....	23	0x54 – WSS2.....	55
Chroma Band Pass Filter Curves.....	24	0x55 – VVBI.....	55
Luma Notch Filter Curve for NTSC and PAL/SECAM.....	24	0x56-6A LCTL6-LCTL26.....	56
Chrominance Low-Pass Filter Curve.....	25	0x6B – HSGEGIN.....	56
Horizontal Scaler Pre- Filter curves.....	25	0x6C – HSEND.....	56
Peaking Filter Curves.....	25	0x6D – OVSDLY.....	56
Peaking Filter Curves.....	26	0x6E – OVSEND.....	57
Peaking Filter Curves.....	26	0x6F – VBIDELAY.....	57
Control Register	27	Pin Diagram	58
TW9910 Register SUMMARY.....	27	44 PIN LQFP.....	58
0x00 – Product ID Code Register (ID).....	30	Pin Diagram	59
0x01 – Chip Status Register I (STATUS1).....	30	48 PIN QFN Pin Description.....	59
0x02 – Input Format (INFORM).....	31	Pin Description.....	60
0x03 – Output Format Control Register (OPFORM).....	32	Power and Ground Pins.....	61
0x04 – Color Killer Hysteresis and HSYNC Delay Control.....	32	Parametric Information	62
0x05 – Output Control I.....	33	AC/DC Electrical Parameters.....	62
0x06 – Analog Control Register (ACNTL).....	34	Clock Timing Diagram.....	64
0x07 – Cropping Register, High (CROP_HI).....	34	Mechanical Data.....	64
0x08 – Vertical Delay Register, Low (VDELAY_LO).....	35	Mechanical Data.....	65
0x09 – Vertical Active Register, Low (VACTIVE_LO).....	35	44 Pin LQFP.....	65
0x0A – Horizontal Delay Register, Low (HDELAY_LO).....	35	48 PIN QFN.....	67
0x0B – Horizontal Active Register, Low (HACTIVE_LO).....	35	Application Schematics.....	69
0x0C – Control Register I (CNTRL1).....	36	PCB Layout Considerations.....	70
0x0D – Vertical Scaling Register, Low (VSCALE_LO).....	36	Copyright Notice	71
0x0E – Scaling Register, High (SCALE_HI).....	36	Disclaimer	71
0x0F – Horizontal Scaling Register, Low (HSCALE_LO).....	37	Life Support Policy	71
0x10 – BRIGHTNESS Control Register (BRIGHT).....	37		
0x11 – CONTRAST Control Register (CONTRAST).....	37		
0x12 – SHARPNESS Control Register I (SHARPNESS).....	37		
0x13 – Chroma (U) Gain Register (SAT_U).....	38		
0x14 – Chroma (V) Gain Register (SAT_V).....	38		
0x15 – Hue Control Register (HUE).....	38		
0x16 – Reserved.....	38		
0x17 – Coring.....	39		
0x18 – Coring and IF compensation (CORING).....	39		
0x19 – VBI Control Register (VBICNTL).....	40		
0x1A – Analog Control II.....	41		

TW9910 – Low Power NTSC/PAL/SECAM Video Decoder with VBI Slicer

Features

Video decoder

- NTSC (M, 4.43) and PAL (B, D, G, H, I, M, N, N combination), PAL (60), SECAM support with automatic format detection
- Software selectable analog inputs allows any of the following combinations, e.g. 4 CVBS or (3 CVBS and 1 Y/C).
- Built-in analog anti-alias filter
- Two 10-bit ADCs and analog clamping circuit.
- Fully programmable static gain or automatic gain control for the Y channel
- Programmable white peak control for the Y channel
- 4-H adaptive comb filter Y/C separation
- PAL delay line for color phase error correction
- Image enhancement with peaking and CTI.
- Digital sub-carrier PLL for accurate color decoding
- Digital Horizontal PLL for synchronization processing and pixel sampling
- Advanced synchronization processing and sync detection for handling non-standard and weak signal
- Programmable hue, brightness, saturation, contrast, and sharpness.
- Automatic color control and color killer
- Chroma IF compensation
- Detection of level of copy protection according to Macrovision standard
- ITU-R 601 or ITU-R 656 compatible YCbCr(4:2:2) output format
- VBI slicer supporting industrial standard data services
- VBI data pass through, raw ADC data output

Video scaler

- High quality horizontal filtered scaling with arbitrary scale down ratio
- Phase accuracy better than 1/32 pixel
- Programmable output cropping

Miscellaneous

- Two wire MPU serial bus interface
- Support Real Time Control interface
- Power save and Power down mode
- Typical power consumption <100mW
- Single 27MHz crystal for all standards
- Supports 24.54MHz and 29.5MHz crystal for high resolution square pixel format decoding
- 3.3V tolerant I/O
- 1.8V/3.3 V power supply
- 44pin LQFP, 48pin QFN package

Functional Description

Figure 1: TW9910 Block Diagram

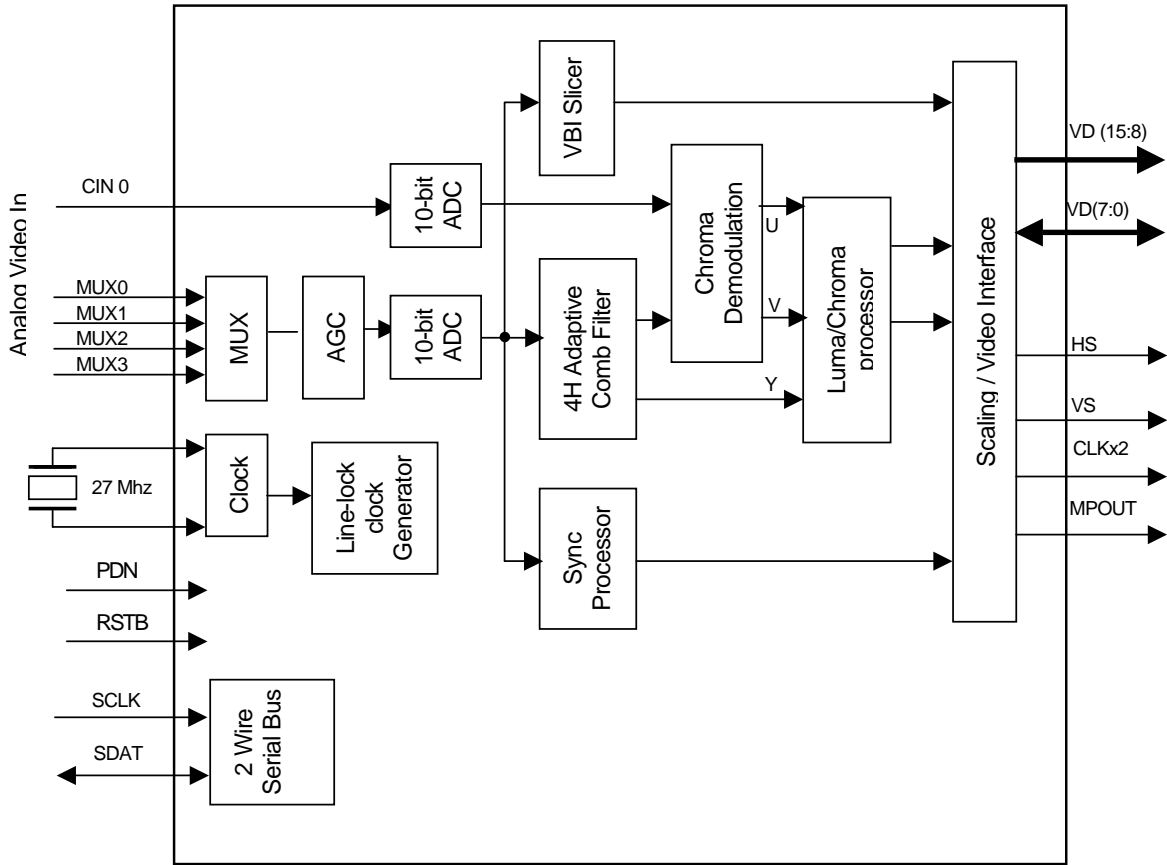

Introduction

The TW9910 is a low power NTSC/PAL/SECAM video decoder chip that is designed for portable applications. It consumes less than 100mW in typical composite input application. The available power down mode further reduces the power consumption. It uses the 1.8V for both analog and digital supply voltage and 3.3V for I/O power. A single 27MHz crystal is all that needed to decode all analog video standards.

The video decoder decodes the base-band analog CVBS or S-video signals into digital 8 or 16-bit 4:2:2 YCbCr for output. It consists of analog front-end with input source selection, variable gain amplifier and analog-to-digital converters, Y/C separation circuit, multi-standard color decoder (PAL BGHI, PAL M, PAL N, combination PAL N, NTSC M, NTSC 4.43 and SECAM) and synchronization circuitry. The Y/C separation is done with high quality adaptive 4H comb filter for reduced cross color and cross luminance. The advanced synchronization processing circuitry can produce stable pictures for non-standard signal as well as weak signal. A video scaler is provided to arbitrarily scale down the output video in a packed format. The output of the decoder is line-locked and formatted to the ITU-R 656 output with embedded sync.

The TW9910 also includes circuits to detect and process vertical blanking interval (VBI) signal. It slices and process VBI data for output through video bus. Some information can also be alternatively retrieved through host interface. It also detects copy-protected signal according to Macrovision standard including AGC and colorstripe pulses.

A 2-wire serial host interface is used to simplify system integration. All the functions can be controlled through this interface.

Analog Front End

The analog front-end prepares and digitizes the AC coupled analog signal for further processing. Both channels have built-in anti-alias filter and 10-bit over-sampling ADCs. The characteristic of the filter is available in the filter curve section. The Y channel has additional 4-input multiplexer, and a variable gain amplifier for automatic gain control (AGC). It can support a maximum input voltage range of 1.4V without attenuation. The C channel has only one input with built-in clamping circuit that restores the DC level. Software selectable analog inputs allow two possible input combinations:

1. Four selectable composite video inputs.
2. Three selectable composites and one S-video input.

Sync Processor

The sync processor of TW9910 detects horizontal synchronization and vertical synchronization signals in the composite video or in the Y signal of an S-video or component signal. The processor contains a digital phase-locked-loop and decision logic to achieve reliable sync detection in stable signal as well as in unstable signals such as those from VCR fast forward or backward. It allows the sampling of the video signal in line-locked fashion.

Y/C separation

For NTSC and PAL standard signals, the luma/chroma separation can be done either by adaptive comb filtering or notch/band-pass filter combination. For SECAM standard signals, only notch/band-pass filter is available. The default selection for NTSC/PAL is comb filter. The characteristics of the band-pass filter are shown in the filter curve section.

TW9910 employs high quality 4-H adaptive comb filter to reduce artifacts like hanging dots and crawling dots. Due to the line buffer used in the comb filter, there is always two lines processing delay in the output images no matter what standard or filter option is chosen.

Color demodulation

The color demodulation of NTSC and PAL signal is done by first quadrature down mixing and then low-pass filtering. The low-pass filter characteristic can be selected for optimized transient color performance. For the PAL system, the PAL ID or the burst phase switching is identified to aid the PAL color demodulation.

The SECAM decoding process consists of FM demodulator and de-emphasis filtering. During the FM demodulation, the chroma carrier frequency is identified and used to control the SECAM color demodulation.

The sub-carrier signal for use in the color demodulator is generated by direct digital synthesis PLL that locks onto the input sub-carrier reference (color burst). This arrangement allows any sub-standard of NTSC and PAL to be demodulated easily with single crystal frequency.

Automatic Chroma Gain Control

The Automatic Chroma Gain Control (ACC) compensates for reduced amplitudes caused by high-frequency loss in video signal. The range of ACC control is -6db to $+26\text{db}$.

Color Killer

For low color amplitude signals, black and white video, or very noisy signals, the color will be "killed". The color killer uses the burst amplitude measurement as well as sub-carrier PLL status to switch-off the color.

Automatic standard detection

The TW9910 has build-in automatic standard discrimination circuitry. The circuit uses burst-phase, burst-frequency and frame rate to identify NTSC, PAL or SECAM color signals. The standards that can be identified are NTSC (M), NTSC (4.43), PAL (B, D, G, H, I), PAL (M), PAL (N), PAL (60) and SECAM (M). Each standard can be included or excluded in the standard recognition process by software control. The identified standard is indicated by the Standard Selection (SDT) register. Automatic standard detection can be overridden by software controlled standard selection.

TW9910 supports all common video formats as shown in Table 1. The video decoder needs to be programmed appropriately for each of the composite video input formats.

Table 1. Video Input Formats Supported by the TW9910

Format	Lines	Fields	Fsc	Country
NTSC-M	525	60	3.579545 MHz	U.S., many others
NTSC-Japan (1)	525	60	3.579545 MHz	Japan
PAL-B, G, N	625	50	4.433619 MHz	Many
PAL-D	625	50	4.433619 MHz	China
PAL-H	625	50	4.433619 MHz	Belgium
PAL-I	625	50	4.433619 MHz	Great Britain, others
PAL-M	525	60	3.575612 MHz	Brazil
PAL-CN	625	50	3.582056 MHz	Argentina
SECAM	625	50	4.406MHz 4.250MHz	France, Eastern Europe, Middle East, Russia
PAL-60	525	60	4.433619 MHz	China
NTSC (4.43)	525	60	4.433619 MHz	Transcoding

Notes: (1). NTSC-Japan has 0 IRE setup.

Component Processing

The TW9910 supports the brightness, contrast, color saturation and Hue adjustment for changing the video characteristic. The Cb and Cr gain can be adjusted independently for flexibility.

Sharpness

The TW9910 also provides a sharpness control function through control registers. It provides the control up to +9db. The center frequency of the enhancement curve is selectable. A coring function is provided to prevent noise enhancement.

Color Transient Improvement

A programmable Color Transient Improvement circuit is provided to enhance the color bandwidth. Low level noise enhancement can be suppressed by a programmable coring logic. Overshoot and undershoot are also removed by special circuit to prevent false color generation at the color edge.

Power Management

The TW9910 can be put into power-down mode through both software and hardware control. The Y and C path can be separately powered down.

Host Interface

The TW9910 registers are accessed via 2-WIRE SERIAL MPU interface. It operates as a slave device. Serial clock and data lines, SCLK and SDAT, transfer data from the bus master at a rate of 400 Kbits/s. The TW9910 has one serial interface address select pin(VD[0]/SIAD0) to program up to two unique serial addresses TW9910. This allows as many as two TW9910 to share the same serial bus. Reset signals are also available to reset the control registers to their default values.

Down-scaling and Cropping

The TW9910 provides two methods to reduce the amount of output video pixel data, downscaling and cropping. The downscaling provides full video image at lower resolution. Cropping provides only a portion of the video image output. All these mechanisms can be controlled independently to yield maximum flexibility in the output stream.

The TW9910 can independently reduce the output video image size in both horizontal and vertical directions using arbitrary scaling ratios up to 1/16 in each direction. The horizontal scaling employs a dynamic 6-tap 32-phase interpolation filter for luma and a 2-tap 8-phase interpolation filter for chroma. The vertical scaling uses the simple line dropping method. It is recommended to choose integer vertical scaling ratio for best result.

The horizontal scaling factor can be calculated according to following equation:

$$\text{HSCALE} = [\text{HACTIVE} / N_{\text{pixel_desired}}] * 256$$

Where: $N_{\text{pixel_desired}}$ is the number of output pixels per line and HACTIVE is the programmed number of captured pixels per line.

The vertical scaling factor is determined as

$$\text{VSCALE} = [\text{VACTIVE} / N_{\text{line_desired}}] * 256$$

Where: $N_{\text{line_desired}}$ is the number of active lines output per field and VACTIVE is the programmed number of captured lines per field.

Cropping

Cropping allows only subsection of a video image to be output. The VACTIVE signal can be programmed to indicate the number of active lines to be displayed in a video field, and the HACTIVE signal can be programmed to indicate the number of active pixels to be displayed in a video line. The start of the field or frame in the vertical direction is indicated by the leading edge of VSYNC. The start of the line in the horizontal direction is indicated by the leading edge of the HSYNC. The start of the active lines from vertical sync edge is indicated by the VDELAY register. The start of the active pixels from the horizontal edge is indicated by the HDELAY register. The sizes and location of the active video are determined by HDELAY, HACTIVE, VDELAY, and VACTIVE registers. These registers are 8-bit wide, the lower 8-bits is, respectively, in HDELAY_LO, HACTIVE_LO, VDELAY_LO, and VACTIVE_LO. Their upper 2-bit shares the same register CROP_HI.

In order for the cropping to work properly, the following equation should be satisfied.

$$\text{HDELAY} + \text{HACTIVE} < \text{Total number of pixels per line.}$$

$$\text{VDELAY} + \text{VACTIVE} < \text{Total number of lines per field}$$

Table 2 shows some popular video formats and its recommended register settings. The CCIR601 format refers to the sampling rate of 13.5 MHz. The SQ format for 60 Hz system refers to the sampling rate of 12.27 MHz, and the SQ format for 50 Hz system refers to the use of sampling rate of 14.75 MHz.

Scaling Ratio	Format	Total Resolution	Output Resolution	HSCALE values	VSCALE (frame)
1:1	NTSC SQ	780x525	640x480	0x0100	0x0100
	NTSC CCIR601	858x525	720x480	0x0100	0x0100
	PAL SQ	944x625	768x576	0x0100	0x0100
	PAL CCIR601	864x625	720x576	0x0100	0x0100
2:1 (CIF)	NTSC SQ	390x262	320x240	0x0200	0x0200
	NTSC CCIR601	429x262	360x240	0x0200	0x0200
	PAL SQ	472x312	384x288	0x0200	0x0200
	PAL CCIR601	432x312	360x288	0x0200	0x0200
4:1 (QCIF)	NTSC SQ	195x131	160x120	0x0400	0x0400
	NTSC CCIR601	214x131	180x120	0x0400	0x0400
	PAL SQ	236x156	192x144	0x0400	0x0400
	PAL CCIR601	216x156	180x144	0x0400	0x0400

Table 2. HSCALE and VSCALE value for some popular video formats.

Output Interface

ITU-R BT.656

ITU-R BT.656 defines strict EAV/SAV Code, video data output timing, H blanking timing, and V Blanking timing. In this mode, VD[15:8] pins are only effective and CLKx2 pin should be used for data clock signal. EAV/SAV Code format is shown as follows. Bit 7 of forth byte in EAV/SAV code must be "1" in ITU-R BT.656 standard. For that reason, VIPCFG Register bit must be set to "1".

Table3. ITU-R BT.656 SAV and EAV code sequence

	VD15	VD14	VD13	VD12	VD11	VD10	VD9	VD8
1st byte	1	1	1	1	1	1	1	1
2nd byte	0	0	0	0	0	0	0	0
3rd byte	0	0	0	0	0	0	0	0
4th byte	*C	F	V	H	V XOR H	F XOR H	F XOR V	F XOR V XOR H

*C is set by VIPCFG register bit.

For complete IRU-R BT.656 standard, following setting is recommended.

Table 4. ITU-R BT.656 Register set up

Register	525 line system	625 line system
MODE	1	1
LEN	0	0
VDELAY	0x012	0x018
VACTIVE	0X0F4	0x120
HACTIVE	0x2D0	0x2D0
HA_EN	1	1
VIPCFG	1	1
NTSC656	1	0

ITU-R BT.656 for 525-line system has 244 video active lines in odd field and 243 vide active lines in even field. NTSC656 register bit controls this video active line length.

Horizontal Down Scaling Output

TW9910 generates Horizontal down scaling output data. Figure 2 shows 8 bit mode Horizontal Down Scaling output timing. As shown on Figure 2, Horizontal Down Scaled data are generated by continuous data stream. The trailing edge of DVALID signal changes with the trailing edge of HACTIVE signal. Data value from the leading edge of HACTIVE to the leading edge of DVALID is programmable by CNTL656 register. If CNTL656 is set to "1", all Y and CbCr data will be 0x00. If CNTL656 is set to "0", all Y data will be 0x10 and all CbCr data will be 0x80. VIP application normally uses 0x00 data as invalid data. Figure 2 shows 360 active pixels output timing after horizontal downscaling.

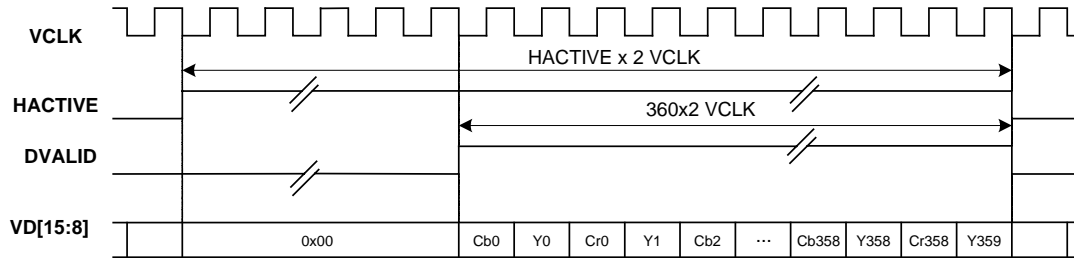

Figure 2. 8 bit mode Horizontal Down Scaling Output

Vertical Down Scaling Output

TW9910 generates Vertical Down Scaling output data. Figure 3 shows its timing. As shown on Figure 3, HACTIVE is NOT generated on invalid line as default (VSCTL is "0"). If VSCTL is set to "1", HACTIVE is generated on every lines during VACTIVE active period. DVALID is not generated on invalid lines in each setting. Invalid lines for Vertical down scaling are generated during VACTIVE active period. If MODE bit is set to "1" for VIP mode, EAV/SAV codes are not generated on those lines without HACTIVE signal. All CbCr data will be 80H and all Y data will be 10H the same as H-blanking data in ITU-R BT.656 data stream.

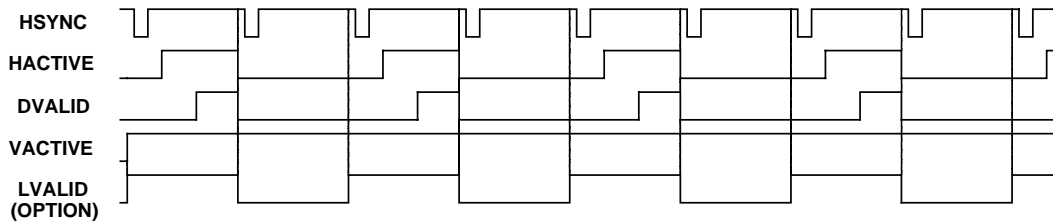

Figure 3. Vertical Down Scaling Output

VBI Data Processing

Raw VBI data output

TW9910 supports raw VBI data output. Raw VBI data output has the same vertical line delay timing as video output. Horizontal output timing is also programmable by VBIDELAY register. Raw VBI data is generated during HACTIVE active period (from SAV to EAV) as Video data output. Total pixel number of raw VBI data per line is twice as many as HACTIVE register value. If VBI EN register is set to "1", all vertical blanking output while VACTIVE is inactive will be raw VBI data output. If VVBI registers are set to more than "1", the VVBI number lines from top video active lines will also be raw VBI data output lines.

VBI Data Slicer

The following VBI standards are supported by VBI Data slicer. The VBI Data slicing is controlled by the registers LCTL6 to LCTL26. Registers LCTL6 to LCTL26 are controlling the slicing process itself. LCTL6 to LCTL26 defines the Data Type to be decoded. The Data Type can be specified on a line by line basis for line6 to line26 and for even and odd field depending on the detected TV system standard. The setting for LCTL26 is valid for the rest of the corresponding field. Normally no text data 0H (video data) should be selected to render the VBI Data slicer inactive during active video. LCTRL26 is useful for Full-Field Teletext mode in the case of NABTS.

NABTS is 525 Teletext-C. Japan's MOJI is 525 Teletext-D. Didon Antiope is 625 Teletext-A. VBI Data slicer supports up to Physical layer, Link layer in ITU-R BT.653-2. Japan's EIAJ CPR-1204 shown as 525 WSS has the same physical layer protocol as that of CGMS.

The sliced VBI data is embedded in the ITU-R BT.656 output stream, using the intervals between the End of Active Video (EAV) and the Start of Active Vide(SAV) codes of each line and formatted according to ITU-R BT.1364 Ancillary data packet Type 2.

Table 5. VBI Standard.

STANDARD TYPE	TV Systems (lines/freq)	Bit Rate (Mbits/s)	Modulation	Data Type
625 Teletext-B	625/50	6.9375	NRZ	1H
525 Teletext-B	525/60	5.727272	NRZ	1H
625 Teletext-C	625/50	5.734375	NRZ	2H
525 Teletext-C	525/60	5.727272	NRZ	2H
625 Teletext-D	625/50	5.6427875	NRZ	3H
525 Teletext-D	525/60	5.727272	NRZ	3H
625 CC	625/50	0.500	NRZ	4H
525 CC	525/60	0.503	NRZ	4H
625 WSS	626/50	5	Bi-phase	5H
525 WSS(CGMS)	525/60	0.447443	NRZ	5H
625 VITC	625/50	1.8125	NRZ	6H
525 VITC	525/60	1.7898	NRZ	6H
Gemstar 2x	525/60	1.007	NRZ	7H
Gemstar 1x	525/60	0.503	NRZ	8H
VPS	625/50	5	Bi-phase	9H
625 Teletext-A	625/50	6.203125	NRZ	AH

Sliced VBI Data output format

After 4 bytes of EAV code, sliced VBI ANC data packets are generated by following format. Byte1 to Byte4N+7 data stream is formatted according to ITU-R BT.1364 ANC data packet type2. BC data byte is optional and not included in ANC data packet type 2 BC data byte is inserted after ANC data packet type2.

Table 6. Sliced VBI ANC data packet

BYTE No.	D7 MSB	D6	D5	D4	D3	D2	D1	D0 LSB	DESCRIPTION
1	0	0	0	0	0	0	0	0	Ancillary data flag
2	1	1	1	1	1	1	1	1	
3	1	1	1	1	1	1	1	1	
4	NEP	EP	0	DID4	DID3	DID2	DID1	DID0	DID
5	NEP	EP	SDID5	SDID4	SDID3	SDID2	SDID1	SDID0	SDID
6	NEP	EP	DC5	DC4	DC3	DC2	DC1	DC0	DC
7	OP	FID	LN8	LN7	LN6	LN5	LN4	LN3	IDI1. UDW1
8	OP	LN2	LN1	LN0	DT3	DT2	DT1	DT0	IDI2. UDW 2
9	Sliced VBI Data byte 1								Sliced VBI Data No.1. UDW3
10	Sliced VBI Data byte 2								Sliced VBI Data No.2. UDW4
11	Sliced VBI Data byte 3								Sliced VBI Data No.3. UDW5
12	Sliced VBI Data byte 4								Sliced VBI Data No.4. UDW6
13	Sliced VBI Data byte 5								Sliced VBI Data No.5. UDW7
.	.								
.	.								
4N+6	Sliced VBI Data byte last or FILLDATA								Sliced VBI Data Last or FILLDATA. UDW 4N
4N+7	NCS6	CS6	CS5	CS4	CS3	CS2	CS1	CS0	CS
4N+8	OP	0	BC5	BC4	BC3	BC2	BC1	BC0	BC

1. EP is Even Parity of bits 5 to 0 in same 1 byte.
2. NEP is inverted EP in same 1 byte.
3. {DID4,DID3,DID2,DID1,DID0} is DID register value.
4. {SDID5,SDID4,SDID3,SDID2,SDID1,SDID0} is SDID register value.
5. {DC5,DC4,DC3,DC2,DC1,DC0} is the number of DOWRD data length from UDW1 to UDW4N. On this table, {DC5,DC4,DC3,DC2,DC1,DC0} is N(decimal).
6. OP is Odd Parity of bits 6 to 0 in same 1 byte.
7. FID=0: odd field ; FID=1: even field.
8. {LN8,LN7,LN6,LN5,LN4,LN3,LN2,LN1,LN0} is the line number of current sliced VBI data.
9. {DT3,DT2,DT1,DT0} is the Data Type shown on Table
10. NCS6 is inverted CS6.
11. {CS6,CS5,CS4,CS3,CS2,CS1,CS0} is the checksum value calculated from DID to UDW4N.
12. UDW1 to UDW4N are the User data words(UDW) shown on ITU-R BT.1364 ANC data packet type 2.
13. [BC5,BC4,BC3,BC2,BC1,BC0] is the number of valid bytes from UDW1 to UDW4N.
14. FILLDATA is FILLDATA register value. FILLDATA is inserted after last valid bytes to make 4N number byte stream sometimes.

Following shows various type of ANC data packet to be output

Table 7. Closed Captioning ANC data packet

BYTE No.	D7 MSB	D6	D5	D4	D3	D2	D1	D0 LSB	DESCRIPTION
1	0	0	0	0	0	0	0	0	Ancillary data flag
2	1	1	1	1	1	1	1	1	
3	1	1	1	1	1	1	1	1	
4	NEP	EP	0	DID4	DID3	DID2	DID1	DID0	DID
5	NEP	EP	SDID5	SDID4	SDID3	SDID2	SDID1	SDID0	SDID
6	0	1	0	0	0	0	0	1	DC
7	OP	FID	LN8	LN7	LN6	LN5	LN4	LN3	IDI1. UDW1
8	OP	LN2	LN1	LN0	0	1	0	0	IDI2. UDW 2
9	1 st Character byte								UDW3
10	2 nd Character byte								UDW4
11	NCS6	CS6	CS5	CS4	CS3	CS2	CS1	CS0	CS
12	0	0	0	0	0	1	0	0	BC

Table 8. CGMS ANC data packet

BYTE No.	D7 MSB	D6	D5	D4	D3	D2	D1	D0 LSB	DESCRIPTION
1	0	0	0	0	0	0	0	0	Ancillary dataflag
2	1	1	1	1	1	1	1	1	
3	1	1	1	1	1	1	1	1	
4	NEP	EP	0	DID4	DID3	DID2	DID1	DID0	DID
5	NEP	EP	SDID5	SDID4	SDID3	SDID2	SDID1	SDID0	SDID
6	0	1	0	0	0	0	1	0	DC
7	OP	FID	LN8	LN7	LN6	LN5	LN4	LN3	IDI1. UDW1
8	OP	LN2	LN1	LN0	0	1	0	1	IDI2. UDW 2
9	WSS[7:0]								UDW3
10	WSS[15:8]								UDW4
11	{0H,WSS[19:16]}								UDW5
12	CRCERRORCODE								UDW6
13	FILLDATA								UDW7
14	FILLDATA								UDW8
15	NCS6	CS6	CS5	CS4	CS3	CS2	CS1	CS0	CS
16	1	0	0	0	0	1	1	0	BC

1.CRCERRORCODE is optional byte. 41H means "this wss data has CRC Error". 80H means no CRC error.

Table 9. 625 line Wide Screen signaling ANC data packet

BYTE No.	D7 MSB	D6	D5	D4	D3	D2	D1	D0 LSB	DESCRIPTION
1	0	0	0	0	0	0	0	0	Ancillary dataflag
2	1	1	1	1	1	1	1	1	
3	1	1	1	1	1	1	1	1	
4	NEP	EP	0	DID4	DID3	DID2	DID1	DID0	DID
5	NEP	EP	SDID5	SDID4	SDID3	SDID2	SDID1	SDID0	SDID
6	0	1	0	0	0	0	0	1	DC
7	OP	FID	LN8	LN7	LN6	LN5	LN4	LN3	IDI1. UDW1
8	OP	LN2	LN1	LN0	0	1	0	1	IDI2. UDW 2
9	WSS[7:0]								UDW3
10	{00b,WSS[13:8]}								UDW4

12	NCS6	CS6	CS5	CS4	CS3	CS2	CS1	CS0	CS
13	0	0	0	0	0	1	0	0	BC

Table 10. 625 Teletext-A ANC data packet

BYTE No.	D7 MSB	D6	D5	D4	D3	D2	D1	D0 LSB	DESCRIPTION
1	0	0	0	0	0	0	0	0	Ancillary dataflag
2	1	1	1	1	1	1	1	1	
3	1	1	1	1	1	1	1	1	
4	NEP	EP	0	DID4	DID3	DID2	DID1	DID0	DID
5	NEP	EP	SDID5	SDID4	SDID3	SDID2	SDID1	SDID0	SDID
6	0	1	0	0	1	0	1	1	DC
7	OP	FID	LN8	LN7	LN6	LN5	LN4	LN3	ID11. UDW1
8	OP	LN2	LN1	LN0	1	0	1	0	ID12. UDW 2
9	FRAME CDDE								UDW3
10	BYTE4								UDW4
11	BYTE5								UDW5
.	.								
.	.								
46	BYTE40								UDW40
47	HAMM84ERROR								UDW41
48	FILLDATA								UDW42
49	FILLDATA								UDW43
50	FILLDATA								UDW44
51	NCS6	CS6	CS5	CS4	CS3	CS2	CS1	CS0	CS
52	0	0	1	0	1	0	0	1	BC

1.FRAME CODE is E7H if it's received correctly.

2.HAMM84ERROR is 41H if more than 1 8/4 Hamming code error in this packet,80H means no 8/4 Hamming error.

Table 11. 625 Teletext-B ANC data packet

BYTE No.	D7 MSB	D6	D5	D4	D3	D2	D1	D0 LSB	DESCRIPTION
1	0	0	0	0	0	0	0	0	Ancillary dataflag
2	1	1	1	1	1	1	1	1	
3	1	1	1	1	1	1	1	1	
4	NEP	EP	0	DID4	DID3	DID2	DID1	DID0	DID
5	NEP	EP	SDID5	SDID4	SDID3	SDID2	SDID1	SDID0	SDID
6	1	0	0	0	1	1	0	0	DC
7	OP	FID	LN8	LN7	LN6	LN5	LN4	LN3	ID11. UDW1
8	OP	LN2	LN1	LN0	0	0	0	1	ID12. UDW 2
9	FRAME CDDE								UDW3
10	BYTE4								UDW4
11	BYTE5								UDW5
.	.								
.	.								
50	BYTE44								UDW44
51	BYTE45								UDW45
52	HAMM84ERROR								UDW46
53	FILLDATA								UDW47
54	FILLDATA								UDW48
55	NCS6	CS6	CS5	CS4	CS3	CS2	CS1	CS0	CS
56	1	0	1	0	1	1	1	0	BC

1.FRAME CODE is 27H if it's received correctly.

2.HAMM84ERROR is 41H if more than 1 8/4 Hamming code error in this packet,80H means no 8/4 Hamming error.

Table 12. 525 Teletext-B ANC data packet

BYTE No.	D7 MSB	D6	D5	D4	D3	D2	D1	D0 LSB	DESCRIPTION
1	0	0	0	0	0	0	0	0	Ancillary dataflag
2	1	1	1	1	1	1	1	1	
3	1	1	1	1	1	1	1	1	
4	NEP	EP	0	DID4	DID3	DID2	DID1	DID0	DID
5	NEP	EP	SDID5	SDID4	SDID3	SDID2	SDID1	SDID0	SDID
6	1	0	0	0	1	0	1	0	DC
7	OP	FID	LN8	LN7	LN6	LN5	LN4	LN3	IDI1. UDW1
8	OP	LN2	LN1	LN0	0	0	0	1	IDI2. UDW 2
9	FRAME CDDE								UDW3
10	BYTE4								UDW4
11	BYTE5								UDW5
.	.								
.	.								
30	BYTE36								UDW36
31	BYTE37								UDW37
32	HAMM84ERROR								UDW38
33	FILLDATA								UDW39
34	FILLDATA								UDW40
35	NCS6	CS6	CS5	CS4	CS3	CS2	CS1	CS0	CS
36	1	0	1	0	0	1	1	0	BC

1.FRAME CODE is 27H if it's received correctly.

2.HAMM84ERROR is 41H if more than 1 8/4 Hamming code error in this packet,80H means no 8/4 Hamming error.

Table 13. 625 Teletext-C and 525 Teletext-C ANC data packet

BYTE No.	D7 MSB	D6	D5	D4	D3	D2	D1	D0 LSB	DESCRIPTION
1	0	0	0	0	0	0	0	0	Ancillary dataflag
2	1	1	1	1	1	1	1	1	
3	1	1	1	1	1	1	1	1	
4	NEP	EP	0	DID4	DID3	DID2	DID1	DID0	DID
5	NEP	EP	SDID5	SDID4	SDID3	SDID2	SDID1	SDID0	SDID
6	1	0	0	0	1	0	1	0	DC
7	OP	FID	LN8	LN7	LN6	LN5	LN4	LN3	IDI1. UDW1
8	OP	LN2	LN1	LN0	0	0	1	0	IDI2. UDW 2
9	FRAME CDDE								UDW3
10	BYTE4								UDW4
11	BYTE5								UDW5
.	.								
.	.								
42	BYTE36								UDW36
43	HAMM84ERROR								UDW37
44	FILLDATA								UDW38
45	FILLDATA								UDW39
46	FILLDATA								UDW40
47	NCS6	CS6	CS5	CS4	CS3	CS2	CS1	CS0	CS
48	0	0	1	0	0	1	0	1	BC

1.FRAME CODE is E7H if it's received correctly.

2.HAMM84ERROR is 41H if more than 1 8/4 Hamming code error in this packet,80H means no 8/4 Hamming error.

Table 14. 625 Teletext-D and 525 Teletext-D ANC data packet

BYTE No.	D7 MSB	D6	D5	D4	D3	D2	D1	D0 LSB	DESCRIPTION
1	0	0	0	0	0	0	0	0	Ancillary dataflag
2	1	1	1	1	1	1	1	1	
3	1	1	1	1	1	1	1	1	
4	NEP	EP	0	DID4	DID3	DID2	DID1	DID0	DID
5	NEP	EP	SDID5	SDID4	SDID3	SDID2	SDID1	SDID0	SDID
6	1	0	0	0	1	0	1	0	DC
7	OP	FID	LN8	LN7	LN6	LN5	LN4	LN3	IDI1. UDW1
8	OP	LN2	LN1	LN0	0	0	1	1	IDI2. UDW 2
9	FRAME CDDE								UDW3
10	BYTE4								UDW4
11	BYTE5								UDW5
.	.								
.	.								
42	BYTE36								UDW36
43	BYTE37								UDW37
44	FILLDATA								UDW38
45	FILLDATA								UDW39
46	FILLDATA								UDW40
47	NCS6	CS6	CS5	CS4	CS3	CS2	CS1	CS0	CS
48	0	0	1	0	0	1	0	1	BC

1.FRAME CODE is A7H if it's received correctly.

Table 15. Line16 VPS ANC data packet

BYTE No.	D7 MSB	D6	D5	D4	D3	D2	D1	D0 LSB	DESCRIPTION
1	0	0	0	0	0	0	0	0	Ancillary dataflag
2	1	1	1	1	1	1	1	1	
3	1	1	1	1	1	1	1	1	
4	NEP	EP	0	DID4	DID3	DID2	DID1	DID0	DID
5	NEP	EP	SDID5	SDID4	SDID3	SDID2	SDID1	SDID0	SDID
6	1	0	0	0	0	1	0	1	DC
7	OP	FID	LN8	LN7	LN6	LN5	LN4	LN3	IDI1. UDW1
8	OP	LN2	LN1	LN0	1	0	0	1	IDI2. UDW 2
9	START CDDE1(51H)								UDW3
10	START CODE2(99H)								UDW4
11	BYTE3								UDW5
.	.								
.	.								
22	BYTE14								UDW16
23	BYTE15								UDW17
24	BI-PHASEERROR								UDW18
25	FILLDATA								UDW19
26	FILLDATA								UDW20
27	NCS6	CS6	CS5	CS4	CS3	CS2	CS1	CS0	CS
28	1	0	0	1	0	0	1	0	BC

1.START CODE1 is the first byte of Start Code by 5Mbps slicing.

2.START CODE2 is the second byte of Start Code by 5Mbps slicing.

3.BYTE3-BYTE15 are data bytes by 5/2 Mbps Bi-phase slicing.

4.BI-PHASEERROOR is Bi-phase coding error detection.80H means No error.41H means Bi-phase coding error is detected.

Table 16. VITC ANC data packet

BYTE No.	D7 MSB	D6	D5	D4	D3	D2	D1	D0 LSB	DESCRIPTION
1	0	0	0	0	0	0	0	0	Ancillary dataflag
2	1	1	1	1	1	1	1	1	
3	1	1	1	1	1	1	1	1	
4	NEP	EP	0	DID4	DID3	DID2	DID1	DID0	DID
5	NEP	EP	SDID5	SDID4	SDID3	SDID2	SDID1	SDID0	SDID
6	1	0	0	0	0	0	1	1	DC
7	OP	FID	LN8	LN7	LN6	LN5	LN4	LN3	IDI1. UDW1
8	OP	LN2	LN1	LN0	0	1	1	0	IDI2. UDW 2
9	Bit[9:2]								UDW3
10	Bit[19:12]								UDW4
11	Bit[29:22]								UDW5
12	.Bit[39:32]								UDW6
13	.Bit[49:42]								UDW7
14	Bit[59:52]								UDW8
15	Bit[69:62]								UDW9
16	Bit[79:72]								UDW10
17	Bit[89:82]								UDW11
18	CRCERROR								UDW12
19	NCS6	CS6	CS5	CS4	CS3	CS2	CS1	CS0	CS
20	1	0	0	0	1	1	0	0	BC

1.CRCERROR is CRC Error information.41H means CRC Error is detected.80H means no CRC error.

Table 17. Gemstar 1X ANC data packet

BYTE No.	D7 MSB	D6	D5	D4	D3	D2	D1	D0 LSB	DESCRIPTION
1	0	0	0	0	0	0	0	0	Ancillary dataflag
2	1	1	1	1	1	1	1	1	
3	1	1	1	1	1	1	1	1	
4	NEP	EP	0	DID4	DID3	DID2	DID1	DID0	DID
5	NEP	EP	SDID5	SDID4	SDID3	SDID2	SDID1	SDID0	SDID
6	0	1	0	0	0	0	0	1	DC
7	OP	FID	LN8	LN7	LN6	LN5	LN4	LN3	IDI1. UDW1
8	OP	LN2	LN1	LN0	1	0	0	0	IDI2. UDW 2
9	1 st Character byte								UDW3
10	2 nd Character byte								UDW4
11	NCS6	CS6	CS5	CS4	CS3	CS2	CS1	CS0	CS
12	0	0	0	0	0	1	0	0	BC

Table 18. Gemstar 2X ANC data packet

BYTE No.	D7 MSB	D6	D5	D4	D3	D2	D1	D0 LSB	DESCRIPTION
1	0	0	0	0	0	0	0	0	Ancillary dataflag
2	1	1	1	1	1	1	1	1	
3	1	1	1	1	1	1	1	1	
4	NEP	EP	0	DID4	DID3	DID2	DID1	DID0	DID
5	NEP	EP	SDID5	SDID4	SDID3	SDID2	SDID1	SDID0	SDID
6	0	1	0	0	0	0	1	0	DC
7	OP	FID	LN8	LN7	LN6	LN5	LN4	LN3	IDI1. UDW1
8	OP	LN2	LN1	LN0	0	1	1	1	IDI2. UDW 2
9	FRAMECODE1								UDW3
10	FRAMECODE2								UDW4
11	Data Byte 1								UDW5
12	Data Byte 2								UDW6
13	Data Byte 3								UDW7
14	Data Byte 4								UDW8
15	NCS6	CS6	CS5	CS4	CS3	CS2	CS1	CS0	CS
16	0	0	0	0	1	0	0	0	BC

1. FRAMCODE1 is B9H if Frame Code is correctly received.
2. FRAMCODE2 is 05H if Frame Code is correctly received.

Two Wire Serial Bus Interface

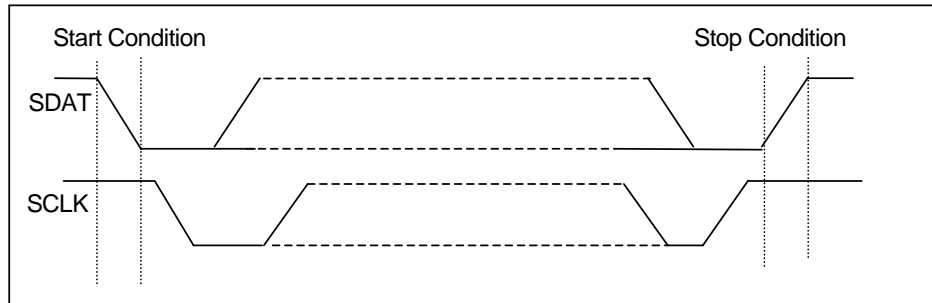

Figure 4. Definition of the serial bus interface bus start and stop

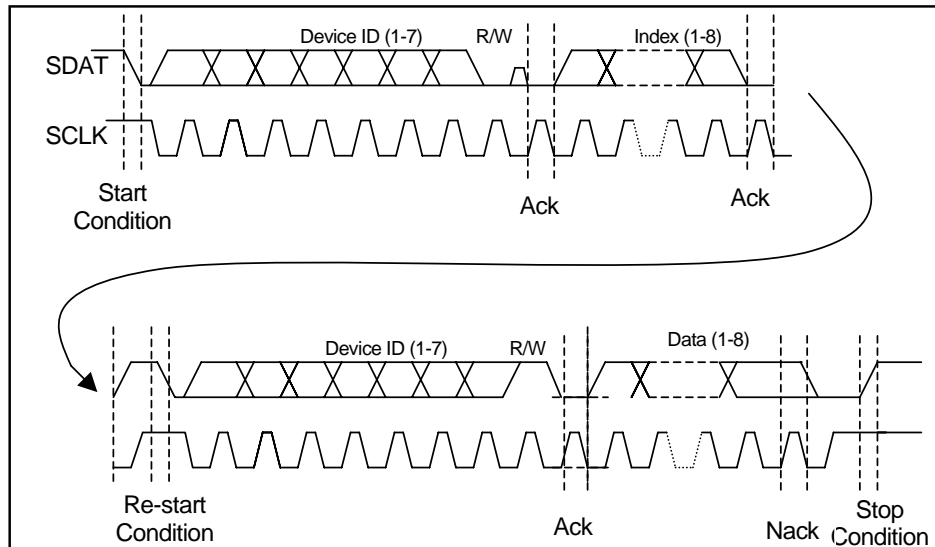

Figure 5. One complete register read sequence via the serial bus interface

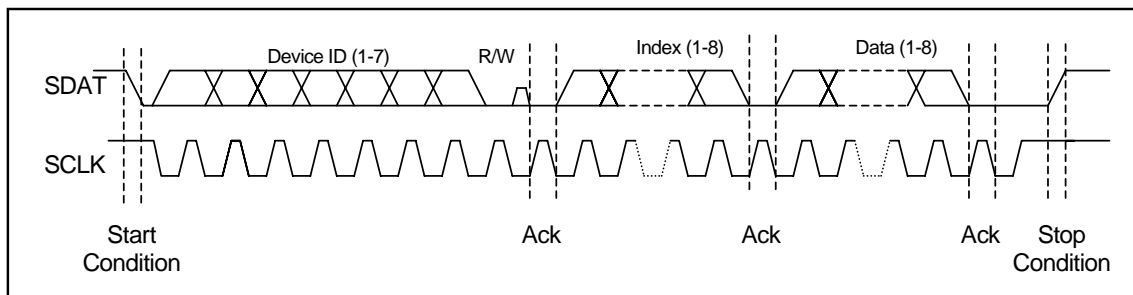

Figure 6. One complete register write sequence via the serial bus interface

The two wire serial bus interface is used to allow an external micro-controller to write control data to, and read control or other information from the TW9910 registers. SCLK is the serial clock and SDAT is the data line. Both lines are pulled high by resistors connected to VDD. ICs communicate on the bus by pulling SCLK and SDAT low through open drain outputs. In normal operation the master generates all clock pulses, but control of the SDAT line alternates back and forth between the master and the slave. For both read and write, each byte is transferred MSB first, and the data bit is valid whenever SCLK is high.

The TW9910 is operated as a bus slave device. It can be programmed to respond to one of two 7-bit slave device addresses by tying the SIAD (Serial Interface Address) pin either to VDD or VSS (See Table 19) through a pull-up or pull-down resistor. The SIAD pin is multi-purpose pin and must not be tied to VDD or VSS directly. If the SIAD pin is tied to VDD, then the least significant bit of the 7-bit address is a "1". If the SIAD pin is tied to VSS then the least significant bit of the 7-bit address is a "0". The most significant 6-bits are fixed. The 7-bit address field is concatenated with the read/write control bit to form the first byte transferred during a new transfer. If the read/write control bit is high the next byte will be read from the slave device. If it is low the next byte will be a write to the slave. When a bus master (the host microprocessor) drives SDAT from high to low, while SCLK is high, this is defined to be a start condition (See Figure 4.). All slaves on the bus listen to determine when a start condition has been asserted.

After a start condition, all slave devices listen for their device addresses. The host then sends a byte consisting of the 7-bit slave device ID and the R/W bit. This is shown in Figure 5. (For the TW9910, the next byte is normally the index to the TW9910 registers and is a write to the TW9910 therefore the first R/W bit is normally low.)

After transmitting the device address and the R/W bit, the master must release the SDAT line while holding SCLK low, and wait for an acknowledgement from the slave. If the address matches the device address of a slave, the slave will respond by driving the SDAT line low to acknowledge the condition. The master will then continue with the next 8-bit transfer. If no device on the bus responds, the master transmits a stop condition and ends the cycle. Notice that a successful transfer always includes nine clock pulses.

To write to the internal register of the TW9910, the master sends another 8-bits of data, the TW9910 loads this to the register pointed by the internal index register. The TW9910 will acknowledge the 8-bit data transfer and automatically increment the index in preparation for the next data. The master can do multiple writes to the TW9910 if they are in ascending sequential order. After each 8-bit transfer the TW9910 will acknowledge the receipt of the 8-bits with an acknowledge pulse. To end all transfers to the TW9910 the host will issue a stop condition.

Serial Bus Interface 7-bit Slave Address							Read/Write bit
1	0	0	0	1	0	SIAD0	1=Read 0=Write

Table 19 TW9910 serial bus interface 7-bit slave address and read write bit

A TW9910 read cycle has two phases. The first phase is a write to the internal index register. The second phase is the read from the data register. (See figure 5). The host initiates the first phase by sending the start condition. It then sends the slave device ID together with a 0 in the R/W bit position. The index is then sent followed by either a stop condition or a second start condition. The second phase starts with the second start condition. The master then resends the same slave device ID with a 1 in the R/W bit position to indicate a read. The slave will transfer the contents of the desired register. The master remains in control of the clock. After transferring eight bits, the slave releases and the master takes control of the SDAT line and acknowledges the receipt of data to the slave. To terminate

the last transfer the master will issue a negative acknowledge (SDAT is left high during a clock pulse) and issue a stop condition.

Test Modes

The input pin TMODE combining with RESET# provide different test modes selection. If this pin is low at the rising edge of the RESET# pin and remaining low afterwards, TW9910 is in the normal operating mode. Other test modes can be obtained as shown in Table 20.

Table 20. Test mode selection and description

Test mode	TMODE before RESET# rising edge	TMODE after RESET# rising edge	Description
Normal	0	0	Normal operation mode.
Pin tri-state	0	1	In this mode, all pin output drivers are tri-stated. Pin leakage current parameters can be measured.
Outputs high	1	0	In this mode, all pin output drivers are forced to the high output state. Pin output high voltage, V_{OH} and I_{OH} , can be measured.
Outputs low	1	1	In this mode, all pin output drivers are forced to the low output state. Pin output low voltage, V_{OL} and I_{OL} , can be measured.

Filter Curves

Anti-alias filter

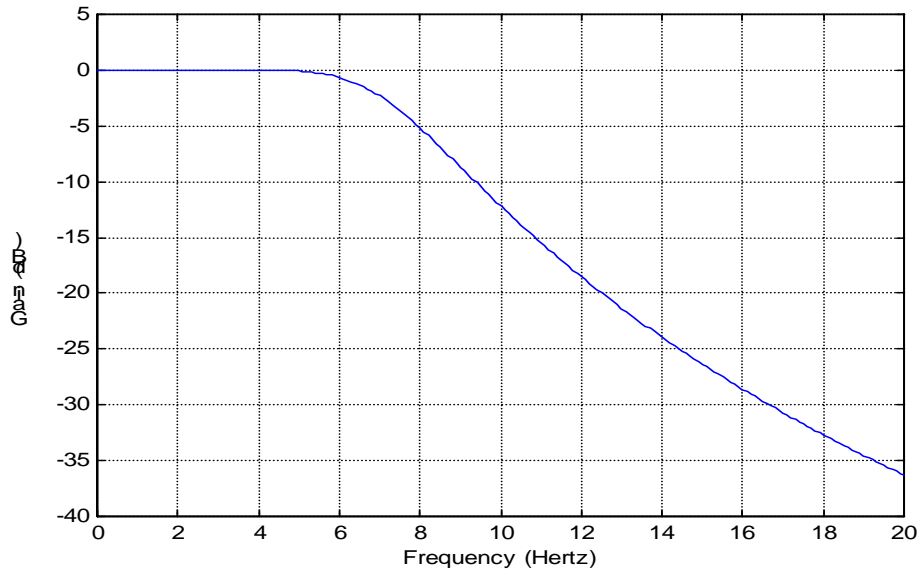

Decimation filter

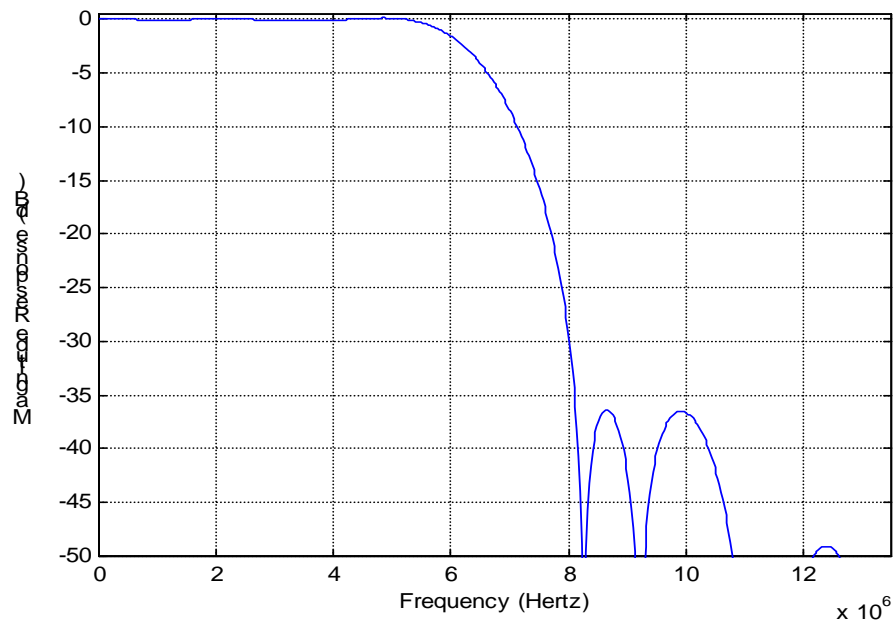

Chroma Band Pass Filter Curves

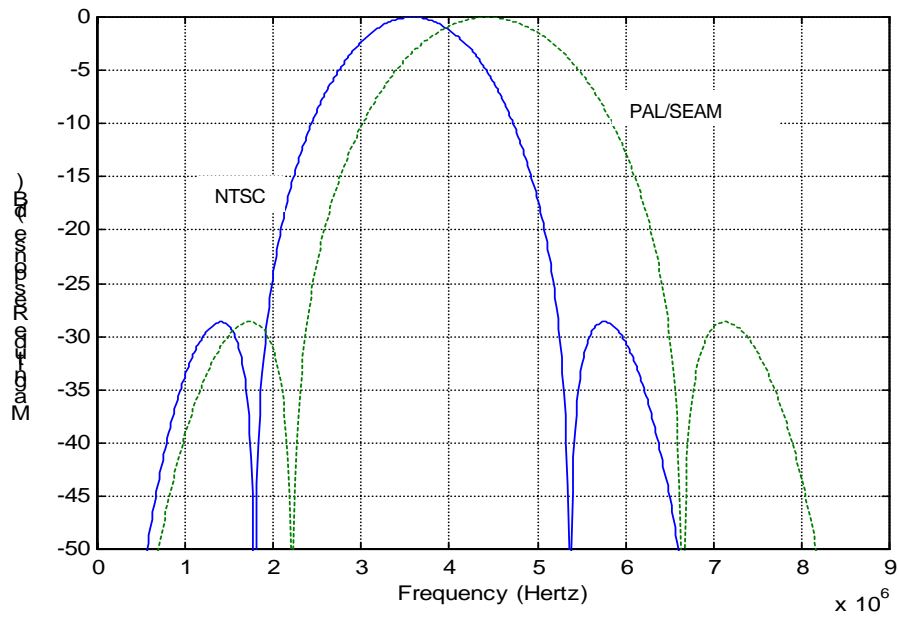

Luma Notch Filter Curve for NTSC and PAL/SECAM

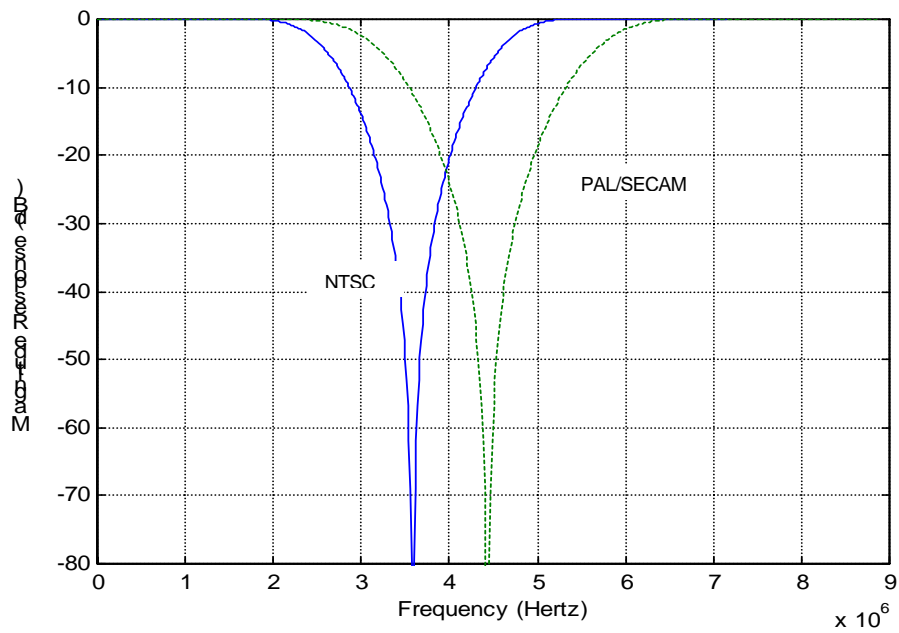

Chrominance Low-Pass Filter Curve

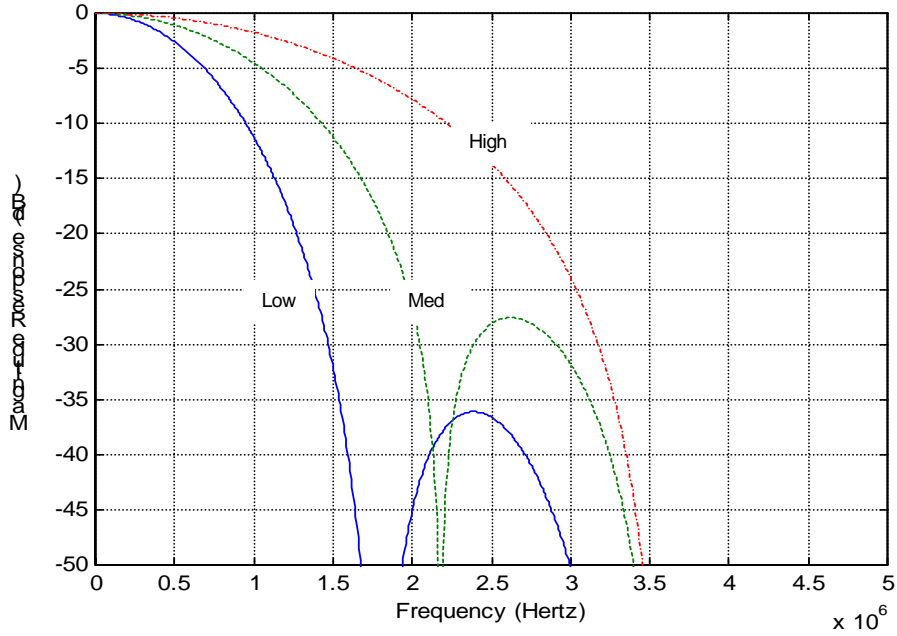

Horizontal Scaler Pre- Filter curves

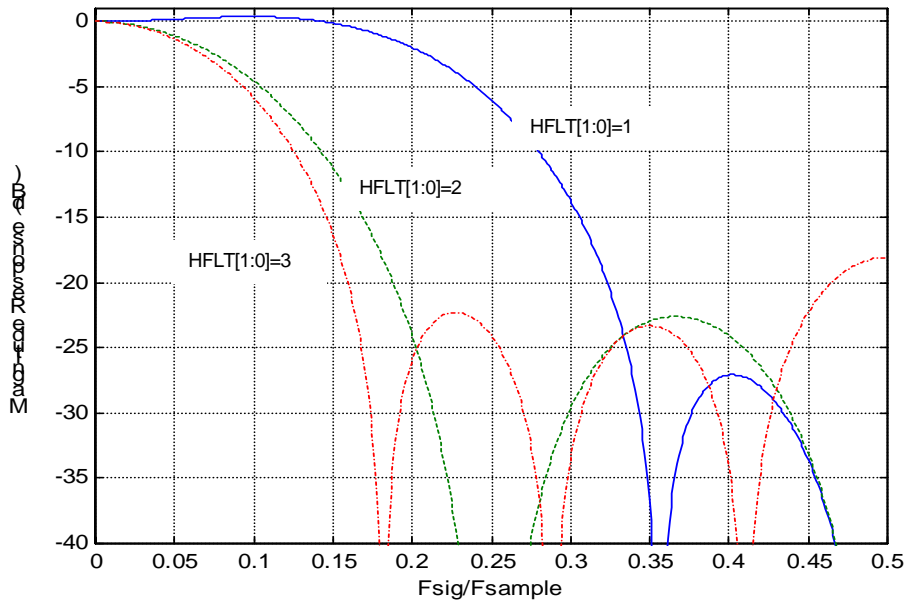

Peaking Filter Curves

NTSC

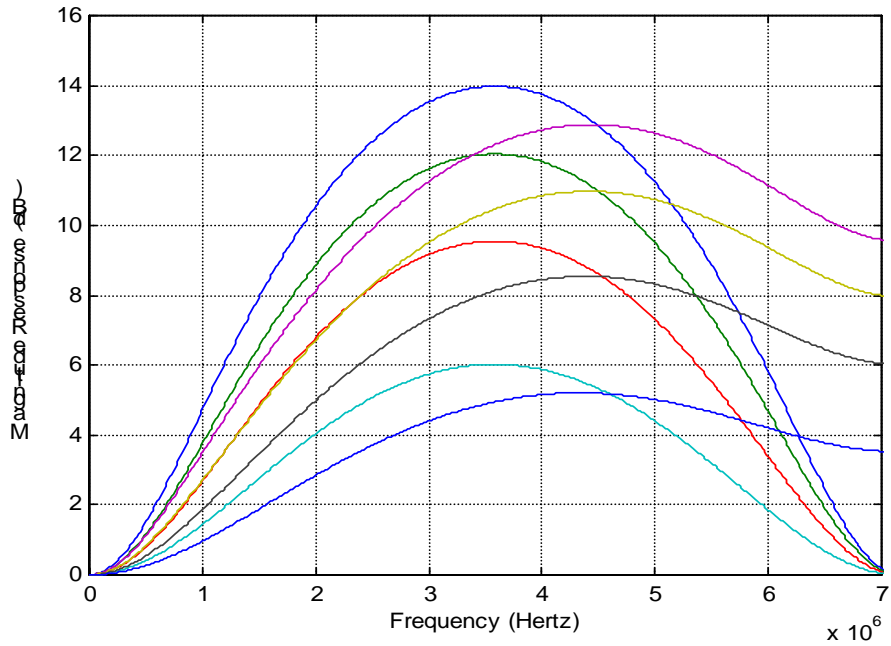

PAL

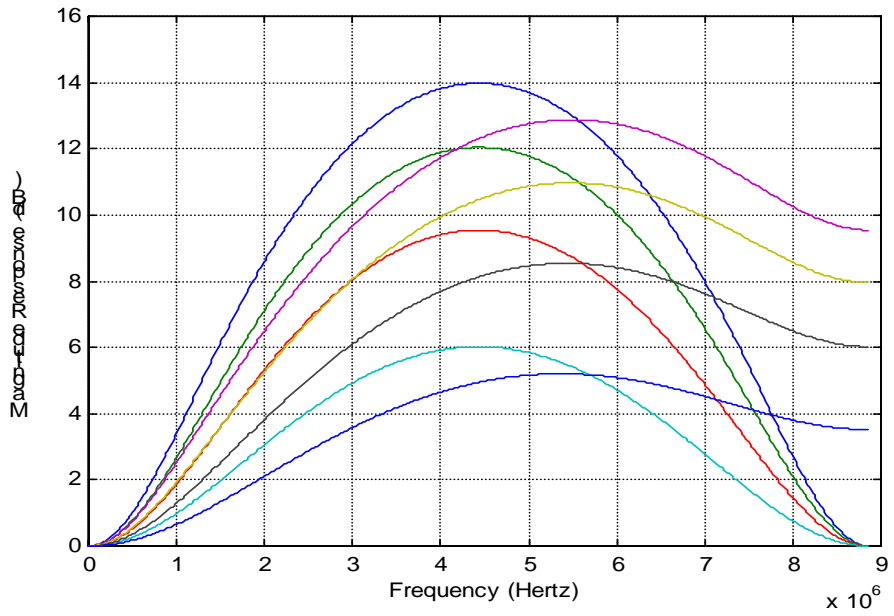

Control Register

TW9910 Register SUMMARY

Index (HEX)	7	6	5	4	3	2	1	0	Reset (hex)
00	ID					REV			58
01	VDLOSS	HLOCK	SLOCK	FIELD	VLOCK	-	MONO	DET50	00
02	YSEL2	FC27	IFSEL		YSEL		CSEL	SEL	40
03	MODE	LEN	LLCMODE	AINC	VSCTL	OEN	TRI_SEL		04
04	GMEN	CKHY		HSDLY					00
05	VSP	VSSL			HSP	HSSL			00
06	SRESET	IREF	VREF	AGC_EN	CLKPDN	Y_PDN	C_PDN	-	00
07	VDELAY_HI		VACTIVE_HI		HDELAY_HI		HACTIVE_HI		02
08	VDELAY_LO								12
09	VACTIVE_LO								F0
0A	HDELAY_LO								0F
0B	HACTIVE_LO								D0
0C	PBW	DEM	PALSW	SET7	COMB	HCOMP	YCOMB	PDLY	CC
0D	VSCALE_LO								00
0E	VSCALE_HI				HSCALE_HI				11
0F	HSCALE_LO								00
10	BRIGHTNESS								00
11	CONTRAST								5C
12	SCURVE	-	CTI		SHARPNESS				11
13	SAT_U								80
14	SAT_V								80
15	HUE								00
16	-				-				00
17	SHCOR				-	VSHP			80
18	CTCOR		CCOR		VCOR		CIF		44
19	VBI_EN	VBI_BYT	VBI_FRAM	HA_EN	CTL656	RTSEL			58
1A	LLCTEST	PLL_PDN	-	-	YFLEN	YSV	CFLEN	CSV	00
1B	CK2S		CK1S		-	-			00
1C	DTSTUS	STDNOW			ATREG	STANDARD			07
1D	START	PAL60	PALCN	PALM	NTSC4	SECAM	PALB	NTSC	7F
1E	-								00
1F	TEST								00

Index (HEX)	7	6	5	4	3	2	1	0	Reset (hex)	
20	CLPEND				CLPST				50	
21	NMGAIN				WPGAIN			Agcgain[8]	22	
22	AGCGAIN[7:0]								F0	
23	PEAKWT								D8	
24	CLMPLD	CLMPL								BC
25	SYNCTD	SYNCT								B8
26	MISSCNT				HSWIN				44	
27	PCLAMP								38	
28	VLCKI	VLCKO		VMODE	DETV	AFLD	VINT		00	
29	BSHT			VSHT					00	
2A	CKILMAX		CKILMIN						78	
2B	HTL				VTL				44	
2C	CKLM	YDLY			EVCNT	HFLT			30	
2D	HPLC	-	PALC	SDET	TBC_EN	BYPAS S	SYOUT	HADV	14	
2E	HPM		ACCT		SPM		CBW		A5	
2F	NKILL	PKILL	SKILL	CBAL	FCS	LCS	CCS	BST	E0	
30	SF	PF	FF	KF	CSBAD	MCVSN	CSTRIPE	CTYPE	00	
31	VCR	WKAIR	WKAIR1	VSTD	NINTL	WSSDET	EDSDET	CCDET	00	
32	HREF								X	
33	FRM		YNR		CLMD		PSP		05	
34	IDX		NSEN / SSEN / PSEN / WKTH						1E	
35	CTEST	YCLEN	CLEN	VLEN	GTEST	VLPF	CKLY	CKLC	00	
36	-									
37	-									
38	-									
39	-									
3A	-									
3B	-									
3C	-									
3D	-									
3E	-									
3F	-									
40	-									
41	-									
42	-									
43	-									
44	-									
45	-									
46	-									
47	-									
48	-									
4E	-									
4F	WSS[19:14]									

Index (HEX)	7	6	5	4	3	2	1	0	Reset (hex)
50	FILLDATA								A0
51	NODAEN	SYRM	SDID						22
52	ANCEN	TOUTH	VIPCFG	DID					31
53	CRCERR	WSSFLD	WSS[13:8]						X
54	WSS[7:0]								X
55	HA656	EAVSW AP	HAMM84	NTSC656	VVBI				00
56	LCTL6								00
57	LCTL7								00
58	LCTL8								00
59	LCTL9								00
5A	LCTL10								00
5B	LCTL11								00
5C	LCTL12								00
5D	LCTL13								00
5E	LCTL14								00
5F	LCTL15								00
60	LCTL16								00
61	LCTL17								00
62	LCTL18								00
63	LCTL19								00
64	LCTL20								00
65	LCTL21								00
66	LCTL22								00
67	LCTL23								00
68	LCTL24								00
69	LCTL25								00
6A	LCTL26								00
6B	HSBEGIN								2C
6C	HSEND								60
6D	OVSDLY								00
6E	HSPIN	OFDLY			VSMODE	OVSEND			20
6F	PDNSV BI	VBIDELAY						24	

0x00 – Product ID Code Register (ID)

Bit	Function	R/W	Description	Reset
7-3	ID	R	The TW9910 Product ID code is 01011.	B
2-0	Revision	R	The revision number.	0

0x01 – Chip Status Register I (STATUS1)

Bit	Function	R/W	Description	Reset
7	VDLOSS	R	1 = Video not present. (Sync is not detected in number of line periods specified by MISSCNT register) 0 = Video detected.	0
6	HLOCK	R	1 = Horizontal sync PLL is locked to the incoming video source. 0 = Horizontal sync PLL is not locked.	0
5	SLOCK	R	1 = Sub-carrier PLL is locked to the incoming video source. 0 = Sub-carrier PLL is not locked.	0
4	FIELD	R	0 = Odd field is being decoded. 1 = Even field is being decoded.	0
3	VLOCK	R	1 = Vertical logic is locked to the incoming video source. 0 = Vertical logic is not locked.	0
2			Reserved	0
1	MONO	R	1 = No color burst signal detected. 0 = Color burst signal detected.	0
0	DET50	R	0 = 60Hz source detected 1 = 50Hz source detected The actual vertical scanning frequency depends on the current standard invoked.	0

0x02 – Input Format (INFORM)

Bit	Function	R/W	Description	Reset
7		R/W	Reserved.	0
6	FC27	R/W	1 = Input crystal clock frequency is 27MHz. 0 = Square pixel mode. Must use 24.54MHz for 60Hz field rate source or 29.5MHz for 50Hz field rate source.	1
5-4	IFSEL	R/W	01 = S-video decoding 00 = Composite video decoding	0
3-2	YSEL	R/W	These two bits control the Y input video selection. 00 = Mux0 selected 01 = Mux1 selected 10 = Mux2 selected 11 = Mux3 selected	0
1		R/W	Reserved	0
0		R/W	Reserved	0

0x03 – Output Format Control Register (OPFORM)

Bit	Function	R/W	Description	Reset
7	MODE	R/W	0 = CCIR601 compatible YCrCb 4:2:2 format with separate syncs and flags. 1 = ITU-R-656 compatible data sequence format.	0
6	LEN	R/W	0 = 8-bit YCrCb 4:2:2 output format. 1 = 16-bit YCrCb 4:2:2 output format.	0
5	LLCMODE	R/W	1 = LLC output mode. 0 = free-run output mode	0
4	AINC	R/W	Serial interface auto-indexing control 0 = auto-increment 1 = non-auto	0
3	VSCTL	R/W	1 = Vertical scale-downed output controlled by DVALID only. 0 = Vertical scale-downed output controlled by both HACTIVE and DVALID.	0
2	OEN	R/W	0 = Enable outputs. 1 = Tri-state outputs defined by Tri-state select bits of this register.	1
1-0	TRI_SEL	R/W	These bits select the outputs to be tri-stated when the OEN bit is asserted high. There are three major groups that can be independently tri-stated: timing group (HS, VS, DVALID, MPOUT, FLD), data group (VD[15:0]), and clock (CLKX2/CLKX1) according to following definition. 00 = Timing and data group only. 01 = Data group only. 10 = All three groups. 11 = Clock and data group only.	0

0x04 – Color Killer Hysteresis and HSYNC Delay Control

Bit	Function	R/W	Description	Reset
7	GMEN	R/W	Reserved for test.	0
6-5	CKHY	R/W	Color killer hysteresis. 0 – fastest 1 – fast 2 – medium 3 - slow	0
4-0	HSDLY	R/W	Reserved for test.	0

0x05 – Output Control I

Bit	Function	R/W	Description	Reset
7	VSP	R/W	0 = VS pin output polarity is active low 1 = VS pin output polarity is active high.	0
6-4	VSSL	R/W	VS pin output control 0 = VSYNC 1 = VACT 2 = FIELD 3 = VVALID 4 - 7 = Reserved	0
3	HSP	R/W	0 = HS pin output polarity is active low 1 = HS pin output polarity is active high.	0
2-0	HSSL	R/W	HS pin output control 0 = HACT 1 = HSYNC 2 = DVALID 3 = HLOCK 4 = ASYNCW 5 - 7 = Reserved	0

0x06 – Analog Control Register (ACNTL)

Bit	Function	R/W	Description	Reset
7	SRESET	W	An 1 written to this bit resets the device to its default state but all register content remain unchanged. This bit is self-resetting.	0
6	IREF	R/W	0 = Internal current reference 1. 1 = Internal current reference 2.	0
5	VREF	R/W	1 = Internal voltage reference. 0 = Internal voltage reference shut down.	0
4	AGC_EN	R/W	0 = AGC loop function enabled. 1 = AGC loop function disabled. Gain is set to by AGCGAIN.	0
3	CLK_PDN	R/W	0 = Normal clock operation. 1 = System clock in power down mode, but the MPU INTERFACE module and output clocks (CLKX1 and CLKX2) are still active.	0
2	Y_PDN	R/W	0 = Luma ADC in normal operation. 1 = Luma ADC in power down mode.	0
1	C_PDN	R/W	0 = Chroma ADC in normal operation. 1 = Chroma ADC in power down mode.	0
0		R/W	Reserved for future use	0

0x07 – Cropping Register, High (CROP_HI)

Bit	Function	R/W	Description	Reset
7-6	VDELAY_HI	R/W	These bits are bit 9 to 8 of the 10-bit Vertical Delay register.	0
5-4	VACTIVE_HI	R/W	These bits are bit 9 to 8 of the 10-bit VACTIVE register. Refer to description on Reg09 for its shadow register.	0
3-2	HDELAY_HI	R/W	These bits are bit 9 to 8 of the 10-bit Horizontal Delay register.	0
1-0	HACTIVE_HI	R/W	These bits are bit 9 to 8 of the 10-bit HACTIVE register.	2

0x08 – Vertical Delay Register, Low (VDELAY_LO)

Bit	Function	R/W	Description	Reset
7-0	VDELAY_LO	R/W	These bits are bit 7 to 0 of the 10-bit Vertical Delay register. The two MSBs are in the CROP_HI register. It defines the number of lines between the leading edge of VSYNC and the start of the active video.	12

0x09 – Vertical Active Register, Low (VACTIVE_LO)

Bit	Function	R/W	Description	Reset
7-0	VACTIVE_LO	R/W	These bits are bit 7 to 0 of the 10-bit Vertical Active register. The two MSBs are in the CROP_HI register. It defines the number of active video lines per frame output. The VACTIVE register has a shadow register for use with 50Hz source when Atreg of Reg0x1C is not set. This register can be accessed through the same index address by first changing the format standard to any 50Hz standard.	F0

0x0A – Horizontal Delay Register, Low (HDELAY_LO)

Bit	Function	R/W	Description	Reset
7-0	HDELAY_LO	R/W	These bits are bit 7 to 0 of the 10-bit Horizontal Delay register. The two MSBs are in the CROP_HI register. It defines the number of pixels between the leading edge of the HSYNC and the start of the image cropping for active video. The HDELAY_LO register has two shadow registers for use with PAL and SECAM sources respectively. These register can be accessed using the same index address by first changing the decoding format to the corresponding standard.	0F

0x0B – Horizontal Active Register, Low (HACTIVE_LO)

Bit	Function	R/W	Description	Reset
7-0	HACTIVE_LO	R/W	These bits are bit 7 to 0 of the 10-bit Horizontal Active register. The two MSBs are in the CROP_HI register. It defines the number of active pixels per line output.	D0

0x0C – Control Register I (CNTRL1)

Bit	Function	R/W	Description	Reset
7	PBW	R/W	1 = Wide Chroma BPF BW 0 = Normal Chroma BPF BW	1
6	DEM	R/W	Secam control 1 = reduction 0 = normal	1
5	PALSW	R/W	1 = PAL switch sensitivity low. 0 = PAL switch sensitivity normal.	0
4	SET7	R/W	1 = The black level is 7.5 IRE above the blank level. 0 = The black level is the same as the blank level.	0
3	COMB	R/W	1 = Adaptive comb filter on for NTSC 0 = Notch filter	1
2	HCOMP	R/W	1 = operation mode 1. (Recommended) 0 = mode 0.	1
1	YCOMB	R/W	This bit controls the no color burst output behavior. 1 = No comb 0 = comb.	0
0	PDLY	R/W	PAL delay line control 1 = disable. 0 = enable.	0

0x0D – Vertical Scaling Register, Low (VSCALE_LO)

Bit	Function	R/W	Description	Reset
7-0	VSCALE_LO	R/W	These bits are bit 7 to 0 of the 12-bit vertical scaling ratio register	00h

0x0E – Scaling Register, High (SCALE_HI)

Bit	Function	R/W	Description	Reset
7-4	VSCALE_HI	R/W	These bits are bit 11 to 8 of the 12-bit vertical scaling ratio register.	1
3-0	HSCALE_HI	R/W	These bits are bit 11 to 8 of the 12-bit horizontal scaling ratio register.	1

0x0F – Horizontal Scaling Register, Low (HSCALE_LO)

Bit	Function	R/W	Description	Reset
7-0	HSCALE_LO	R/W	These bits are bit 7 to 0 of the 12-bit horizontal scaling ratio register.	00

0x10 – BRIGHTNESS Control Register (BRIGHT)

Bit	Function	R/W	Description	Reset
7-0	BRIGHT	R/W	These bits control the brightness. They have value of –128 to 127 in 2's complement form. Positive value increases brightness. A value 0 has no effect on the data.	00

0x11 – CONTRAST Control Register (CONTRAST)

Bit	Function	R/W	Description	Reset
7-0	CNTRST	R/W	These bits control the contrast. They have value of 0 to 3.98 (FFh). A value of 1 ('100_0000') has no effect on the video data.	5C

0x12 – SHARPNESS Control Register I (SHARPNESS)

Bit	Function	R/W	Description	Reset
7	SCURVE	R/W	This bit controls the sharpness filter center frequency. 0 = Normal 1 = High	0
6	VSF	R/W	This bit is for internal used.	1
5-4	CTI	R/W	CTI level selection. 0 = lowest. 3 = highest.	1
3-0	SHARP	R/W	These bits control the amount of sharpness enhancement on the luminance signals. There are 16 levels of control with '0' having no effect on the output image. 1 through 15 provides sharpness enhancement with 'F' being the strongest.	1

0x13 – Chroma (U) Gain Register (SAT_U)

Bit	Function	R/W	Description	Reset
7-0	SAT_U	R/W	These bits control the digital gain adjustment to the U (or Cb) component of the digital video signal. The color saturation can be adjusted by adjusting the U and V color gain components by the same amount in the normal situation. The U and V can also be adjusted independently to provide greater flexibility. The range of adjustment is 0 to 200%.	80

0x14 – Chroma (V) Gain Register (SAT_V)

Bit	Function	R/W	Description	Reset
7-0	SAT_V	R/W	These bits control the digital gain adjustment to the V (or Cr) component of the digital video signal. The color saturation can be adjusted by adjusting the U and V color gain components by the same amount in the normal situation. The U and V can also be adjusted independently to provide greater flexibility. The range of adjustment is 0 to 200%.	80

0x15 – Hue Control Register (HUE)

Bit	Function	R/W	Description	Reset
7-0	HUE	R/W	These bits control the color hue as 2's complement number. They have value from +36° (7Fh) to -36° (80h) with an increment of 0.28°. The positive value gives greenish tone and negative value gives purplish tone. The default value is 0° (00h). This is effective only on NTSC system.	00

0x16 – Reserved

Bit	Function	R/W	Description	Reset
7-4		R/W	Reserved for future use.	0
3-0		R/W	Reserved for future use.	0

0x17 – Coring

Bit	Function	R/W	Description	Reset
7-4	SHCOR	R/W	These bits provide coring function for the sharpness control.	8
3			Reserved	0
2-0	VSHP	R/W	Vertical peaking level. 0 = none. 7 = highest.	0

0x18 – Coring and IF compensation (CORING)

Bit	Function	R/W	Description	Reset
7-6	CTCOR	R/W	These bits control the coring for CTI.	1
5-4	CCOR	R/W	These bits control the low level coring function for the Cb/Cr output.	0
3-2	VCOR	R/W	These bits control the coring function of vertical peaking.	1
1-0	CIF	R/W	These bits control the IF compensation level. 0 = None 1 = 1.5dB 2 = 3dB 3 = 6dB	0

0x19 – VBI Control Register (VBICNTL)

Bit	Function	R/W	Description	Reset
7	VBI_EN	R/W	0 = VBI capture disabled. 1 = VBI capture enabled.	0
6	VBI Byte Order	R/W	If LEN(Reg0x03[6]) is "1" 0 = Pixel 1, 3, 5 ... on the VD[15:8] data bus, and pixel 2, 4, 6, ... on the VD[7:0] data bus. 1 = Pixel 1, 3, 5, ... on the VD[7:0] data bus, and pixel 2, 4, 6, ... on the VD[15:8] data bus. If LEN is "0" 0 = Pixel 2,1,4,3,6,5,... on the VD[15:8] data bus. 1 = Pixel 1,2,3,4,5,6,... on the VD[15:8] data bus.	1
5	VBI_FRAM	R/W	0 = Normal mode 1 = ADC output mode VD[15:8] is Y-ADC data, VD[7:0] pin is C-YADC data	0
4	HA_EN	R/W	0 = HACTIVE output is disabled during vertical blanking period. 1 = HACTIVE output is enabled during vertical blanking period.	1
3	CNTL656	R/W	0 = 0x80 and 0x10 code will be output as invalid data during active video line. 1 = 0x00 code will be output as invalid data during active video line.	1
2-0	RTSEL	R/W	These bits control the real time signal output from the MPOUT pin. 000 = Video loss 001 = H-lock 010 = S-lock 011 = V-lock 100 = MONO 101 = DET50 110 = FIELD 111 = RTCO (Real Time Control)	0

0x1A – Analog Control II

Bit	Function	R/W	Description	Reset
7	LLCTEST	R/W	LLC test mode	0
6	PLL_PDN	R/W	0 = LLC PLL in normal operation. 1 = PLL in power down mode.	0
5-4			Reserved	0
3	YFLEN	R/W	Y-Ch anti-alias filter control 1 = enable 0 = disable	0
2	YSV	R/W	Y-Ch power saving mode 1 = enable 0 = disable	0
1	CFLEN	R/W	C-Ch anti-alias filter control 1 = enable 0 = disable	0
0	CSV	R/W	C-Ch power saving mode 1 = enable 0 = disable	0

0x1B – Output Control II

Bit	Function	R/W	Description	Reset
7-6	CK2S	R/W	CLKX2 pin output control. CK1S[0] together with these two bits (CK1S[0], CK2S) control CLKX2 pin output selection. 000 = VCLK 001 = CLKX1 010 = CLKX2 011 = LLCK 100 = LLCK2 101 = LLCK4	0
5-4	CK1S	R/W	See CK2S	0
3		R/W	Reserved	0
2-0		R/W	Reserved	0

0x1C – Standard Selection (SDT)

Bit	Function	R/W	Description	Reset
7	DETSTUS	R	0 = Idle 1 = detection in progress	0
6-4	STDNOW	R	Current standard invoked 0 = NTSC(M) 1 = PAL (B,D,G,H,I) 2 = SECAM 3 = NTSC4.43 4 = PAL (M) 5 = PAL (CN) 6 = PAL 60 7 = Not valid	0
3	ATREG	R/W	1 = Disable the shadow registers. 0 = Enable VACTIVE and HDELAY shadow registers value depending on standard	0
2-0	STD	R/W	Standard selection 0 = NTSC(M) 1 = PAL (B,D,G,H,I) 2 = SECAM 3 = NTSC4.43 4 = PAL (M) 5 = PAL (CN) 6 = PAL 60 7 = Auto detection	7

0x1D – Standard Recognition (SDTR)

Bit	Function	R/W	Description	Reset
7	ATSTART	R/W	Writing 1 to this bit will manually initiate the auto format detection process. This bit is a self-resetting bit.	0
6	PAL6_EN	R/W	1 = enable recognition of PAL60. 0 = disable recognition.	1
5	PALN_EN	R/W	1 = enable recognition of PAL (CN). 0 = disable recognition.	1
4	PALM_EN	R/W	1 = enable recognition of PAL (M). 0 = disable recognition.	1
3	NT44_EN	R/W	1 = enable recognition of NTSC 4.43. 0 = disable recognition.	1
2	SEC_EN	R/W	1 = enable recognition of SECAM. 0 = disable recognition.	1
1	PALB_EN	R/W	1 = enable recognition of PAL (B,D,G,H,I). 0 = disable recognition.	1
0	NTSC_EN	R/W	1 = enable recognition of NTSC (M). 0 = disable recognition.	1

0x1E – Reserved

Bit	Function	R/W	Description	Reset
7-0		R	Reserved	0

0x1F – Test Control Register (TEST)

Bit	Function	R/W	Description	Reset
7-0	TEST	R/W	<p>This register is reserved for testing purpose. In normal operation, only 0 should be written into this register.</p> <p>1 = Analog test mode. Y and C channel portion of the device can be tested in this mode. The Y channel ADC output can be obtained from VD[15-8]. The C channel ADC output can be obtained from VD[7-0].</p> <p>2 = Clamp test mode. Clamp control YU, YUX, YD, YDX, CU, CUX, CD, and CDX are mapped to VD[3-0].</p> <p>3 = Reserved</p> <p>4 = Digital test mode1. This is the CVBS test mode. The 8-bit input corresponds to VD[7-0] in the order of bit 7 to 0.</p> <p>5 = Digital test mode 2. This is the Y/C test mode. Y input is defined by test mode 1. The C channel data is inputted from VD[7-0]. In this mode, only 8/10-bit output format is allowed.</p> <p>6 = Reserved</p> <p>7 = Reserved</p> <p>8 = Reserved</p> <p>9 = Sync output mode. The 6-bit Sync output corresponds to VD[5-0] in the order of bit 5 to 0. Y and Cb/Cr outputs correspond to VD[15-8] in 422 format</p>	0

0x20 – Clamping Gain (CLMPG)

Bit	Function	R/W	Description	Reset
7-4	CLPEND	R/W	These 4 bits set the end time of the clamping pulse in the increment of 8 system clocks. The clamping period is determined by this and CLPST.	5
3-0	CLPST	R/W	These 4 bits set the start time of the clamping pulse in the increment of 8 system clocks. It is referenced to PCLAMP position.	0

0x21 – Individual AGC Gain (IAGC)

Bit	Function	R/W	Description	Reset
7-4	NMGAIN	R/W	These bits control the normal AGC loop maximum correction value.	2
3-1	WPGAIN	R/W	Peak AGC loop gain control.	1
0	AGCGAIN8	R/W	This bit is the MSB of the 9-bit register that controls the AGC gain when AGC loop is disabled.	0

0x22 – AGC Gain (AGCGAIN)

Bit	Function	R/W	Description	Reset
7-0	AGCGAIN	R/W	These bits are the lower 8 bits of the 9-bit register that controls the AGC gain when AGC loop is disabled.	F0

0x23 – White Peak Threshold (PEAKWT)

Bit	Function	R/W	Description	Reset
7-0	PEAKWT	R/W	These bits control the white peak detection threshold. Setting 'FF' can disable this function.	D8

0x24– Clamp level (CLMPL)

Bit	Function	R/W	Description	Reset
7	CLMPLD	R/W	0 = Clamping level is set by CLMPL. 1 = Clamping level preset at 60d.	1
6-0	CLMPL	R/W	These bits determine the clamping level of the Y channel.	3C

0x25- Sync Amplitude (SYNCT)

Bit	Function	R/W	Description	Reset
7	SYNCTD	R/W	0 = Reference sync amplitude is set by SYNCT. 1 = Reference sync amplitude is preset to 38h.	1
6-0	SYNCT	R/W	These bits determine the standard sync pulse amplitude for AGC reference.	38

0x26 – Sync Miss Count Register (MISSCNT)

Bit	Function	R/W	Description	Reset
7-4	MISSCNT	R/W	MISSCNT[3] controls the speed of VDLOSS detection with '0' being fast and '1' being slow. MISSCNT[2:0] control the threshold of horizontal sync miss detection per field before VDLOSS is flagged.	4
3-0	HSWIN	R/W	These bits determine the VCR mode Hsync detection window.	4

0x27 – Clamp Position Register (PCLAMP)

Bit	Function	R/W	Description	Reset
7-0	PCLAMP	R/W	These bits set the clamping position from the PLL sync edge	38

0x28 – Vertical Control I (VCNTL1)

Bit	Function	R/W	Description	Reset
7-6	VLCKI	R/W	Vertical lock in time. 0 = fastest 3 = slowest.	0
5-4	VLCKO	R/W	Vertical lock out time. 0 = fastest 3 = slowest.	0
3	VMODE	R/W	This bit controls the vertical detection window. 1 = search mode. 0 = vertical count down mode.	0
2	DETV	R/W	1 = recommended for special application only. 0 = Normal Vertical sync logic	0
1	AFLD	R/W	Auto field generation control 0 = Off 1 = On	0
0	VINT	R/W	Vertical integration time control. 1 = long 0 = normal	0

0x29 – Vertical Control II (VCNTL2)

Bit	Function	R/W	Description	Reset
7-5	BSHT	R/W	Burst PLL center frequency control.	0
5-0	VSHT	R/W	Vertical sync output delay control in the increment of half line length.	00

0x2A – Color Killer Level Control (CKILL)

Bit	Function	R/W	Description	Reset
7-6	CKILMAX	R/W	These bits control the amount of color killer hysteresis. The hysteresis amount is proportional to the value.	1
5-0	CKILMIN	R/W	These bits control the color killer threshold. Larger value gives lower killer level.	28

0x2B – Comb Filter Control (COMB)

Bit	Function	R/W	Description	Reset
7	HTL	R/W	Comb strength control. 1= less. 0=more.	0
6-4	HTL	R/W	Adaptive Comb filter threshold control 1.	4
3-0	VTL	R/W	Adaptive Comb filter threshold control 2.	4

0x2C – Luma Delay and H Filter Control (LDLY)

Bit	Function	R/W	Description	Reset
7	CKLM	R/W	Color Killer mode. 0 = normal 1 = fast (for special application)	0
6-4	YDLY	R/W	Luma delay fine adjustment. This 2's complement number provide –4 to +3 unit delay control.	3
3	EVCNT	R/W	1 = Even field counter in special mode. 0 = Normal operation	0
2-0	HFLT	R/W	Pre-filter selection for horizontal scaler 1** = Horizontal enhancement level control 100 = Bypass 000 = Auto selection based on Horizontal scaling ratio. 001 = Recommended for CIF size image 010 = Recommended for QCIF size image 011 = Recommended for ICON size image	0

0x2D – Miscellaneous Control I (MISC1)

Bit	Function	R/W	Description	Reset
7	HPLC	R/W	Reserved for Internal use.	0
6		R/W	Reserved.	
5	PALC	R/W	Reserved.	0
4	SDET	R/W	ID detection sensitivity. A '1' is recommended.	1
3	TBC_EN	R/W	1:TBC enable in freerun clock mode 0:Disable	0
2	BYPASS	R/W	It controls the standard detection and should be set to '1' in normal use.	1
1	SYOUT	R/W	1 = Hsync output is disabled when video loss is detected 0 = Hsync output is always enabled	0
0	HADV	R/W	This bit advances the HACTIVE and DVALID pin output by one data clock when set.	0

0x2E – LOOP Control Register (LOOP)

Bit	Function	R/W	Description	Reset
7-6	HPM	R/W	Horizontal PLL acquisition time. 3 = Fast 2 = Auto1 1 = Auto2 0 = Slow	2
5-4	ACCT	R/W	ACC time constant 0 = No ACC 1 = slow 2 = medium 3 = fast	2
3-2	SPM	R/W	Burst PLL control. 0 = Slowest 1 = Slow 2 = Fast 3 = Fastest	1
1-0	CBW	R/W	Chroma low pass filter bandwidth control. Refer to filter curves.	1

0x2F – Miscellaneous Control II (MISC2)

Bit	Function	R/W	Description	Reset
7	NKILL	R/W	1 = Enable noisy signal color killer function in NTSC mode. 0 = Disabled.	1
6	PKILL	R/W	1 = Enable automatic noisy color killer function in PAL mode. 0 = Disabled.	1
5	SKILL	R/W	1 = Enable automatic noisy color killer function in SECAM mode. 0 = Disabled.	1
4	CBAL	R/W	0 = Normal output 1 = special output mode.	0
3	FCS	R/W	1 = Force decoder output value determined by CCS. 0 = Disabled.	0
2	LCS	R/W	1 = Enable pre-determined output value indicated by CCS when video loss is detected. 0 = Disabled.	0
1	CCS	R/W	When FCS is set high or video loss condition is detected when LCS is set high, one of two colors display can be selected. 1 = Blue color. 0 = Black.	0
0	BST	R/W	1 = Enable blue stretch. 0 = Disabled.	0

0x30 – Macrovision Detection (MVSN)

Bit	Function	R/W	Description	Reset
7	SF	R		0
6	PF	R		0
5	FF	R		0
4	KF	R		0
3	CSBAD	R	Set when Macrovision color stripe detection may be un-reliable	0
2	MCVSN	R	1 = Macrovision AGC pulse detected. 0 = Not detected.	0
1	CSTRIPE	R	1 = Macrovision color stripe protection burst detected. 0 = Not detected.	0
0	CTYPE	R	This bit is valid only when color stripe protection is detected, i.e. Cstripe=1. 1 = Type 2 color stripe protection 0 = Type 3 color stripe protection	0

0x31 – Chip STATUS II (STATUS2)

Bit	Function	R/W	Description	Reset
7	VCR	R	VCR signal indicator	0
6	WKAIR	R	Weak signal indicator 2.	0
5	WKAIR1	R	weak signal indicator controlled by WKTH.	0
4	VSTD	R	1 = 525/625 line signal 0 = Non-standard signal	0
3	NINTL	R	1 = Non-interlaced signal 0 = interlaced signal	0
2	WSSDET	R	1 = WSS data detected. 0 = Not detected.	0
1	EDSDET	R	1 = EDS data detected. 0 = Not detected.	0
0	CCDET	R	1 = CC data detected. 0 = Not detected.	0

0x32 – H monitor (HFREF)

Bit	Function	R/W	Description	Reset
7-0	HFREF	R	Horizontal line frequency indicator	X

0x33 – CLAMP MODE (CLMD)

Bit	Function	R/W	Description	Reset
7-6	FRM	R/W	Free run mode control 0 = Auto 2 = default to 60Hz 3 = default to 50Hz	0
5-4	YNR	R/W	Y HF noise reduction 0 = None 1 = smallest 2 = small 3 = medium	0
3-2	CLMD	R/W	Clamping mode control. 0 = Sync top 1 = Auto 2 = Pedestal 3 = N/A	1
1-0	PSP	R/W	Slice level control 0 = low 1 = medium 2 = high	1

0x34 – ID Detection Control (IDCNTL)

Bit	Function	R/W	Description	Reset
7-6	IDX	R/W	These two bits indicate which of the four lower 6-bit registers is currently be controlled. The write sequence is a two steps process unless the same register is written. A write of {ID,000000} selects one of the four registers to be written. A subsequent write will actually write into the register.	0
5-0	NSEN / SSEN / PSEN / WKTH	R/W	IDX = 0 controls the NTSC ID detection sensitivity (NSSEN). IDX = 1 controls the SECAM ID detection sensitivity (SSEN). IDX = 2 controls the PAL ID detection sensitivity (PSEN). IDX = 3 controls the weak signal detection sensitivity (WKTH).	1A / 20 / 1C / 11

0x35 – Clamp Control I (CLCNTL1)

Bit	Function	R/W	Description	Reset
7	CTEST	R/W	Clamping control for debugging use.	0
6	YCLEN	R/W	1 = Y channel clamp disabled 0 = Enabled.	0
5	CCLLEN	R/W	1 = C channel clamp disabled 0 = Enabled.	0
4	VCLEN	R/W	Reserved	0
3	GTEST	R/W	1 = Test. 0 = Normal operation.	0
2	VLPF	R/W	Sync filter control	0
1	CKLY	R/W	Clamping current control 1.	0
0	CKLC	R/W	Clamping current control 2.	0

0x4F – WSS3

Bit	Function	R/W	Description	Reset
7-0	WSS[19:14]	R	CGMS(WSS525) Bit19-14 in 525 line video system. These bits show CRC 6bits in CGMS(WSS525). These bits are only valid in 525 line video system.	X

0x50 – FILLDATA

Bit	Function	R/W	Description	Reset
7-0	FILLDATA	R/W	Filled data as dummy data in ANC Dword data packet.	A0

0x51 – SDID

Bit	Function	R/W	Description	Reset
7	NODAEN	R/W	1:Bit7 in 4 th byte of EAV/SAV code will be 0 when sync lost(No Video input.) 0: Bit7 in 4 th byte of EAV/SAV is always VIPCFG register bit.	0
6	SYRM	R/W	1: Minimum value in raw VBI will be 0x10 for Sync Level remove. 0:none.	0
5-0	SDID	R/W	Secondary data ID in ANC data packet type 2	22

0x52 – DID

Bit	Function	R/W	Description	Reset
7	ANCEN	R/W	ANC data packet output control. 1 = enable. 0:disable.	0
6	TOUTH	R/W	1: reserved 0:should be "0" in normal mode.	0
5	VIPCFG	R/W	Set up Bit7 in 4 th byte of EAV/SAV code.	1
4-0	DID	R/W	Data ID in ANC data packet type 2.	11

0x53 – WSS1

Bit	Function	R/W	Description	Reset
7	CRCERR	R	This bit is only valid in 525 line video system. 1: CGMS(WSS525) CRC error detected in current field. 0:No CRC error	X
6	WSSFLD	R	0:current WSS data is received in Odd field. 1: current WSS data is received in Even field.	X
5-0	WSS[13:8]	R	CGMS(WSS525) Bit13-8 in 525 line video system. Wide Screen Signaling Bit13-8 in 625 line video system.	X

0x54 – WSS2

Bit	Function	R/W	Description	Reset
7-0	WSS[7:8]	R	CGMS(WSS525) Bit7-0 in 525 line video system. Wide Screen Signaling Bit7-0 in 625 line video system.	X

0x55 – VVBI

Bit	Function	R/W	Description	Reset
7	HA656	R/W	1:HACTIVE signal is same as DVALID signal in H Down scaled video output. 0:HACTIVE signal is always HACTIVE register's length.	0
6	EAVSWAP	R/W	1:EAV-SAV code is swapped. 0:EAV-SAV code is not swapped(standard 656 output mode)	0
5	HAMM84	R/W	1:enable 84 Hamming Code checking BI Slicer.0: disable.	0
4	NTSC656	R/W	1: Number of Even Field Video output line is (the number of Odd field Video output line – 1). This bit is required for ITU-R BT.656 output for 525-line system standard. 0: Number of Even Field Video output line is same as the number of Odd field Video output line.	0
3-0	VVBI	R/W	The number of raw VBI data output line counted from top video active line signal timing.	0

0x56~6A LCTL6~LCTL26

Bit	Function	R/W	Description	Reset
7-4	LCTLn	R/W	Set up VBI Data Slicer Decoding mode on Line-n. Value is set up by upper bit7-4 meaning for Line-n in odd field.	0
3-0		R/W	Value is set up by below bit3-0 meaning for Line-n in even field. 0h:disable decoding. 1h:Teletext-B 2h:Teletext-C 3h:Teletext-D 4h:Closed Captioning and Extended Data service. (EIA-608 type). 5h:CGMS (WSS525) in 525 line system or WSS625 in 625 line system. 6h:VITC 7h:Gemstar 1x 8h:Gemstar 2x 9h:VPS (Line16 VPS type) Ah: Teletext-A Bh~Fh: reserved	0

0x6B – HSGEGIN

Bit	Function	R/W	Description	Reset
7-0	HSBEGIN	R/W	HSYNC Start position.	2C

0x6C – HSEND

Bit	Function	R/W	Description	Reset
7-0	HSEND	R/W	HSYNC End position.	60

0x6D – OVSDLY

Bit	Function	R/W	Description	Reset
7-0	OVSDLY	R/W	VSYNC Start position.	00

0x6E – OVSEND

Bit	Function	R/W	Description	Reset
7	HSPIN	R/W	1:HSYNC output is HACTIVE. 0:HSYNC output is HSYNC.	0
6-4	OFDLY	R/W	FIELD output delay. 0h:0H line delay FIELD output. (601 mode only) 1h-6h: 1-H to 6-H line delay FIELD output. 7h:FIELD output is synchronized to the leading edge of VACTIVE.	2
3	VSMODE	R/W	1:VSYNC output is HACTIVE-VSYNC mode. 0:VSYNC output is HSYNC-VSYNC mode.	0
2-0	OVSEND	R/W	Line delay for VSYNC end position.	0

0x6F – VBIDELAY

Bit	Function	R/W	Description	Reset
7	PDNSVBI	R/W	1:VBI data slicer enable 0: VBI data slicer is in reset and power-down mode	0
6	Reserved	R/W		0
5-0	VBIDELAY	R/W	Raw VBI output delay	24

Pin Diagram

44 PIN LQFP

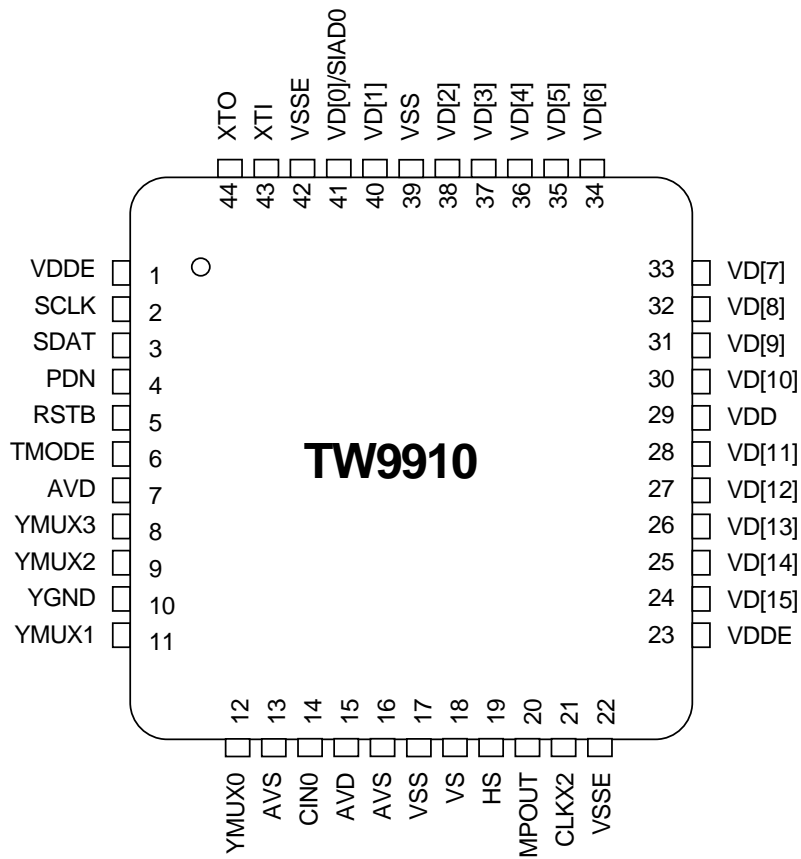

Pin Diagram

48 PIN QFN

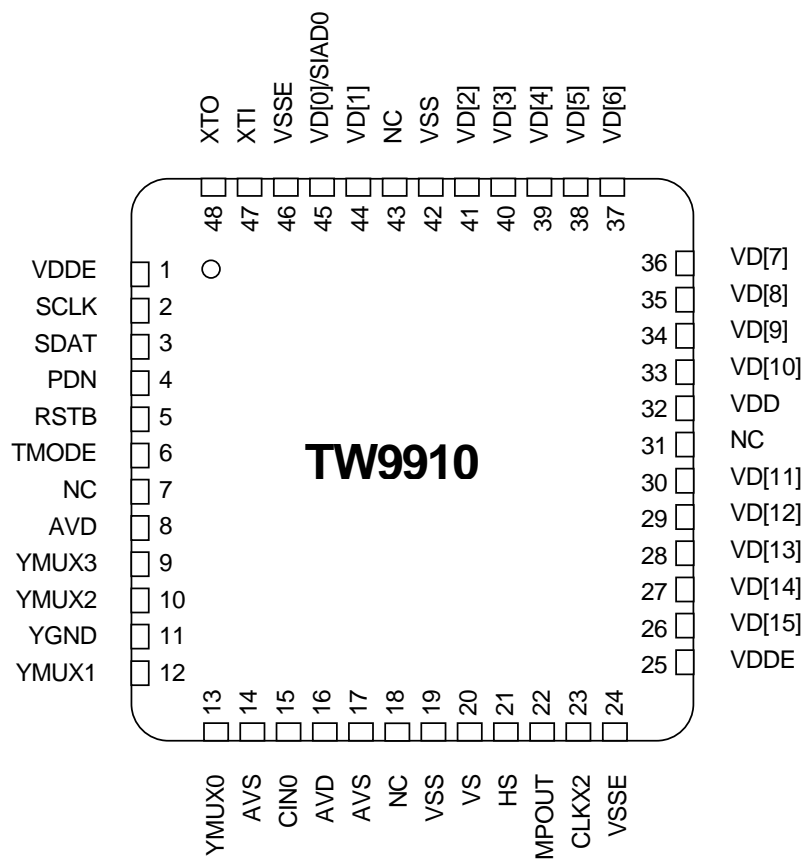

Pin Description

Pin#		I/O	Pin Name	Description
LQFP	QFN			
Analog video signals				
12	13	I	MUX0	Analog CVBS or Y input. Connect unused input to AGND through 0.1uF capacitor.
11	12	I	MUX1	Analog CVBS or Y input. Connect unused input to AGND through 0.1uF capacitor.
9	10	I	MUX2	Analog CVBS or Y input. Connect unused input to AGND through 0.1uF capacitor.
8	9	I	MUX3	Analog CVBS or Y input. Connect unused input to AGND through 0.1uF capacitor.
10	11		YGND	Analog Differential input for Y-ADC.
14	15	I	CIN0	Analog chroma input. Connect unused input to AGND through 0.1uF capacitor.
Clock Signals				
43	47	I	XTI	Clock input. A 27Mhz fundamental (or 3 rd overtone) crystal or a single-ended oscillator can be connected.
44	48	O	XTO	Clock output. For connecting a crystal.
Host Interface				
2	2	I	SCLK	The MPU Serial interface Clock Line.
3	3	I/O	SDAT	The MPU Serial interface Data Line.
General signals				
5	5	I	RSTB	Reset input. Low active.
4	4	I	PDN	Power down control pin. It is high active.
6	6	I	TMODE	Test pin. It should be low for normal operation.
	7,18, 31,43		NC	NC pin.
Video output Signals				
19	21	O	HS	Horizontal sync and multi-purpose output pin. See register for control information.
18	20	O	VS	Vertical Sync and multi-purpose output. See register for control information.
21	23	O	CLK2	Data Clock output. See register for control information.
20	22	O	MPOUT	Multi-purpose output pin. The output function can be selected by RTSEL of register 0x19
24,25, 26,27, 28,30, 31,32	26,27, 28,29, 30,33, 34,35	O	VD[15:8]	Digitized Video Data Outputs of Y/YCbCr. VD[8] is the LSB and VD[15] is the MSB.
33,34, 35,36, 37,38, 40	36,37, 38,39, 40,41, 44	I/O	VD[7:1]	Digitized video data output of CbCr. VD[7] is the MSB.
41	45	I/O	VD[0]/ SIAD0	LSB of digitized video data output of CbCr. SIAD0 : The MPU interface address select pin 0. A pullup or pulldown resistor is needed for select one of the two addresses that chip will respond.

Power and Ground Pins

Pin#		I/O	Pin Name	Description
29	32	I	VDD	1.8V digital core power.
17,39	19,42	I	VSS	1.8V digital core return
1,23	1,25	I	VDDE	3.3V digital I/O power.
22,42	24,46	I	VSSE	3.3V digital I/O return
7,15	8,16	I	AVD	1.8V analog ADC supply
13,16	14,17	I	AVS	1.8V analog ADC return

Parametric Information

AC/DC Electrical Parameters

Table 21. Absolute Maximum Ratings

Parameter	Symbol	Min	Typ	Max	Units
AVD (measured to AVS)	VDDAM	-	-	2.0	V
V _{DD} (measured to VSS)	VDDM		-	2.0	V
V _{DDE} (measured to VSSE)	VDDEM		-	3.6	V
Voltage on any signal pin (See the note below)	-	VSSE - 0.5	-	VDDEM + 0.5	V
Analog Input Voltage	-	AVS - 0.5	-	VDDAM + 0.5	V
Storage Temperature	T _S	-65	-	+150	°C
Junction Temperature	T _J	-	-	+125	°C
Vapor Phase Soldering(15 Seconds)	T _{VSOL}	-	-	+220	°C

NOTE: Stresses above those listed may cause permanent damage to the device. This is a stress rating only, and functional operation at these or any other conditions above those listed in the operational section of this specification is not implied. Exposure to absolute maximum rating conditions for extended periods may affect device reliability.

This device employs high-impedance CMOS devices on all signal pins. It must be handled as an ESD-sensitive device. Voltage on any signal pin that exceeds the power supply voltage by more than +0.5 V or drops below ground by more than 0.5 V can induce destructive latch-up.

Table 22. characteristics

Parameter	Symbol	Min	Typ	Max	Units
Supply					
Power Supply — IO	V _{DDE}	3.15	3.3	3.6	V
Power Supply — Analog	V _{DDA}	1.6	1.8	2.0	V
Power Supply — Digital	V _{DD}	1.6	1.8	2.0	V
Maximum V _{DD} - AVDD		-	-	0.3	V
MUX0, MUX1, MUX2 and MUX3 Input Range (AC coupling required)		0.5	1.00	1.40	V
CIN0 Amplitude Range (AC coupling required)		0.5	1.00	1.40	V
Ambient Operating Temperature	T _A	0		+70	°C
Analog Supply current : CVBS S-video	I _{aa}	-	12	-	mA
		-	20	-	mA
Digital I/O Supply current	I _{dde}	-	9	-	mA
Digital Core Supply Current	I _{dd}	-	24	-	mA
Digital Inputs					
Input High Voltage (TTL)	V _{IH}	2.0	-	V _{DDE} + 0.5	V
Input Low Voltage (TTL)	V _{IL}	-	-	0.8	V
Input High Voltage (XTI)	V _{IH}	2.0	-	V _{DDE} + 0.5	V
Input Low Voltage (XTI)	V _{IL}	VSS - 0.5	-	1.0	V

Input High Current ($V_{IN}=V_{DD}$)	I_{IH}	-	-	10	μA
Input Low Current ($V_{IN}=V_{SS}$)	I_{IL}	-	-	-10	μA
Input Capacitance ($f=1$ MHz, $V_{IN}=2.4$ V)	C_{IN}	-	5	-	pF

Parameter	Symbol	Min	Typ	Max	Units
Digital Outputs					
Output High Voltage ($I_{OH} = -2$ mA)	V_{OH}	2.4	-	V_{DDE}	V
Output Low Voltage ($I_{OL} = 2$ mA)	V_{OL}	-	0.2	0.4	V
3-State Current	I_{OZ}	-	-	10	μA
Output Capacitance	C_O	-	5	-	pF
Analog Input					
Analog Pin Input voltage	V_i	-	1	-	Vpp
Analog Pin Input Capacitance	C_A	-	7	-	pF
ADCs					
ADC resolution	ADCR	-	10	-	bits
ADC integral Non-linearity	AINL	-	± 1	-	LSB
ADC differential non-linearity	ADNL	-	± 1	-	LSB
ADC clock rate	f_{ADC}	24	27	30	MHz
Video bandwidth (-3db)	BW	-	10	-	MHz
Horizontal PLL					
Line frequency (50Hz)	f_{LN}	-	15.625	-	KHz
Line frequency (60Hz)	f_{LN}	-	15.734	-	KHz
static deviation	Δf_H	-	-	6.2	%
Subcarrier PLL					
subcarrier frequency (NTSC-M)	f_{SC}	-	3579545	-	Hz
subcarrier frequency (PAL-BDGI)	f_{SC}	-	4433619	-	Hz
subcarrier frequency (PAL-M)	f_{SC}	-	3575612	-	Hz
subcarrier frequency (PAL-N)	f_{SC}	-	3582056	-	Hz
lock in range	Δf_H	± 450	-	-	Hz
Crystal spec					
nominal frequency (fundamental)		-	27	-	MHz
deviation		-	-	± 50	ppm
Temperature range	T_a	0	-	70	$^{\circ}C$
load capacitance	CL	-	20	-	pF
series resistor	RS	-	80	-	Ohm
Oscillator Input					
nominal frequency		-	27	-	MHz
deviation		-	-	± 50	ppm
duty cycle		-	-	55	%

Parameter	Symbol	Min	Typ	Max	Units
Output CLK					
CLKX1		12	13.5	15	MHz
CLKX2		24	27	30	MHz
CLKX1 Duty Cycle		-	-	55	%
CLKX2 Duty Cycle		-	-	55	%
CLKX2 to CLKX1 Delay	4	-	-	2	ns
CLKX1 to Data Delay	5	-	5	-	ns
CLKX2 to Data Delay	6	-	5	-	ns
CLKX1 (Falling Edge) to VCLK (Rising Edge)	41	-	0	-	ns
CLKX2 (Falling Edge) to VCLK (Rising Edge)	42	-	0	-	ns
Output Video Data					
8-bit Mode (1)					
Data to VCLK (Rising Edge) Delay	7b	-	18	-	ns
VCLK (Rising Edge) to Data Delay	8b	-	18	-	ns
16-bit Mode (1)					
Data to VCLK (Rising Edge) Delay	7a	-	37	-	ns
VCLK (Rising Edge) to Data Delay	8a	-	37	-	ns

Clock Timing Diagram

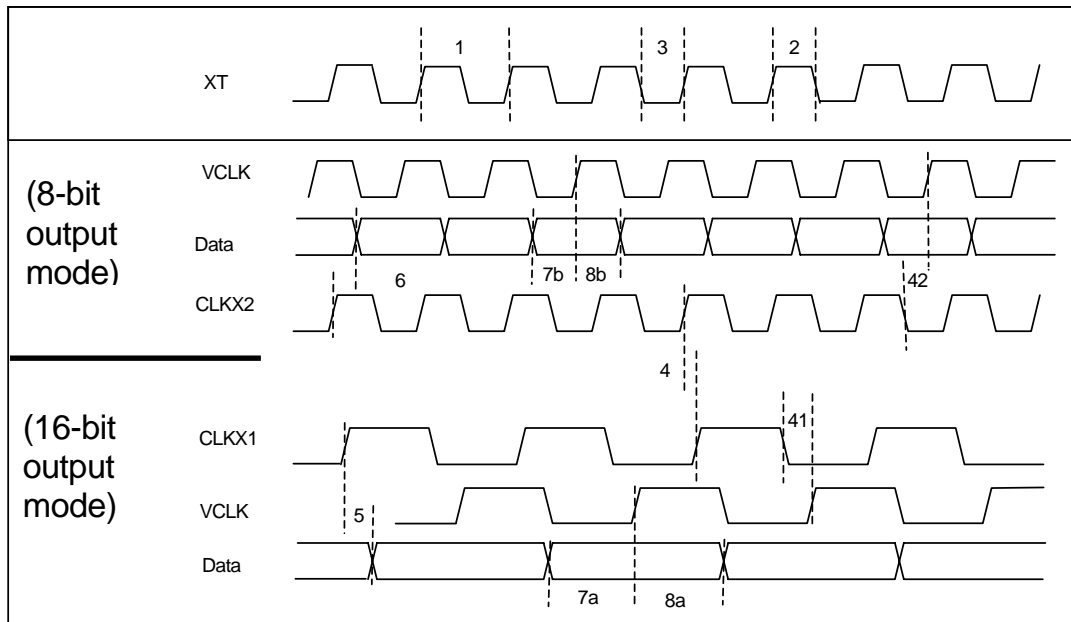

Mechanical Data

44 Pin LQFP

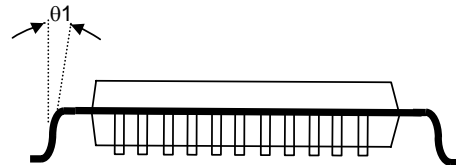
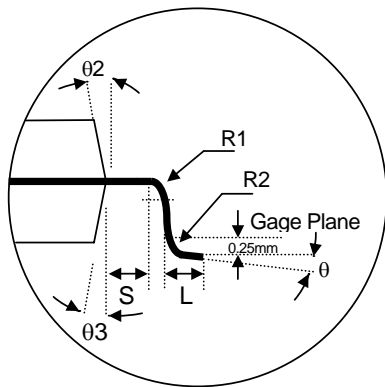
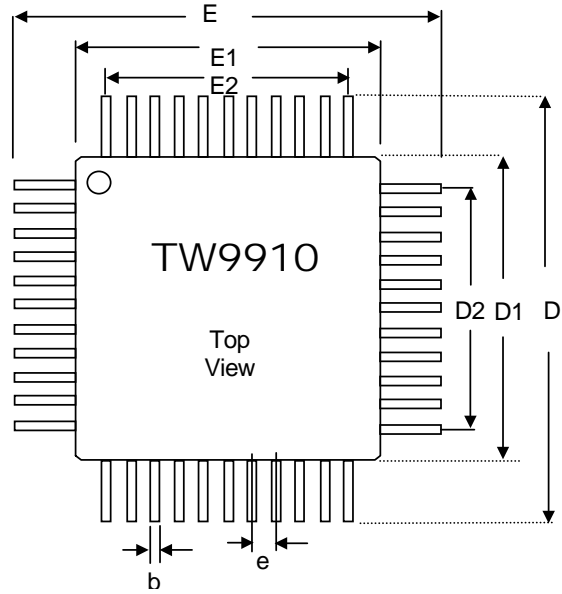
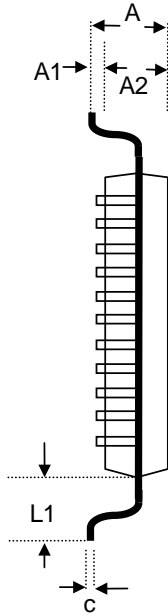

SYMBOL	MILLIMETER			INCH		
	MIN	NOM	MAX	MIN	NOM	MAX
A	---	---	1.60	---	---	0.063
A1	0.05	---	0.15	0.002	---	0.006
A2	1.35	1.40	1.45	0.053	0.055	0.057
D	9.00 BSC.			0.354 BSC.		
D1	7.00 BSC.			0.276 BSC.		
E	9.00 BSC.			0.354 BSC.		
E1	7.00 BSC.			0.276 BSC.		
R2	0.08	---	0.20	0.003	---	0.008
R1	0.08	---	---	0.003	---	---
θ	0°	3.5°	7°	0°	3.5°	7°
θ_1	0°	---	---	0°	---	---
θ_2	11°	12°	13°	11°	12°	13°
θ_3	11°	12°	13°	11°	12°	13°
c	0.09	---	0.20	0.004	---	0.008
L	0.45	0.60	0.75	0.018	0.024	0.030
L1	1.00 REF			0.039 REF		
S	0.20	---	---	0.008	---	---
b	0.17	0.20	0.27	0.007	0.008	0.011
e	0.50 BSC.			0.020 BSC.		
D2	5.00			0.197		
E2	5.00			0.197		

NOTES:

- Dimensions D1 and E1 do not include mold protrusion. Allowable protrusion is 0.25mm per side. D1 and E1 are maximum plastic body size dimensions including mold mismatch.
- Dimension b does not include dambar protrusion. Allowable dambar protrusion shall not cause the lead width to exceed the maximum b dimension by more than 0.08mm. Dambar can not be located on the lower radius or the foot. Minimum space between protrusion and a adjacent lead is 0.07mm for 0.4mm and 0.5mm pitch packages.

SYMBOL	MILLIMETER			INCH		
	MIN	NOM	MAX	MIN	NOM	MAX
A	---	---	0.90	---	---	0.035
A1	0.00	0.01	0.05	0.00	0.0004	0.002
A2	---	0.65	0.70	---	0.026	0.028
A3	0.2 REF.			0.008 REF.		
b	0.20	0.25	0.32	0.008	0.010	0.013
D	7.00 BSC.			0.276 BSC.		
D1	6.75 BSC.			0.266 BSC.		
D2	5.00	5.20	5.40	0.197	0.205	0.213
E	7.00 BSC.			0.276 BSC.		
E1	6.75 BSC.			0.266 BSC.		
E2	5.00	5.20	5.40	0.197	0.205	0.213
L	0.30	0.40	0.50	0.012	0.016	0.020
e	0.50 BSC.			0.020 BSC.		
θ1	0°	---	12°	0°	---	12°
R	0.09	---	---	0.004	---	---
TOLERANCES OF FORM AND POSITION						
aaa	0.10			0.004		
bbb	0.10			0.004		
ccc	0.05			0.002		

* CONTROLLING DIMENSION : MM

NOTES:

1. All dimensions are in millimeters.
2. Dimension applies to plated terminal and is measured between 0.20 and 0.25mm from terminal tip.
3. Package warpage MAX 0.08mm.
4. Package corners unless otherwise specified are R0.175± 0.025mm

Application Schematics

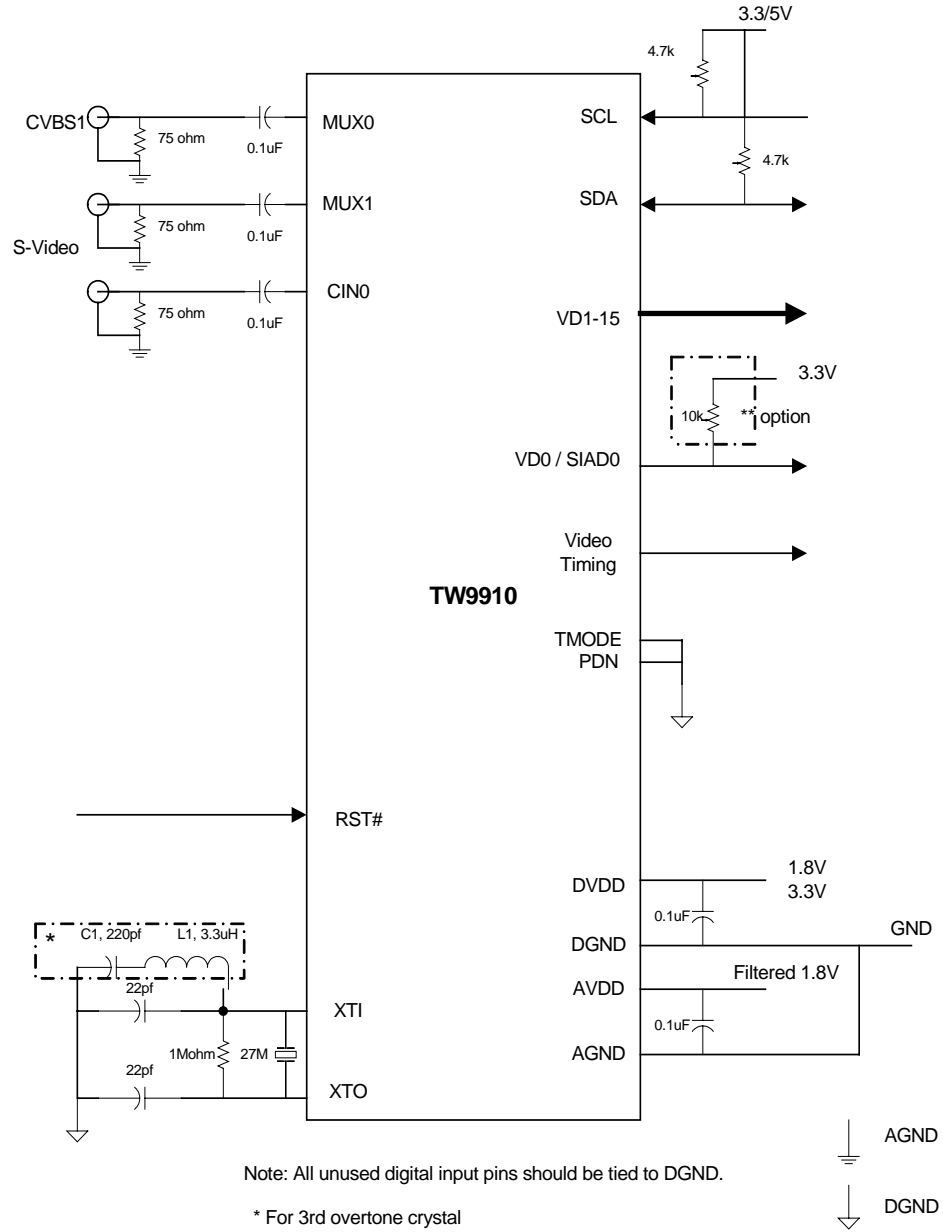

Typical TW9910 External Circuitry

PCB Layout Considerations

The PCB layout should be done to minimize the power and ground noise on the TW9910. This is done by good power de-coupling with minimum lead length on the de-coupling capacitors; well-filtered and regulated analog power input shielding and ground plane isolation.

The ground plane should cover most of the PCB area with separated digital and analog ground planes surrounding the chip. These two planes should be at the same electrical potential and connected together under TW9910. The following figure shows a ground plane layout example.

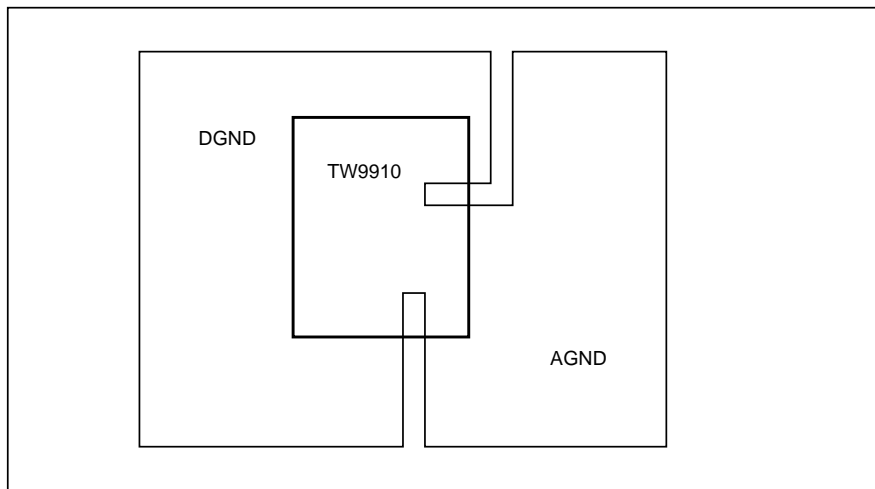

To minimize crosstalk, the digital signals of TW9910 should be separated from the analog circuitry. Moreover, the digital signals should not cross over the analog power and ground plane. Parallel running of digital lines for long distance should also be avoided.

For QFN Package, the Exposed die pad (Ground bond) can be either floating or soldered to PCB Ground to enhance thermal performance.

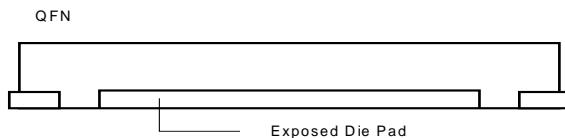

Copyright Notice

This manual is copyrighted by Techwell, Inc. Do not reproduce, transform to any other format, or send/transmit any part of this documentation without the express written permission of Techwell, Inc.

Disclaimer

This document provides technical information for the user. Techwell, Inc. reserves the right to modify the information in this document as necessary. The customer should make sure that they have the most recent data sheet version. Techwell, Inc. holds no responsibility for any errors that may appear in this document. Customers should take appropriate action to ensure their use of the products does not infringe upon any patents. Techwell, Inc. respects valid patent rights of third parties and does not infringe upon or assist others to infringe upon such rights.

Life Support Policy

Techwell, Inc. products are not authorized for use as critical components in life support devices or systems.

Datasheet revision history

Date	
12/14/2005	First draft.
12/27/2005	Add MPOUT pin description. Change Oscillator Input deviation +/-25 to +/- 50
01/24/2006	Add LQFP.
02/20/2006	Pg61, Fix pin number, LQFP pin17 to pin16. Pg27 Reg. Table 0x1E. Pg28 Reg. Table 0x4F.
03/08/2006	Pg62, change symbols. AVD, AVS. Pg27. Reg 0x16, reset:00.
09/21/2006	P70, add exposed die pad info.