

Equalizer and ATF circuit IC for Digital VCRs

BH7273KV

The BH7273KV is an equalizer and ATF circuit IC developed for use with digital video cassettes (DVC). By using this IC, it is simple to design the filter for the equalizer required for DVD sets. In addition, the ATF circuit detects the pilot signals and generates error signals.

●Applications

Equalizers and ATFs for digital VCRs

●Features

- 1) Enables the configuring of all pass filters, 1 + D circuits, and transversal filters (TVF).
- 2) Built-in VCA, amplifier, buffer, and mixer amplifier.
- 3) Detects the ATF pilot signal and generates an ATF error signal.
- 4) Built-in 1.5MHz LPF, VCA, 465kHz BPF, 697.5kHz BPF, 25dB amplifier, peak detector, and subtractor.
- 5) Intermediate frequencies are variable by controlling the voltages for the 465kHz BPF and 697.5kHz BPF.

●Absolute maximum ratings (Ta = 25°C)

Parameter	Symbol	Limits	Unit
Applied voltage	V _{cc}	7.0	V
Power dissipation	P _d	* 1000	mW
Operating temperature	T _{opr}	- 20 ~ + 65	°C
Storage temperature	T _{stg}	- 55 ~ + 125	°C

* When mounted on a 70mm × 70mm × 1.6mm glass epoxy board.

* Reduced by 10.0mW for each increase in Ta of 1°C over 25°C.

●Recommended operating conditions (Ta = 25°C)

Parameter	Symbol	Min.	Typ.	Max.	Unit	Conditions
Power supply voltage	V _{cc} 5V	4.6	4.9	5.2	V	2, 15, 21, 33, 44, 48, 60pin

○Not designed for radiation resistance.

●Block diagram

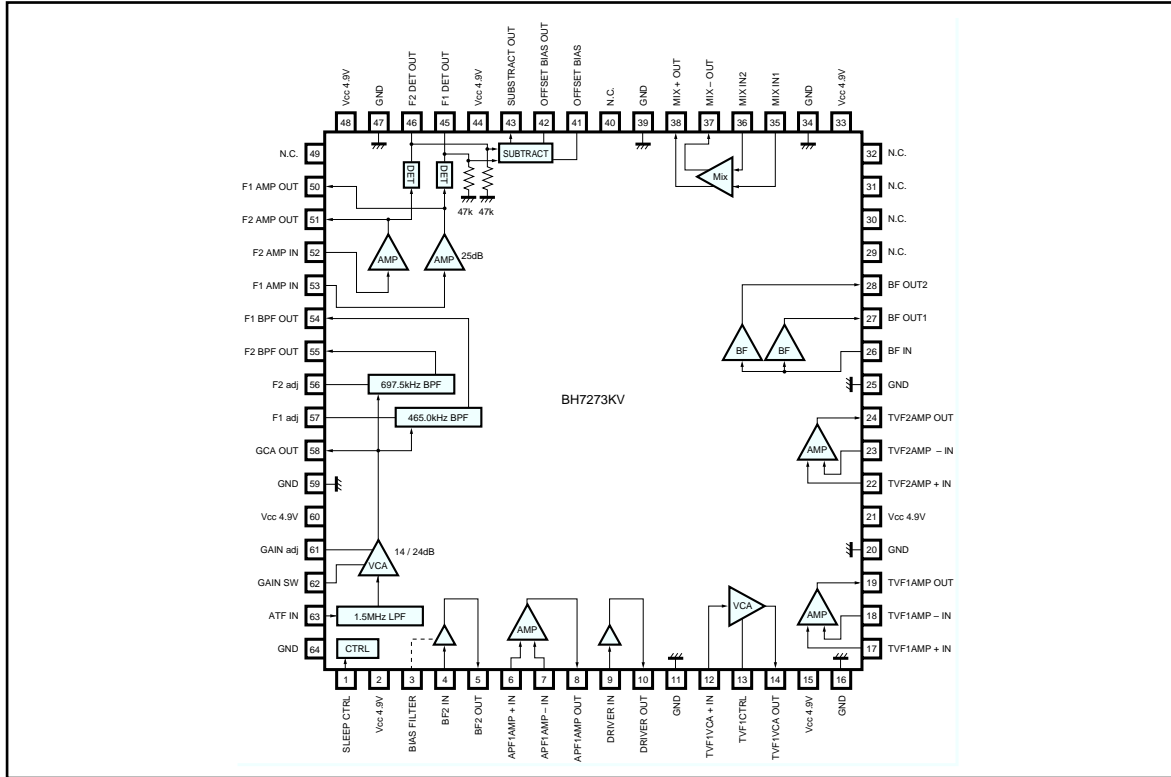

●Vcc-GND pin table

Pin No.	Pin name	Function
2 11	Vcc 4.9V GND	All pass filter for pins 3 to 10 Same as above
15 16	Vcc 4.9V GND	12-14pin VCA, 17-19pin AMP Same as above
21 20 25	Vcc 4.9V GND GND	22-24pin AMP, 26-28pin BUFF 22-24pin AMP 26-28pin BUFF
33 34	Vcc 4.9V GND	35-38pin MIX AMP 35-38pin MIX AMP
44 39	Vcc 4.9V GND	Detector, subtractor circuit Same as above
48 47	Vcc 4.9V GND	BPF, 25dBAMP Same as above
60 59	Vcc 4.9V GND	LPF, GCA Same as above
64	GND	N.C. (Connected to GND to lower impedance)

- * Make sure that Vcc and GND do not sway.
- * Separate the equalizer and ATF grounds.
- * Since the gain of the ATF circuit is high, make sure that there is no return from the output to input.

●Electrical characteristics (unless otherwise noted, Ta = 25°C, V_{CC} = 4.9V, f = 4.0MHz)

Parameter	Symbol	Min.	Typ.	Max.	Unit	Conditions
Quiescent current	I _q	—	63	100	mA	No signal
Quiescent current	I _{q(S)}	—	16	30	mA	No signal, sleep mode
[Equalizer block]						
(All pass filter)						
Voltage gain	G _{VA}	- 3.0	± 0.0	+ 3.0	dB	Input at pin 4 = 300mV _{P-P} Measure output at pin 10
Frequency characteristics	ΔG _{VA}	- 3.0	± 0.0	—	dB	f = 8.0 / 1.0MHz, V _{IN} = 300mV _{P-P} Output level difference for pin 10
(VCA)						
Voltage gain	G _{VV1}	- 1.0	2.0	—	dB	Input at pin 12 = 150mV _{P-P} , pin 13 = 3.0V Measure output at pin 14
Voltage gain	G _{VV2}	—	- 28.0	- 12.0	dB	Input at pin 12 = 150mV _{P-P} , pin 13 = 0.25V Measure output at pin 14
Frequency characteristics	ΔG _{VV}	- 3.0	± 0.0	—	dB	f = 8.0 / 1.0MHz, V _{IN} = 150mV _{P-P} Output level difference for pin 14; pin 13 = 3.0V
(TVF AMP)						
Voltage gain	G _{VT}	3.9	6.9	9.9	dB	Input at pins 17, 18, 22, and 23 = 150mV _{P-P} Measure output at pins 19 and 24
Frequency characteristics	ΔG _{VT}	- 3.0	± 0.0	—	dB	f = 8.0 / 1.0MHz, V _{IN} = 150mV _{P-P} Output level difference for pins 19 and 24
(BUFF AMP)						
Voltage gain	G _{VB}	- 4.2	- 1.2	—	dB	Input at pin 26 = 300mV _{P-P} Measure output at pins 27 and 28
Frequency characteristics	ΔG _{VB}	- 3.0	± 0.0	—	dB	f = 8.0 / 1.0MHz, V _{IN} = 300mV _{P-P} Output level difference for pins 27 and 28
(MIX AMP)						
Voltage gain	G _{VM}	5.0	8.0	11.0	dB	Input at pins 35 and 36 = 150mV _{P-P} Measure output at pins 37 and 38
Frequency characteristics	ΔG _{VM}	- 3.0	0.0	—	dB	f = 8.0 / 1.0MHz, V _{IN} = 150mV _{P-P} Output level difference for pins 37 and 38
[ATF block]						
VCA voltage gain 1	G _{VF1}	11	14	17	dB	Input at pin 63 = 2.0mV _{P-P} , pin 62 = low Measure output at pin 58, f = 697.5kHz
VCA voltage gain 2	G _{VF2}	21	24	27	dB	Input at pin 63 = 2.0mV _{P-P} , pin 62 = high Measure output at pin 58, f = 697.5kHz
465.0kHz BPF voltage gain	G _{VB1}	44	48	52	dB	Input at pin 63 = 0.3mV _{P-P} , pin 62 = high Measure output at pin 50, f = 465.0kHz
697.5kHz BPF voltage gain	G _{VB2}	44	48	52	dB	Input at pin 63 = 0.3mV _{P-P} , pin 62 = high Measure output at pin 51, f = 697.5kHz
ATF OUT output level 1	V _{ATF1}	1.30	1.50	1.70	V	No signal
ATF OUT output level 2	V _{ATF2}	1.50	1.80	2.10	V	50pin = 100mV _{P-P} 51pin = 300mV _{P-P} , 41pin = 1.5V
ATF OUT output level 3	V _{ATF3}	0.60	0.90	1.20	V	50pin = 500mV _{P-P} 51pin = 100mV _{P-P} , 41pin = 1.5V
[Logic block]						
SLEEP hold voltage	V _{TH1H}	2.0	—	4.9	V	Pin 1 voltage for SLEEP mode
SLEEP hold voltage	V _{TH1L}	0.0	—	1.0	V	Pin 1 voltage for $\overline{\text{SLEEP}}$ mode
VCA gain switch low	V _{TH62L}	0.0	—	1.0	V	Pin 62 voltage for ATF VCA gain to be low
VCA gain switch high	V _{TH62H}	2.0	—	4.9	V	Pin 62 voltage for ATF VCA gain to be high

●Input / output circuits

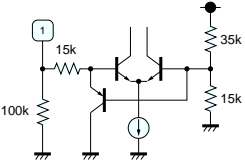
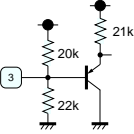
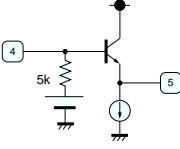
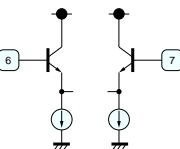
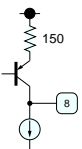
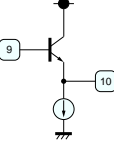
Pin No.	Pin name	Pin voltage	Internal circuit	Function
1	SLEEP CTRL	0.0		Sleep control
2	Vcc 5V	—	—	Vcc for all pass filter of pins 3 to 10
3	BIAS FILTER	2.2		Filter for BF amplifier bias of pins 4 and 5
4 5	BF2 IN BF2 OUT	3.0 2.2		Buffer amplifier input Buffer amplifier output
6 7	APF1 AMP + IN APF1 AMP - IN	— —		APF amplifier positive input APF amplifier negative input
8	APF1 AMP OUT	—		APF amplifier output
9 10	DRIVER IN DRIVER OUT	— —		Driver input Driver output

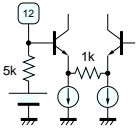
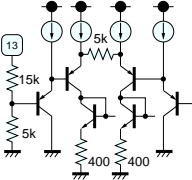
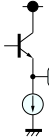
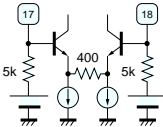
Pin No.	Pin name	Pin voltage	Internal circuit	Function
11	GND	—	—	GND for all pass filter of pins 3 to 10
12	TVF1 VCA + IN	2.2		TVF1 VCA positive input
13	TVF1 CTRL	0.0		TVF1 VCA gain control
14	TVF1 VCA OUT	1.7		TVF1 VCA positive output
15	Vcc 5V	—	—	Vcc for VCA of pins 12 to 14 and for amplifier of pins 17 to 19
16	GND	—	—	GND for VCA of pins 12 to 14 and for amplifier of pins 17 to 19
17 18	TVF1 AMP + IN TVF1 AMP - IN	2.2 2.2		TVF1 amplifier positive input TVF1 amplifier negative input

Pin No.	Pin name	Pin voltage	Internal circuit	Function
19	TVF1 AMP OUT	2.7		TVF1 amplifier output
20	GND	—	—	GND for amplifier of pins 22 to 24
21	V _{cc} 5V	—	—	V _{cc} for amplifier of pins 22 to 24 and for BF of pins 26 to 28
22 23	TVF2 AMP + IN TVF2 AMP - IN	2.2 2.2		TVF2 amplifier positive input TVF2 amplifier negative input
24	TVF2 AMP OUT	2.7		TVF2 amplifier output
25	GND	—	—	GND for BF of pins 26 to 28
26 27 28	BF IN BF OUT1 BF OUT2	2.1 1.3 1.3		BF input BF output 1 BF output 2

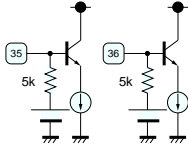
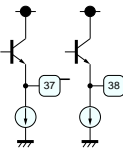
Pin No.	Pin name	Pin voltage	Internal circuit	Function
29 30 31 32	N.C.	—	—	—
33	V _{cc} 5V	—	—	V _{cc} for VCA of pins 30 to 32 and MIX amplifier of pins 35 to 38
34	GND	—	—	GND for MIX amplifier of pins 35 to 38
35 36	MIX IN1 MIX IN2	2.2 2.2		MIX amplifier input 1 MIX amplifier input 2
37 38	MIX – OUT MIX + OUT	3.2 3.2		MIX amplifier output 1 MIX amplifier output 2
39	GND	—	—	GND for detector, subtractor, and reverse polarity circuits
40	N.C.	—	—	—

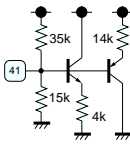
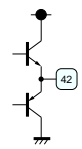
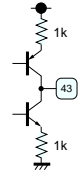
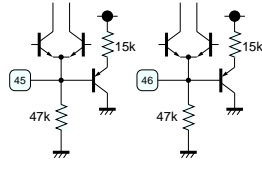
Pin No.	Pin name	Pin voltage	Internal circuit	Function
41	OFFSET BIAS	1.5		Bias adjustment
42	OFFSET BIAS OUT	2.5		Bias output
43	SUBTRACT OUT	—		ATF output
44	V _{cc} 5V	—	—	V _{cc} for detector, subtractor, and reverse polarity circuits
45 46	F1DET OUT F2DET OUT	— —		F1 detector F2 detector
47	GND	—	—	GND for BPF and 25dB amplifier
48	V _{cc} 5V	—	—	V _{cc} for BPF and 25dB amplifier

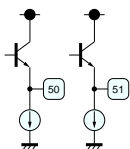
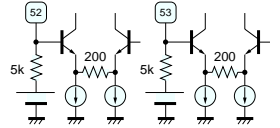
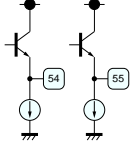
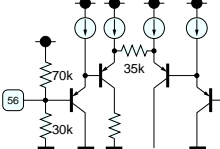
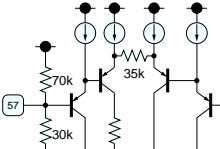
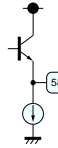
Pin No.	Pin name	Pin voltage	Internal circuit	Function
49	N.C.	—	—	—
50 51	F1AMP – OUT F2AMP – OUT	2.1 2.1		F1 amplifier output F2 amplifier output
52 53	F2AMP IN F1AMP IN	2.3 2.3		F2 amplifier input F1 amplifier input
54 55	F1BPF OUT F2BPF OUT	2.5 2.5		F1 BPF output F2 BPF output
56	F2 ADJ	1.5		F2 adjustment
57	F1 ADJ	1.5		F1 adjustment
58	GCA OUT	1.8		VCA output

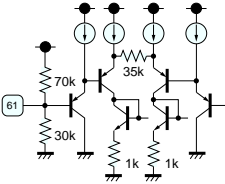
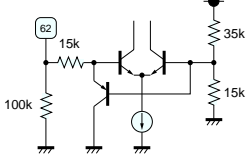
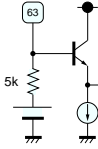
Pin No.	Pin name	Pin voltage	Internal circuit	Function
59	GND	—	—	GND for LPF and VCA
60	Vcc 5V	—	—	Vcc for LPF and VCA
61	GAIN ADJ	1.5		VCA gain adjustment
62	GAIN SW	0.0		VCA gain switching
63	LPF IN	3.8		LPF input
64	N.C.	—	—	N.C. pin Connect to ground to lower impedance

●Application example

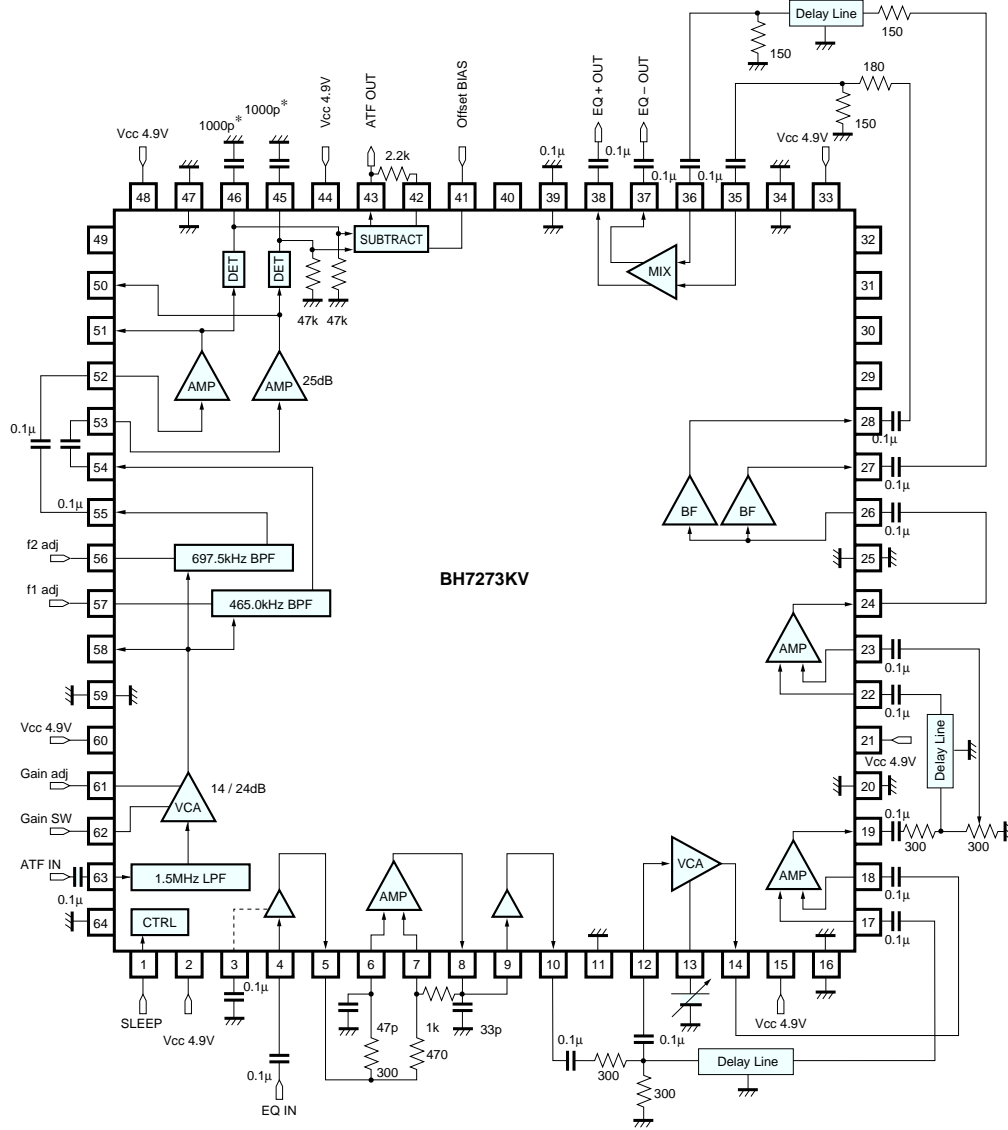

Fig. 2

●External dimensions (Units: mm)

