

*Advance Information*

# Digital Video Encoder

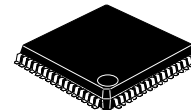
## RGB Output Support HCMOS Technology

The MC44724 and MC44725 are Digital Video Encoders (DVE). They convert ITU-601/656 standard 4:2:2 Bit-Parallel data into analog composite video, S-Video or Y/Cb/Cr or R/G/B in PAL and NTSC formats. They accept the multiplexed ((CB,Y,CR)Y) signals from digital sources such as MPEG decoders and can act as a sync generator master. All video processing is done digitally and requires no external adjustment.

Specifically designed for digital satellite, digital cable decoders and multimedia terminals.

- World Wide Operation (PAL-BDGHI, PAL-N, PAL-M, NTSC-M)
- SMPTE **170M** / ITU - **R 624** composite video output
- Programmable Color Sub-carrier Frequencies
- Analog **Horizontal, Vertical, Frame** or **Composite** Sync Outputs
- Sync Extraction From Digital Input Data (SAV, EAV)
- Sync Polarity and Horizontal Phase Control
- Master or Slave Sync (**H/Vsync, H/Fsync, ITU-R656 Slave**) Operation
- Interlaced or Non-Interlaced Support
- 625/50 or 525/60 ITU-601/656 **two 8-bit** or **16-bit** ((CB,Y,CR)Y) Digital Input
- Luma 2X / Chroma 4X Oversampling Filtering
- **External VBI Information Data Input** (such as TeleText Information Data)
- Selectable **Two sets** of Signals within (**CVBS/Y/C**) or (**Y/Cb/Cr**) or (**R/G/B**)
- **Six** Analog Outputs Through **10-bit** DACs
- Easily programmed via Serial Bus (**I2C** or **SPI** Bus)
- **2 Hardware I2C Chip Addresses**
- **Closed-Caption, CGMS** and **WSS** Information data Insertion
- **MACROVISION ver. 7.01** Anti-Copy Signal Insertion (MC44724 Only)
- On Chip **Color - bar** Generator
- **+3.3V** Power Supply or **+3.3V**(Digital)/**+5V**(Analog) Power Supply

# MC44724 MC44725

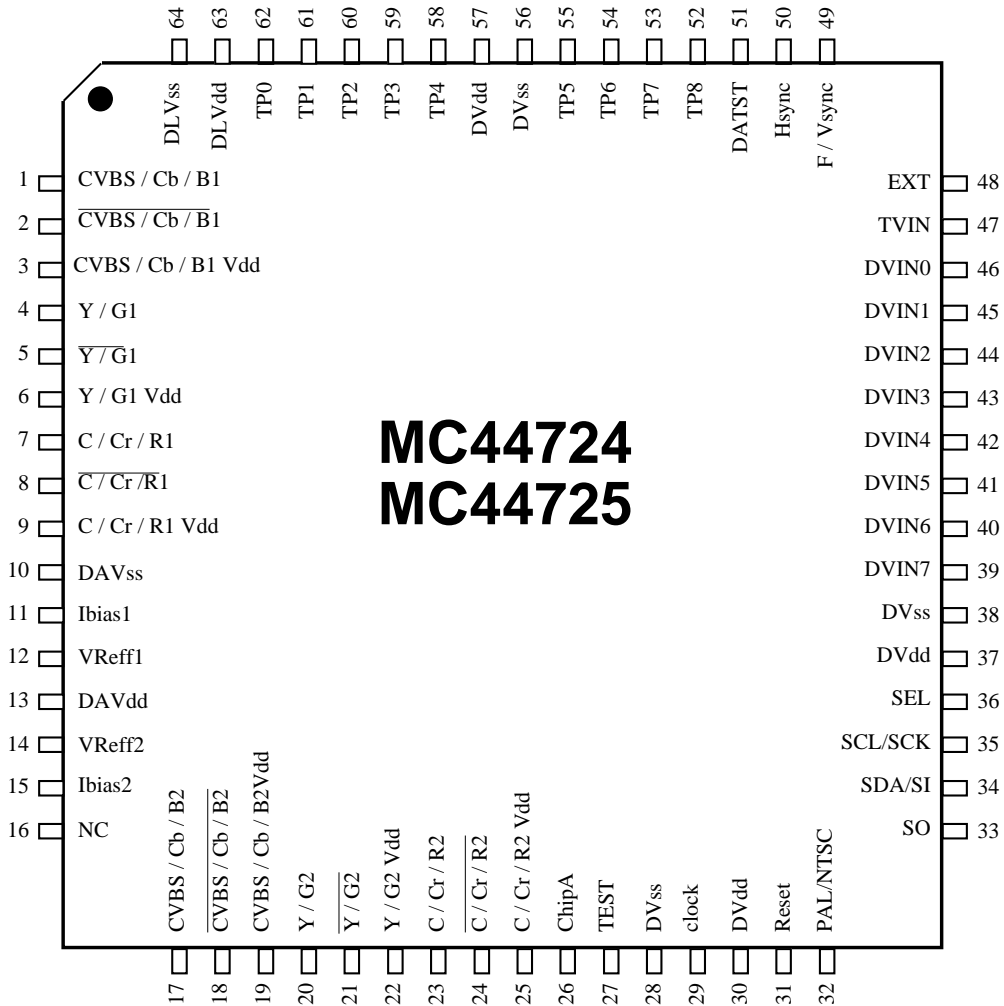


VFU SUFFIX  
64 VQFP  
(0.5mm Pitch)

The MC44724 device is protected by U.S. patent number 4,631,603,4,577,216 and 4,819,098 and other intellectual property rights. The use of Macrovision's copy protection technology in the device must be authorized by Macrovision and is intended for home and other limited pay-per-view uses only, unless otherwise authorized in writing by Macrovision. Reverse engineering or disassembly is prohibited.



[Pin Assignment]

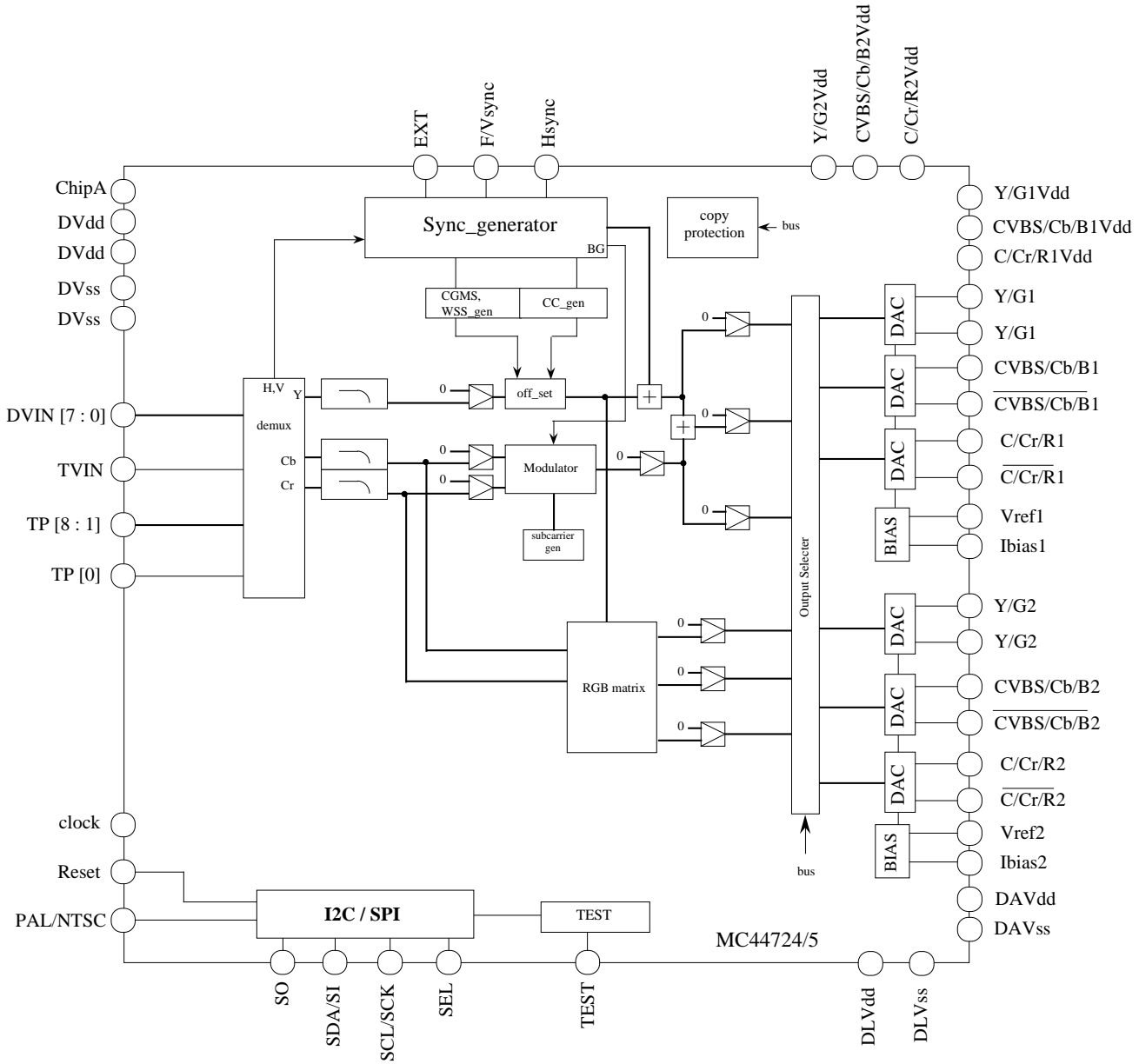


**[Pin Descriptions]**

PIN	NAME	I/O	DESCRIPTIONS
1	CVBS/Cb/B1	O	Analog composite video signal output or Cb or B signal output current drive(positive)
2	CVBS/Cb/B1	O	Analog composite video signal output or Cb or B signal output current drive(negative)
3	CVBS/Cb/B1Vdd		Power Supply for CVBS / Cb / B DAC circuit
4	Y/G1	O	Analog luminance or G signal output current drive(positive)
5	Y/G1	O	Analog luminance or G signal output current drive(negative)
6	Y/G1Vdd		Power Supply for Y / G DAC circuit
7	C/Cr/R1	O	Analog chrominance signal output or Cr or R signal output current drive(positive)
8	C/Cr/R1	O	Analog chrominance signal output or Cr or R signal output current drive(negative)
9	C/Cr/R1Vdd		Power Supply for C / Cr /R DAC circuit
10	DAVss		Ground for DAC circuit
11	Ibias1	O	Reference current for the 3 DACs1
12	Vref1		Reference full scale voltage for the 3 DACs1
13	DAVdd		Power Supply for the DACs
14	Vref2		Reference full scale voltage for the 3 DACs2
15	Ibias2	O	Reference current for the 3 DACs2
16	NC		No Connect to pin
17	CVBS/Cb/B2	O	Analog composite video signal output or Cb or B signal output current drive(positive)
18	CVBS/Cb/B2	O	Analog composite video signal output or Cb or B signal output current drive(negative)
19	CVBS/Cb/B2Vdd		Power Supply for CVBS / Cb / B DAC circuit
20	Y/G2	O	Analog luminance or G signal output current drive(positive)
21	Y/G2	O	Analog luminance or G signal output current drive(negative)
22	Y/GVdd		Power Supply for Y / G DAC circuit
23	C/Cr/R2	O	Analog chrominance signal output or Cr or R signal output current drive(positive)
24	C/Cr/R2	O	Analog chrominance signal output or Cr or R signal output current drive(negative)
25	C/Cr/R2Vdd		Power Supply for C / Cr /R DAC circuit
26	ChipA		I2C chip address select { 0 : 40(hex)/41(hex) 1 : 1D(hex )/1E(hex) }
27	TEST	I	TEST pin(Ground)
28	DVss		Ground for Digital circuit
29	CLOCK	I	27MHz clock input
30	DVdd		Power Supply for Digital circuit
31	Reset	I	Reset signal, active LOW
32	PAL/NTSC	I	NTSC/PAL select . This pin active only Reset time. (NTSC : Low PAL : High )
33	SO	z(O)	If SPI mode, serial data output / If I2C mode, connect to Ground
34	SDA/SI	I/O(I)	Serial data input, Open drain output / If SPI mode, serial data input
35	SCL/SCK	I	Serial clock
36	SEL	(I)	Connect to Ground / If SPI mode, this pin is chip select
37	DVdd		Power Supply for Digital circuit
38	DVss		Ground for Digital circuit
39~46	DVIN7~0	I/O	Multiplexed 4:2:2 data(CCIR Rec656/601) input (1)
47	TVIN	I/O	TEST data input
48	EXT	I/O	Csync/Frame sync output, or external VBI information input
49	F/Vsync	I/O	Frame sync or Vertical sync input/output
50	Hsync	I/O	Horizontal sync input/output
51	DATST	I	MUX swith in 8-bit X 2 Multiplexed 4:2:2 data(CCIR Rec656/601) input (1) and (2), or for D/A converter test
52~55	TP8~5	I/O	8-bit Multiplexed 4:2:2 data(CCIR Rec656/601) input (2), or Multiplexed Cr/Cb data (CCIR Rec656/601) input in 16-bit input mode, or Test data input/output (TP8 : MSB)
56	DVss		Ground for Digital circuit
57	DVdd		Power Supply for Digital circuit
58~61	TP4~1	I/O	Multiplexed 4:2:2 data(CCIR Rec656/601) input (2), or Multiplexed Cr/Cb data (CCIR Rec656/601) input in 16-bit input mode, or Test data input/output (TP1 : LSB)
62	TP0	I/O	Test data inout/output
63	DLVdd		Power Supply D/A Converter Digital circuit
64	DLVss		Ground for D/A Coverter Digital circuit



[Block Diagram]



I2C/SPI chip-address      40/41(hex)  
                                          1D/1E(hex)



[Function Descriptions]

**Clock**

27.0Mhz is necessary. This signal on the clock pin needs to be active before the reset pin is de-asserted. ( see figures 1 and 2 )

**Reset Procedure**

RESET is a level sensitive input pin. Driving the RESET pin low causes a DVE reset. The 27Mhz DVE clock signal must be active before RESET is released. De-asserting reset will latch the status of the PAL/NTSC, TVIN and SEL pins.

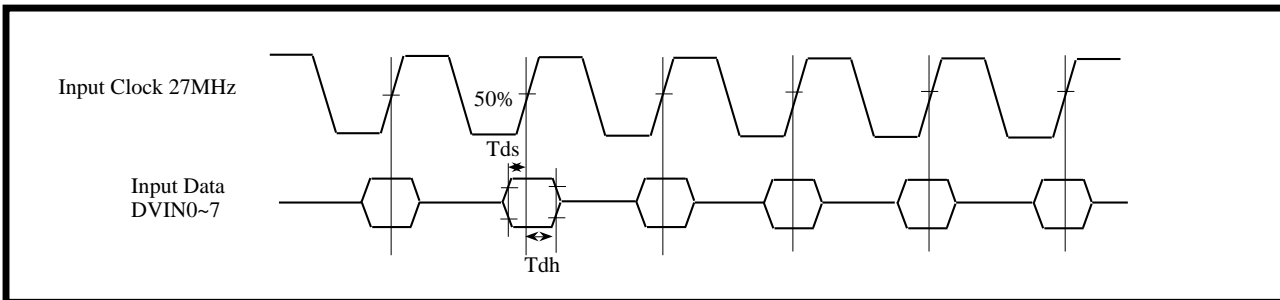
The PAL/NTSC pin determines the default values for the DVE control registers. The default register values have been chosen so that standard PAL or NTSC video will appear at the DAC outputs immediately when a valid input digital video data stream is present.

The value on the SEL pins determine the default serial communication mode. If Low, the DVE use I2C bus operation. If High, the DVE use 4-wired SPI operation.

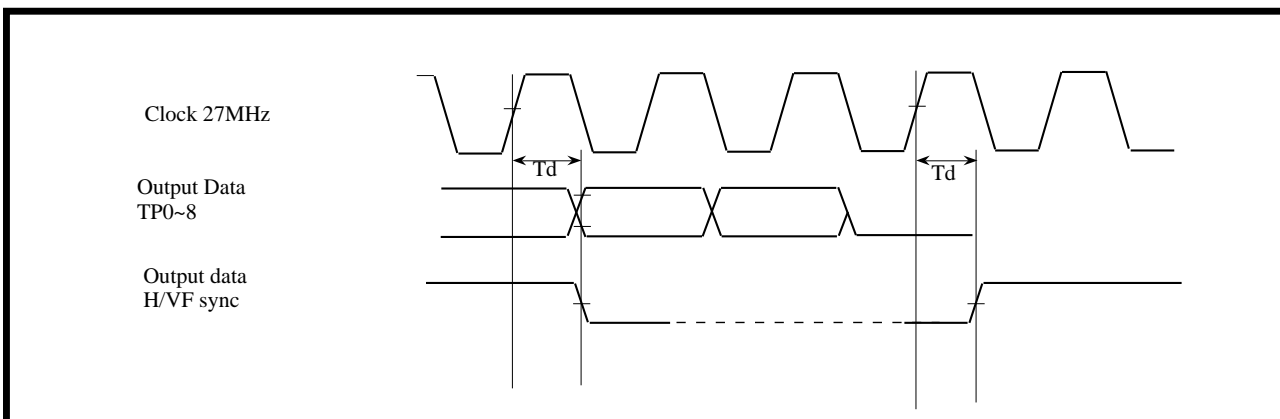
After reset, the VBI signals (Closed-Caption, CGMS and WSS ) are disabled.

(see page --- for sub-address register descriptions.)

**Fig 1 : DVIN Data Input Timing**



**Fig 2 : Sync Data Output Timing**





**Input Data Format**

The input digital video is in accord with the ITU-R Rec.656 and SMPTE 125M standards. It is an two 8-bit or 16-bit multiplexed 4:2:2 ((CB,Y,CR)Y) data stream. Samples are latched on the rising edge of the clock signal. Data is input on pins **DVIN[ 7 : 0 ]** and **TP[ 8 : 1 ]** (see figures 3 and 4 for sub-address register descriptions.)

**Video Timing / Sync Generator**

The DVE outputs PAL-B,D,G,H,I, PAL-N, PAL-M or NTSC-M standard video signals.

The DVE sync generator can be operated in two modes, master or slave.

In master mode, the DVE generates all the correct Horizontal and Vertical or Frame sync signals internally, or it is output Csync signal through the EXT pin(C/Fsync).

In slave mode, the DVE derives the sync signals from the Bit-Parallel input data stream Start Active Video (SAV) and End Active Video (EAV) data packet information. Sync signals are output on the Hsync and F/Vsync or EXT pins and can be programmed for positive or negative polarity. The phase of Hsync can also be controlled.

Also, the DVE allows more two slave modes. One is H/Vsync slave, and the aother is H/Fsync slave mode.

Vertical Blanking corresponds to the following lines.

625/50 624-22 311-335 ITU-R line numbering  
525/60 1-19 264-282 SMPTE line numbering

(see figures 3,4,5,6,7,8,9,10, and 11 for sub-address register descriptions.)

**Fig 3 : Digital Input Timing(525/60 system) in Master Mode**

70(hex){[1:0]=01}

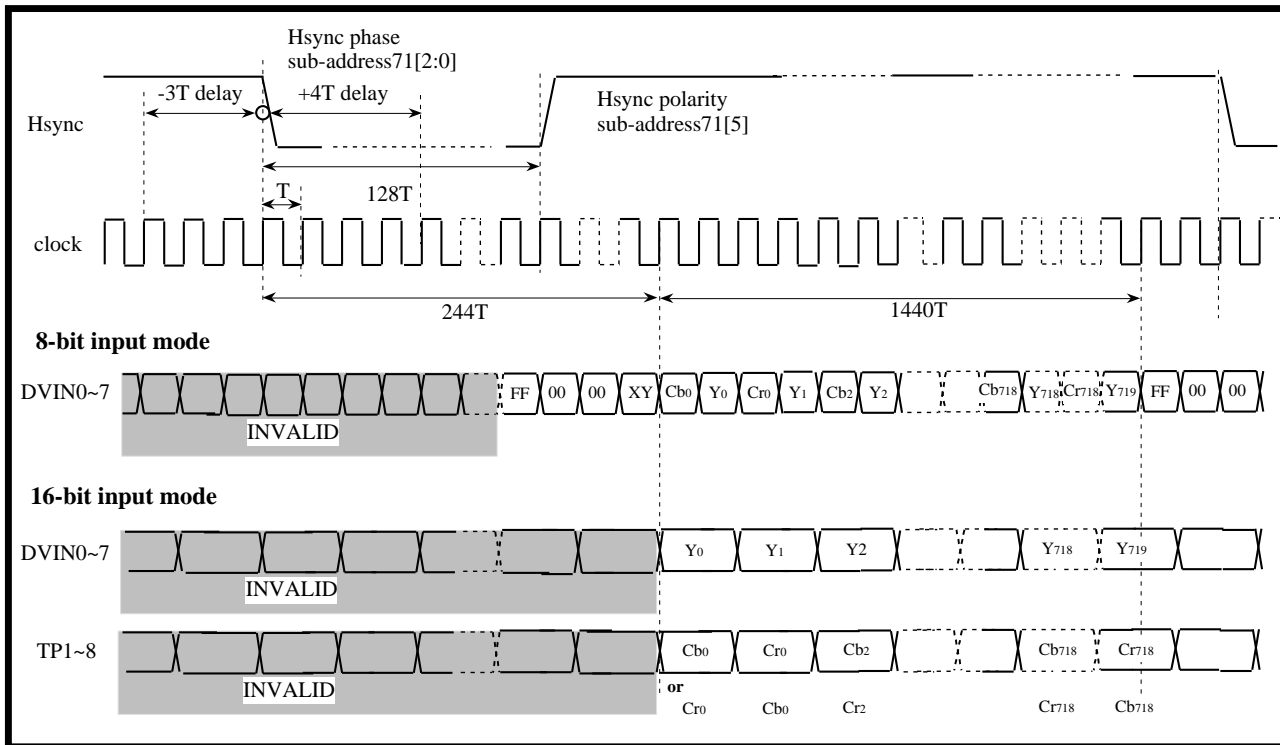




Fig 4 : Digital Input Timing(625/50 system) in Master Mode

70(hex){[1:0]=01}

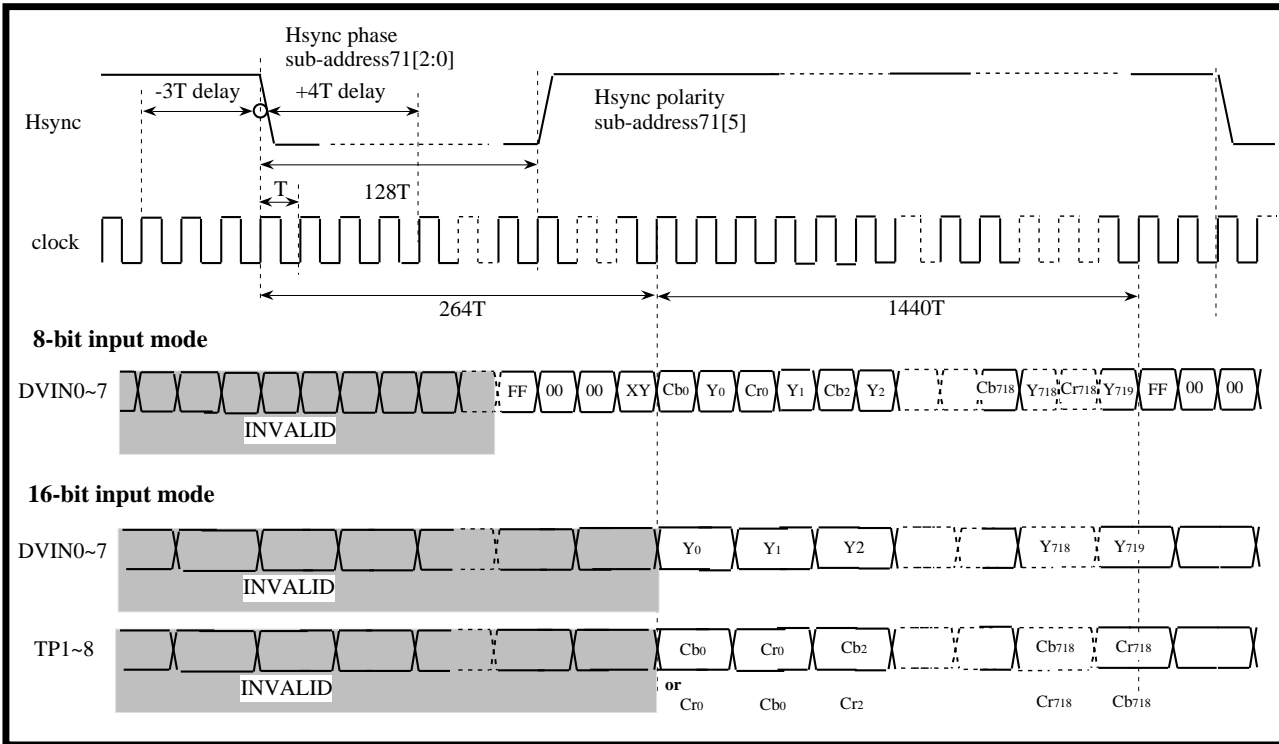


Fig 5 : Sync Timing::525/60 Interlaced System in Master Mode

sub-address71[7] =0

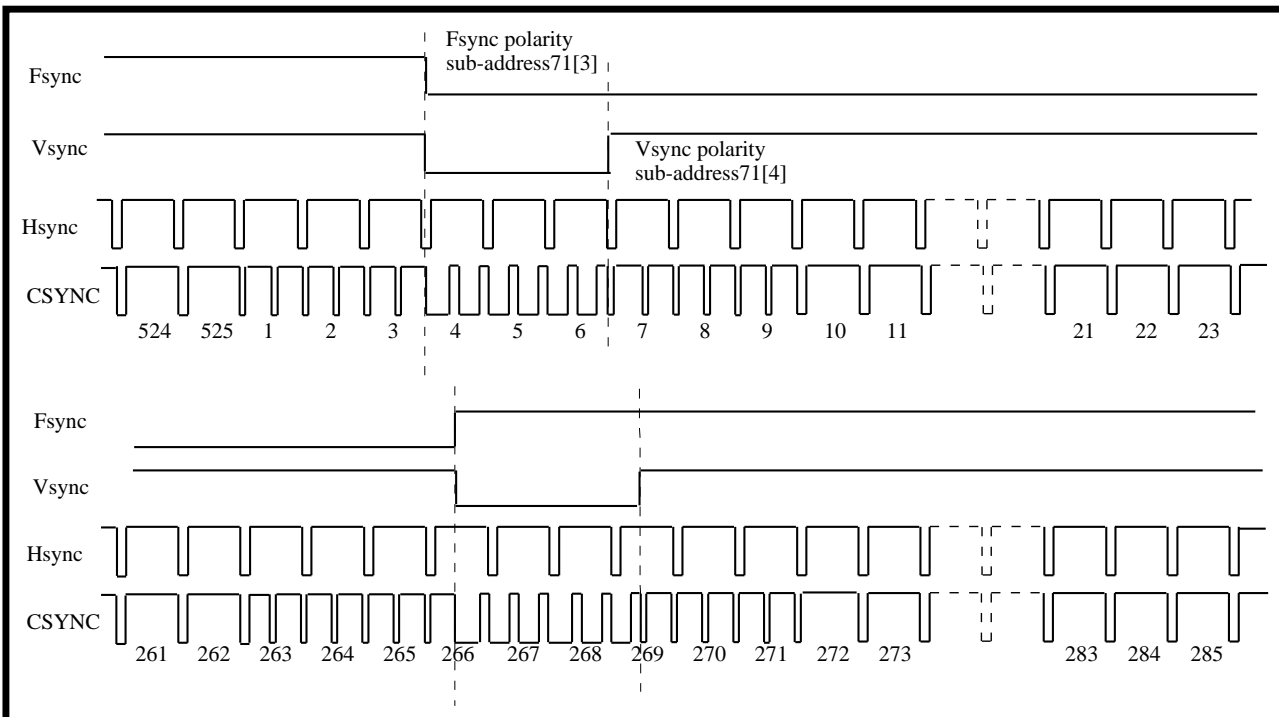




Fig 6 : Sync Timing::625/50 Interlaced System in Master Mode

sub-address71[7] =0

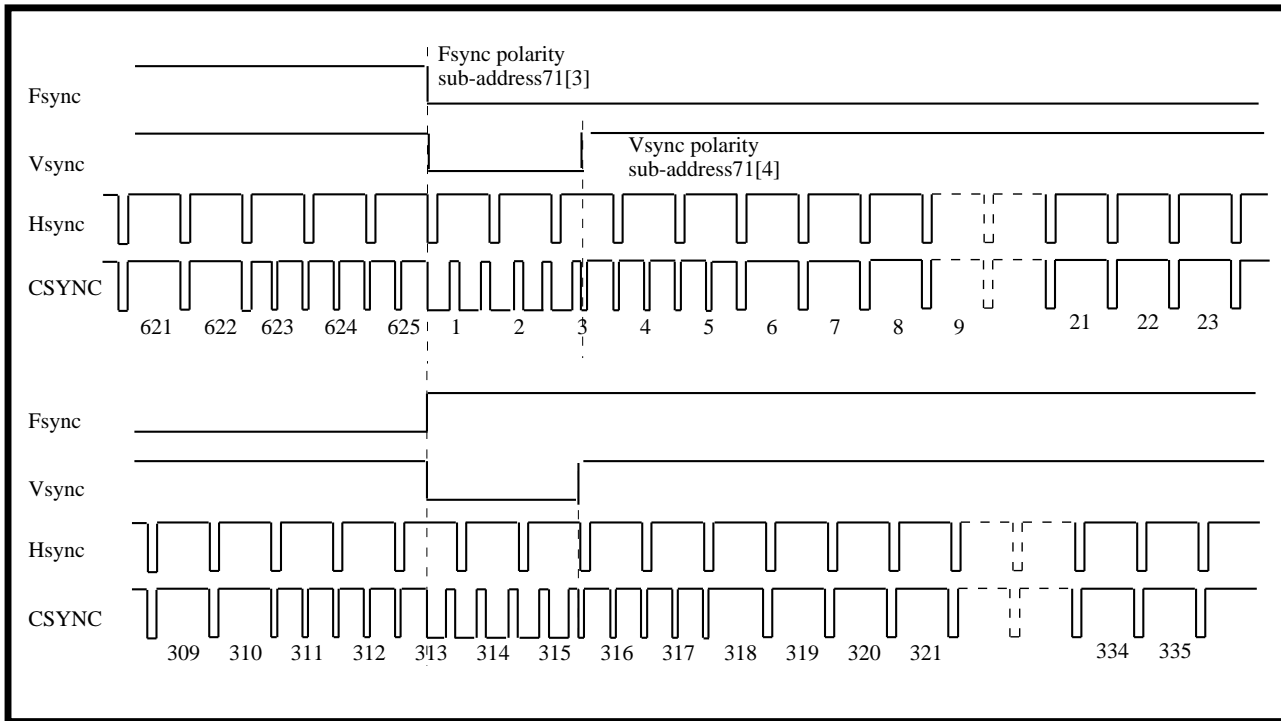


Fig 7 : Sync Timing::525/60 Non-interlaced System in Master Mode

sub-address71[7] =1

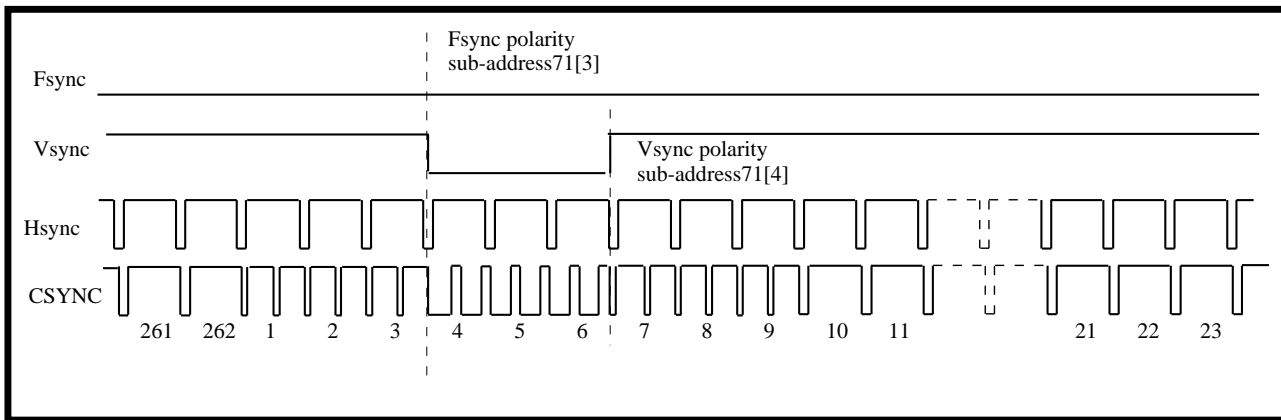


Fig 8 : Sync Timing::625/50 Non-interlaced System in Master Mode

sub-address71[7] =1

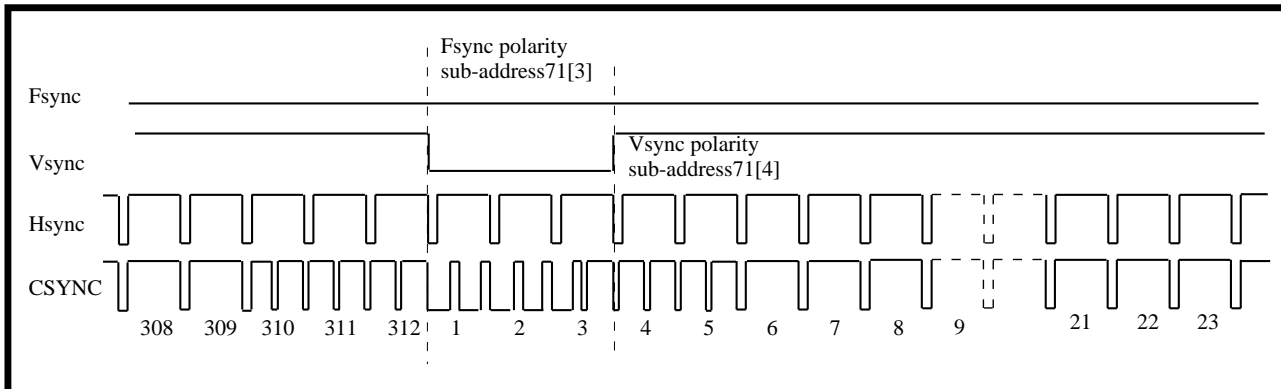






Fig 9 : Analog Sync Timing::Rise and fall

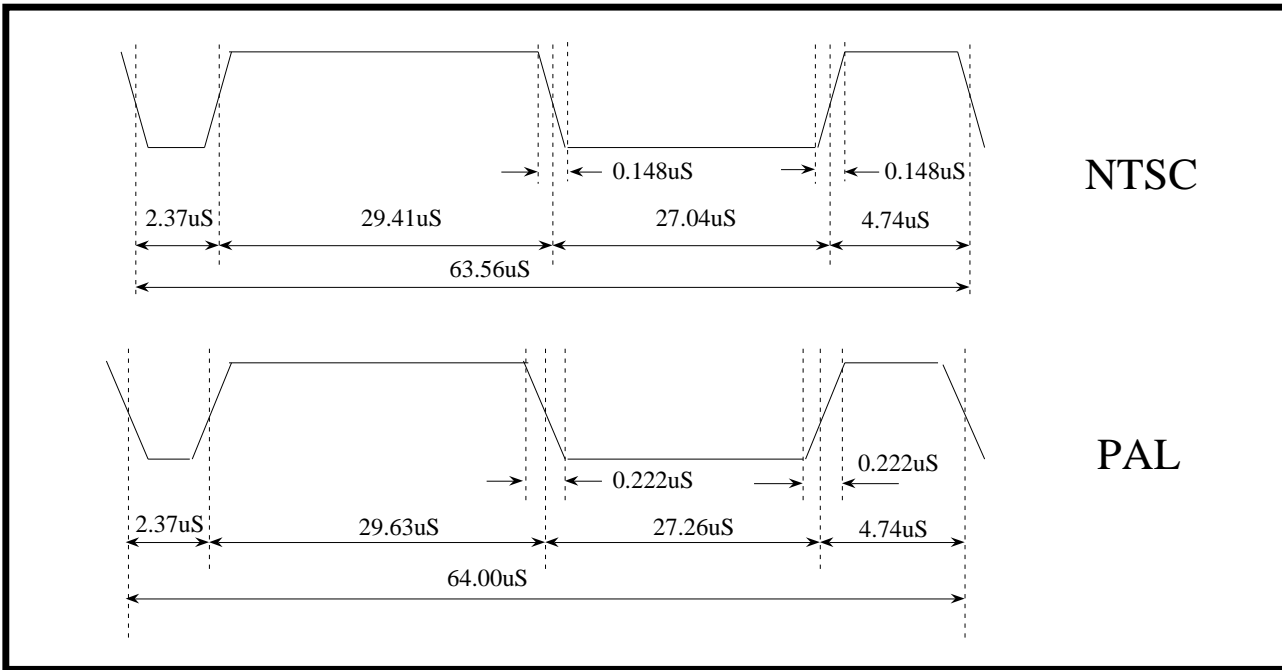


Fig 10 : Sync Timing::525/60 Interlaced System in Slave Mode

sub-address71[1:0] =10, 11

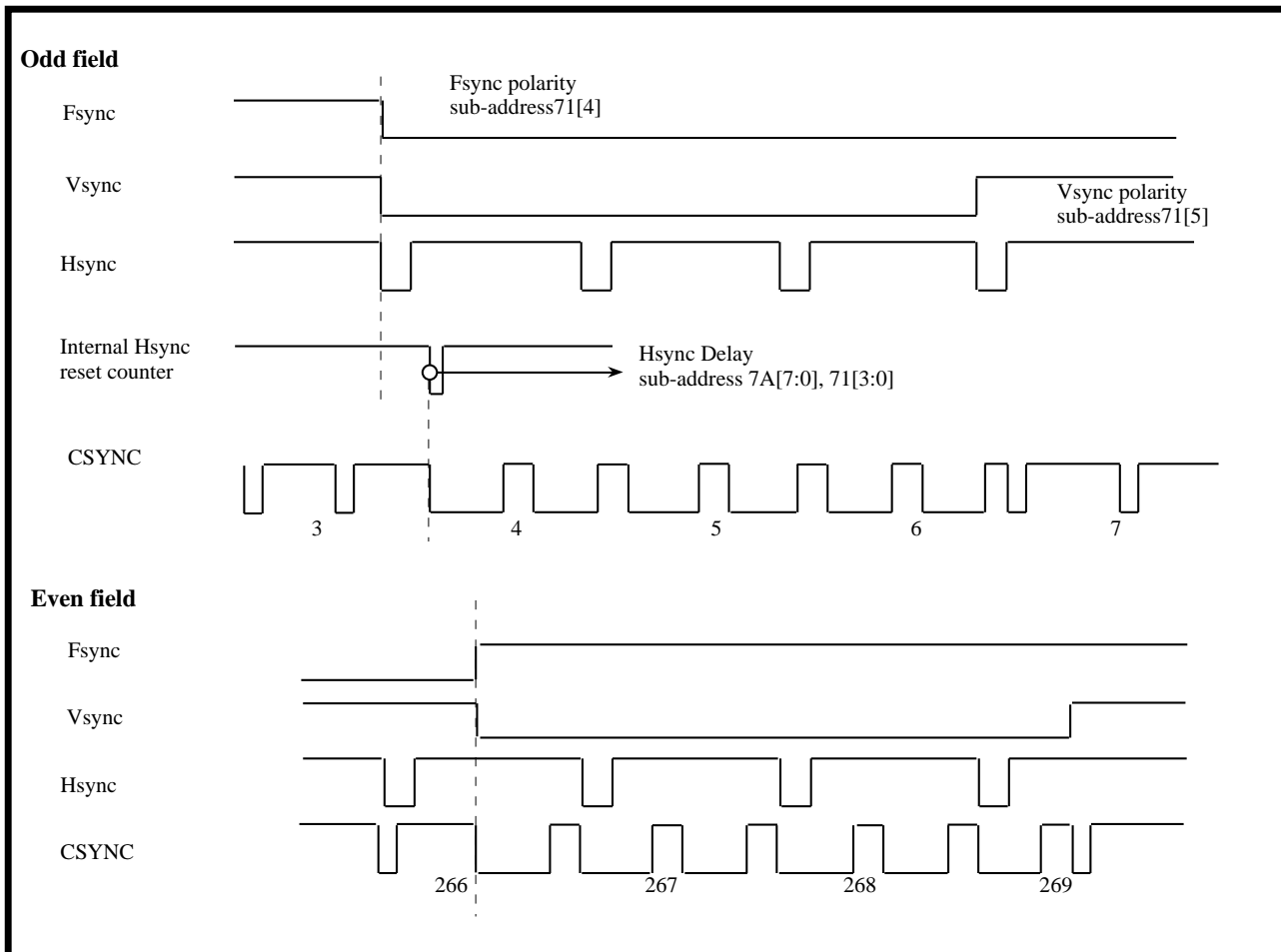
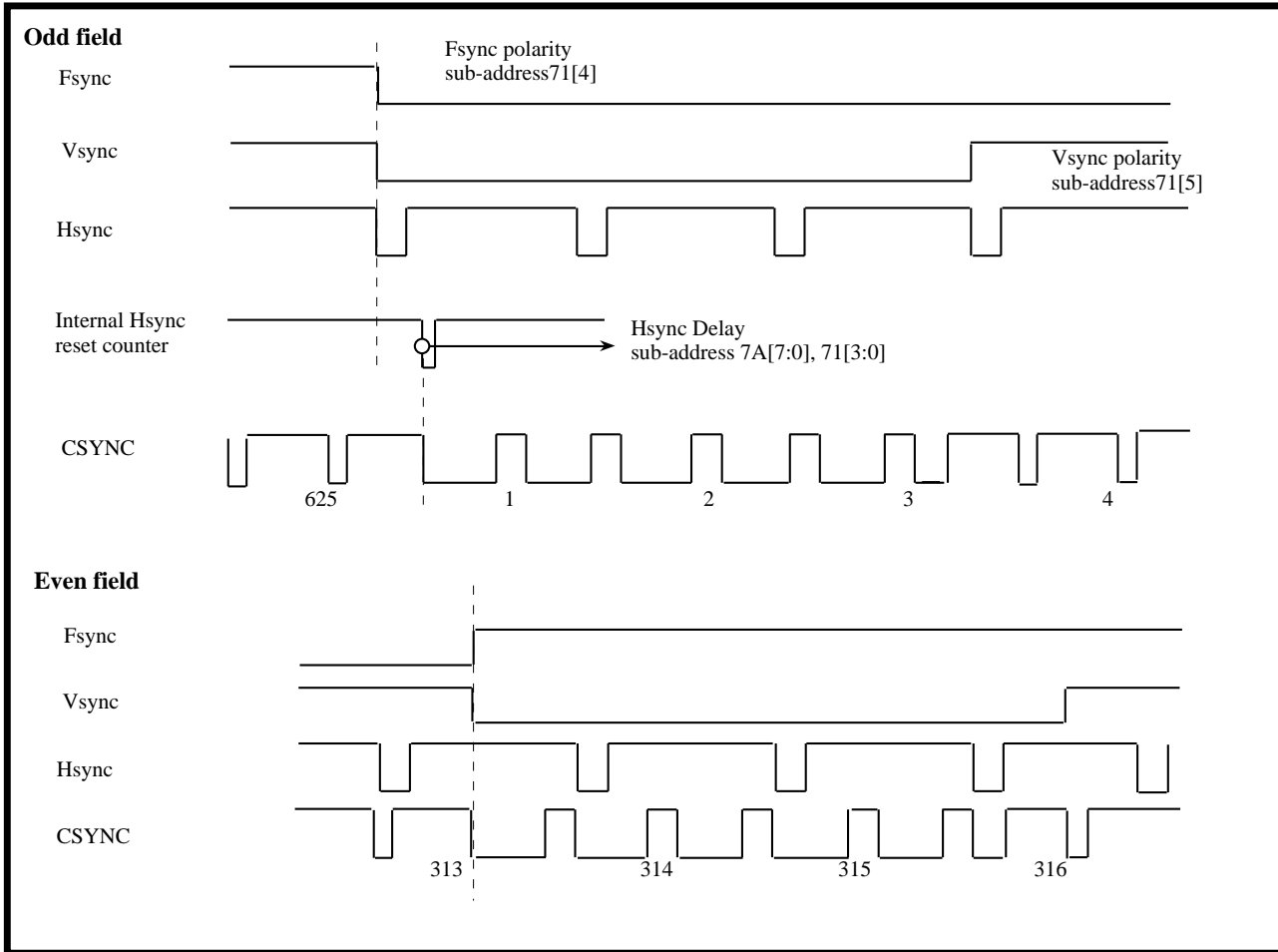




Fig 11 : Sync Timing::625/50 Interlaced System in Slave Mode

sub-address71[1:0] =10, 11





### **Chroma / Luma Encoding**

The DVE de-multiplexes the 4:2:2 digital video data stream.

The de-multiplexed Y or Luma samples are interpolated (2X oversampled) at the clock rate. Offset compensation is then added, next any VBI signals consisting of Closed-Caption, CGMS and WSS are added to the appropriate lines, then finally composite sync pulses are added to the Luma signal. (see figure 12.)

De-multiplexed component color CB and CR samples are interpolated (4X oversampled) at the clock rate. Interpolating simplifies the output filter and allows more accurate encoding. The DVE generates the necessary subcarrier color frequency for PAL or NTSC encoding from the 27Mhz system clock. This color subcarrier is then modulated by the base band component color CB and CR signals to create the video Chroma signal. (see figure 13.)

A 7.5 IRE pedestal is added for the 60Hz field rate. This can be added for the 50Hz field rate through serial bus control. (see sub-address register descriptions)

### **CVBS and S-VIDEO or YCbCr or RGB Outputs**

The internal digital video signals drive 10-bit D/A converters. Converter outputs are bi-directional current sources where the current is proportional to the digital data with reference to the IBIAS reference current. The pins CVBS/Cb/B, Y/G and C/Cr/R are the respective composite, Luma and Chroma or Y/Cb/Cr or R/G/B signal current source pins. Also, each DACs can drive **75ohm** load register.

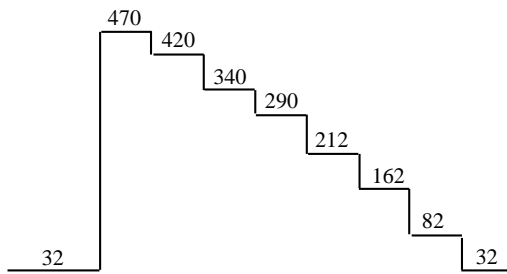
User can select 2 sets of signals within above 3 sets.  
(see "Application Diagram" and "sub-address register descriptions".)

#### **Bias Current Gain**

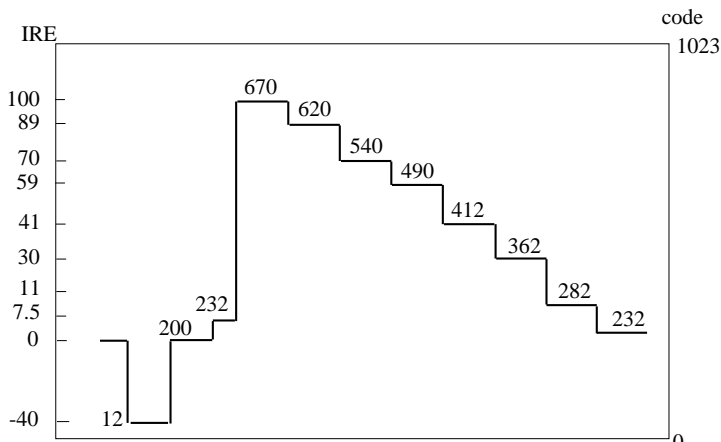
DACs can be switched off through serial bus control to reduce power consumption. Both outputs of unused DACs should be connected to ground through a resistor to avoid charge buildup.



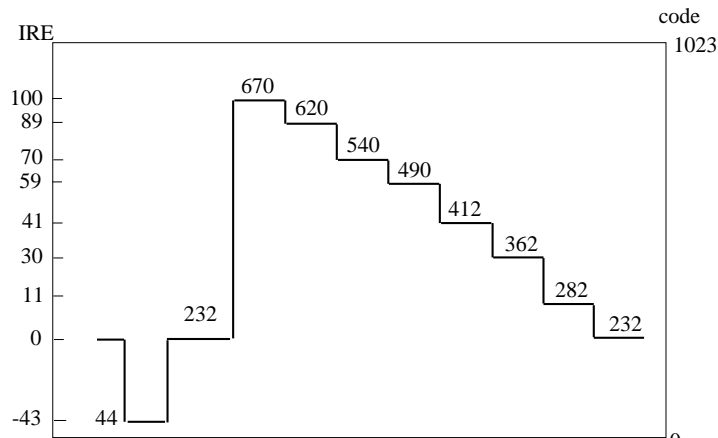
Fig 12 : Luminance Output Range



Digital Y input code(16~235)  
525/60 and 625/50 system  
100%amplitude,100%saturation color bar



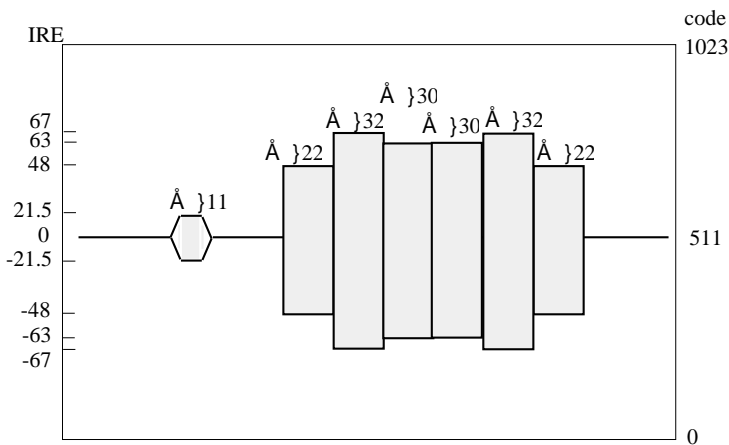
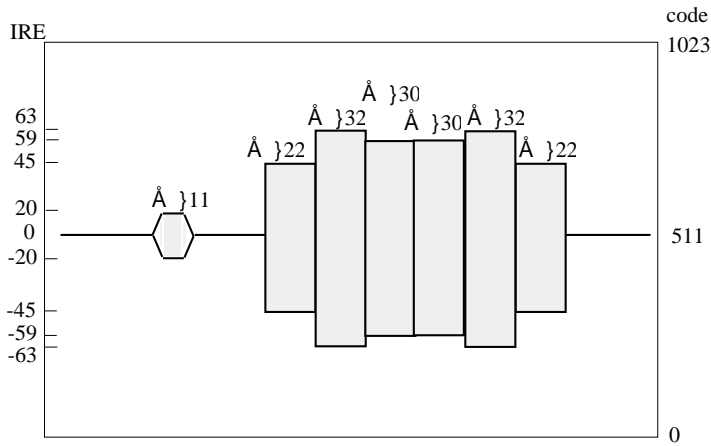
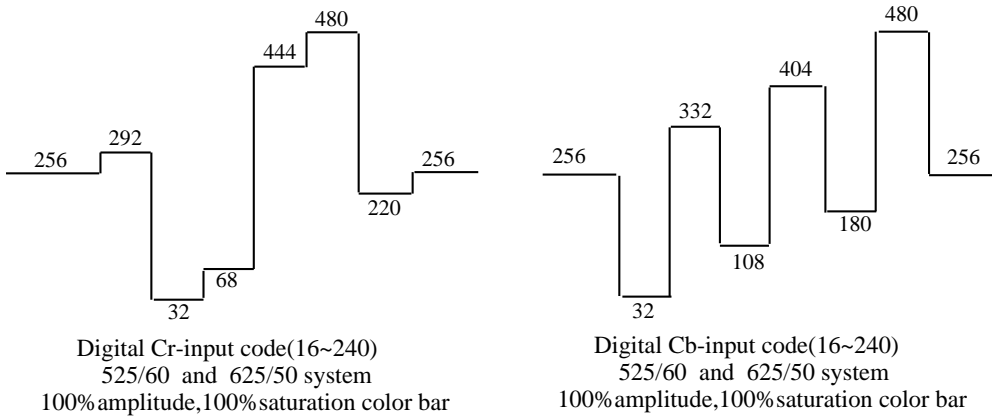
Analog Y output level(525/60 system)  
100%amplitude,100%saturation color bar



Analog Y output level(625/50 system)  
100%amplitude,100%saturation color bar

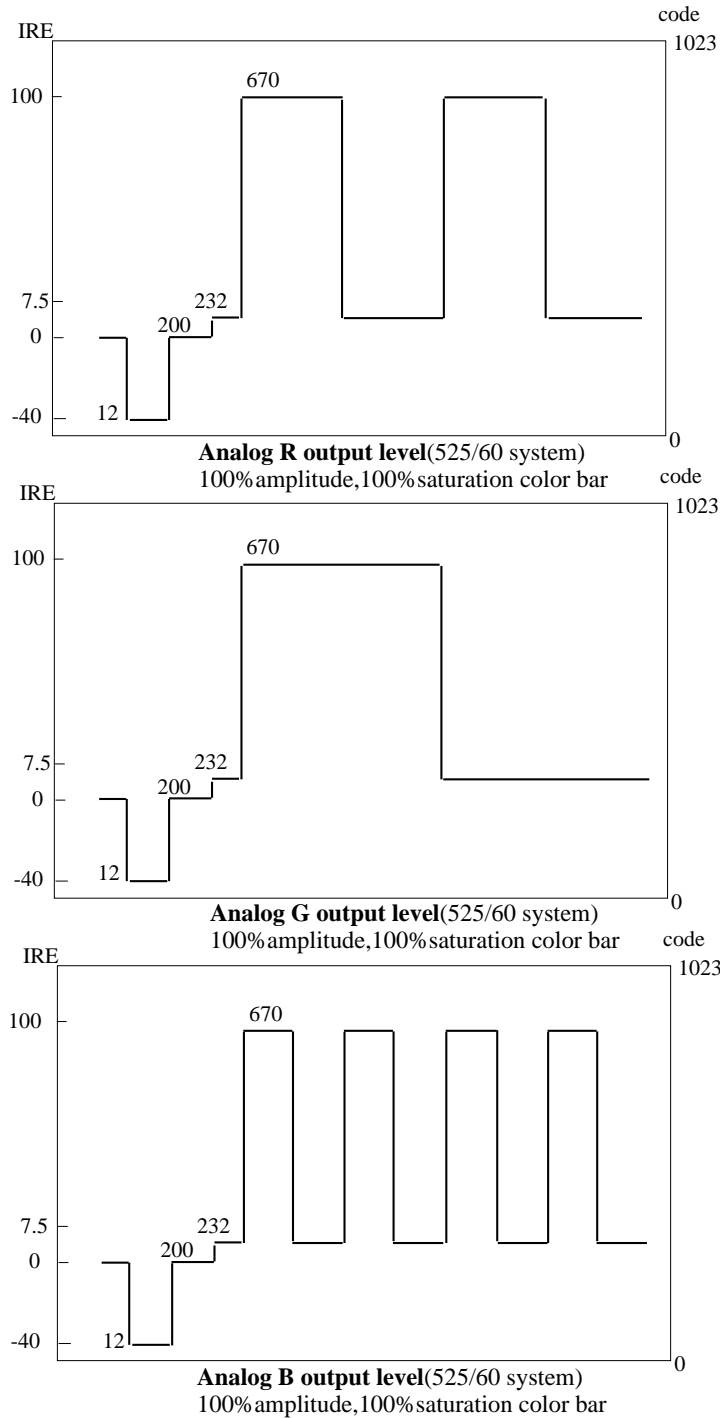


Fig 13 : Chrominance Output Range





**Fig 14 : RGB Output Range for 525/60 system**

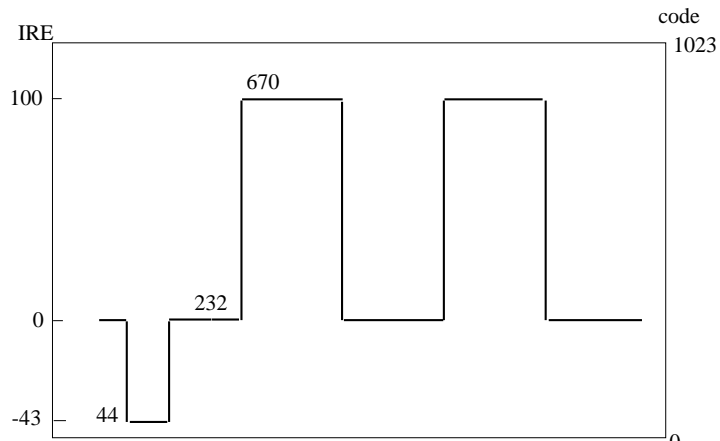


**Transformation**

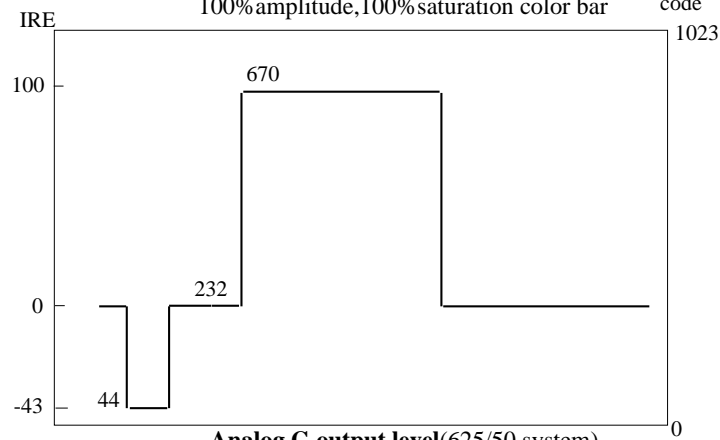
- a)  $R = Y + 1.371 (Cr - 128)$
- b)  $G = Y - 0.698 (Cr - 128) - 0.336 (Cb - 128)$
- c)  $B = Y + 1.732 (Cb - 128)$



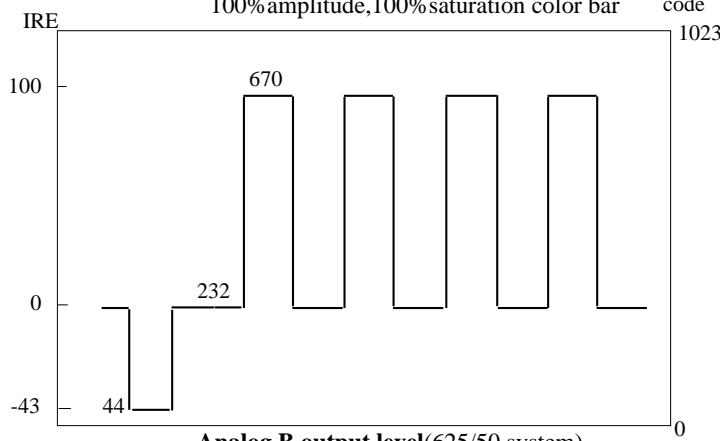
**Fig 15 : RGB Output Range for 625/50 system**



**Analog R output level(625/50 system)**  
100%amplitude,100%saturation color bar



**Analog G output level(625/50 system)**  
100%amplitude,100%saturation color bar



**Analog B output level(625/50 system)**  
100%amplitude,100%saturation color bar

**Transformation**

- a)  $R = Y + 1.371 (Cr - 128)$
- b)  $G = Y - 0.698 (Cr - 128) - 0.336 (Cb - 128)$
- c)  $B = Y + 1.732 (Cb - 128)$

**Copy Generation Management System (CGMS) Encoding**

CGMS signals can be encoded by the DVE onto output video line 20 (525 / 60 for Japan). CGMS identification signals also identify and control the TV screen presentation mode - wide screen, letterbox and or normal -16:9 or 4:3.

(see figures 18 for sub-address register descriptions.)

**Closed-Caption Encoding**

Closed-Captioned or Extended Data Service signals can be encoded by the DVE onto output video line 21/284 (NTSC) and line 22/335 (PAL). The CC data is input through the serial bus interface. Two 8-bit byte data pairs are encoded for each field. There are four registers for holding the data - two bytes per field. The serial data is 7bit US-ASCII MSB first, preceded by an odd parity bit. Total 8-bits. (P-7-6-5-4-3-2-1-0)

The DVE automatically generates the required clock run in and start bit for CC encoding. (see figure 16.) When Closed-Captioning is enabled, the system micro processor (uP) should update the CC data once each frame. The system uP should also write NULL characters when there is no CC data to encode. It is also recommended to write CC data only to the inactive frame. Field1 and Field2 data are double-buffered by the Frame sync falling edge of previous Frame, updating Frame 2 data during Frame1 display and Frame1 data during Frame2 display.

(see figures 20 for sub-address register descriptions.)

**Wide Screen Signalling (WSS) Encoding**

WSS signals can be encoded by the DVE onto output video line 23 (625 / 50 for Europe). WSS identification signals also identify and control the TV screen presentation mode - wide screen, letterbox and or normal -16:9 or 4:3.

(see figures 19 for sub-address register descriptions.)





### **Serial Control Bus**

Control of the DVE device is accomplished through the **I2C**-Bus or **SPI** serial bus.

In **I2C** mode, pins **SDA** and **SCL** are the respective data and clock signals. Device address can be 40(hex)/41(hex) or 1E(hex)/1F(hex). Slave address is chosen at reset by the state of the ChipA pin signal { 0 : 40(hex)/41(hex), 1 : 1E(hex)/1F(hex) }

Sub-address register read and write operations are documented in the following section.

In **SPI** mode, pins **SO**, **SI**, **SCK** and **SEL** are the respective data input, output, serial clock and chip select signals. Register read and write operations are documented in the following section.

### **MACROVISION™ Copy Protection**

When enabled, the Luma and Chroma signals are modified according to the **MACROVISION™** copy protection process for Pay Per View (PPV) applications revision **7.01** dated Sep 6th, 1996.

Enabling and control is through the serial control bus.

No parts will be sent to the customer until the customer provides **MOTOROLA** with written confirmation of a license, non-disclosure or waiver from **MACROVISION™**.

If your customer would **NOT** like to use this feature or customer do **NOT** have an agreement of the copy protection with **MACROVISION**, and then you should recommend the **MC44723FT** (no copy guard part).



Fig 16-a : I2C-BUS Interface Write operation Timing

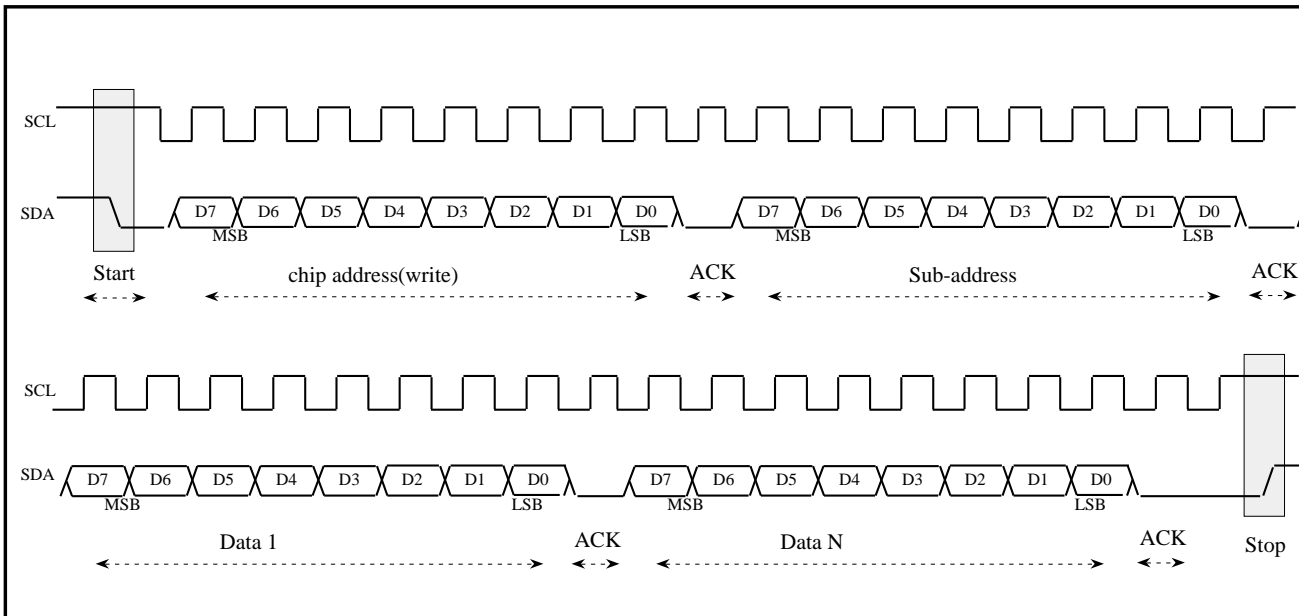


Fig 16-b : I2C-BUS Interface Read operation Timing

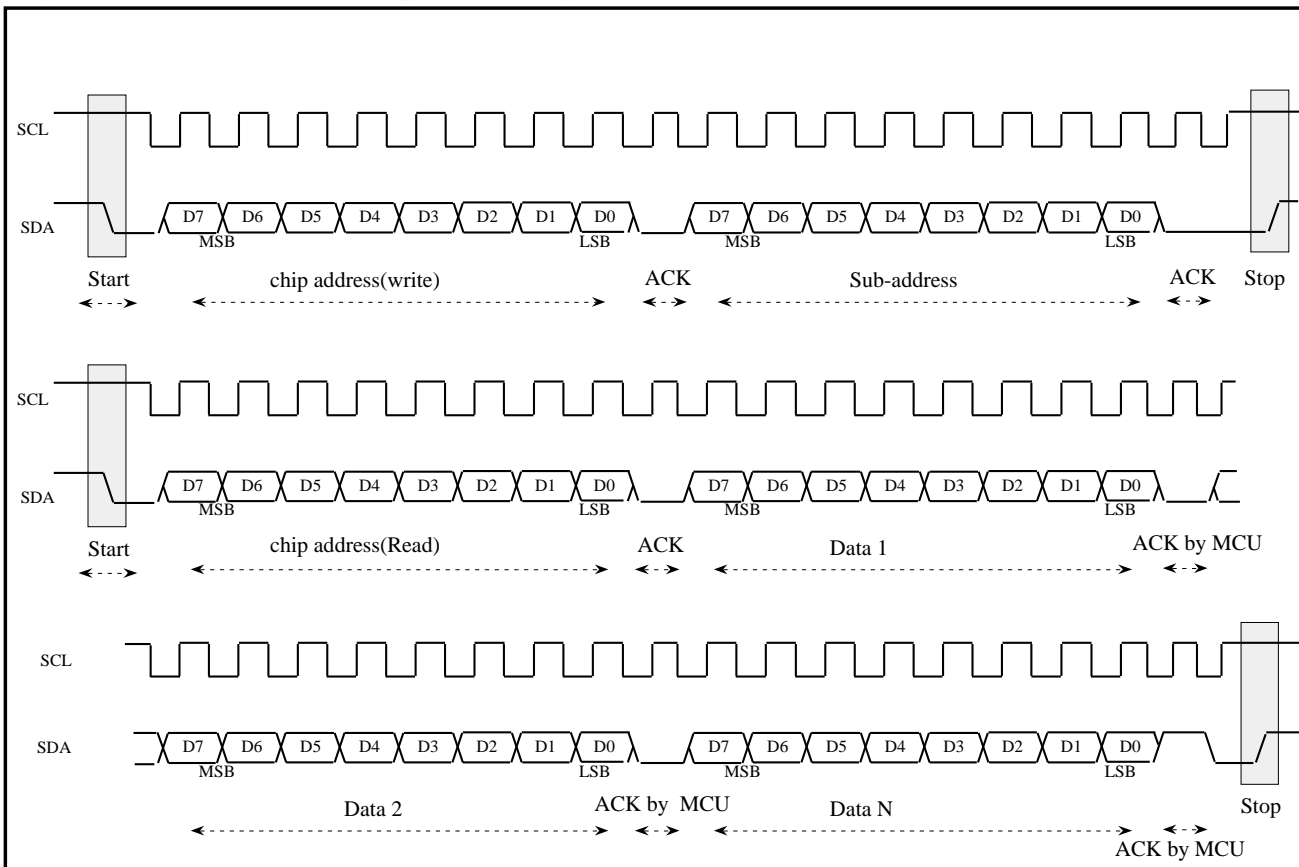




Fig 17-a : SPI-BUS Interface Write operation Timing

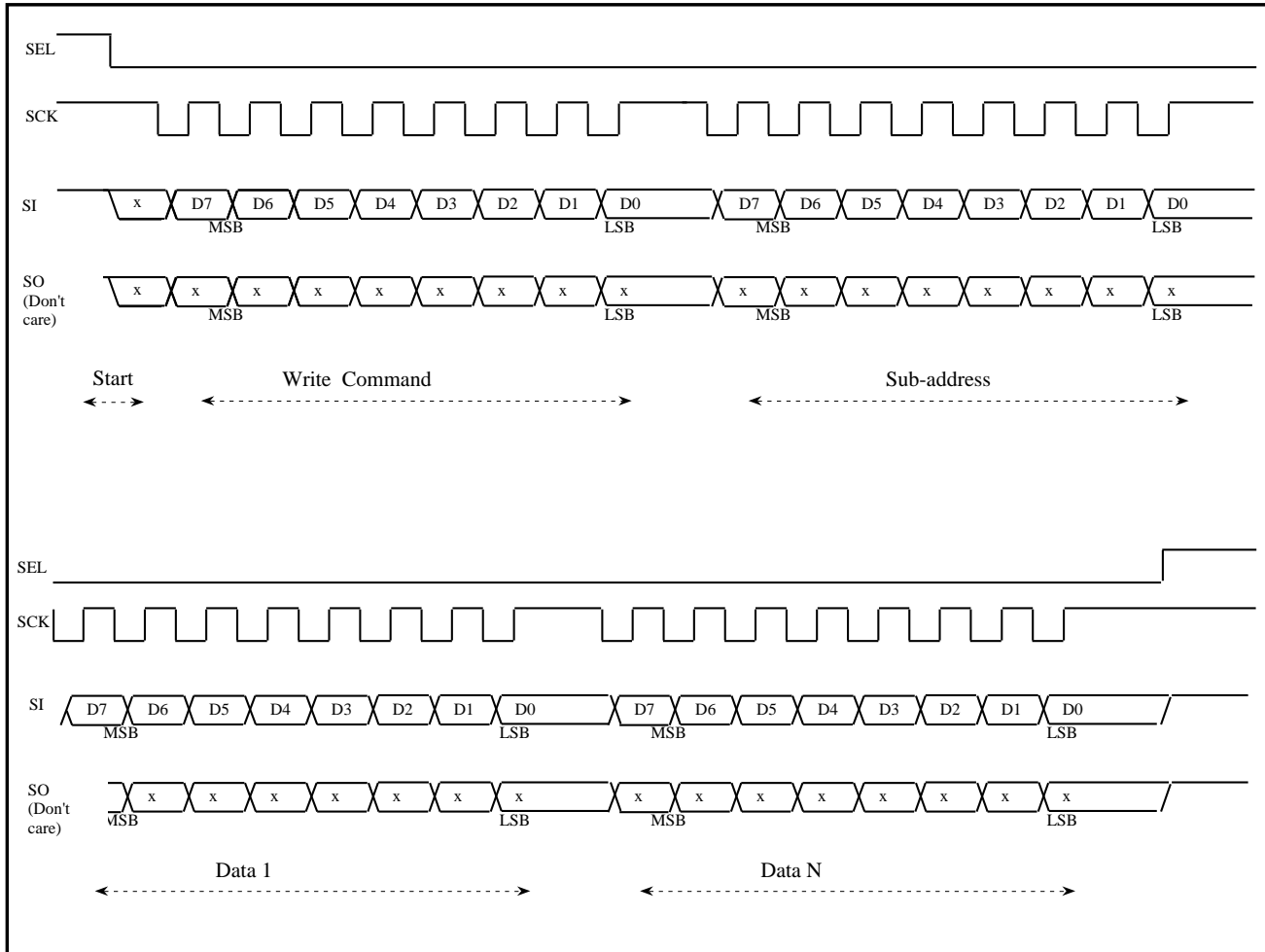
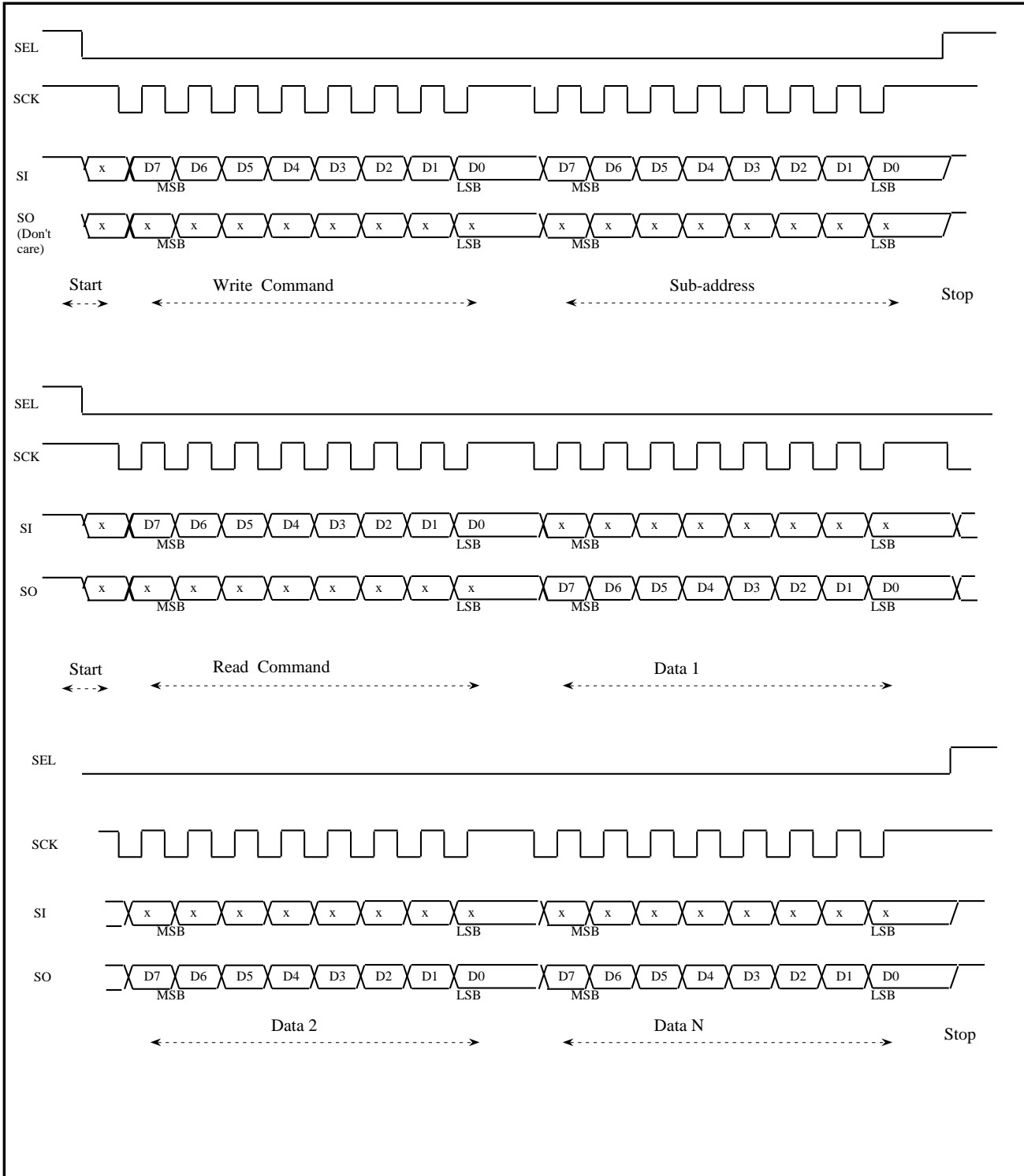




Fig 17-b : SPI-BUS Interface Read operation Timing



**[Specifications]***Maximum Ratings*

DC Supply Voltage	Vdd	-0.5 ~ +7.0	V
Input Voltage, All Inputs	Vin	-1.5 ~ Vdd+1.5	V
Output Voltage, All Outputs	Vout	-0.5 ~ Vdd+1.5	V
DC Output Current, per Pin	Iout	25	mA
Power Dissipation	Pd	750	mW
Storage Temperature	Tstg	-65 ~ +150	°C

*Electrical Characteristics*

Characteristic	Symbol	Min	Typ	Max	Unit
Power Supply Voltage(Analog Blocks) DAVDD	AVDD	3.1 4.75	3.3 5.0	3.5 5.25	V
Power Supply Voltage(Digital Blocks) DVDD	DVDD	3.1	3.3	3.5	V
Supply Current(Analog Blocks)	Aicc	-	30	-	mA
Supply Current(Digital Blocks)	Dicc	-	170	-	mA
Operating Temperature	Ta	0	-	70	°C

*DAC Blocks Characteristics(Power Supply 3.3V, Ta=25°C)*

Characteristics	Symbol	Min	Typ	Max	Unit	Other
Resolution	-	-	-	10	Bit	
Integral Non-Linearity	INL	-	-	±4.0	LSB	Vref = 1.1V
Differential Non-Linearity	DNL	-	-	±2.0	LSB	Vref = 1.1V
Analog Output Voltage	Vyo	0.85	1.00	1.15	Vp-p	Vref = 1.5V
Full Scale Output Voltage	Vyfs	0.85	1.00	1.15	V	
Zero Scale Output Voltage	Vyzs	-	0.0	0.1	V	
External Load Resistance	RL	75	120	-	Ω	

*DAC Blocks Characteristics(Power Supply 5.0V, Ta=25°C)*

Characteristics	Symbol	Min	Typ	Max	Unit	Other
Resolution	-	-	-	10	Bit	
Integral Non-Linearity	INL	-	-	±4.0	LSB	Vref = 1.5V
Differential Non-Linearity	DNL	-	-	±2.0	LSB	Vref = 1.5V
Analog Output Voltage	Vyo	-	1.5	2.0	Vp-p	Vref = 2V
Full Scale Output Voltage	Vyfs	-	1.5	2.0	V	Vref = 2V
Zero Scale Output Voltage	Vyzs	-	0.0	0.1	V	
External Load Resistance	RL	75	240	-	Ω	



[Specifications]

*Clock Blocks Characteristics*

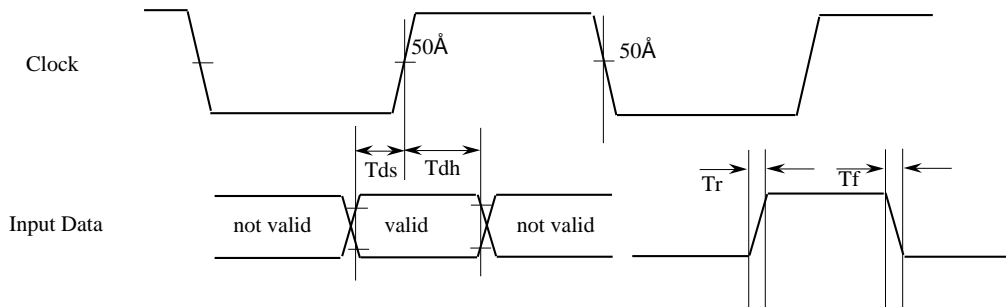
Characteristic	Symbol	Min	Typ	Max	Unit
Clock Rate	fc	-	27.0	-	MHz
Clock Duty Cycle	Dty	45	50	55	%

*Digital Blocks Electrical Characteristics (Power Supply 3.3V, Ta=25°C)*

Characteristics	Symbol	Min	Typ	Max	Unit
Input Voltage HIGH	ViH	2.0	-	-	V
Input Voltage LOW	ViL	-	-	0.8	V
Output Voltage HIGH (2.0mA)	VoH	2.4	-	-	V
Output Voltage LOW	VoL	-	-	0.4	V
Input Leakage Current	Iin	-	±2.5	-	µA
Hi-Z Leakage Current	Ioz	-	±20	-	µA
Input Capacitance	Cin	-	-	20	pF
Load Capacitance	CL	-	-	20	pF
Data Setup Time	Tds	4	-	-	nS
Data Hold Time	Tdh	5	-	-	nS
Input Rise Time	Tr	-	-	5	nS
Input Fall Time	Tf	-	-	5	nS
Data delay	Td	-	-	27	nS

*IIC/SPI-BUS Blocks Characteristics (Power Supply 3.3V, Ta=25°C)*

Characteristics	Symbol	Min	Typ	Max	Unit
Input Voltage LOW	VILM	-	-	0.8	V
Input Voltage High	VIHM	2.3	-	-	V
Input Current	VIM	-	-	±10	µA
SDA Output Voltage (IOM=3mA)	VOM	-	-	0.4	V
Output Current (during acknowledge)	IOM	3	-	-	mA

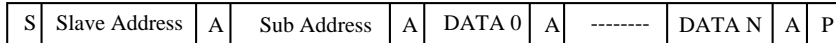




**[I2C-BUS Slave Address 40(hex)/41(hex) or 1E(hex)/1F(hex)]**

**<I2C-Bus Format>**

WRITE MODE

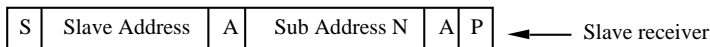


40(hex) or 1E(hex)

if more than 1byte DATA is transmitted,  
then auto-increment of the Sub Address is performed

- S Start condition
- Slave Address 40(hex) or 1E(hex)
- A Acknowledge, generated by the slave
- Sub Address Sub address byte
- DATA 0 First data byte
- DATA N continued data byte(Sub Address is auto increment)
- P Stop condition

READ MODE



40(hex) or 1E(hex)

then



41(hex) or 1F(hex)

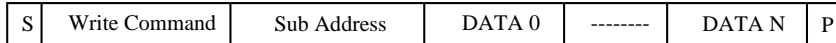
- S Start condition
- Slave Address Slave receiver is act transmitter is ad
- A Acknowledge, generated by the slave
- Sub Address N Sub Address byte
- DATA N DATA byte of Register N
- DATA N + 1 DATA byte of Register N + 1 (address auto-increment)
- AM Acknowledge, generated by the micro controller
- P Stop condition (When Last AM must be '1' )



[SPI-BUS]

<SPI-Bus Format>

WRITE MODE

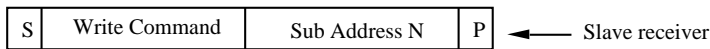


40(hex) or 1E(hex)

if more than 1byte DATA is transmitted,  
then auto-increment of the Sub Address is performed

- S                    Chip select on (Hi to Lo)
- Write Command    40(hex) or 1E(hex)
- Sub Address        Sub address byte
- DATA 0            First data byte
- DATA N            continued data byte(Sub Address is auto increment)
- P                    Chip select off (Lo to Hi)

READ MODE



40(hex) or 1E(hex)

then



41(hex) or 1F(hex)

- S                    Chip select on (Hi to Lo)
- Sub Address N     Sub Address byte set
- Read Command    41(hex) or 1F(hex)
- DATA N            DATA byte of Register N
- DATA N + 1        DATA byte of Register N + 1 (address auto-increment)
- P                    Chip select off (Lo to Hi)





**[Register Mapping and Description]**

Sub-address 70 : Variable I/O Switch (write/read)

	MSB							LSB
Register 70	bs-off	self-SW	color bar select	VBLK SW	EXTsync SW	F/Vsync SW	M/S mode1	M/S mode0
	default : 0000_0001(bin)							

bs - off : color burst control switch On/Off  
 0 : color burst ON (default)  
 1 : color burst OFF

self - SW : internal self H/V counter reset switch On / Off  
 0 : self counter reset OFF (default)  
 1 : self counter reset ON  
 Note : this mode is ONLY valid at when 70h[1: 0] is "10(bin)" or "11(bin)".

color bar select : color bar select

	Luma	Chroma
0 : color bar	100%	100%
1 : color bar	100%	75%

VBLK SW : Vertical Blanking Mask Enabale switch On-Off  
 0 : reject VBI information data in vertical blanking period (default)  
 1 : through VBI information data in vertical blanking period

EXTsync SW : Composite sync/Flame sync output switch  
 0 : Frame sync output (default)  
 1 : compsite sync output

F/Vsync SW : Flame sync /Vertical sync output switch  
 0 : Vertical sync output (default)  
 1 : Frame sync output

M/S sync mode1 : Master or Slave sync mode  
 M/S sync mode0 : 00 : 656 slave or H/V master mode  
 01 : 656 slave mode(no H/Vsync output) (default)  
 10 : Fsync/Hsync slave mode  
 11 : Vsync/Hsync slave mode



Sub-address 71 : Sync control (write/read)

	MSB							LSB
Register 71	non-inter	VBI SW	h-polarity	v-polarity	f-polarity	h- delay2	h-delay1	h-delay0

default : 0000\_0100(bin)

- non-inter : non-interlaced mode select  
0 : interlace mode (default)  
1 : non-interlace mode
- VBI SW : vertical blanking information signal input control switch on EXT pin  
0 : VBI input Off (default)  
1 : VBI input On
- h-polarity : polarity of Hsync  
0 : negative (default)  
1 : positive
- v-polarity : polarity of Vsync  
0 : negative (default)  
1 : positive
- f-polarity : polarity of Fsync  
0 : field1 (odd) = low level (default)  
1 : field1 (odd) = high level
- h-delay2 : delay on Hsync with referance to DVIN data in Master mode
- h-delay1 : 000: + 4 clock delay
- h-delay0 : 001: + 3 clock delay  
010: + 2 clock delay  
011: + 1 clock delay  
100: + 0 clock delay  
101: - 1 clock delay  
110: - 2 clock delay  
111: - 3 clock delay

Note : this h-delay can be also related with 7A[7:0] register and can delay totally +2023 clock delay in H/V or H/Fsynnc slave mode.



Sub-address 72 : PAL/NTSC setup (write / read)

	MSB							LSB
Register 72	phase-set	TEST	EXT I/O SW	color bar	setup75	625/525	PAL/NTSC2	PAL/NTSC1

default : 0000\_1000(bin) NTSC (If "PAL/NTSC" pin is LOW level)  
 0000\_0101(bin) PAL

phase-set : color sub-carrier phase synchronization  
 0 : free running (default)  
 1 : 1 phase reset/8 field and 1 phase reset/4 flam

TSET : for test, should be "0"

EXT I/O SW : Input/Output switch on EXT pin  
 0 : VBI input(default)  
 1 : Csync or Flame sync output

color bar : internal color bar generator control  
 0 : nomal operation (default)  
 1 : color bar generator On  
 (need to set color bar mode on sub-address 70[5]. )

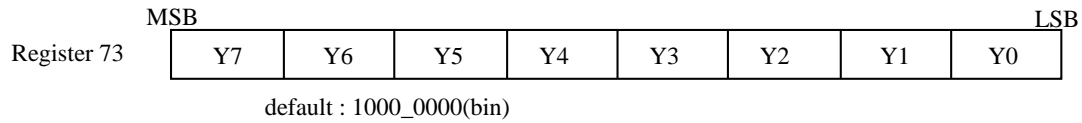
setup75 : Setup level for Luminance  
 0 : setup level for luminunce = 0IRE  
 1 : setup level for luminunce = 7.5IRE

625/525 : control line mode  
 0 : 525 lines / 60 Hz mode  
 1 : 625 lines / 50 Hz mode

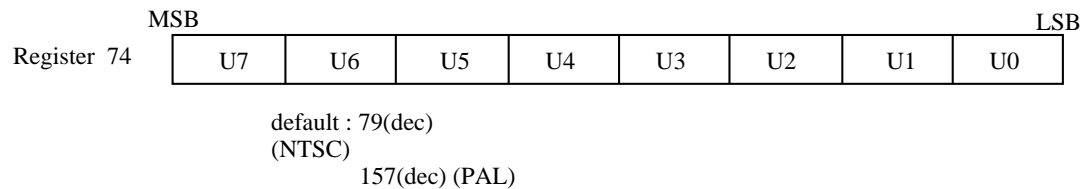
PAL/NTSC2 : subcarrier control  
 PAL/NTSC1  
 00 : NTSC(M)  
 01 : PAL (BDGHI)  
 10 : PAL (M)  
 11 : PAL (N)



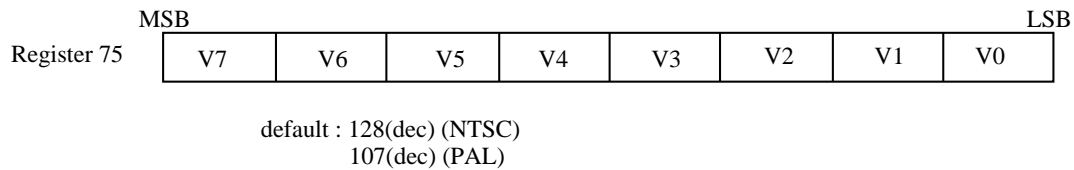
Sub-address 73: Vertical Blanking Information Luma (Y) Level (write only)

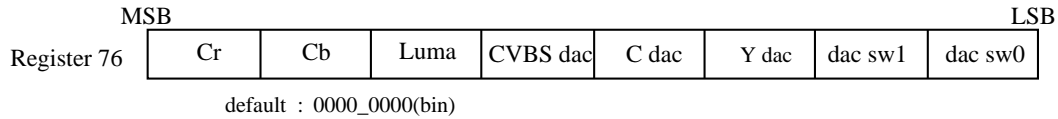


Sub-address 74: Vertical Blanking Information Chroma (U) Level (write only)

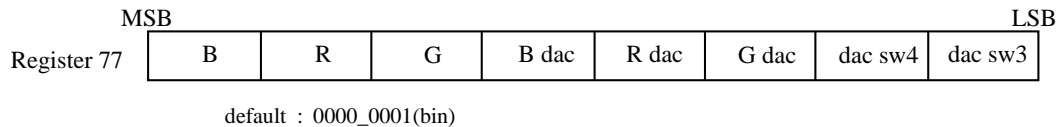


Sub-address 75: Vertical Blanking Information Chroma (V) Level (write only)



Sub-address 76 : signal control 1(write only)

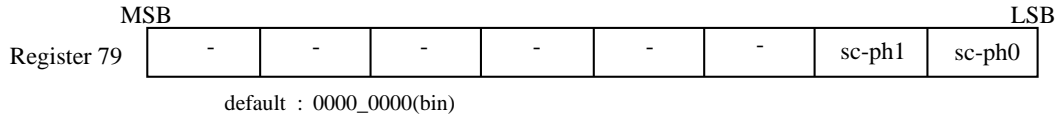
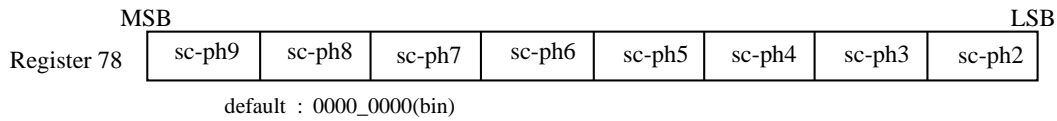
- Cr : Cr/Cb signal control  
 Cb : 0 : Cr, Cb On (default)  
       1 : chrominance Off
- Luma : luminance control  
       0 : luminance On (default)  
       1 : luminance Off
- CVBSdac : D/A converter (1) output On-Off control  
 Cdac : 0 : CVBS/Cb/BDAC1, C/Cr/RDAC1, Y/GDAC1 output On (default)  
 Ydac : 1 : CVBS/Cb/BDAC1, C/Cr/RDAC1, Y/GDAC1 output Off
- dac sw1 : 1~9-pin's D/A converter output signal control  
 dac sw0 : 01 or 11 : R/G/B output On  
           10 : Y/Cr/Cb output On  
           00 : Y/C/CVBS output On

Sub-address 77 : signal control 2 (write only)

- B : B/R/G signal control  
 R : 0 : B/R/G signal On (default)  
 G : 1 : B/R/G signal Off
- Bdac : D/A converter (2) output On-Off control  
 Rdac : 0 : CVBS/Cb/BDAC2, C/Cr/RDAC2, Y/GDAC2 output On (default)  
 Gdac : 1 : CVBS/Cb/BDAC2, C/Cr/RDAC2, Y/GDAC2 output Off
- dac sw4 : 17~25-pin's D/A converter (2) output signal control  
 dac sw3 : 01 or 11 : R/G/B output On (default)  
           10 : Y/Cr/Cb output On  
           00 : Y/C/CVBS output On

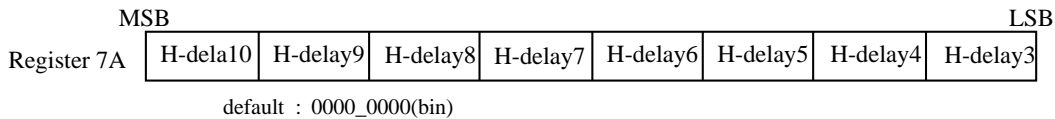


Sub-address 78~79 : Sub-carrier phase control (write only)



sc-ph9 : sub-carrier phase control  
 sc-ph8 0000\_0000 : sub-carrier phase 0 degree (default)  
 sc-ph7 to  
 sc-ph6 1111\_1111 : sub-carrier phase 359 degree  
 sc-ph5  
 sc-ph4  
 sc-ph3  
 sc-ph2  
 sc-ph1  
 sc-ph0

Sub-address 7A : Hsync delay control (write only)



h-delay10 : delay on Hsync with reference to DVIN data  
 h-delay9 0000\_0000\_000 : Hsync delay 0 delay  
 h-delay8 to  
 h-delay7 1111\_1111\_000 : Hsync delay +255 delay  
 h-delay6  
 h-delay5  
 h-delay4  
 h-delay3

Note : this h-delay can be also related with 71[3:0] register and can delay totally +2023 delay(1111\_1111\_111) in H/V or H/ Fsync slave mode.



Sub-address 7B : Digital Video Input Select Control (write only)

	MSB							LSB
Register 7B	-	-	Cr_tmg 2	Cr_tmg1	Cb_tmg 2	Cb_tmg1	Y_tmg	16-bit input mode

default : 0000\_0000(bin)

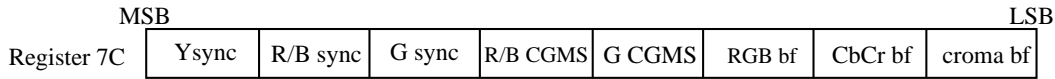
Cr/Cb\_tmg2 : Cr/Cb clock timing delay in 16-bit Digital Input Mode  
 Cr/Cb\_tmg1 : 00 : Cr clock delay 0 clock (default)  
                   01 : Cr clock delay +1 clock  
                   10 : Cr clock delay +2 clock  
                   11 : Cr clock delay +3 clock

Y\_tmg : Y clock timing delay in 16-bit Digital Input Mode  
 0 : Y clock delay 0 clock (default)  
 1 : Y clock delay +1 clock

16-bit input mode : 16-bit Multiplexed CbYCrY Digital Video Input mode  
 0 : 8-bit CbYCrY Digital Video Input mode (default)  
 1 : 16-bit CbYCrY Digital Video Input mode



Sub-address 7C : signal control 3(write only)



default : 0000\_0000(bin)

Y sync : Y sync Signal On/Off (Y/Cb/Cr mode only)  
 0 : Y sync On (default)  
 1 : Y sync Off

R/B sync : R/B sync signal On/Off  
 0 : R/B sync Off (default)  
 1 : R/B sync On

G sync : G sync signal On/Off  
 0 : G sync Off (default)  
 1 : G sync On

R/B CGMS : R/B CGMS data Insertion On/Off  
 0 : CGMS data On  
 1 : CGMS data off

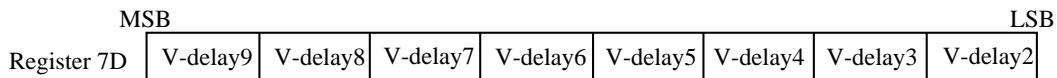
G CGMS : G CGMS data Insertion On/Off  
 0 : CGMS data On  
 1 : CGMS data off

RGB bf : RGB burst level On/Off  
 0 : RGB bf data On  
 1 : RGB bf data off

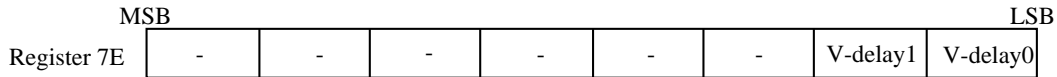
CbCr bf : CbCr burst On/Off  
 0 : Cb/Cr bf data On  
 1 : Cb/Cr bf data off

Croma : Croma burst On/Off  
 0 : Croma bf data On  
 1 : Croma bf data off

Sub-address 7D~7E : Vsync delay control (write only)



default : 0000\_0000(bin)



default : 0000\_0000(bin)



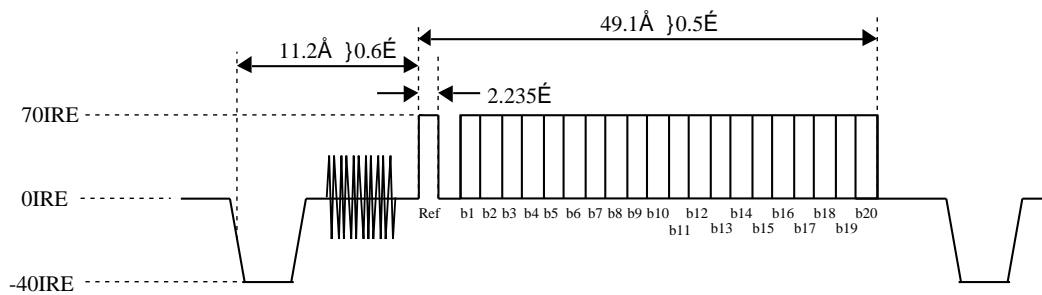
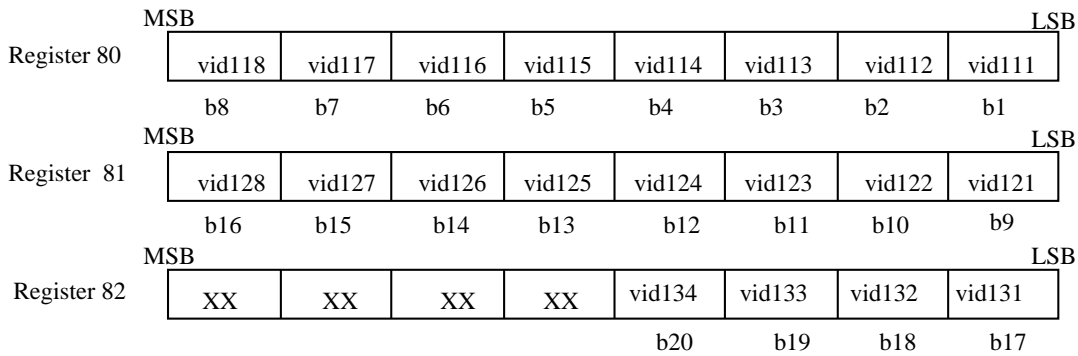


V-delay9 : delay on Vsync with reference to DVIN data in slave mode  
V-delay8 0000\_0000\_000 : Vsync delay 0 delay  
V-delay7 to  
V-delay6 1111\_1111\_111 : Hsync delay +1023 delay  
V-delay5  
V-delay4  
V-delay3  
V-delay2  
V-delay1  
V-delay0



Sub-address 80~82: CGMS characters for Field1(Line20)/Field2(Line283) (write only)

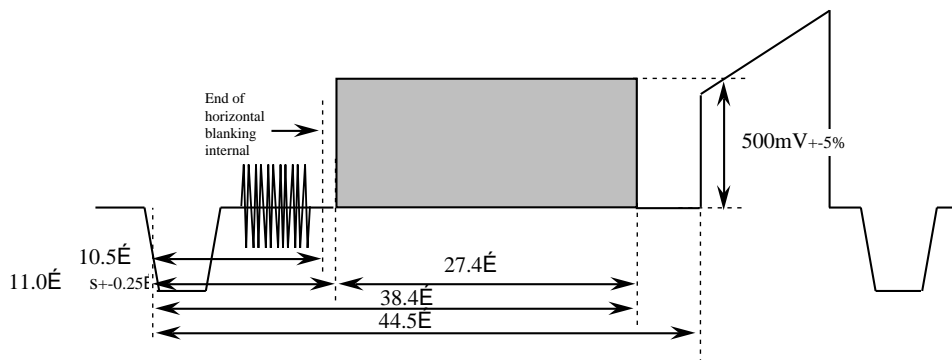
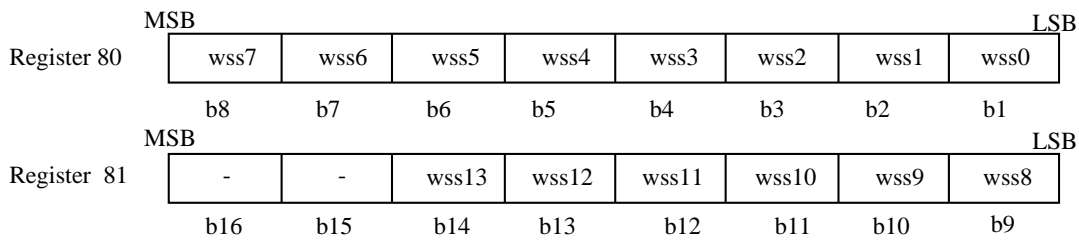
NTSC only



**Fig 18 : CGMS wave form**

Sub-address 80~81: WSS characters for Line23 (write only)

PAL only



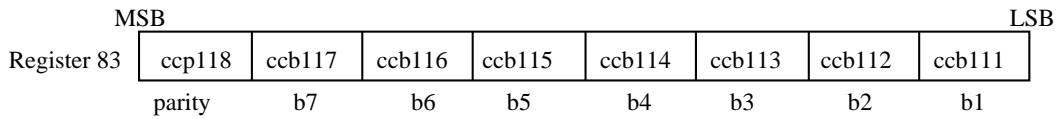
**Fig 19 : WSS wave form**



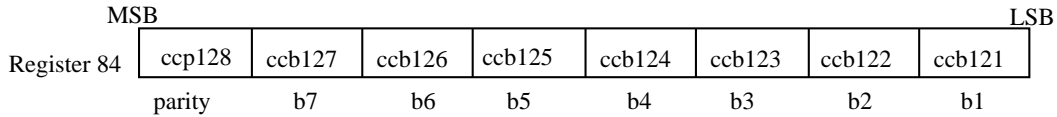
Sub-address 83~84 :closed caption characters/extended data for Field1(Line21) (write)

default 1000\_0000

First byte to Encode

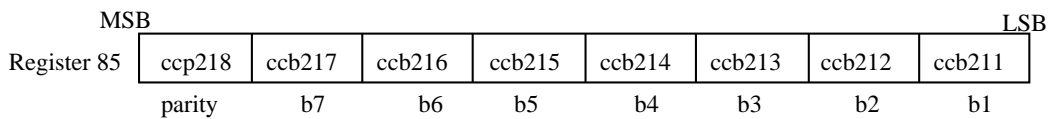


Second byte to Encode

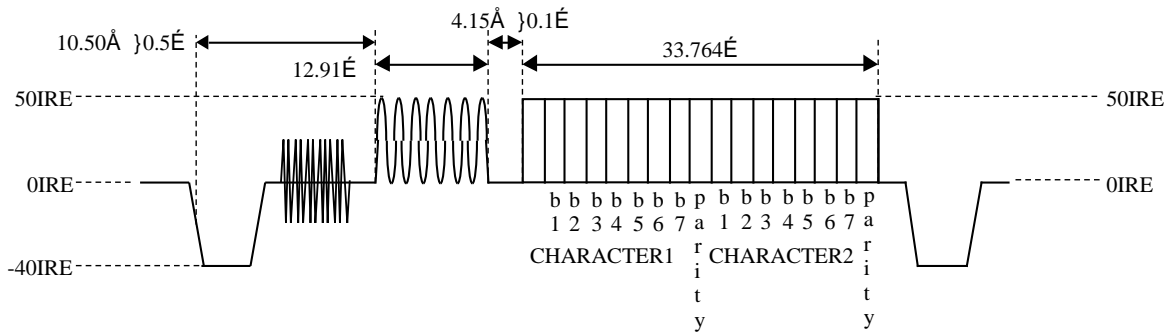
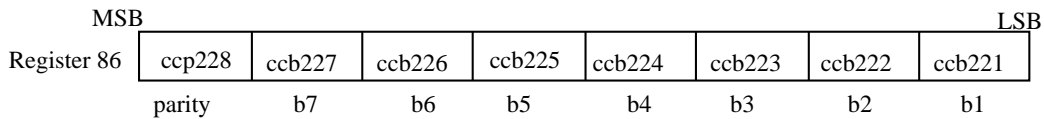


Sub-address 85~86 :closed caption character/extended data for Field2(Line284)

First byte to Encode

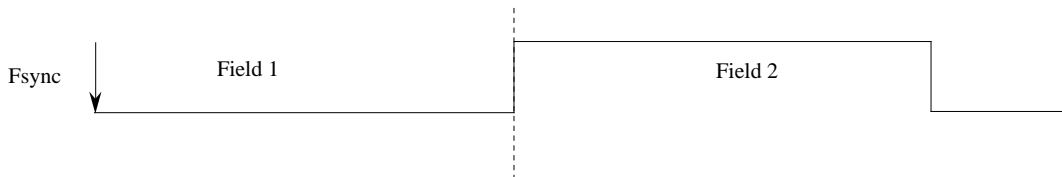


Second byte to Encode



**Fig 20 : Closed caption wave form**

sub-address 83 & 84 and 85 & 86 (previous frame data) are double-buffered by Flame sync falling edge



**Fig 21 : Closed caption data update timing**



Sub-address 87 :Closed caption/CGMS

	MSB								LSB
Register 87	CC2_flag	CC1_flag	CC_null	-	WSS	CGMS	CC2	CC1	

default 00h

CC2\_flag : Closed Caption Status Flag for field2/field1

CC1\_flag : 00 : Automatically set to " 11 " at when 2-byte Closed Caption data are written, and then will be cleared to "00" when the data is send to doubled buffer

CC\_null : Automatically set the null code when the data is send to doubled buffer

- 0 : Keep data registers
- 1 : Automatically set the null code

WSS : WSS information data insertion On-Off  
0 : WSS information data insertion Off  
1 : WSS information data insertion On

CGMS : CGMS information data insertion On-Off  
0 : CGMS information data insertion Off  
1 : CGMS information data insertion On

CC2 : closed caption/extended data for field2 encoding On-Off  
0 : closed caption/extended data for field2 encoding Off  
1 : closed caption/extended data for field2 encoding On

CC1 : closed caption/extended data for field1 encoding  
0 : closed caption/extended data for field1 encoding Off  
1 : closed caption/extended data for field1 encoding On



I2C-BUS Slave Receiver Sub-address map

70h:[7]	burst control (default 0:on)	77h[7:5]	B/R/G signal control (default 0: On)
[6]	self counter reset switch (default 0:off)	[4:2]	D/A converter(2) output On/Off control(default 0: On)
[5]	color bar select (default 0:Luma 100% Chroma 100%)	[1:0]	D/A converter(2) output signal control(default 0X: On)
[4]	vertical blanking switch(default 0:off)		
[3]	EXT pin output mode select (Csync:1, Flame sync:0)	78h[7:0]	sub-carrier phase control(default 00h)
[2]	F/Vsync select(default 0:Vsync)	79h[1:0]	sub-carrier phase control(default 00)
[1:0]	Master/Slave mode select(default 01:656_slave)	79h[7:2]	n.a.
71h:[7]	interlaced / non-interlaced (default 0:interlaced)	7A[7:0]	hsync-delay control (In slave mode, is valid with 71h[2:0] register)
[6]	VBI input control on EXT pin (default 0:off)		n.a
[5]	horizontal sync polarity (default 0)	7B[7:6]	Cr/Cb clock timing delay in 16-bit digital input mode (default 00: clock delay 0)
[4]	vertical sync polarity (default 0)	[5:2]	Y clock timing delay in 16-bit digital input mode (default 0: clock delay 0)
[3]	flame sync polarity (default 0)	[1]	16-bit multiplexed CbYCrYdigital video input mode (default 0: 8-bit YCrCb digital video input mode)
[2:0]	hsync delay control (default 100:0 clock delay) (In slave mode can use with 7A[7:0])	[0]	Ysync signal On/Off(YCrCb mode only)(default 0: On)
72h:[7]	sub-carrier phase syncronaiaition(default 0)		R/Bsync signal On/Of(default 0: Off)
[6]	Test mode (default 0:off)	7C[7]	Gsync signal On/Of(default 0: Off)
[5]	EXT I/O switch(default 1:cysnc output)	[6]	R/B CGMS data insertion On/Of(default 0: On)
[4]	color bar generate(default 0:off)	[5]	G CGMS data insertion On/Of(default 0: On)
[3]	setup level control(default 1:7.5IRE)	[4]	RGB/CbCr burst On/Off(default 0: On)
[2]	625lines50Hz/525Lines60Hz (default set PAL/NTSC pin)	[3]	Chroma burst On/Off(default 0: On)
[1:0]	PAL/NTSC (default set PAL/NTSC pin)	[2:1]	
	00:NTSC/M	[0]	
	01:PAL/BGHL		
	(10:PAL/M) (11:PAL/N)	7D[7:0]	delay on Vsync with reference to DVIN data in slave mode
73h[7:0]	Y_register(default 80h)		n.a
74h[7:0]	U_register(default 79d:ntsc/157d:PAL)	7E[7:2]	delay on Vsync with reference to DVIN data in slave mode
75h[7:0]	V_register(default 128d:ntsc/107d:PAL)	[1:0]	
76h[7]	Cr on/off (default 0:on)		
[6]	Cb on/off (default 0:on)		
[5]	Luma on/off(default 0:on) (default 0: on)	80~82h	CGMS characters for field1(line20)/field2(line283)
[4:2]	CVBS dac/Cdac/Ydac on/off(default 0: on)	80~81h	WSS characters for field1(line23)
[1:0]	D/A converter output signal control (default 00 : CBVS/Y/C output)	83h[7:0]	CC character1(line21) (default 'h80)
		84h[7:0]	CC character2(line21) (default 'h80)
		85h[7:0]	CC character1(line284) (default 'h80)
		86h[7:0]	CC character2(line284) (default 'h80)
		87h[7:6]	Closed Caption Status Flag for field2
		[5]	Automatic set to null code(Closed Caption data)
		[4]	n.a.
		[3]	WSS information data insetion on/off (default 0: off)
		[2]	CGMS on/off (default 0: off)
		[1]	CC closed caption/extended data for field2 encoding (default 0: off)
		[0]	CC closed caption/extended data for field1 encoding (default 0: off)

\*\*\*\*\* M-BUS Format \*\*\*\*\*

\*\* WRITE MODE \*\*

S | Slave\_address(W) | A | Sub\_address | A | Data0 | A | ... | DataN | A | P

S Start condition  
Slave\_address 42(hex) or 1C(hex)  
A Acknowledge generated by me  
Sub\_address Sub\_address register  
Data0 First data  
DataN Continued data(address is auto incremented)  
P Stop condition

\*\*\*\*\* SPI-Bus Format \*\*\*\*\*

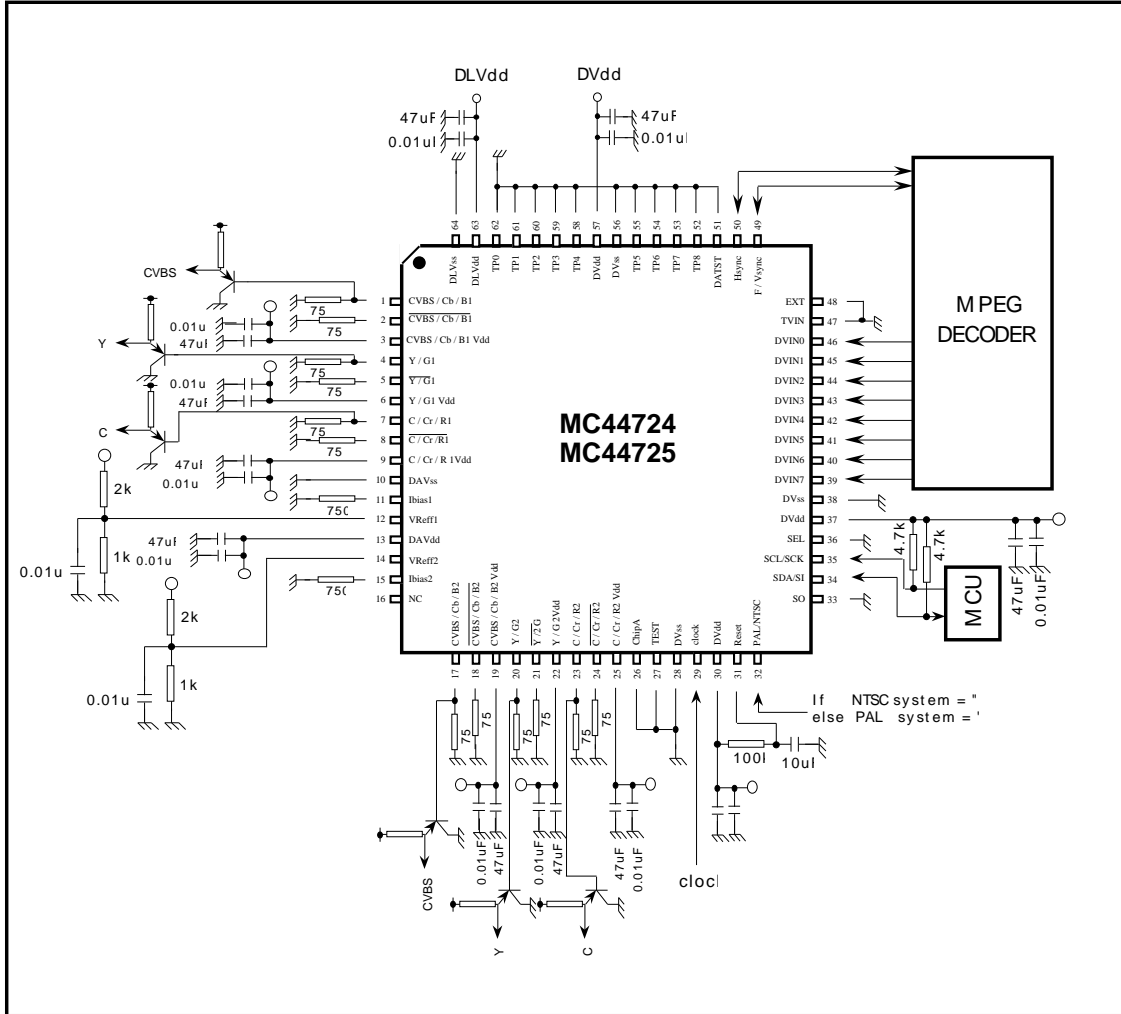
\*\* WRITE MODE \*\*

S | Write Command | Sub\_address | Data0 | ... | DataN | P

S Chip select on (High to Low)  
Write Command 42(hex) or 1C(hex)  
Sub\_address Sub\_address byte  
Data0 First data  
DataN Continued data byte(address is auto incremented)  
P Chip select off (Low to High)

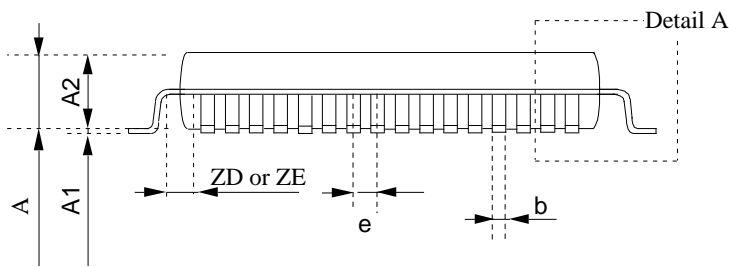
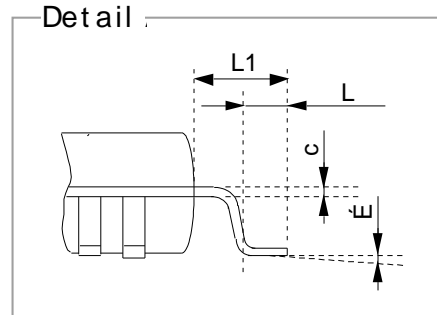
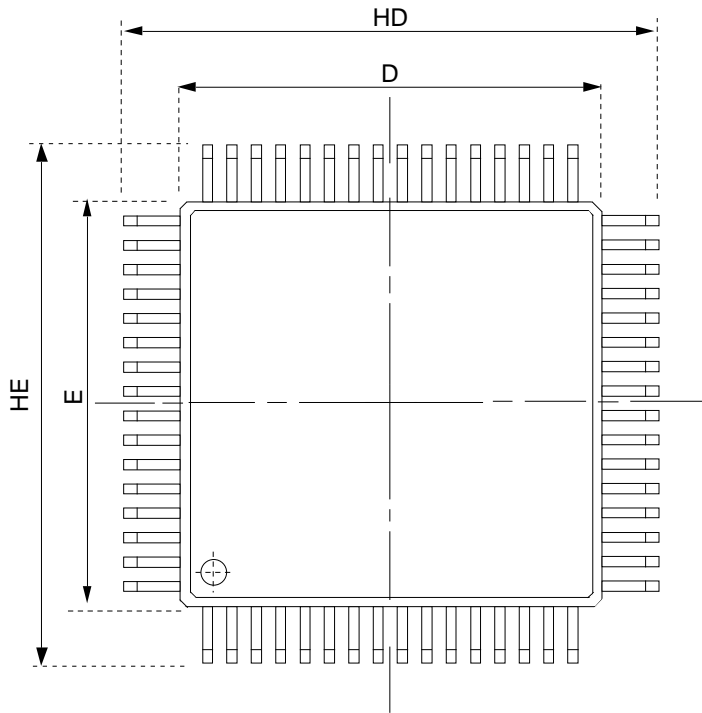


[ Application Diagram





Package



	min	max
A	-	1.70
A1	0.05	0.15
A2	1.40TYP	
b	0.18	0.27
c	0.10	0.20
D	9.90	10.1
E	9.90	10.1
e	0.50	
HD	11.80	12.20
HE	11.80	12.20
L	0.50TYP	
L1	0.80	1.20
É	0	10
y	-	0.10
ZD	1.25TYP	
ZE	1.25TYP	

unit : m