

DS7820/DS8820 Dual Line Receiver

General Description

The DS7820, specified from -55°C to $+125^{\circ}\text{C}$, and the DS8820, specified from 0°C to $+70^{\circ}\text{C}$, are digital line receivers with two completely independent units fabricated on a single silicon chip. Intended for use with digital systems connected by twisted pair lines, they have a differential input designed to reject large common mode signals while responding to small differential signals. The output is directly compatible with TTL or LS integrated circuits.

The response time can be controlled with an external capacitor to eliminate noise spikes, and the output state is determined for open inputs. Termination resistors for the twisted pair line are also included in the circuit. Both the DS7820 and the DS8820 are specified, worst case, over their full operating temperature range, for ± 10 -percent supply voltage variations and over the entire input voltage range.

Features

- Operation from a single +5V logic supply
- Input voltage range of $\pm 15\text{V}$
- Each channel can be strobed independently
- High input resistance
- Fan out of two with TTL integrated circuits
- Strobe low forces output to "1" state

Connection Diagram

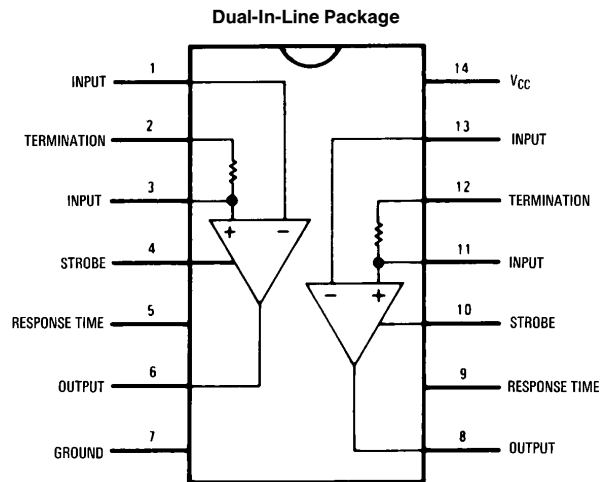

TL/F/5796-2

Top View

Order Number DS7820J or DS8820N
See NS Package Number J14A or N14A

For Complete Military 883 Specifications, See RETS Data Sheet.
Order Number: DS7820J/883 or DS7820W/883
See NS Package Number J14A or W14B

Absolute Maximum Ratings (Note 1)

If Military/Aerospace specified devices are required, please contact the National Semiconductor Sales Office/Distributors for availability and specifications.

Supply Voltage	8.0V
Input Voltage	± 20V
Differential Input Voltage	± 20V
Strobe Voltage	8.0V
Output Sink Current	25 mA
Storage Temperature Range	−65°C to +150°C
Lead Temperature (Soldering, 4 sec.)	260°C

Maximum Power Dissipation* at 25°C

Cavity Package	1308 mW
Molded Package	1207 mW

*Derate cavity package 8.7 mW/°C above 25°C; derate molded package 9.7 mW/°C above 25°C.

Operating Conditions

	Min	Max	Units
Supply Voltage (V_{CC})			
DS7820	4.5	5.5	V
DS8820	4.75	5.25	V
Temperature (T_A)			
DS7820	−55	+125	°C
DS8820	0	+70	°C

Electrical Characteristics (Notes 2 and 3)

Symbol	Parameter	Conditions	Min	Typ	Max	Units
V_{TH}	Input Threshold Voltage	$V_{CM} = 0V$	−0.5	0	0.5	V
		$-15V \leq V_{CM} \leq 15V$	−1.0	0	1.0	V
V_{OH}	High Output Level	$I_{OUT} \leq 0.2 \text{ mA}$	2.5		5.5	V
V_{OL}	Low Output Level	$I_{SINK} \leq 3.5 \text{ mA}$	0		0.4	V
R_{I^-}	Inverting Input Resistance		3.6	5.0		k Ω
R_{I^+}	Non-Inverting Input Resistance		1.8	2.5		k Ω
R_T	Line Termination Resistance	$T_A = 25^\circ\text{C}$	120	170	250	Ω
t_r	Response Time	$C_{DELAY} = 0 \text{ pF}$		40		ns
		$C_{DELAY} = 100 \text{ pF}$		150		ns
I_{ST}	Strobe Current	$V_{STROBE} = 0.4V$		−1.0	−1.4	mA
		$V_{STROBE} = 5.5V$			5.0	μA
I_{CC}	Power Supply Current	$V_{IN} = 15V$		3.2	6.0	mA
		$V_{IN} = 0V$		5.8	10.2	mA
		$V_{IN} = -15V$		8.3	15.0	mA
I_{IN^+}	Non-Inverting Input Current	$V_{IN} = 15V$		5.0	7.0	mA
		$V_{IN} = 0V$	−1.6	−1.0		mA
		$V_{IN} = -15V$	−9.8	−7.0		mA
I_{IN^-}	Inverting Input Current	$V_{IN} = 15V$		3.0	4.2	mA
		$V_{IN} = 0V$		0	−0.5	mA
		$V_{IN} = -15V$	−4.2	−3.0		mA

Note 1: "Absolute Maximum Ratings" are those values beyond which the safety of the device cannot be guaranteed. Except for "Operating Temperature Range" they are not meant to imply that the devices should be operated at these limits. The table of "Electrical Characteristics" provides conditions for actual device operation.

Note 2: These specifications apply for $4.5V \leq V_{CC} \leq 5.5V$, $-15V \leq V_{CM} \leq 15V$ and $-55^\circ\text{C} \leq T_A \leq +125^\circ\text{C}$ for the DS7820 or $0^\circ\text{C} \leq T_A \leq +70^\circ\text{C}$ for the DS8820 unless otherwise specified; typical values given are for $V_{CC} = 5.0V$, $T_A = 25^\circ\text{C}$ and $V_{CM} = 0$ unless stated differently.

Note 3: All currents into device pins shown as positive, out of device pins as negative, all voltages referenced to ground unless otherwise noted. All values shown as max or min on absolute value basis.

Note 4: The specifications and curves given are for one side only. Therefore, the total package dissipation and supply currents will be double the values given when both receivers are operated under identical conditions.

Typical Performance Characteristics (Note 3)

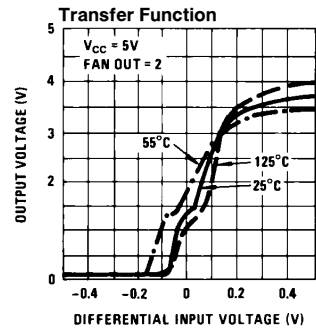
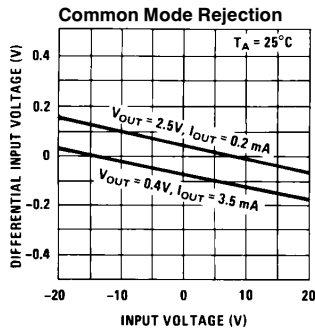
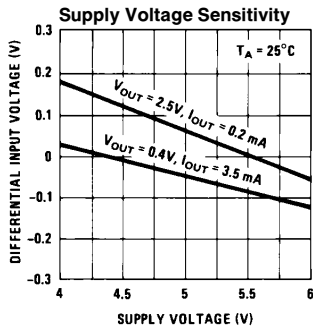

TL/F/5796-4

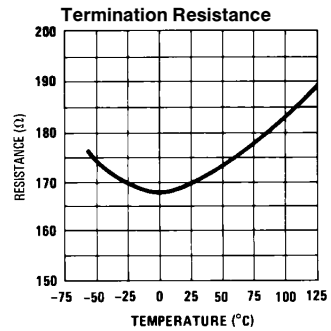
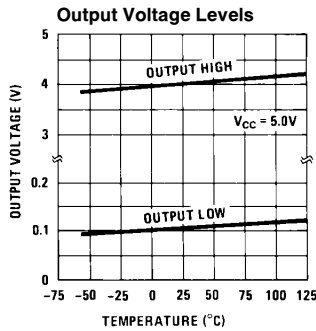
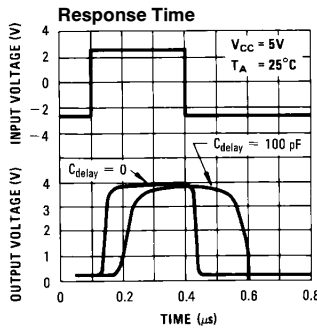

TL/F/5796-5

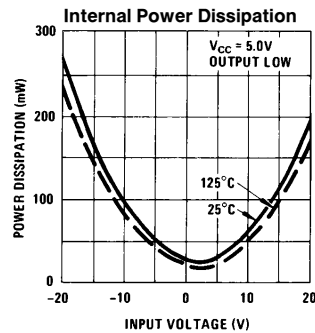
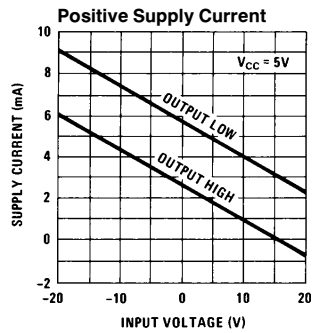

TL/F/5796-6

Typical Application

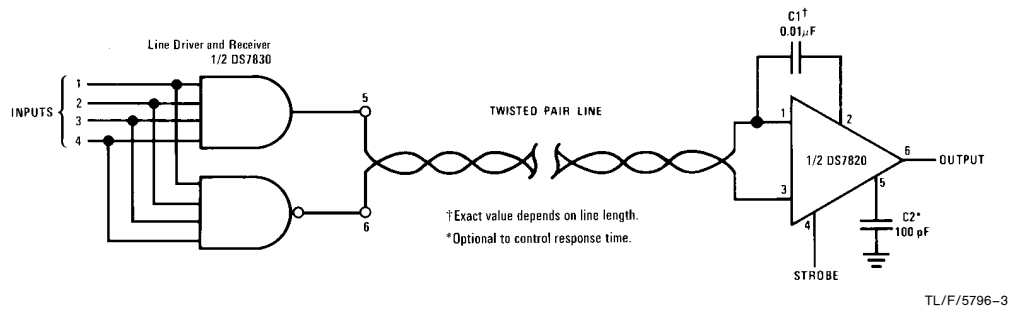

Schematic Diagram

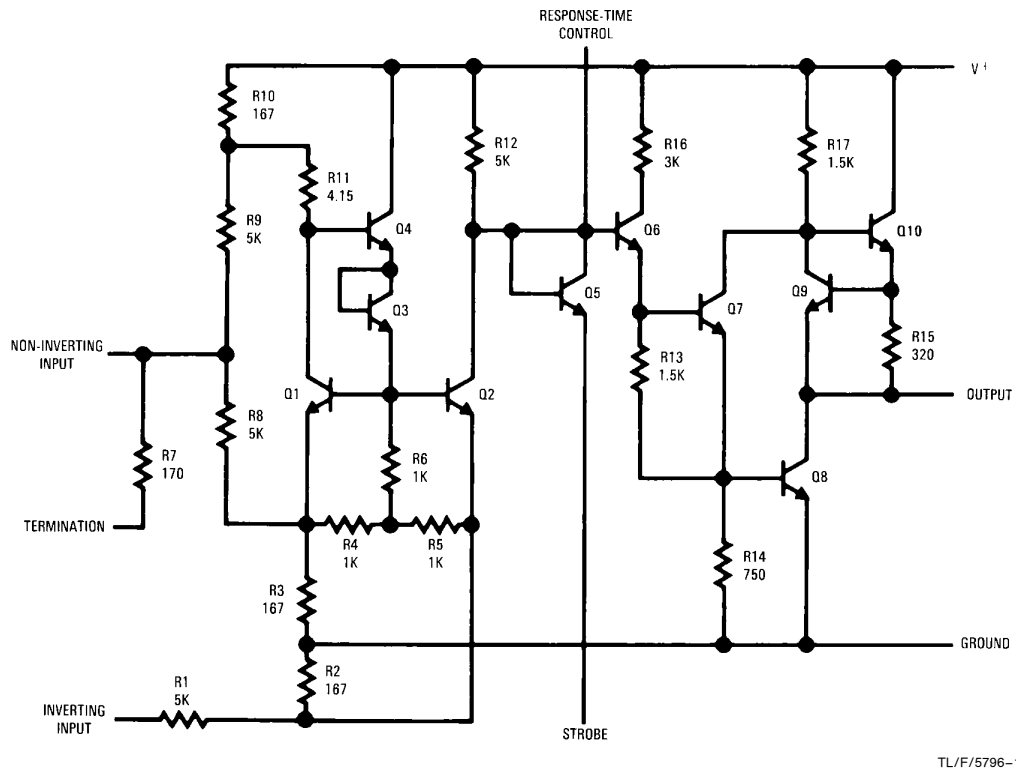

Physical Dimensions inches (millimeters)

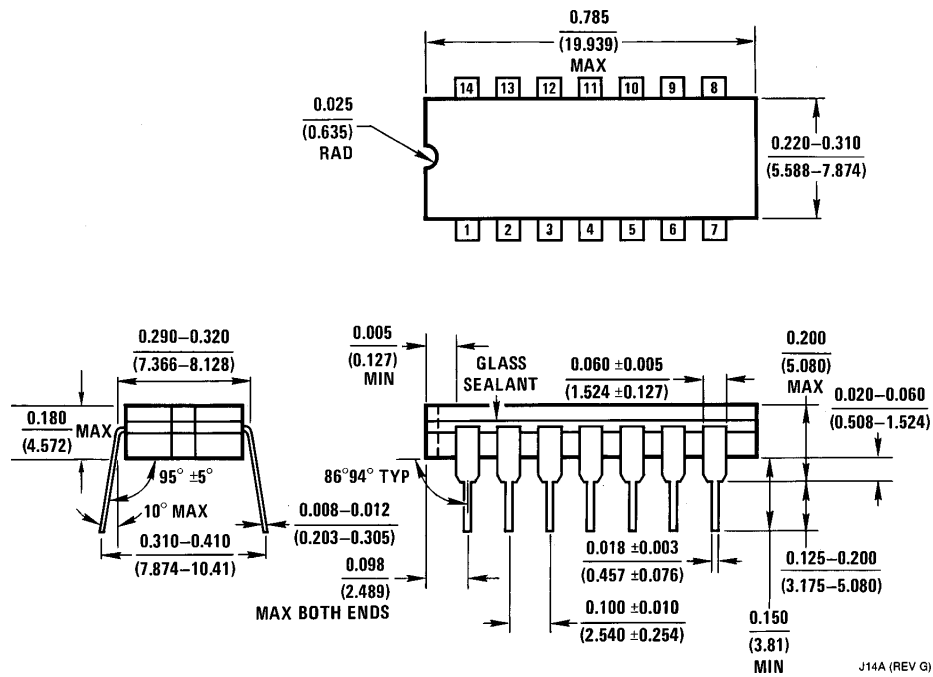

Ceramic Dual-In-Line Package (J)
Order Number DS7820J
NS Package Number J14A

J14A (REV G)

Physical Dimensions inches (millimeters) (Continued)

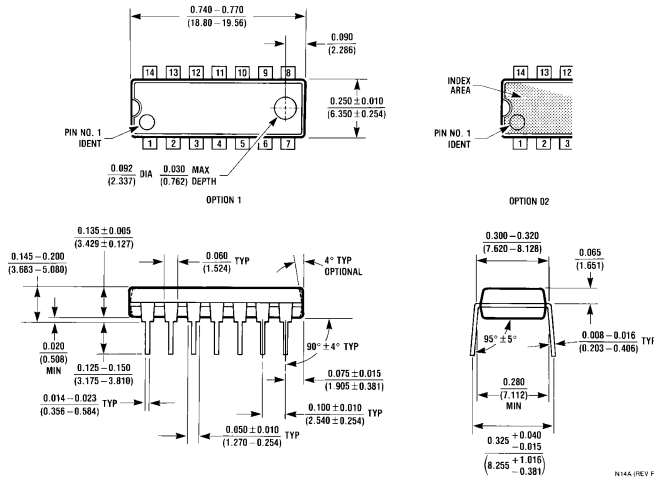

Molded Dual-In-Line Package (N)
Order Number DS8820N
NS Package Number N14A

LIFE SUPPORT POLICY

NATIONAL'S PRODUCTS ARE NOT AUTHORIZED FOR USE AS CRITICAL COMPONENTS IN LIFE SUPPORT DEVICES OR SYSTEMS WITHOUT THE EXPRESS WRITTEN APPROVAL OF THE PRESIDENT OF NATIONAL SEMICONDUCTOR CORPORATION. As used herein:

1. Life support devices or systems are devices or systems which, (a) are intended for surgical implant into the body, or (b) support or sustain life, and whose failure to perform, when properly used in accordance with instructions for use provided in the labeling, can be reasonably expected to result in a significant injury to the user.
2. A critical component is any component of a life support device or system whose failure to perform can be reasonably expected to cause the failure of the life support device or system, or to affect its safety or effectiveness.

 <p>National Semiconductor Corporation 1111 West Bardin Road Arlington, TX 76017 Tel: 1(800) 272-9959 Fax: 1(800) 737-7018 http://www.national.com</p>	<p>National Semiconductor Europe</p> <p>Fax: +49 (0) 180-530 85 86 Email: europe.support@nsc.com Deutsch Tel: +49 (0) 180-530 85 85 English Tel: +49 (0) 180-532 78 32 Français Tel: +49 (0) 180-532 93 58 Italiano Tel: +49 (0) 180-534 16 80</p>	<p>National Semiconductor Hong Kong Ltd. 19th Floor, Straight Block, Ocean Centre, 5 Canton Rd. Tsimshatsui, Kowloon Hong Kong Tel: (852) 2737-1600 Fax: (852) 2736-9960</p>	<p>National Semiconductor Japan Ltd. Tel: 81-043-299-2308 Fax: 81-043-299-2408</p>
---	--	---	---

National does not assume any responsibility for use of any circuitry described, no circuit patent licenses are implied and National reserves the right at any time without notice to change said circuitry and specifications.

This datasheet has been download from:

www.datasheetcatalog.com

Datasheets for electronics components.