

EVALUATION KIT
AVAILABLE

MAXIM

+2.8V, Single-Supply, Cellular-Band Linear Power Amplifier

MAX2251

General Description

The MAX2251 low-voltage linear power amplifier (PA) is designed for TDMA/AMPS dual-mode phone applications. The device is packaged in an ultra-compact (2.06mm × 2.06mm) chip-scale package (CSP), and delivers over +30dBm of linear power in TDMA operation. An on-chip shutdown feature reduces operating current to 1μA (typ), eliminating the need for an external supply switch.

The MAX2251 does not need an external reference voltage, and requires only a few external matching components and no bias circuitry. Another feature of this device is the use of external bias resistors, eliminating wasted "safety-margin" current. This feature also allows current throttleback at lower output power levels, thereby maintaining the highest possible efficiency at all power levels.

Applications

Cellular-Band TDMA/AMPS Dual-Mode Phones
PA Modules
2-Way Pagers
Cordless Phones

Features

- ◆ Ultra-Compact 4 × 4 (2.06mm × 2.06mm) CSP
- ◆ High Efficiency—41% at +30dBm P_{OUT} (TDMA) (typ)
- ◆ On-Chip Power Detector
- ◆ I_{CC} < 1μA in Shutdown Mode
- ◆ +2.8V to +4.5V True Single-Supply Operation
- ◆ ±0.9dB Gain Variation from T_A = -40°C to +85°C
- ◆ Current Adjustable with PDM or DAC Signal
- ◆ No External Logic Interface Circuitry Required

Ordering Information

PART	TEMP RANGE	PIN-PACKAGE	TOP MARK
MAX2251EBE	-40°C to +85°C	4 × 4 UCSP	2251 EBE --- (LOT #) --- (DATE CODE)

Typical Operating Circuit appears at end of data sheet.

Pin Configuration

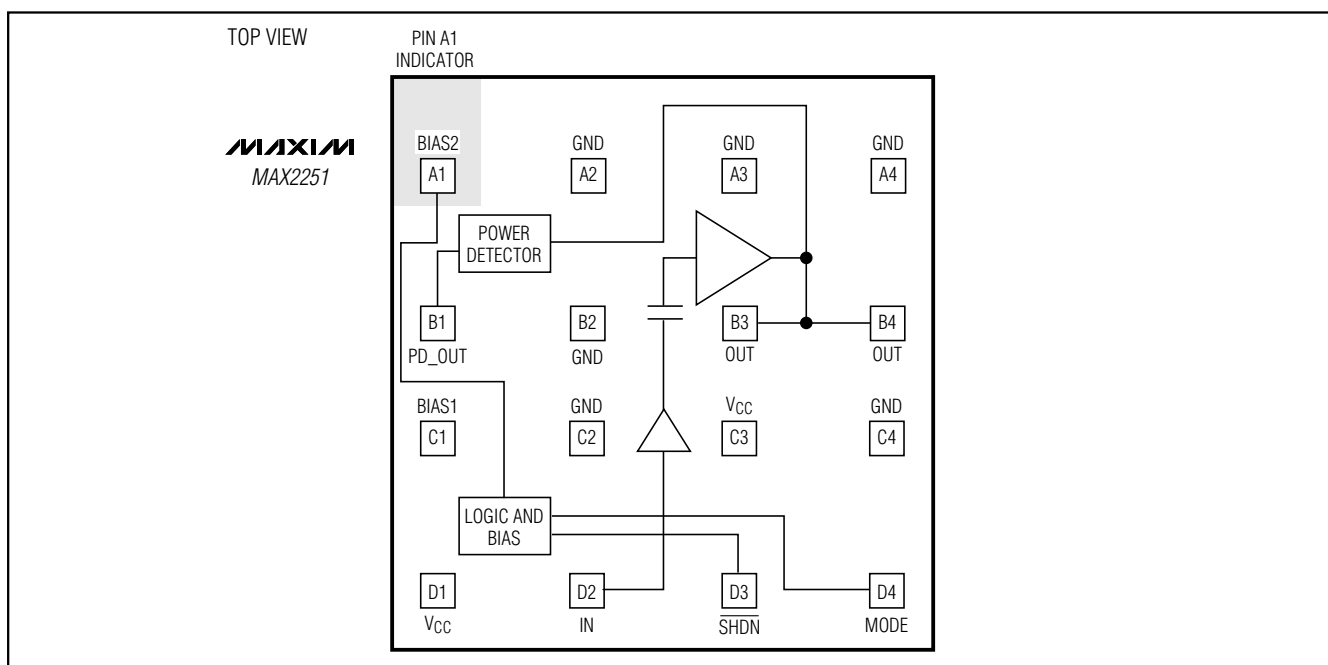

MAXIM

Maxim Integrated Products 1

For price, delivery, and to place orders, please contact Maxim Distribution at 1-888-629-4642, or visit Maxim's website at www.maxim-ic.com.

+2.8V, Single-Supply, Cellular-Band Linear Power Amplifier

ABSOLUTE MAXIMUM RATINGS

V _{CC} to GND	-0.3V to +4.5V	Junction Temperature	+150°C
$\overline{\text{SHDN}}$, MODE to GND	-0.3V to (V _{CC} + 0.3V)	Thermal Resistance from Junction to Backside.....	1°C/W
BIAS_ to GND.....	-0.3V to (V _{CC} + 0.3V)	Thermal Resistance from Junction to Ambient	(using MAX2251 EV kit).....
RF Input Power	+10dBm		40°C/W
Continuous Power Dissipation (T _A = +70°C)		Storage Temperature Range	-65°C to +150°C
4 × 4 UCSP (derate 80mW/°C above +70°C)	4W	Bump Reflow Temperature	+235°C
Operating Temperature Range	-40°C to +85°C	Continuous Operating Lifetime	10 yrs × 0.92 ^(T_A - 45°C)
		(At P _{OUT} = +32dBm, for Operating Temperature, T _A ≥ 45°C)	

Stresses beyond those listed under "Absolute Maximum Ratings" may cause permanent damage to the device. These are stress ratings only, and functional operation of the device at these or any other conditions beyond those indicated in the operational sections of the specifications is not implied. Exposure to absolute maximum rating conditions for extended periods may affect device reliability.

DC ELECTRICAL CHARACTERISTICS

(V_{CC} = +2.8V to +4.5V, no RF signal applied, $\overline{\text{SHDN}}$ = high, T_A = -40°C to +85°C, unless otherwise noted. Typical values are measured at V_{CC} = +3.3V and T_A = +25°C.)

PARAMETER	CONDITIONS		MIN	TYP	MAX	UNITS
Idle Supply Current	MODE = high			205	255	mA
Logic High Threshold			2.0			V
Logic Low Threshold					0.8	V
Shutdown Supply Current	$\overline{\text{SHDN}}$ = MODE = GND	V _{CC} = +2.8V to +4.0V		0.6	10	μA
		V _{CC} = +4.5V		60	120	
Logic High Input Current					5	μA
Logic Low Input Current			-1		+1	μA

+2.8V, Single-Supply, Cellular-Band Linear Power Amplifier

MAX2251

AC CHARACTERISTICS, TDMA OPERATION

(MAX2251 EV kit, $f_{IN} = 824\text{MHz}$ to 849MHz , $V_{CC} = V_{MODE} = V_{SHDN} = +3.3\text{V}$, 50Ω system, NADC modulation, duty cycle = 100%, $T_A = +25^\circ\text{C}$, unless otherwise noted. Typical values are at $f_{IN} = 836\text{MHz}$, $T_A = +25^\circ\text{C}$.) (Note 1)

PARAMETER	CONDITIONS	MIN	-4.5 σ	TYP	4.5 σ	MAX	UNITS
Frequency Range (Note 2)	$V_{MODE} = V_{CC}$ or GND	824				849	MHz
Power Gain	$P_{OUT} = +30\text{dBm}$	25.7	26.1	27.8			dB
Extreme Condition Power Gain	$T_A = -40^\circ\text{C}$ to $+85^\circ\text{C}$, $P_{OUT} = +30\text{dBm}$	24.8	25.2				dB
Output Power	$V_{CC} = +3.3\text{V}$, meets ACPR specifications	30					dBm
Adjacent/Alternate-Channel Power Ratio	$f_{OFFSET} = 30/60\text{kHz}$ in 25kHz bandwidth	$T_A = +25^\circ\text{C}$		-29.3/ -47.5	-27.4/ -45.4	-27/ -44.6	dBc
		$T_A = +85^\circ\text{C}$		-28/ -48			
AMPS Output Power	$V_{MODE} = V_{CC}$, $P_{IN} = +8\text{dBm}$ single tone	31.8	32				dBm
Power-Added Efficiency	$P_{OUT} = +30\text{dBm}$			41.2			%
AMPS Power-Added Efficiency	$P_{IN} = +8\text{dBm}$ single tone at 836MHz			51			%
Turn-On Time (Note 3)				2		5	μs
Input VSWR				1.2:1		1.76:1	
Maximum Nonharmonic Spurious Due to Load Mismatch	$V_{CC} = +2.8\text{V}$ to $+4.5\text{V}$, all input power levels, VSWR = 4:1 all phase angle, $T_A = -40^\circ\text{C}$ to $+85^\circ\text{C}$					-55	dBc
Noise Power	$f_{RF} = 849\text{MHz}$, noise measured at 869MHz, $P_{OUT} = +30\text{dBm}$			-121			dBm/ Hz
AMPS Noise Power	$f_{RF} = 836\text{MHz}$, noise measured at 881MHz, $P_{OUT} = +31\text{dBm}$			-141			dBm/ Hz
Harmonic Suppression (Note 4)				45			dBc
Power Detector Range	(Note 5)	27		29.4			dB
Power Detector Settling Time (Note 6)	$C_{DET} = 4700\text{pF}$			2		3	μs

Note 1: Guaranteed by design and characterization.

Note 2: Operation outside the frequency range is possible, but has not been characterized.

Note 3: Time when V_{SHDN} transitions to V_{CC} until P_{OUT} is within 1dB of its final mean power.

Note 4: Harmonics are measured on the MAX2251 EV kit. The output matching provides some harmonic attenuation in addition to the rejection provided by the IC. The combined suppression is specified.

Note 5: The range is defined by the difference between the rated linear output power and the output power that corresponds to $V_{PD} = 0.57\text{V}$.

Note 6: Time from when V_{SHDN} transitions high until detector output reaches within 10% of its final value.

+2.8V, Single-Supply, Cellular-Band Linear Power Amplifier

Typical Operating Characteristics

(MAX2251 EV kit, $V_{CC} = V_{MODE} = V_{SHDN} = +3.3V$, $f_{IN} = 836MHz$, TDMA modulation, $T_A = +25^\circ C$, unless otherwise noted.)

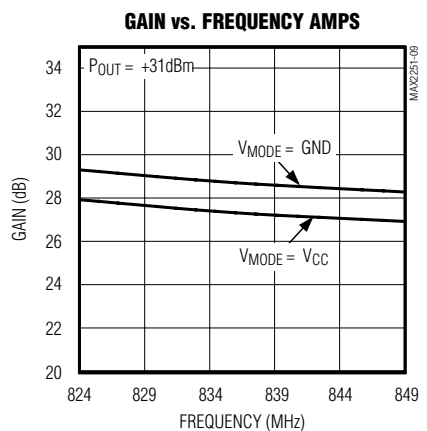
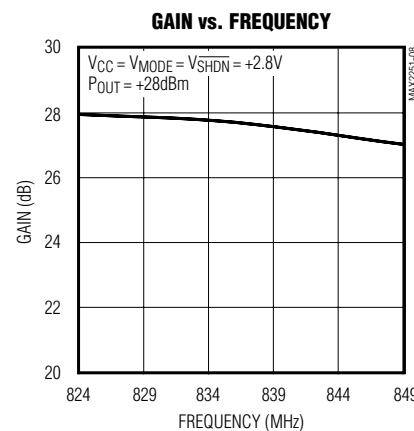
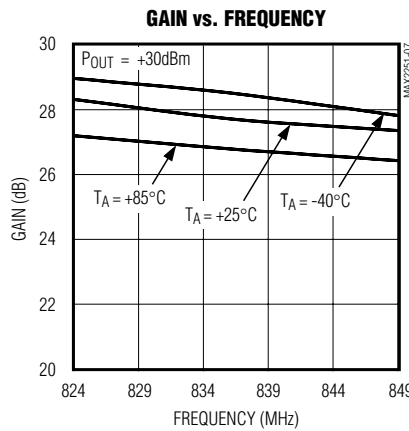
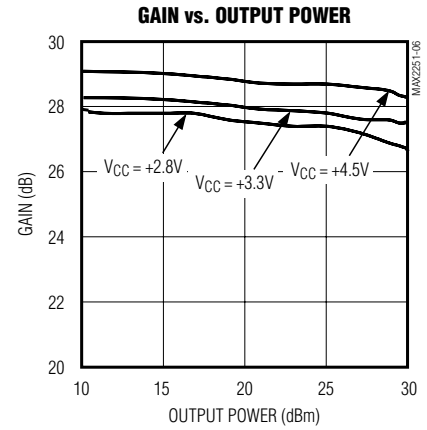
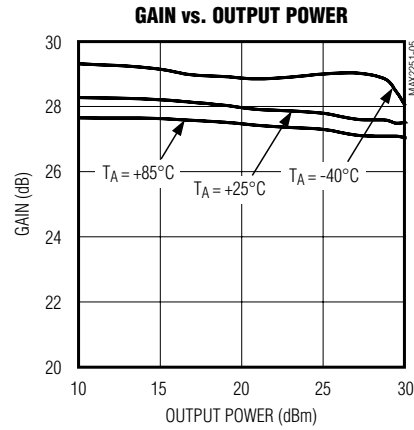
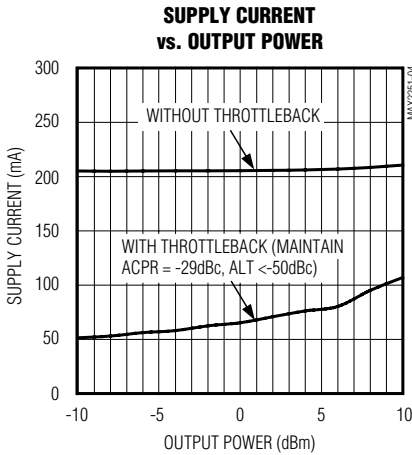
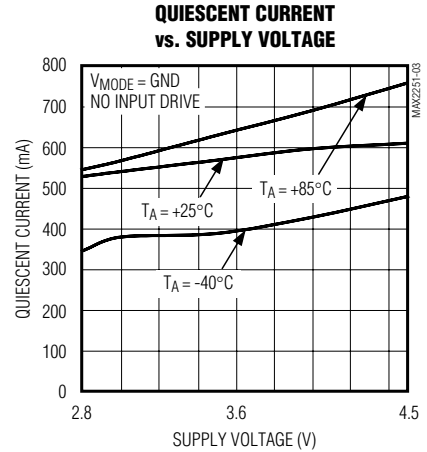
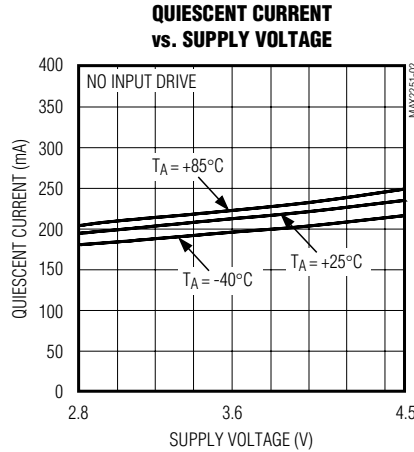
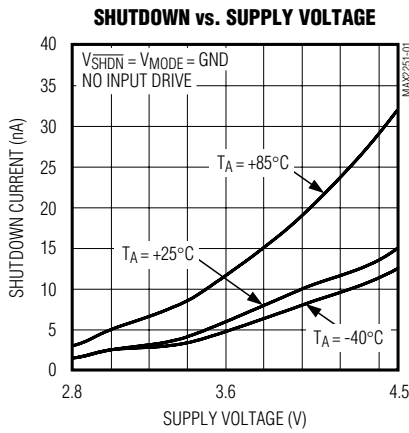

+2.8V, Single-Supply, Cellular-Band Linear Power Amplifier

Typical Operating Characteristics (continued)

(MAX2251 EV kit, $V_{CC} = V_{MODE} = V_{SHDN} = +3.3V$, $f_{IN} = 836MHz$, TDMA modulation, $T_A = +25^\circ C$, unless otherwise noted.)

MAX2251

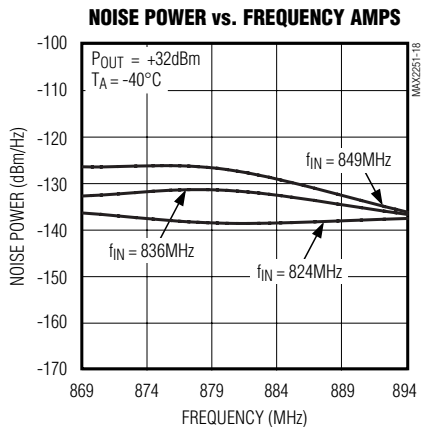
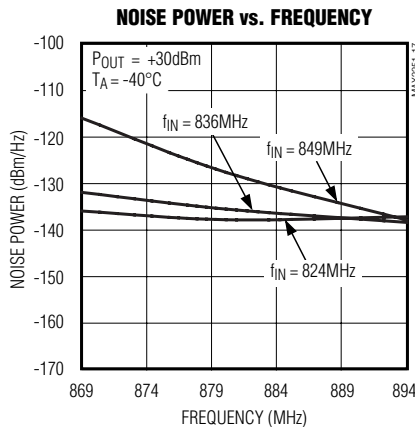
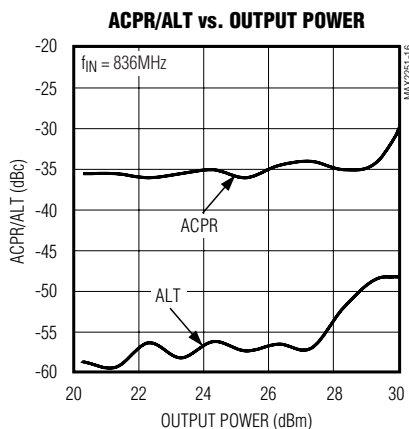
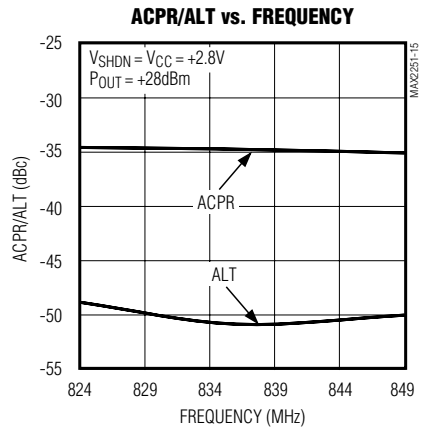
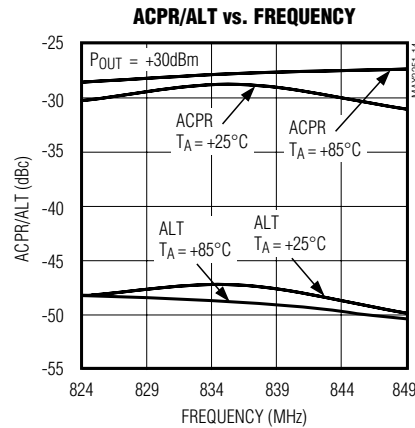
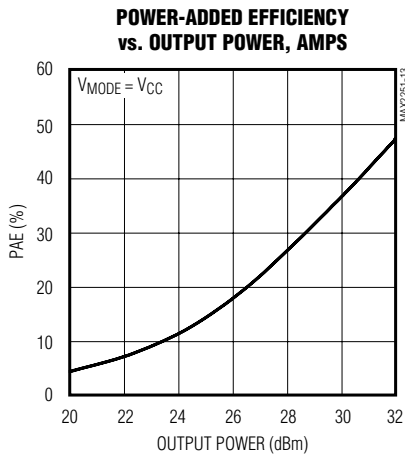
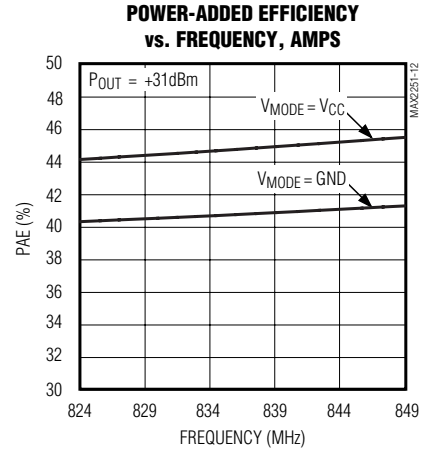
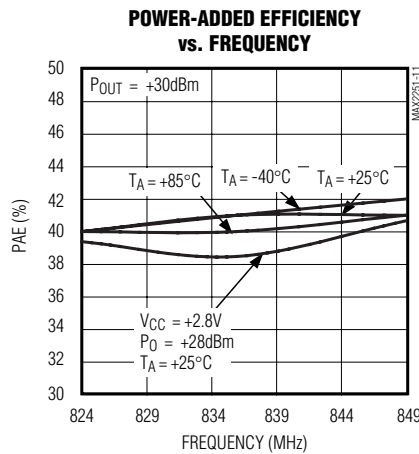
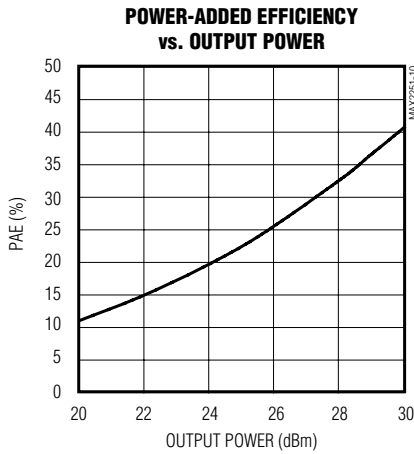

+2.8V, Single-Supply, Cellular-Band Linear Power Amplifier

Typical Operating Characteristics (continued)

(MAX2251 EV kit, $V_{CC} = V_{MODE} = V_{SHDN} = +3.3V$, $f_{IN} = 836MHz$, TDMA modulation, $T_A = +25^\circ C$, unless otherwise noted.)

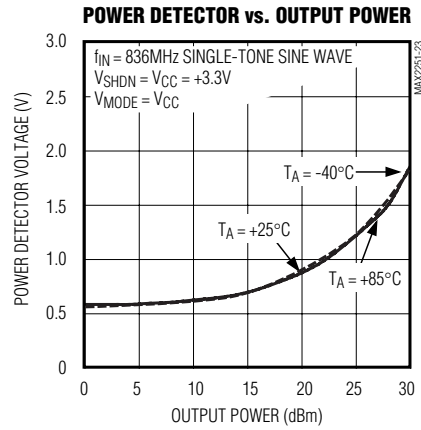
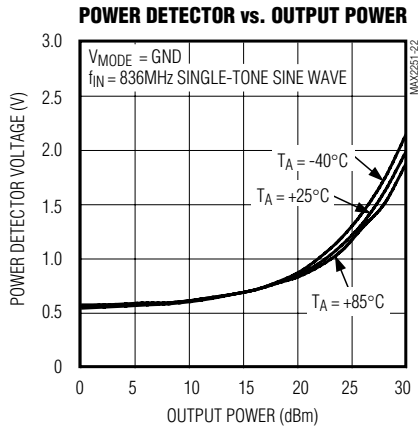
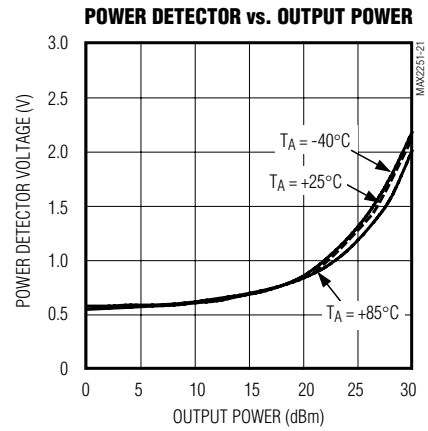
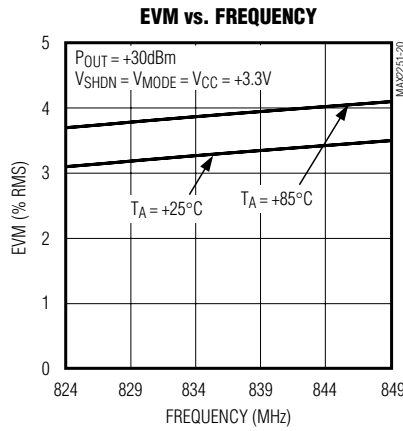
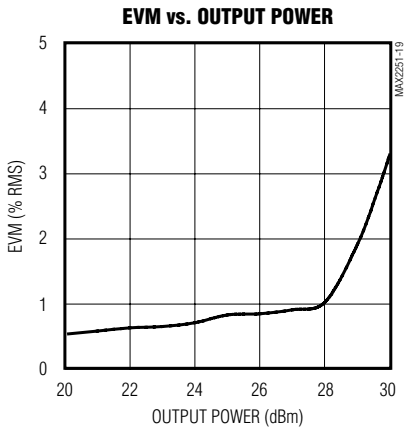

+2.8V, Single-Supply, Cellular-Band Linear Power Amplifier

MAX2251

Pin Description

PIN	NAME	FUNCTION
A1	BIAS2	Second Stage Bias Control. Connect an 11k Ω resistor to GND to set the bias current for the second stage of the PA.
A2, A3, A4, B2, C2, C4	GND	Ground. Connect to the PC board ground plane with as low an inductance path as possible.
B1	PD_OUT	Power Detector Output. This output is a DC voltage indicating the PA output power. Connect a capacitor to set time constant. The settling time is typically 2 μ s with a 4700pF capacitor.
B3, B4	OUT	RF Output. Connect a pullup high-Q inductor to V _{CC} . Requires matching network. Connect B3 and B4 together.
C1	BIAS1	First Stage Bias Control. Connect an external 47.5k Ω resistor to ground to set the bias current for the driver stage.
C3	V _{CC}	Driver Stage Supply Voltage. Connect a pullup inductor to V _{CC} . The pullup inductor can be a PC board trace.
D1	V _{CC}	Supply Voltage. Bypass to ground with 100pF and 0.01 μ F capacitors.
D2	IN	RF Input. Requires a highpass L-section impedance matching network.
D3	$\overline{\text{SHDN}}$	Shutdown Input. Drive logic low to place the device in shutdown mode. Drive logic high for normal operation.
D4	MODE	Mode Selection Input. Drive logic high for TDMA/AMPS mode. Drive logic low for higher gain AMPS operation.

Detailed Description

The MAX2251 is a linear PA intended for TDMA/AMPS dual-mode applications. The PA is fully characterized in the 824MHz to 849MHz U.S. cellular band. The PA consists of a driver stage and an output stage; both are independently biased using external resistors. The MAX2251 also features an integrated power detector.

Bias Control

External resistors connected to C1 and A1 independently set the bias currents of the driver and output stages, respectively. An internal bandgap reference fixes the voltages at C1 and A1. R_{BIAS1} is typically 47.5k Ω and R_{BIAS2} is typically 11k Ω . The bias current can be dynamically adjusted by summing a current into the bias pin of interest with an external source such as a DAC. See the *Typical Operating Circuit*. The *Typical Operating Characteristics* graph, Supply Current vs. Output Power, demonstrates the current saving with throttleback at low-output power levels.

Power Detector

The on-chip power detector monitors the output power. The power detector outputs a voltage proportional to the output power. Connect a filter capacitor from PD_OUT to GND to set the power detector time con-

stant. The integrated power detector eliminates the need for an external detector circuit.

Applications Information

External Matching

The MAX2251 requires input, interstage, and output matching circuits for proper operation. See the *Typical Operating Circuit* for suggested component values. Use high-quality components for L2 and C12 in the output-matching circuit for highest efficiency. The MAX2251 EV kit uses a trace as a pullup inductor (approximately 2nH) for the interstage matching.

Mode Selection

MAX2251 features two modes of operation: high-linear mode and high-gain mode. For TDMA operation, drive MODE high or connect to V_{CC}. For AMPS operation, drive MODE high for best PAE, or drive MODE low for best gain.

Layout and Thermal Management Issues

The MAX2251 EV kit serves as a layout guide. Use controlled impedance lines on all high-frequency inputs and outputs. Connect GND to the PC board ground plane with as low inductance path as possible. The GND pins also serve as heat sinks. Connect all GND

+2.8V, Single-Supply, Cellular-Band Linear Power Amplifier

pins directly to the topside RF ground. On boards where the ground plane is not on the component side, connect all GND pins to the ground plane with plated through holes, close to the package. PC board traces connecting the GND pins also serve as heat sinks. Make sure that the traces are sufficiently wide.

UCSP Reliability

The ultra-chip-scale package (UCSP) represents a unique packaging form factor that may not perform equally to a packaged product through traditional mechanical reliability tests. CSP reliability is integrally linked to the user's assembly methods, circuit board material, and usage environment. The user should closely review these areas when considering use of a CSP. Performance through Operating Life Test and Moisture Resistance remains uncompromised as it is primarily determined by the wafer-fabrication process.

Mechanical stress performance is a greater consideration for a CSP. CSPs are attached through direct solder contact to the user's PC board, foregoing the inherent stress relief of a packaged-product lead frame. Solder joint contact integrity must be considered. Testing done to characterize the CSP reliability performance shows that it is capable of performing reliably through environmental stresses. Users should also be aware that, as with any interconnect system there are electro-migration-based current limits that, in this case, apply to the maximum allowable current in the bumps. Reliability is a function of this current, the duty cycle, lifetime, and bump temperature. See the *Absolute Maximum Ratings* section of the data sheet for any specific limitations, listed under Continuous Operating Lifetime. Results of environmental stress tests and additional usage data and recommendations are detailed in the UCSP application note, which can be found on Maxim's website at www.maxim-ic.com.

+2.8V, Single-Supply, Cellular-Band Linear Power Amplifier

Typical Operating Circuit

MAX2251

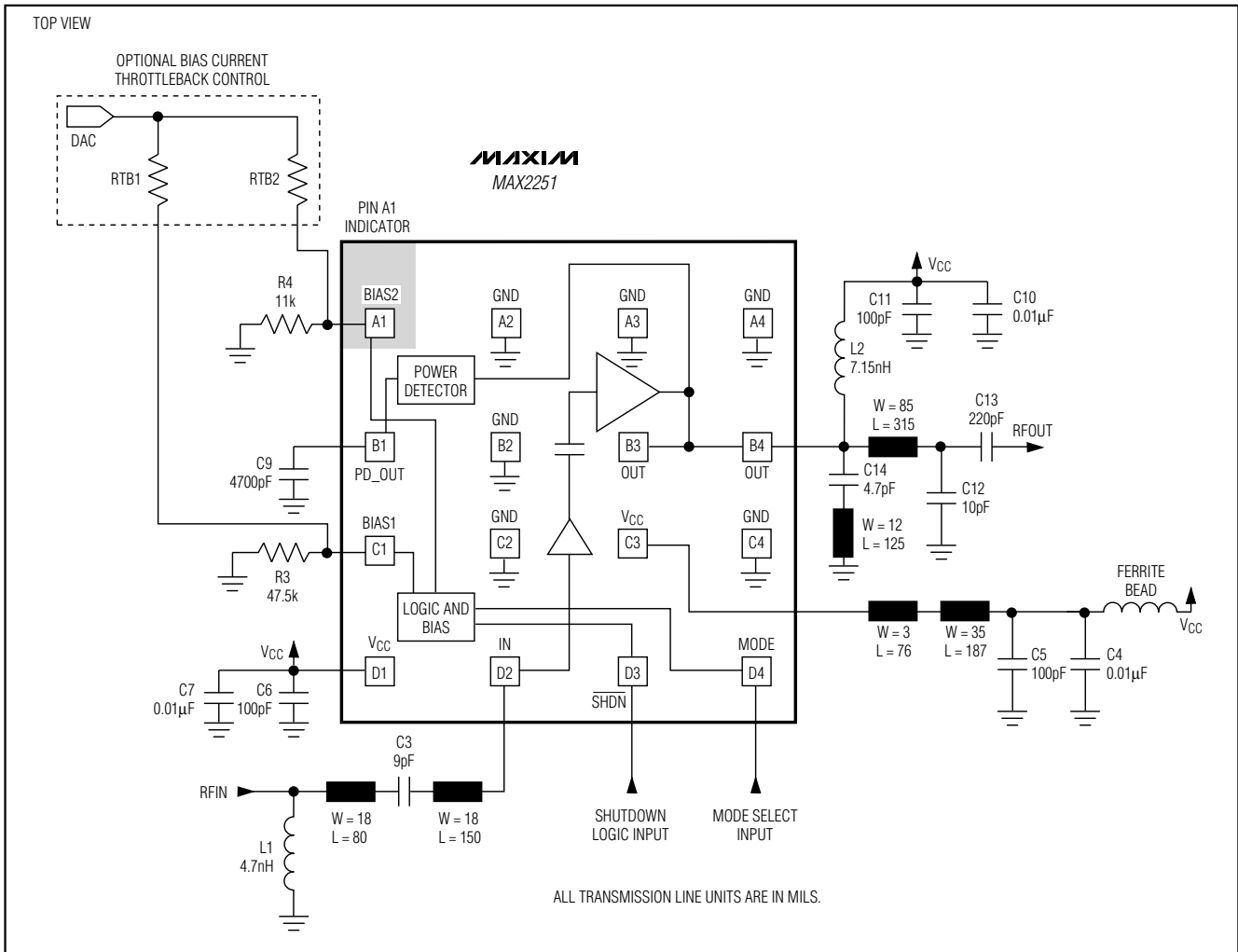

+2.8V, Single-Supply, Cellular-Band Linear Power Amplifier

Package Information

(The package drawing(s) in this data sheet may not reflect the most current specifications. For the latest package outline information, go to www.maxim-ic.com/packages.)

16LUCSP.EPS

TOP VIEW

BOTTOM VIEW

SIDE VIEW

COMMON DIMENSIONS		VARIABLE DIMENSIONS		DEPOPULATED SOLDER BALLS
		D	E	
A	0.60±0.05	B16-1	2.02±0.05	NONE
A1	0.27±0.03	B16-2	2.02±0.05	B3, C3
A2	0.33 REF.	B16-3	2.02±0.05	B3, C2
b	∅0.37 BASIC	B16-4	2.02±0.05	B2, C3
D1	1.50 BASIC			
E1	1.50 BASIC			
e	0.50 BASIC			
SD	0.25 BASIC			
SE	0.25 BASIC			

NOTES:
1. ALL DIMENSIONS ARE IN MILLIMETERS.
2. PRODUCT MARKING: NUMBER OF CHARACTERS AND LINES VARY PER PRODUCT.

MAXIM

PROPRIETARY INFORMATION

TITLE:
PACKAGE OUTLINE, 4x4 UCSP

APPROVAL	DOCUMENT CONTROL NO. 21-0101	REV. F	1/1
----------	---------------------------------	-----------	-----

Maxim cannot assume responsibility for use of any circuitry other than circuitry entirely embodied in a Maxim product. No circuit patent licenses are implied. Maxim reserves the right to change the circuitry and specifications without notice at any time.

10 _____ **Maxim Integrated Products, 120 San Gabriel Drive, Sunnyvale, CA 94086 408-737-7600**