

# DS64EV100 Programmable Single Equalizer

## General Description

The DS64EV100 programmable equalizer provides compensation for transmission medium losses and reduces the medium-induced deterministic jitter for NRZ data channel. The DS64EV100 is optimized for operation up to 10 Gbps for both cables and FR4 traces. The equalizer channel has eight levels of input equalization that can be programmed by three control pins.

The equalizer supports both AC and DC-coupled data paths for long run length data patterns such as PRBS-31, and balanced codes such as 8b/10b. The device uses differential current-mode logic (CML) inputs and outputs, and is available in a 3 mm x 4 mm 14-pin leadless LLP package. Power is supplied from either a 2.5V or 3.3V supply.

## Features

- Equalizes up to 24 dB loss at 10 Gbps
- Equalizes up to 22 dB loss at 6.4 Gbps
- 8 levels of programmable equalization
- Operates up to 10 Gbps with 30" FR4 traces
- Operates up to 6.4 Gbps with 40" FR4 traces
- 0.175 UI residual deterministic jitter at 6.4 Gbps with 40" FR4 traces
- Single 2.5V or 3.3V power supply
- Supports AC or DC-Coupling with wide input common-mode
- Low power consumption: 100 mW Typ at 2.5V
- Small 3 mm x 4 mm 14-pin LLP package
- >8 kV HBM ESD
- -40 to 85°C operating temperature range

## Simplified Application Diagram

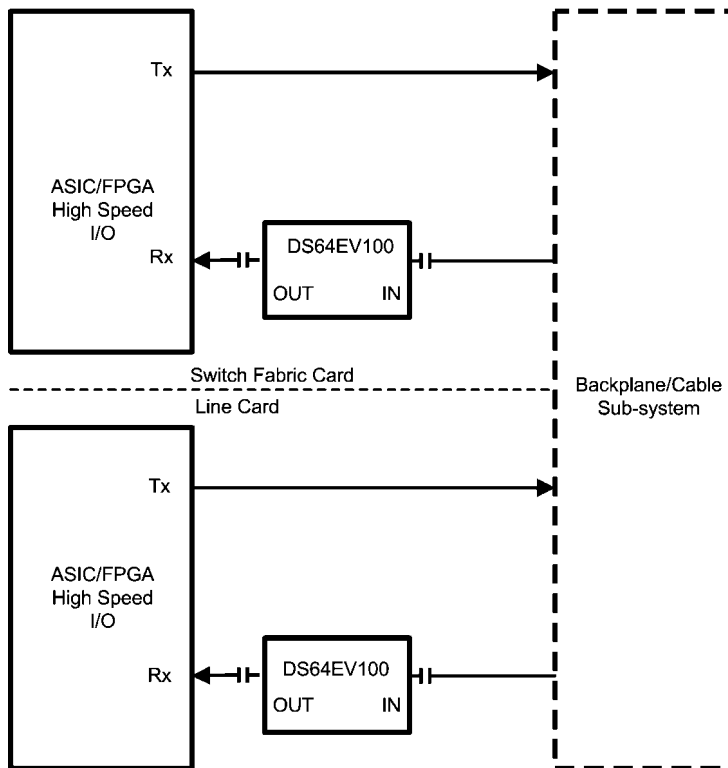

20196401

## Pin Diagram

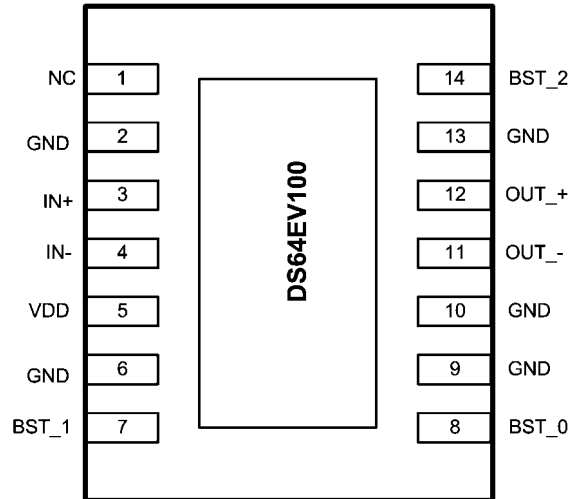

20196402

**Top View**  
**3mm x 4mm 14-Pin LLP Package**  
**Order number DS64EV100**  
**See NS Package Number SDA14A**

## Pin Descriptions

Pin Name	Pin Number	I/O, Type	Description
<b>HIGH SPEED DIFFERENTIAL I/O</b>			
IN+	3	I, CML	Inverting and non-inverting CML differential inputs to the equalizer. An on-chip 100Ω terminating resistor is connected between IN+ and IN-.
IN-	4		
OUT+	12	O, CML	Inverting and non-inverting CML differential outputs from the equalizer. An on-chip 50Ω terminating resistor connects OUT+ to V <sub>DD</sub> and OUT- to V <sub>DD</sub> .
OUT-	11		
<b>EQUALIZATION CONTROL</b>			
BST_2	14	I, CMOS	BST_2, BST_1, and BST_0 select the equalizer strength for EQ channel 1. BST_2 is internally pulled high. BST_1 and BST_0 are internally pulled low.
BST_1	7		
BST_0	8		
<b>POWER</b>			
V <sub>DD</sub>	5	I, Power	V <sub>DD</sub> = 2.5V ±5% or 3.3V ±10%. V <sub>DD</sub> pins should be tied to V <sub>DD</sub> plane through low inductance path. A 0.01μF bypass capacitor should be connected between each V <sub>DD</sub> pin to GND planes.
GND	2, 6, 9, 10, 13	I, Power	Ground reference. GND should be tied to a solid ground plane through a low impedance path.
Exposed Pad	PAD	I, Power	Ground reference. The exposed pad at the center of the package must be connected to ground plane of the board.
<b>OTHER</b>			
NC	1		Reserved. Do not connect.

**Note:** I = Input, O = Output

**Absolute Maximum Ratings** (Note 1)

If Military/Aerospace specified devices are required, please contact the National Semiconductor Sales Office/Distributors for availability and specifications.

If Military/Aerospace specified devices are required, please contact the National Semiconductor sales offices/distributors for availability and specifications.

Supply Voltage ( $V_{DD}$ )	-0.5V to +4V
CMOS Input Voltage	-0.5V to +4.0V
CMOS Output Voltage	-0.5V to +4.0V
CML Input/Output Voltage	-0.5V to +4.0V
Junction Temperature	+150°C
Storage Temperature	-65°C to +150°C
Lead Temperature	
Soldering, 4 sec	+260°C

## ESD Rating

HBM, 1.5 k $\Omega$ , 100 pF	>8 kV
EIAJ, 0 $\Omega$ , 200 pF	>250V
Thermal Resistance, $\theta_{JA}$ , No Airflow	40 °C/W

**Recommended Operating Conditions**

	Min	Typ	Max	Units
Supply Voltage				
$V_{DD2.5}$ to GND	2.375	2.5	2.625	V
$V_{DD3.3}$ to GND	3.0	3.3	3.6	V
Ambient Temperature	-40	25	+85	°C

**Electrical Characteristics**

Over recommended operating supply and temperature ranges unless other specified. (Notes 2, 3))

Symbol	Parameter	Conditions	Min	Typ (Note 3)	Max	Units
<b>POWER</b>						
P	Power Supply Consumption	$V_{DD3.3}$		140	200	mW
		$V_{DD2.5}$		100	150	mW
N	Supply Noise Tolerance (Note 4)	50 Hz – 100 Hz		100		mV <sub>P-P</sub>
		100 Hz – 10 MHz		40		mV <sub>P-P</sub>
		10 MHz – 1.6 GHz		10		mV <sub>P-P</sub>
<b>LVTTL DC SPECIFICATIONS</b>						
$V_{IH}$	High Level Input Voltage	$V_{DD3.3}$	2.0		$V_{DD}$	V
		$V_{DD2.5}$	1.6		$V_{DD}$	V
$V_{IL}$	Low Level Input Voltage		-0.3		0.8	V
$V_{OH}$	High Level Output Voltage	$I_{OH} = -3mA, V_{DD3.3}$			-1.5	V
		$I_{OH} = -3mA, V_{DD2.5}$	2.0			V
$V_{OL}$	Low Level Output Voltage	$I_{OL} = 3mA$			0.4	V
$I_{IN}$	Input Current	$V_{IN} = V_{DD}$		+1.8	+15	$\mu A$
		$V_{IN} = GND$	-15	0		$\mu A$
$I_{IN-P}$	Input Leakage Current with Internal Pull-Down/Up Resistors	$V_{IN} = GND$ , with internal pull-down resistors		+95		$\mu A$
		$V_{IN} = GND$ , with internal pull-up resistors	-20			$\mu A$
<b>CML RECEIVER INPUTS (IN+, IN-)</b>						
$V_{INTRE}$	Input Threshold Voltage	Differential measurement at point B (Figure 1)		120		mV <sub>P-P</sub>
$V_{IN}$	Input Voltage Swing	AC-Coupled or DC-Coupled Requirement Differential measurement at point A (Figure 1)	400		1600	mV <sub>P-P</sub>
$V_{DDTX}$	Supply Voltage of Transmitter to EQ	DC-Coupled Requirement (Note 9)	1.6		$V_{DD}$	V
$V_{ICMDC}$	Input Common-Mode Voltage	DC-Coupled Requirement Differential measurement at point A (Figure 1) (Note 7)	$V_{DDTX}-0.8$		$V_{DDTX}-0.2$	V

Symbol	Parameter	Conditions	Min	Typ	Max	Units
$R_{LI}$	Differential Input Return Loss	100 MHz – 1.6 GHz, with fixture's effect de-embedded		10		dB
$R_{IN}$	Differential Input Return Loss	Differential Across IN+ and IN-	85	100	115	$\Omega$
<b>CML OUTPUTS (OUT+, OUT-)</b>						
$V_O$	Output Voltage Swing	Differential measurement with OUT+ and OUT- terminated by 50 $\Omega$ to GND AC-Coupled (Figure 2)	500		725	mV <sub>P-P</sub>
$V_{OCM}$	Output Common-Mode Voltage	Single-ended measurement DC-Coupled with 50 $\Omega$ terminations (Note 7)	$V_{DD}-0.2$		$V_{DD}-0.1$	V
$t_R, t_F$	Transition Time	20% to 80% of differential output voltage, measured within 1" from output pins. (Figure 2) (Note 7)	20		45	ps
$R_O$	Output Resistance	Single-ended to $V_{DD}$	42	50	58	$\Omega$
$R_{LO}$	Differential Output Return Loss	100 MHz–3.2 GHz, with fixture's effect de-embedded. IN+ = static high.		10		dB
$t_{PLHD}$	Differential Low to High Propagation Delay	Propagation delay measurement at 50% VO between input to output, 100 Mbps (Figure 3) (Note 7)		240		ps
$t_{PHLD}$	Differential High to Low Propagation Delay			240		ps
<b>EQUALIZATION</b>						
DJ1	Residual Deterministic Jitter at 10 Gbps	30" of 6 mil microstrip FR4, EQ Setting 0x06, PRBS-7 (2 <sup>7</sup> – 1) pattern (Note 6)		0.20		UI <sub>P-P</sub>
DJ2	Residual Deterministic Jitter at 6.4 Gbps	40" of 6 mil microstrip FR4, EQ Setting 0x06, PRBS-7 (2 <sup>7</sup> – 1) pattern (Note 5,6)		0.17	0.26	UI <sub>P-P</sub>
DJ3	Residual Deterministic Jitter at 5 Gbps	40" of 6 mil microstrip FR4, EQ Setting 0x07, PRBS-7 (2 <sup>7</sup> – 1) pattern (Note 5,6)		0.12	0.20	UI <sub>P-P</sub>
DJ4	Residual Deterministic Jitter at 2.5 Gbps	40" of 6 mil microstrip FR4, EQ Setting 0x07, PRBS-7 (2 <sup>7</sup> – 1) pattern (Note 5,6)		0.10	0.16	UI <sub>P-P</sub>
RJ	Random Jitter	(Note 7,8)		0.5		ps <sub>rms</sub>
<p><b>Note 1:</b> "Absolute Maximum Ratings" indicate limits beyond which damage to the device may occur, including inoperability and degradation of device reliability and/or performance. Functional operation of the device and/or non-degradation at the Absolute Maximum Ratings or other conditions beyond those indicated in the Recommended Operating Conditions is not implied. The Recommended Operating Conditions indicate conditions at which the device is functional and the device should not be operated beyond such conditions. Absolute Maximum Numbers are guaranteed for a junction temperature range of –40°C to +125°C. Models are validated to Maximum Operating Voltages only.</p> <p><b>Note 2:</b> Typical values represent most likely parametric norms at <math>V_{DD} = 3.3V</math> or <math>2.5V</math>, <math>T_A = 25^\circ C</math>., and at the Recommended Operation Conditions at the time of product characterization and are not guaranteed.</p> <p><b>Note 3:</b> The Electrical Characteristics tables list guaranteed specifications under the listed Recommended Operating Conditions except as otherwise modified or specified by the Electrical Characteristics Conditions and/or Notes. Typical specifications are estimations only and are not guaranteed.</p> <p><b>Note 4:</b> Allowed supply noise (mV<sub>P-P</sub> sine wave) under typical conditions.</p> <p><b>Note 5:</b> Specification is guaranteed by characterization at optimal boost setting and is not tested in production.</p> <p><b>Note 6:</b> Deterministic jitter is measured at the differential outputs (point C of Figure 1), minus the deterministic jitter before the test channel (point A of Figure 1). Random jitter is removed through the use of averaging or similar means.</p> <p><b>Note 7:</b> Measured with clock-like {11111 00000} pattern.</p> <p><b>Note 8:</b> Random jitter contributed by the equalizer is defined as <math>\sqrt{J_{OUT}^2 - J_{IN}^2}</math>. <math>J_{OUT}</math> is the random jitter at equalizer outputs in ps<sub>rms</sub>, see point C of Figure 1; <math>J_{IN}</math> is the random jitter at the input of the equalizer in ps<sub>rms</sub>, see point B of Figure 1.</p>						

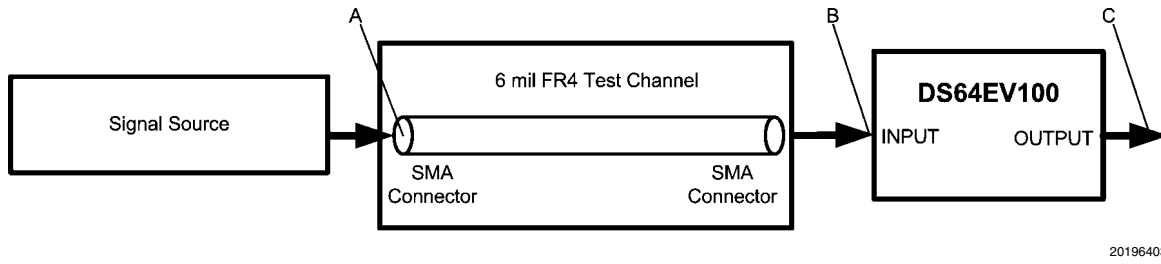

FIGURE 1. Test Setup Diagram

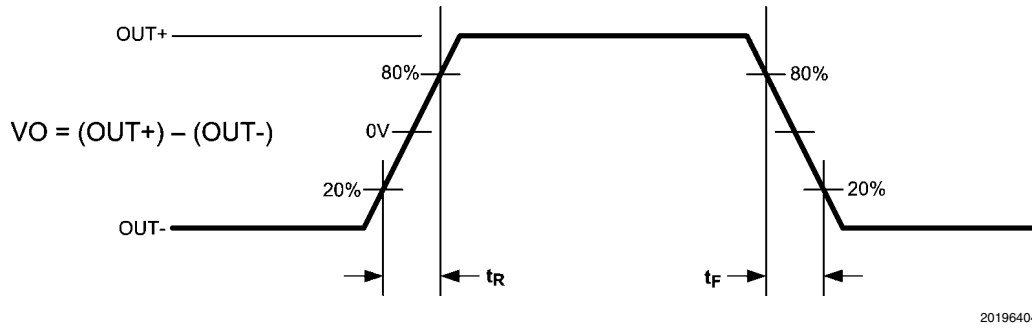

FIGURE 2. CML Output Transition Times

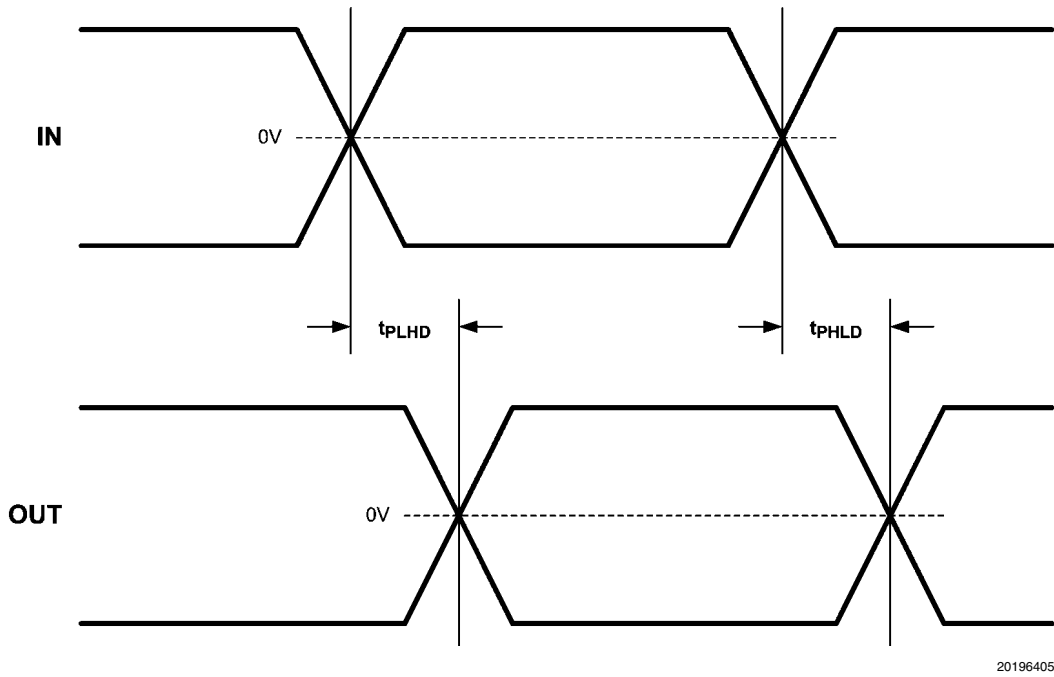
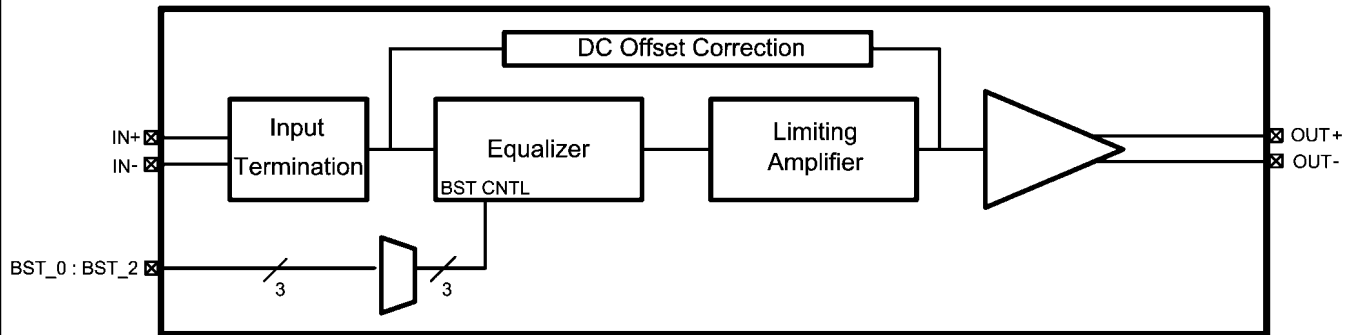

FIGURE 3. Propagation Delay Timing Diagram

## DS64EV100 Applications Information

The DS64EV100 is a programmable equalizer optimized for operation up to 10 Gbps for backplane and cable applications.

The equalizer channel consists of an equalizer stage, a limiting amplifier, a DC offset correction block, and a CML driver as shown in Figure 4.



20196406

FIGURE 4. Simplified Block Diagram

### EQUALIZER BOOST CONTROL

The equalizer channel supports eight programmable levels of equalization boost, and is controlled by the Boost Set pins (BST\_[2:0]) in accordance with Table 1. The eight levels of boost settings enables the DS64EV100 to address a wide range of media loss and data rates.

TABLE 1. EQ Boost Control Table

6 mil Microstrip FR4 Trace Length (in)	24 AWG Twin-AX Cable Length (m)	Channel Loss at 3.2 GHz (db)	Channel Loss at 5 GHz (dB)	[BST_2, BST_1, BST_0]
0	0	0	0	0 0 0
5	2	5	6	0 0 1
10	3	7.5	10	0 1 0
15	4	10	14	0 1 1
20	5	12.5	18	1 0 0
25	6	15	21	1 0 1
30	7	17	24	1 1 0
40	10	22	30	1 1 1

### GENERAL RECOMMENDATIONS

The DS64EV100 is a high performance circuit capable of delivering excellent performance. Careful attention must be paid to the details associated with high-speed design as well as providing a clean power supply. Refer to the LVDS Owner's Manual for more detailed information on high-speed design tips to address signal integrity design issues.

### PCB LAYOUT CONSIDERATIONS FOR DIFFERENTIAL PAIRS

The CML inputs and outputs must have a controlled differential impedance of 100Ω. It is preferable to route CML lines exclusively on one layer of the board, particularly for the input traces. The use of vias should be avoided if possible. If vias must be used, they should be used sparingly and must be placed symmetrically for each side of a given differential pair. Route the CML signals away from other signals and noise sources on the printed circuit board. See AN-1187 for additional information on LLP packages.

### POWER SUPPLY BYPASSING

Two approaches are recommended to ensure that the DS64EV100 is provided with an adequate power supply. First, the supply ( $V_{DD}$ ) and ground (GND) pins should be connected to power planes routed on adjacent layers of the printed circuit board. The layer thickness of the dielectric should be minimized so that the  $V_{DD}$  and GND planes create a low inductance supply with distributed capacitance. Second, careful attention to supply bypassing through the proper use of bypass capacitors is required. A 0.01μF bypass capacitor should be connected to each  $V_{DD}$  pin such that the capacitor is placed as close as possible to the DS64EV100. Smaller body size capacitors can help facilitate proper component placement. Additionally, three capacitors with capacitance in the range of 2.2 μF to 10 μF should be incorporated in the power supply bypassing design as well. These capacitors can be either tantalum or an ultra-low ESR ceramic and should be placed as close as possible to the DS64EV100.

# Typical Performance Eye Diagrams and Curves

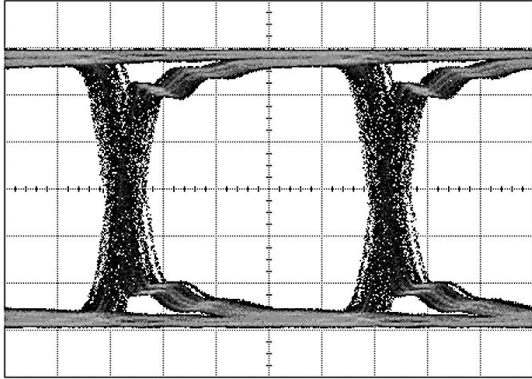

**Figure 5. Equalized Signal**  
(40 in FR4, 2.5 Gbps, PRBS7, 0x07 Setting)

20196407

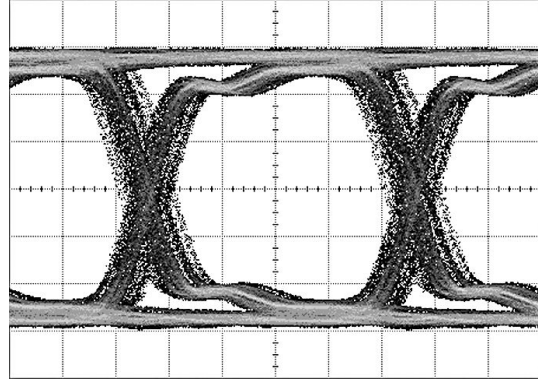

**Figure 6. Equalized Signal**  
(40 in FR4, 5 Gbps, PRBS7, 0x07 Setting)

20196408

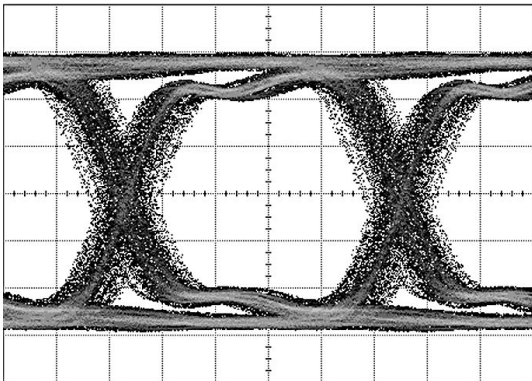

**Figure 7. Equalized Signal**  
(40 in FR4, 6.4 Gbps, PRBS7, 0x06 Setting)

20196409

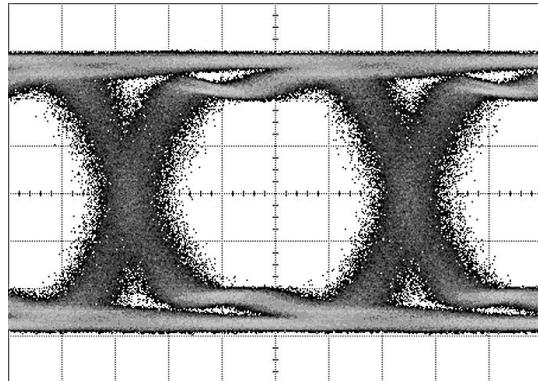

**Figure 8. Equalized Signal**  
(40 in FR4, 6.4 Gbps, PRBS31, 0x06 Setting)

20196410

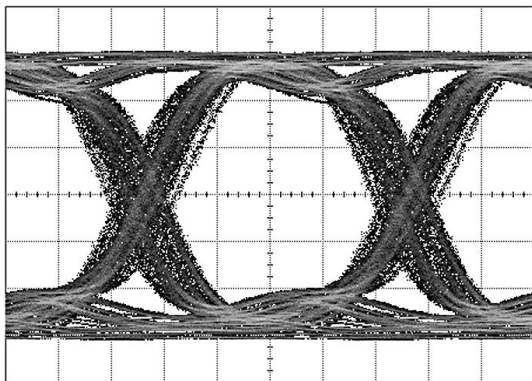

**Figure 9. Equalized Signal**  
(30 in FR4, 10 Gbps, PRBS7, 0x06 Setting)

20196411

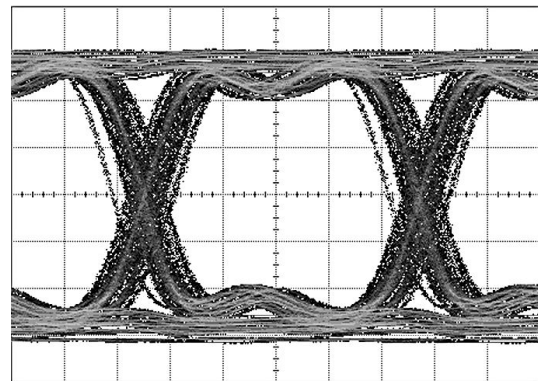

**Figure 10. Equalized Signal**  
(10m 24 AWG Twin-AX Cable, 6.4 Gbps, PRBS7, 0x06 Setting)

20196412



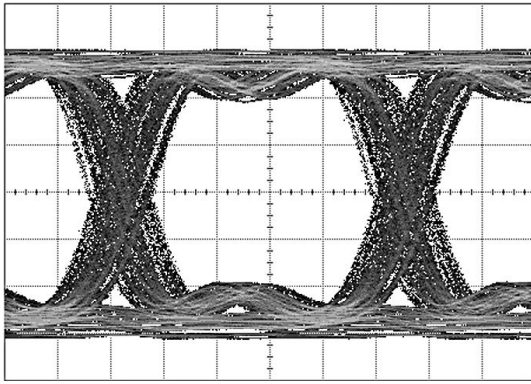

20196413

**Figure 11. Equalized Signal**  
(32 in Tyco XAUI Backplane, 6.25 Gbps, PRBS7, 0x06 Setting)

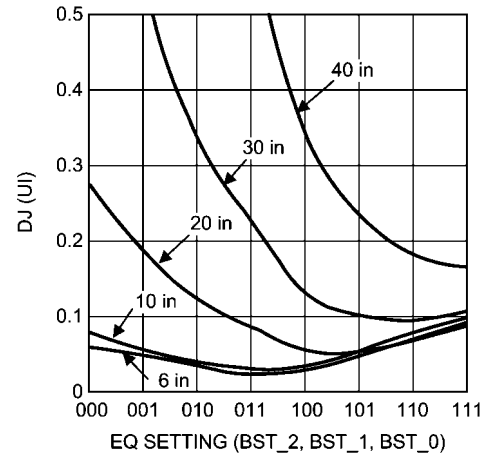

20196414

**Figure 12. DJ vs. EQ Setting (6.4 Gbps)**

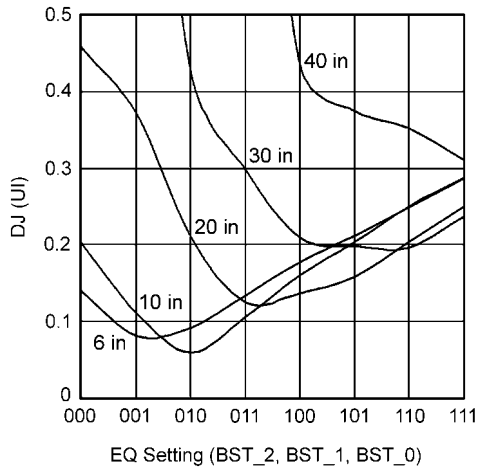

20196415

**Figure 13. DJ vs. EQ Setting (10 Gbps)**



**Physical Dimensions** inches (millimeters) unless otherwise noted

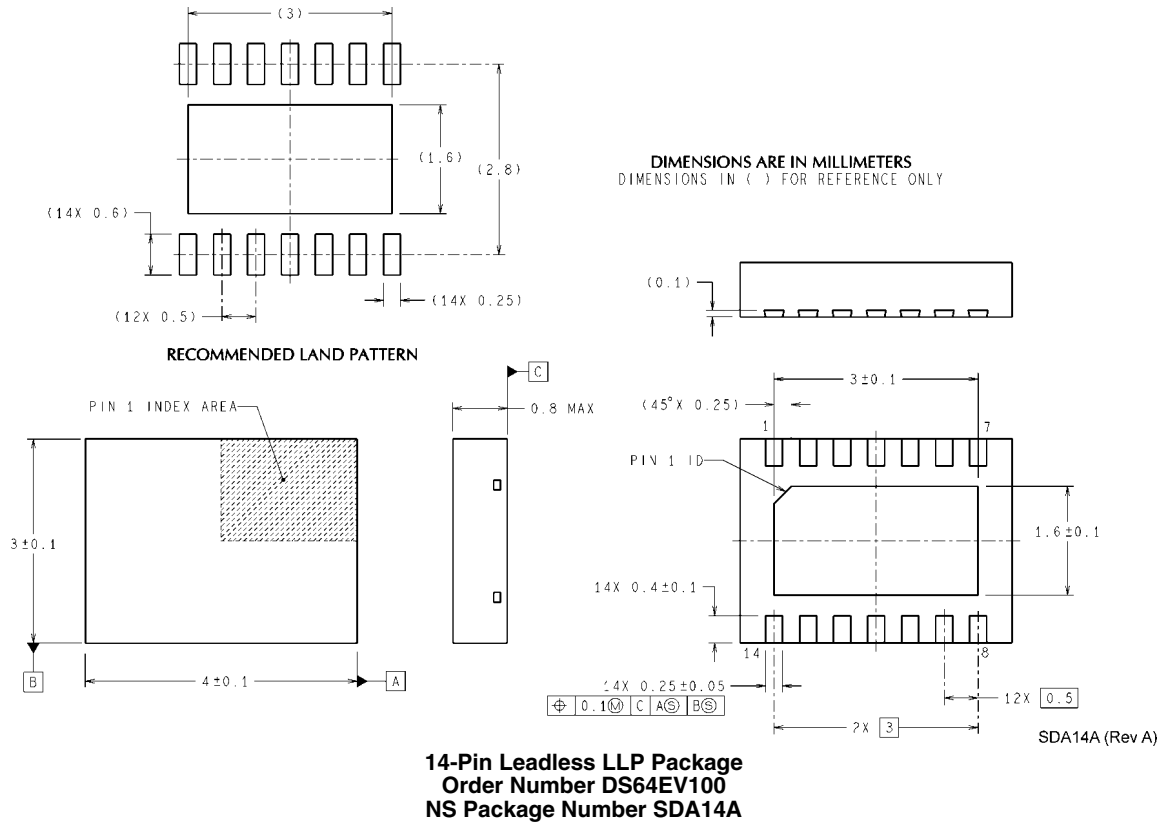

## Notes

For more National Semiconductor product information and proven design tools, visit the following Web sites at:

Products		Design Support	
Amplifiers	<a href="http://www.national.com/amplifiers">www.national.com/amplifiers</a>	WEBENCH	<a href="http://www.national.com/webench">www.national.com/webench</a>
Audio	<a href="http://www.national.com/audio">www.national.com/audio</a>	Analog University	<a href="http://www.national.com/AU">www.national.com/AU</a>
Clock Conditioners	<a href="http://www.national.com/timing">www.national.com/timing</a>	App Notes	<a href="http://www.national.com/appnotes">www.national.com/appnotes</a>
Data Converters	<a href="http://www.national.com/adc">www.national.com/adc</a>	Distributors	<a href="http://www.national.com/contacts">www.national.com/contacts</a>
Displays	<a href="http://www.national.com/displays">www.national.com/displays</a>	Green Compliance	<a href="http://www.national.com/quality/green">www.national.com/quality/green</a>
Ethernet	<a href="http://www.national.com/ethernet">www.national.com/ethernet</a>	Packaging	<a href="http://www.national.com/packaging">www.national.com/packaging</a>
Interface	<a href="http://www.national.com/interface">www.national.com/interface</a>	Quality and Reliability	<a href="http://www.national.com/quality">www.national.com/quality</a>
LVDS	<a href="http://www.national.com/lvds">www.national.com/lvds</a>	Reference Designs	<a href="http://www.national.com/refdesigns">www.national.com/refdesigns</a>
Power Management	<a href="http://www.national.com/power">www.national.com/power</a>	Feedback	<a href="http://www.national.com/feedback">www.national.com/feedback</a>
Switching Regulators	<a href="http://www.national.com/switchers">www.national.com/switchers</a>		
LDOs	<a href="http://www.national.com/ldo">www.national.com/ldo</a>		
LED Lighting	<a href="http://www.national.com/led">www.national.com/led</a>		
PowerWise	<a href="http://www.national.com/powerwise">www.national.com/powerwise</a>		
Serial Digital Interface (SDI)	<a href="http://www.national.com/sdi">www.national.com/sdi</a>		
Temperature Sensors	<a href="http://www.national.com/tempsensors">www.national.com/tempsensors</a>		
Wireless (PLL/VCO)	<a href="http://www.national.com/wireless">www.national.com/wireless</a>		

THE CONTENTS OF THIS DOCUMENT ARE PROVIDED IN CONNECTION WITH NATIONAL SEMICONDUCTOR CORPORATION ("NATIONAL") PRODUCTS. NATIONAL MAKES NO REPRESENTATIONS OR WARRANTIES WITH RESPECT TO THE ACCURACY OR COMPLETENESS OF THE CONTENTS OF THIS PUBLICATION AND RESERVES THE RIGHT TO MAKE CHANGES TO SPECIFICATIONS AND PRODUCT DESCRIPTIONS AT ANY TIME WITHOUT NOTICE. NO LICENSE, WHETHER EXPRESS, IMPLIED, ARISING BY ESTOPPEL OR OTHERWISE, TO ANY INTELLECTUAL PROPERTY RIGHTS IS GRANTED BY THIS DOCUMENT.

TESTING AND OTHER QUALITY CONTROLS ARE USED TO THE EXTENT NATIONAL DEEMS NECESSARY TO SUPPORT NATIONAL'S PRODUCT WARRANTY. EXCEPT WHERE MANDATED BY GOVERNMENT REQUIREMENTS, TESTING OF ALL PARAMETERS OF EACH PRODUCT IS NOT NECESSARILY PERFORMED. NATIONAL ASSUMES NO LIABILITY FOR APPLICATIONS ASSISTANCE OR BUYER PRODUCT DESIGN. BUYERS ARE RESPONSIBLE FOR THEIR PRODUCTS AND APPLICATIONS USING NATIONAL COMPONENTS. PRIOR TO USING OR DISTRIBUTING ANY PRODUCTS THAT INCLUDE NATIONAL COMPONENTS, BUYERS SHOULD PROVIDE ADEQUATE DESIGN, TESTING AND OPERATING SAFEGUARDS.

EXCEPT AS PROVIDED IN NATIONAL'S TERMS AND CONDITIONS OF SALE FOR SUCH PRODUCTS, NATIONAL ASSUMES NO LIABILITY WHATSOEVER, AND NATIONAL DISCLAIMS ANY EXPRESS OR IMPLIED WARRANTY RELATING TO THE SALE AND/OR USE OF NATIONAL PRODUCTS INCLUDING LIABILITY OR WARRANTIES RELATING TO FITNESS FOR A PARTICULAR PURPOSE, MERCHANTABILITY, OR INFRINGEMENT OF ANY PATENT, COPYRIGHT OR OTHER INTELLECTUAL PROPERTY RIGHT.

### LIFE SUPPORT POLICY

**NATIONAL'S PRODUCTS ARE NOT AUTHORIZED FOR USE AS CRITICAL COMPONENTS IN LIFE SUPPORT DEVICES OR SYSTEMS WITHOUT THE EXPRESS PRIOR WRITTEN APPROVAL OF THE CHIEF EXECUTIVE OFFICER AND GENERAL COUNSEL OF NATIONAL SEMICONDUCTOR CORPORATION.** As used herein:

Life support devices or systems are devices which (a) are intended for surgical implant into the body, or (b) support or sustain life and whose failure to perform when properly used in accordance with instructions for use provided in the labeling can be reasonably expected to result in a significant injury to the user. A critical component is any component in a life support device or system whose failure to perform can be reasonably expected to cause the failure of the life support device or system or to affect its safety or effectiveness.

National Semiconductor and the National Semiconductor logo are registered trademarks of National Semiconductor Corporation. All other brand or product names may be trademarks or registered trademarks of their respective holders.

Copyright© 2007 National Semiconductor Corporation

For the most current product information visit us at [www.national.com](http://www.national.com)



**National Semiconductor Americas Customer Support Center**  
 Email: [new.feedback@nsc.com](mailto:new.feedback@nsc.com)  
 Tel: 1-800-272-9959

**National Semiconductor Europe Customer Support Center**  
 Fax: +49 (0) 180-530-85-86  
 Email: [europe.support@nsc.com](mailto:europe.support@nsc.com)  
 Deutsch Tel: +49 (0) 69 9508 6208  
 English Tel: +49 (0) 870 24 0 2171  
 Français Tel: +33 (0) 1 41 91 8790

**National Semiconductor Asia Pacific Customer Support Center**  
 Email: [ap.support@nsc.com](mailto:ap.support@nsc.com)

**National Semiconductor Japan Customer Support Center**  
 Fax: 81-3-5639-7507  
 Email: [jpn.feedback@nsc.com](mailto:jpn.feedback@nsc.com)  
 Tel: 81-3-5639-7560