

# LMH6723/LMH6724/LMH6725

## Single/Dual/Quad 370 MHz 1 mA Current Feedback Operational Amplifier

### General Description

The LMH6723/LMH6724/LMH6725 provides a 260 MHz small signal bandwidth at a gain of +2 V/V and a 600 V/ $\mu$ s slew rate while consuming only 1 mA from  $\pm 5$ V supplies.

The LMH6723/LMH6724/LMH6725 supports video applications with its 0.03% and 0.11° differential gain and phase for NTSC and PAL video signals. The LMH6723/LMH6724/LMH6725 also offers a flat gain response of 0.1 dB to 100 MHz. Additionally, the LMH6723/LMH6724/LMH6725 can deliver 110 mA of linear output current. This level of performance, as well as a wide supply range of 4.5 to 12V, makes the LMH6723/LMH6724/LMH6725 an ideal op amp for a variety of portable applications. The LMH6723/LMH6724/LMH6725's small packages (TSSOP, SOIC & SOT23), low power requirement and high performance allow the LMH6723/LMH6724/LMH6725 to serve a wide variety of portable applications.

The LMH6723/LMH6724/LMH6725 is manufactured in National's VIP10™ complimentary bipolar process.

### Features

- Large signal bandwidth and slew rate 100% tested
- 370 MHz bandwidth ( $A_V = 1$ ,  $V_{OUT} = 0.5 V_{PP}$ ) -3 dB BW
- 260 MHz ( $A_V = +2 V/V$ ,  $V_{OUT} = 0.5 V_{PP}$ ) -3 dB BW
- 1 mA supply current
- 110 mA linear output current
- 0.03%, 0.11° differential gain, phase
- 0.1 dB gain flatness to 100 MHz
- Fast slew rate: 600 V/ $\mu$ s
- Unity gain stable
- Single supply range of 4.5 to 12V
- Improved replacement for CLC450, CLC452, (LMH6723)

### Applications

- Line driver
- Portable video
- A/D driver
- Portable DVD

### Typical Application

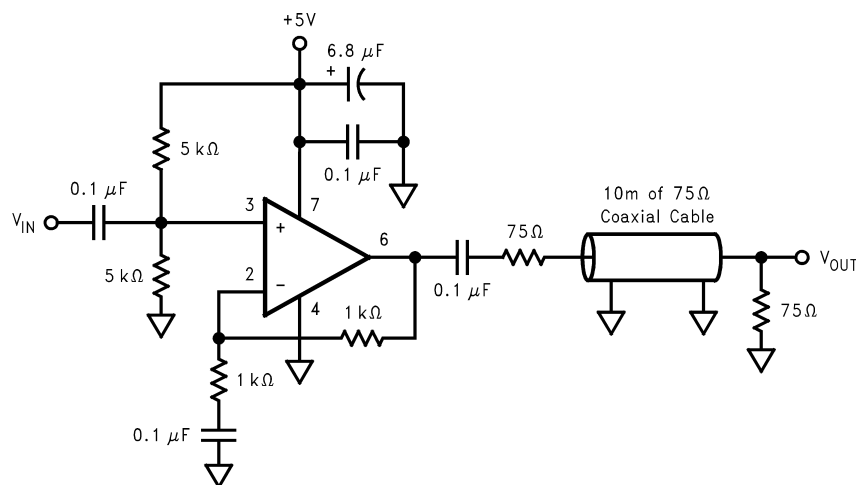

Single Supply Cable Driver

20078936

**Absolute Maximum Ratings** (Note 1)

If Military/Aerospace specified devices are required, please contact the National Semiconductor Sales Office/Distributors for availability and specifications.

$V_{CC}$ ( $V^+ - V^-$ )	$\pm 6.75V$
$I_{OUT}$	120 mA (Note 3)
Common Mode Input Voltage	$\pm V_{CC}$
Maximum Junction Temperature	+150°C
Storage Temperature Range	-65°C to +150°C
Soldering Information	
Infrared or Convection (20 sec)	235°C
Wave Soldering (10 sec)	260°C
ESD Tolerance (Note 4)	

Human Body Model 2000V

Machine Model (Note 4) 200V

**Operating Ratings** (Note 3)

Thermal Resistance	
Package	( $\theta_{JA}$ )
8-Pin SOIC	166°C/W
5-Pin SOT23	230°C/W
14-Pin SOIC	130°C/W
14-Pin TSSOP	160°C/W
Operating Temperature Range	-40°C to +85°C
Nominal Supply Voltage	4.5V to 12V

 **$\pm 5V$  Electrical Characteristics**

Unless otherwise specified,  $A_V = +2$ ,  $R_F = 1200\Omega$ ,  $R_L = 100\Omega$ . **Boldface** limits apply at temperature extremes. (Note 2)

Symbol	Parameter	Conditions	Min	Typ	Max	Units
<b>Frequency Domain Response</b>						
SSBW	-3 dB Bandwidth Small Signal	$V_{OUT} = 0.5 V_{PP}$		260		MHz
LSBW	-3dB Bandwidth Large Signal	$V_{OUT} = 4.0 V_{PP}$	LMH6723	90	110	MHz
			LMH6724	85	95	
			LMH6725			
UGBW	-3 dB Bandwidth Unity Gain	$V_{OUT} = .2 V_{PP}$ $A_V = 1 V/V$		370		MHz
.1dB BW	.1 dB Bandwidth	$V_{OUT} = 0.5 V_{PP}$		100		MHz
DG	Differential Gain	$R_L = 150\Omega$ , 4.43 MHz		0.03		%
DP	Differential Phase	$R_L = 150\Omega$ , 4.43 MHz		0.11		deg
<b>Time Domain Response</b>						
TRS	Rise and Fall Time	4V Step		2.5		ns
TSS	Settling Time to 0.05%	2V Step		30		ns
SR	Slew Rate	4V Step	500	600		V/ $\mu$ s
<b>Distortion and Noise Response</b>						
HD2	2 <sup>nd</sup> Harmonic Distortion	2 $V_{PP}$ , 5 MHz		-65		dBc
HD3	3 <sup>rd</sup> Harmonic Distortion	2 $V_{PP}$ , 5 MHz		-63		dBc
<b>Equivalent Input Noise</b>						
VN	Non-Inverting Voltage Noise	>1 MHz		4.3		nV/ $\sqrt{Hz}$
NICN	Inverting Current Noise	>1 MHz		6		pA/ $\sqrt{Hz}$
ICN	Non-Inverting Current Noise	>1 MHz		6		pA/ $\sqrt{Hz}$
<b>Static, DC Performance</b>						
$V_{IO}$	Input Offset Voltage			1	$\pm 3$ <b><math>\pm 3.7</math></b>	mV
$I_{BN}$	Input Bias Current	Non-Inverting		-2	$\pm 4$ <b><math>\pm 5</math></b>	$\mu$ A
$I_{BI}$	Input Bias Current	Inverting		0.4	$\pm 4$ <b><math>\pm 5</math></b>	$\mu$ A
PSRR	Power Supply Rejection Ratio	DC, 1V Step	LMH6723	59 <b>57</b>	64	dB
			LMH6724	59 <b>55</b>	64	
			LMH6725	59 <b>56</b>	64	

**±5V Electrical Characteristics** (Continued)Unless otherwise specified,  $A_V = +2$ ,  $R_F = 1200\Omega$ ,  $R_L = 100\Omega$ . **Boldface** limits apply at temperature extremes. (Note 2)

Symbol	Parameter	Conditions	Min	Typ	Max	Units
CMRR	Common Mode Rejection Ratio	DC, 1V Step	LMH6723	57 <b>55</b>	60	dB
			LMH6724	57 <b>53</b>	60	
			LMH6725	57 <b>54</b>	60	
$I_{CC}$	Supply Current (per amplifier)	$R_L = \infty$		1	1.2 <b>1.4</b>	mA
<b>Miscellaneous Performance</b>						
$R_{IN+}$	Input Resistance	Non-Inverting		100		k $\Omega$
$R_{IN-}$	Input Resistance (Output Resistance of Input Buffer)	Inverting		500		$\Omega$
$C_{IN}$	Input Capacitance	Non-Inverting		1.5		pF
$R_{OUT}$	Output Resistance	Closed Loop		0.01		$\Omega$
$V_O$	Output Voltage Range	$R_L = \infty$	LMH6723	$\pm 4$ <b><math>\pm 3.9</math></b>	$\pm 4.1$	V
			LMH6724	$\pm 4$ <b><math>\pm 3.85</math></b>	$\pm 4.1$	
			LMH6725	$\pm 4$ <b><math>\pm 3.85</math></b>	$\pm 4.1$	
$V_{OL}$	Output Voltage Range, High	$R_L = 100\Omega$	3.6 <b>3.5</b>	3.7		V
	Output Voltage Range, Low	$R_L = 100\Omega$	-3.25 <b>-3.1</b>	-3.45		
CMVR	Input Voltage Range	Common Mode, CMRR > 50 dB	$\pm 4.0$			V
$I_O$	Output Current	Sourcing, $V_{OUT} = 0$	95 <b>70</b>	110		mA
		Sinking, $V_{OUT} = 0$	-80 <b>-70</b>	110		

**±2.5V Electrical Characteristics**Unless otherwise specified,  $A_V = +2$ ,  $R_F = 1200\Omega$ ,  $R_L = 100\Omega$ . **Boldface** limits apply at temperature extremes. (Note 2)

Symbol	Parameter	Conditions	Min	Typ	Max	Units
<b>Frequency Domain Response</b>						
SSBW	-3 dB Bandwidth Small Signal	$V_{OUT} = 0.5 V_{PP}$		210		MHz
LSBW	-3 dB Bandwidth Large Signal	$V_{OUT} = 2.0 V_{PP}$	LMH6723	95	125	MHz
			LMH6724			
			LMH6725	90	100	
UGBW	-3 dB Bandwidth Unity Gain	$V_{OUT} = 0.5 V_{PP}$ , $A_V = 1 V/V$		290		MHz
.1dB BW	.1 dB Bandwidth	$V_{OUT} = 0.5 V_{PP}$		100		MHz
DG	Differential Gain	$R_L = 150\Omega$ , 4.43 MHz		.03		%
DP	Differential Phase	$R_L = 150\Omega$ , 4.43 MHz		0.1		deg
<b>Time Domain Response</b>						
TRS	Rise and Fall Time	2V Step		4		ns
SR	Slew Rate	2V Step	275	400		V/ $\mu$ s
<b>Distortion and Noise Response</b>						
HD2	2 <sup>nd</sup> Harmonic Distortion	2 $V_{PP}$ , 5 MHz		-67		dBc
HD3	3 <sup>rd</sup> Harmonic Distortion	2 $V_{PP}$ , 5 MHz		-67		dBc
<b>Equivalent Input Noise</b>						
VN	Non-Inverting Voltage	>1 MHz		4.3		nV/ $\sqrt{\text{Hz}}$

**±2.5V Electrical Characteristics** (Continued)Unless otherwise specified,  $A_V = +2$ ,  $R_F = 1200\Omega$ ,  $R_L = 100\Omega$ . **Boldface** limits apply at temperature extremes. (Note 2)

Symbol	Parameter	Conditions		Min	Typ	Max	Units
NICN	Inverting Current	>1MHz			6		pA/√Hz
ICN	Non-Inverting Current	>1MHz			6		pA/√Hz
<b>Static, DC Performance</b>							
$V_{IO}$	Input Offset Voltage				-0.5	$\pm 3$ <b><math>\pm 3.4</math></b>	mV
$I_{BN}$	Input Bias Current	Non-Inverting			-2.7	$\pm 4$ <b><math>\pm 5</math></b>	$\mu A$
$I_{BI}$	Input Bias Current	Inverting			-0.7	$\pm 4$ <b><math>\pm 5</math></b>	$\mu A$
PSRR	Power Supply Rejection Ratio	DC, 0.5V Step	LMH6723	59 <b>57</b>	62		dB
			LMH6724	58 <b>55</b>	62		
			LMH6725	59 <b>56</b>	62		
CMRR	Common Mode Rejection Ratio	DC, 0.5V Step	LMH6723	57 <b>53</b>	59		dB
			LMH6724	55 <b>52</b>	59		
			LMH6725	57 <b>52</b>	59		
$I_{CC}$	Supply Current (per amplifier)	$R_L = \infty$			.9	1.1 <b>1.3</b>	mA
<b>Miscellaneous Performance</b>							
$R_{IN+}$	Input Resistance	Non-Inverting			100		k $\Omega$
$R_{IN-}$	Input Resistance (Output Resistance of Input Buffer)	Inverting			500		$\Omega$
$C_{IN}$	Input Capacitance	Non-Inverting			1.5		pF
$R_{OUT}$	Output Resistance	Closed Loop			.02		$\Omega$
$V_O$	Output Voltage Range	$R_L = \infty$		$\pm 1.55$ <b><math>\pm 1.4</math></b>	$\pm 1.65$		V
$V_{OL}$	Output Voltage Range, High	$R_L = 100\Omega$	LMH6723	1.35 <b>1.27</b>	1.45		V
			LMH6724 LMH6725	1.35 <b>1.26</b>	1.45		
	Output Voltage Range, Low	$R_L = 100\Omega$	LMH6723	-1.25 <b>-1.15</b>	-1.38		V
			LMH6724 LMH6725	-1.25 <b>-1.15</b>	-1.38		
CMVR	Input Voltage Range	Common Mode, CMRR > 50 dB		$\pm 1.45$			V
$I_O$	Output Current	Sourcing		70 <b>60</b>	90		mA
		Sinking		-30 <b>-30</b>	-60		

**Note 1:** Absolute Maximum Ratings indicate limits beyond which damage to the device may occur. Operating Ratings indicate conditions for which the device is intended to be functional, but specific performance is not guaranteed. For guaranteed specifications, see the Electrical Characteristics tables.

**Note 2:** Electrical Table values apply only for factory testing conditions at the temperature indicated. Factory testing conditions result in very limited self-heating of the device such that  $T_J = T_A$ . No guarantee of parametric performance is indicated in the electrical tables under conditions of internal self heating where  $T_J > T_A$ . See Applications Section for information on temperature derating of this device. Min/Max ratings are based on product characterization and simulation. Individual parameters are tested as noted.

**Note 3:** The maximum continuous output current ( $I_{OUT}$ ) is determined by device power dissipation limitations. See the Power Dissipation section of the Application Section for more details.

**Note 4:** Human Body Model, 1.5 k $\Omega$  in series with 100 pF. Machine Model, 0 $\Omega$  In series with 200 pF.

## Connection Diagrams

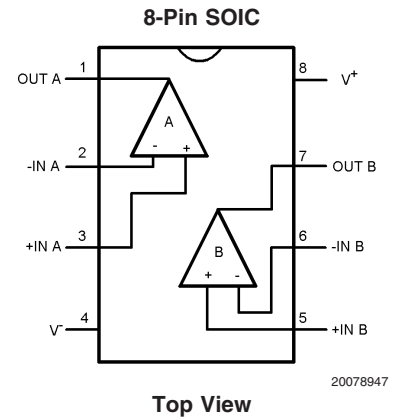
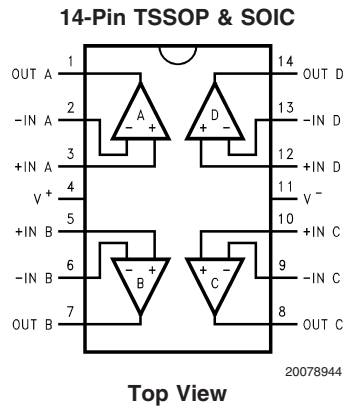
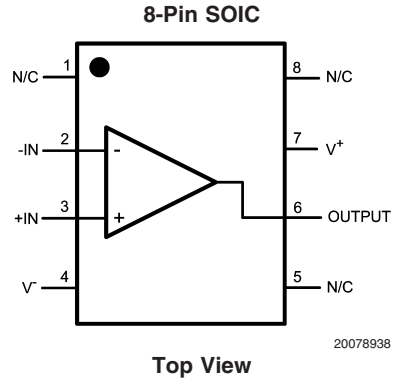
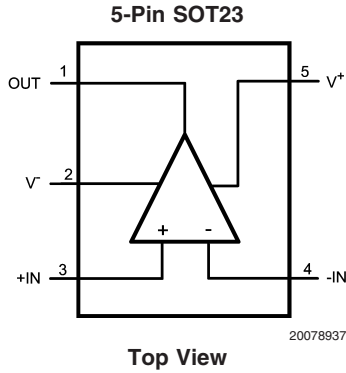

## Ordering Information

Package	Part Number	Package Marking	Transport Media	NSC Drawing
5-Pin SOT23	LMH6723MF	AB1A	1k Units Tape and Reel	MF05A
	LMH6723MFX		3k Units Tape and Reel	
8-Pin SOIC	LMH6723MA	LMH6723MA	95 Units/Rail	M08A
	LMH6723MAX		2.5k Units Tape and Reel	
8-Pin SOIC	LMH6724MA	LMH6724MA	95 Units/Rail	M08A
	LMH6724MAX		2.5k Units Tape and Reel	
14-Pin SOIC	LMH6725MA	LMH6725MA	55 Units/Rail	M14A
	LMH6725MAX		2.5k Units Tape and Reel	
14-Pin TSSOP	LMH6725MT	LMH6725MT	94 Units/Rail	MTC14
	LMH6725MTX		2.5k Units Tape and Reel	

**Typical Performance Characteristics**  $A_V = 2, R_F = 1200\Omega, R_L = 100\Omega$ , unless otherwise specified.

**Frequency Response vs.  $V_{OUT}$ ,  $A_V = 2$**

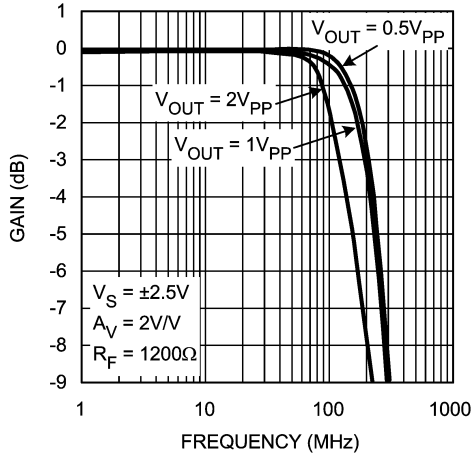

20078928

**Frequency Response vs.  $V_{OUT}$ ,  $A_V = 2$**

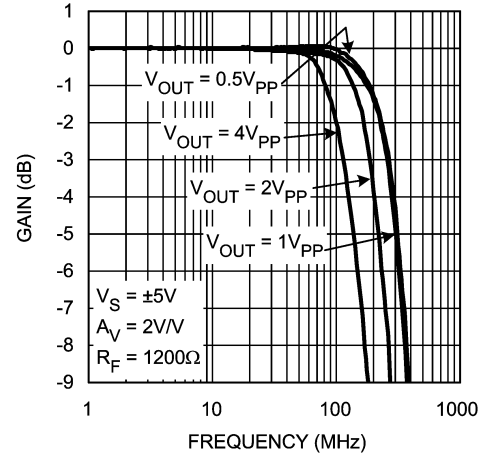

20078926

**Frequency Response vs.  $V_{OUT}$ ,  $A_V = 1$**

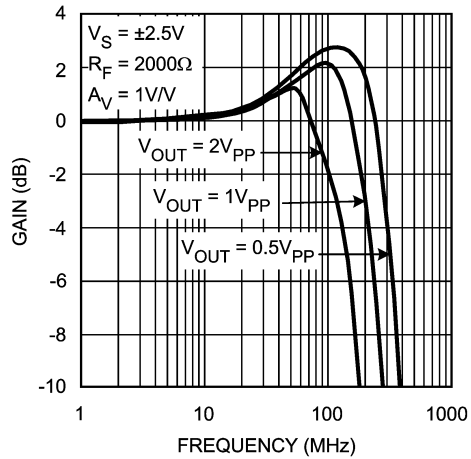

20078929

**Frequency Response vs.  $V_{OUT}$ ,  $A_V = 1$**

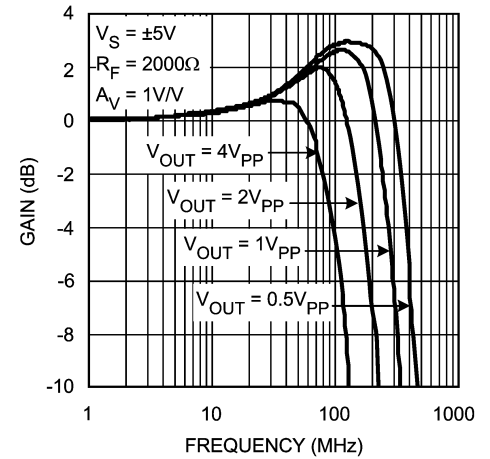

20078927

**Large Signal Frequency Response**

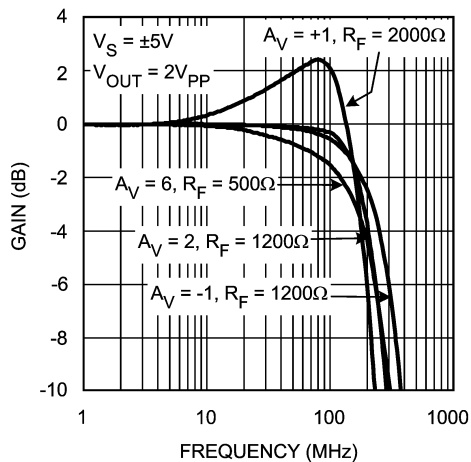

20078921

**Frequency Response vs. Supply Voltage**

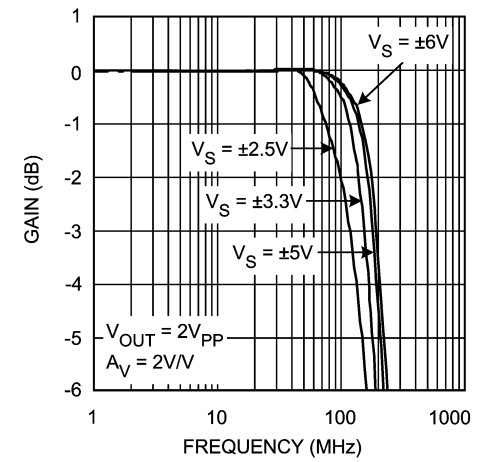

20078930

## Typical Performance Characteristics $A_V = 2$ , $R_F = 1200\Omega$ , $R_L = 100\Omega$ , unless otherwise specified. (Continued)

**Suggested  $R_F$  vs. Gain Non-Inverting**

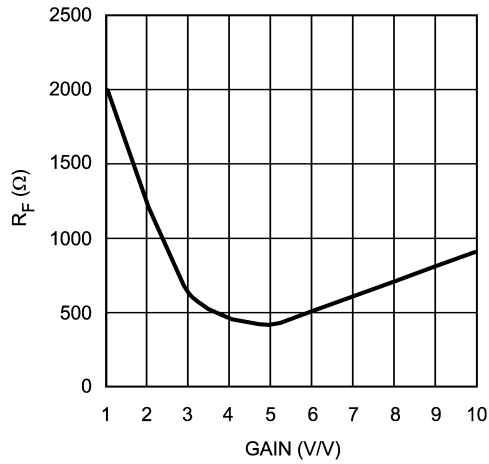

20078905

**Suggested  $R_F$  vs. Gain Inverting**

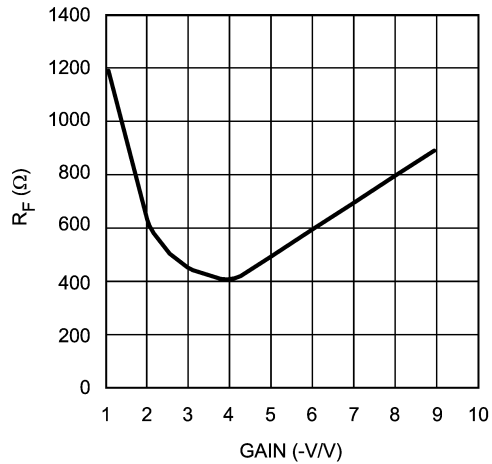

20078906

**Frequency Response vs.  $R_F$**

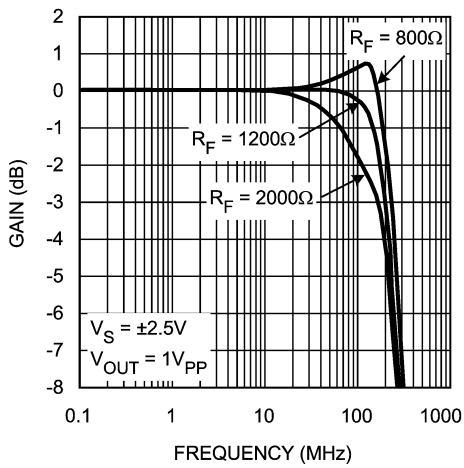

20078922

**Frequency Response vs.  $R_F$**

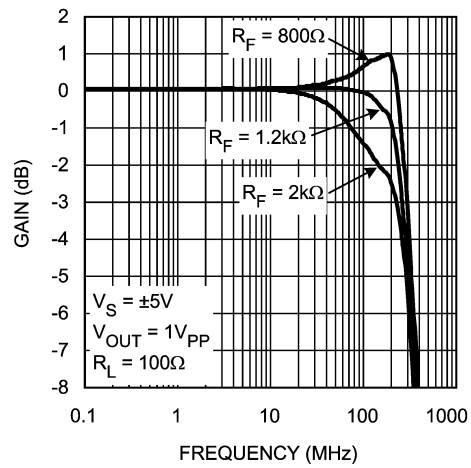

20078923

**Open Loop Gain & Phase**

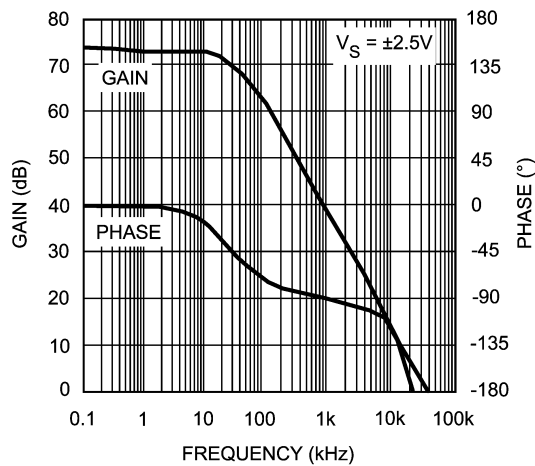

20078917

**Open Loop Gain & Phase**

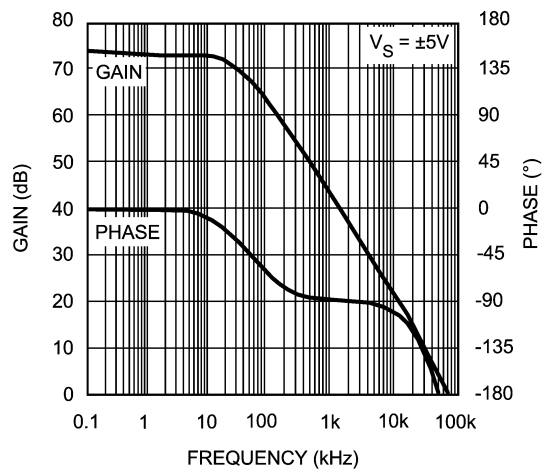

20078918

**Typical Performance Characteristics**  $A_V = 2$ ,  $R_F = 1200\Omega$ ,  $R_L = 100\Omega$ , unless otherwise specified. (Continued)

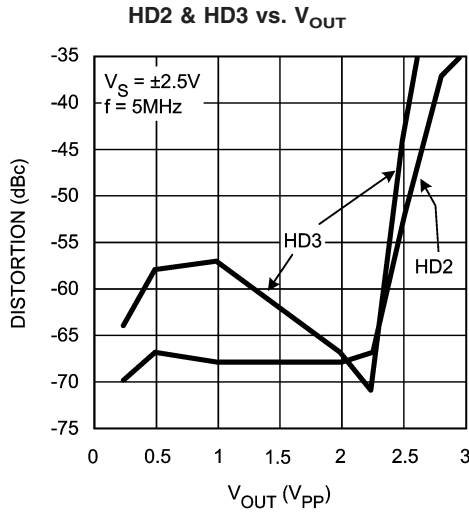

20078911

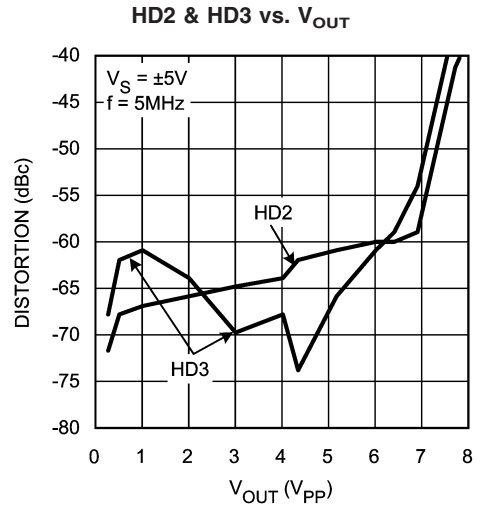

20078913

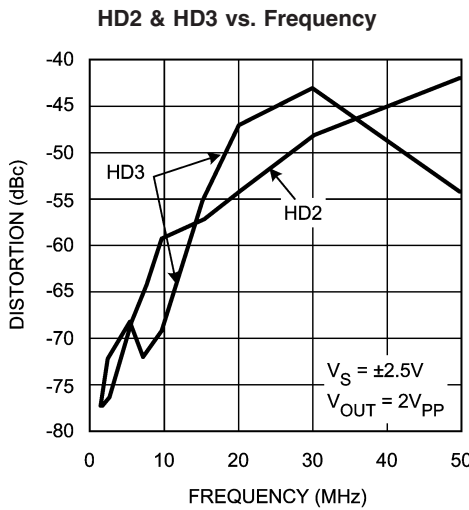

20078912

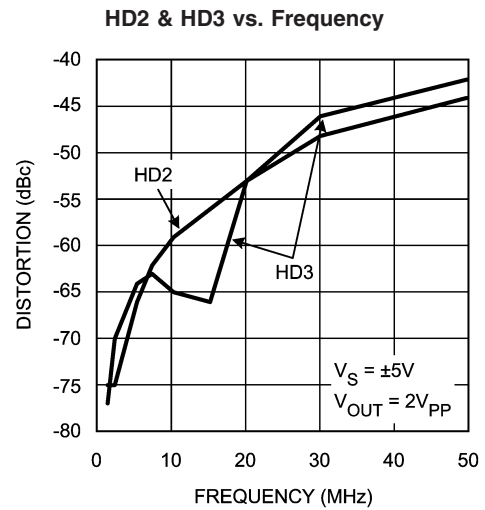

20078914

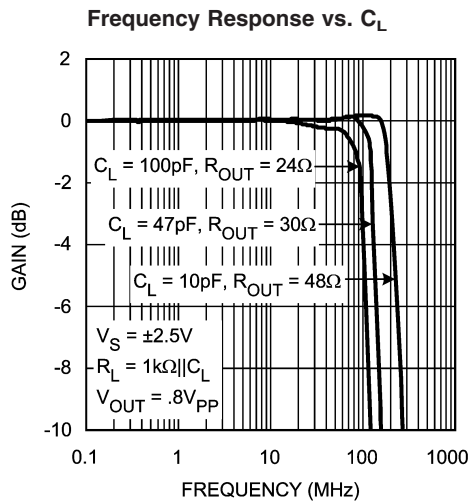

20078925

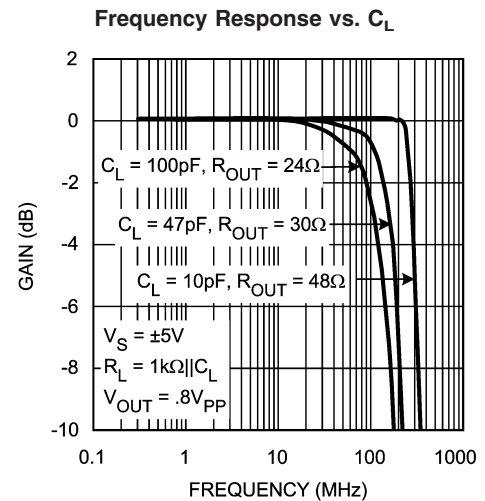

20078924



**Typical Performance Characteristics**  $A_V = 2$ ,  $R_F = 1200\Omega$ ,  $R_L = 100\Omega$ , unless otherwise specified. (Continued)

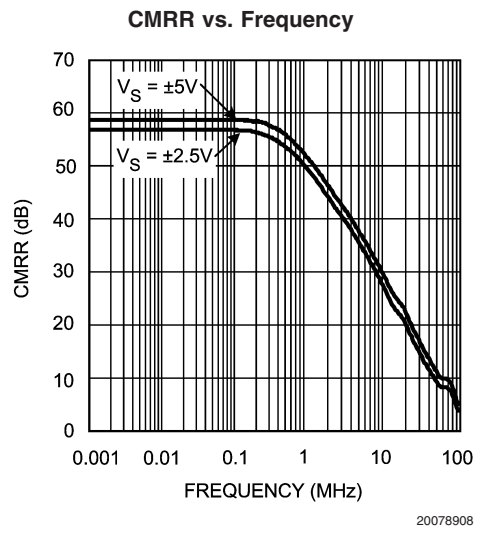
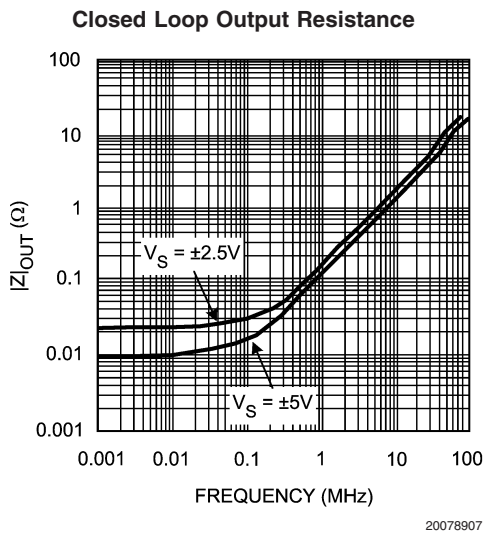
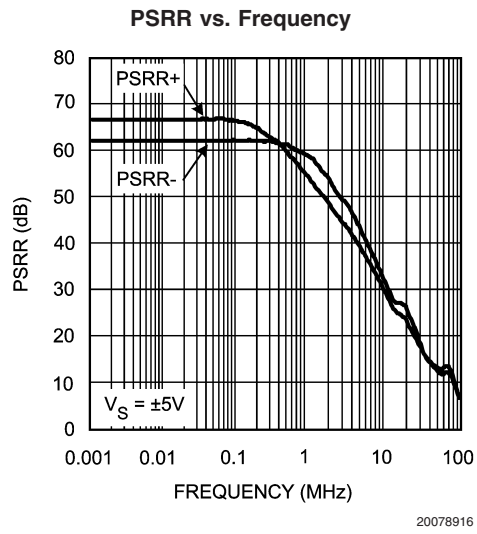
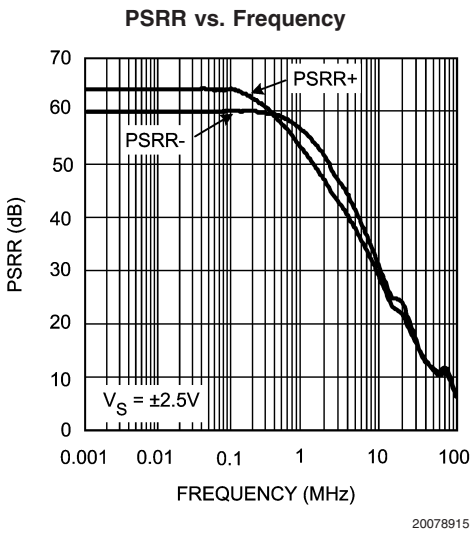
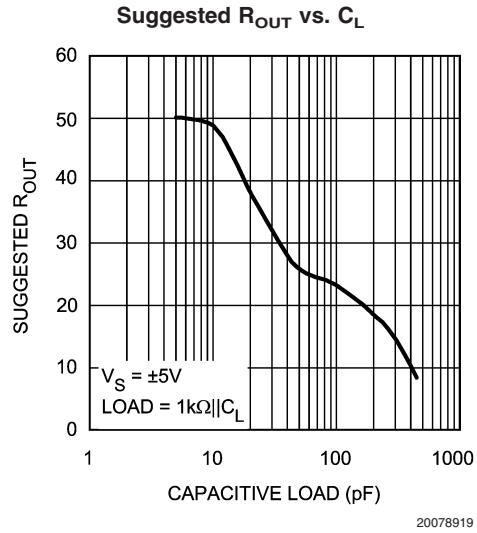
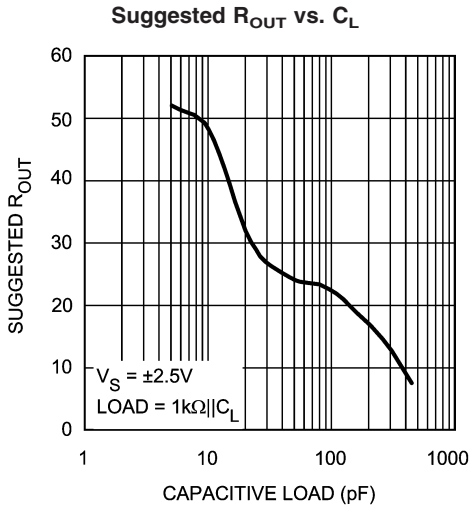

# Typical Performance Characteristics $A_V = 2$ , $R_F = 1200\Omega$ , $R_L = 100\Omega$ , unless otherwise specified. (Continued)

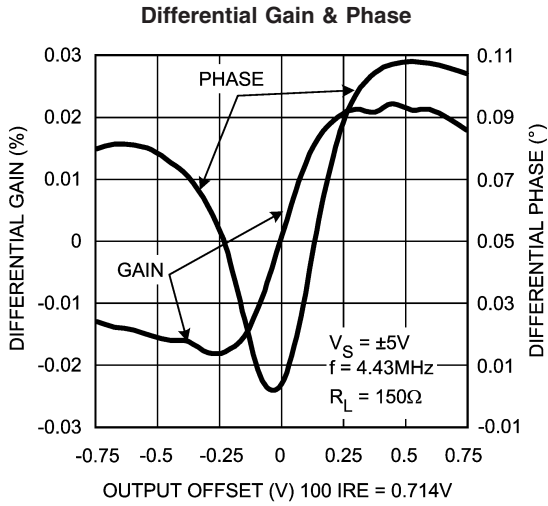

20078910

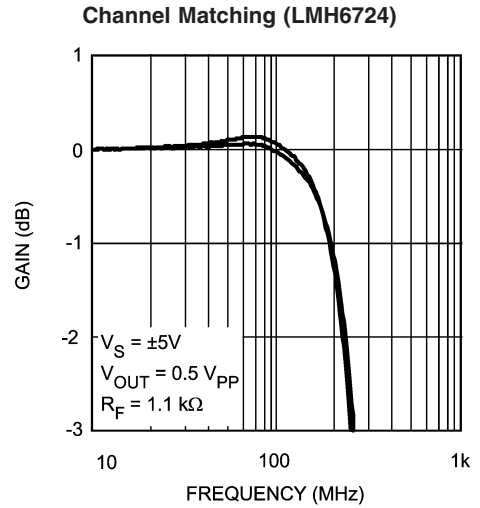

20078948

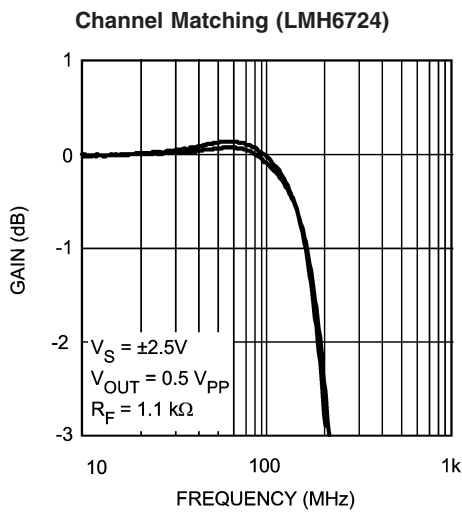

20078949

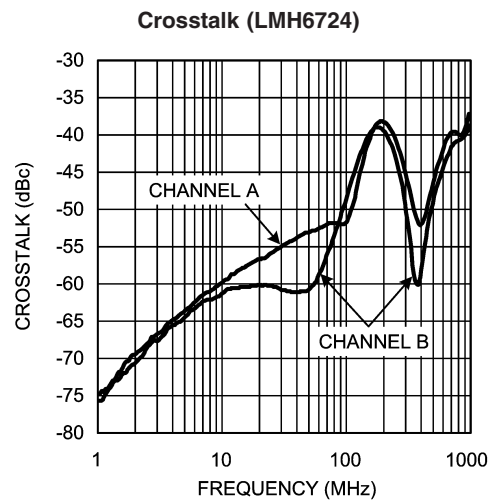

20078946

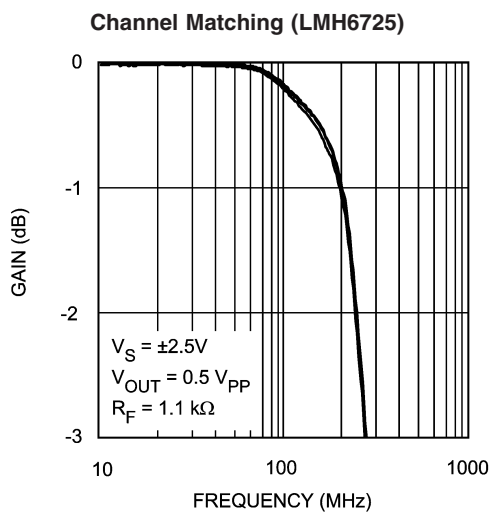

20078940

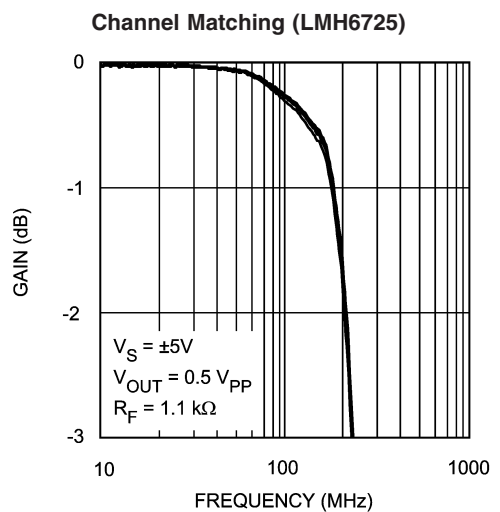

20078941

## Typical Performance Characteristics $A_V = 2$ , $R_F = 1200\Omega$ , $R_L = 100\Omega$ , unless otherwise specified. (Continued)

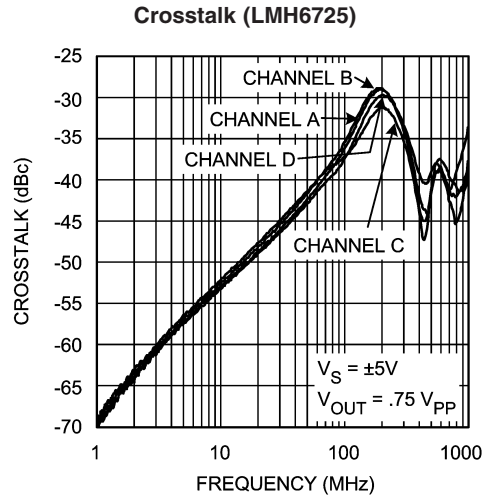

20078945

## Application Section

### GENERAL INFORMATION

The LMH6723/LMH6724/LMH6725 is a high speed current feedback amplifier manufactured on National Semiconductor's VIP10 (Vertically Integrated PNP) complimentary bipolar process. LMH6723/LMH6724/LMH6725 offers a unique combination of high speed and low quiescent supply current making it suitable for a wide range of battery powered and portable applications that require high performance. This amplifier can operate from 4.5V to 12V nominal supply voltages and draws only 1 mA of quiescent supply current at 10V supplies ( $\pm 5V$  typically). The LMH6723/LMH6724/LMH6725 has no internal ground reference so single or split supply configurations are both equally useful.

### EVALUATION BOARDS

National Semiconductor provides the following evaluation boards as a guide for high frequency layout and as an aid in device testing and characterization. Many of the datasheet plots were measured with these boards.

Device	Package	Board Part #
LMH6723MA	SOIC-8	CLC730227
LMH6723MF	SOT-23	CLC730216
LMH6724MA	SOIC-8	CLC730036
LMH6725MA	SOIC-14	CLC730231

These evaluation boards can be shipped when a device sample request is placed with National Semiconductor.

### FEEDBACK RESISTOR SELECTION

One of the key benefits of a current feedback operational amplifier is the ability to maintain optimum frequency response independent of gain by using appropriate values for the feedback resistor ( $R_F$ ). The Electrical Characteristics and Typical Performance plots were generated with an  $R_F$  of  $1200\Omega$ , a gain of  $+2V/V$  and  $\pm 5V$  or  $\pm 2.5V$  power supplies (unless otherwise specified). Generally, lowering  $R_F$  from its recommended value will peak the frequency response and extend the bandwidth; however, increasing the value of  $R_F$

will cause the frequency response to roll off faster. Reducing the value of  $R_F$  too far below its recommended value will cause overshoot, ringing and, eventually, oscillation.

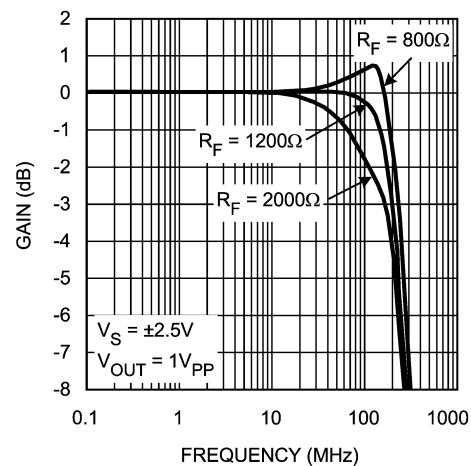

20078922

**FIGURE 1. Frequency Response vs.  $R_F$**

Figure 1 shows the LMH6723/LMH6724/LMH6725's frequency response as  $R_F$  is varied ( $R_L = 100\Omega$ ,  $A_V = +2$ ). This plot shows that an  $R_F$  of  $800\Omega$  results in peaking. An  $R_F$  of  $1200\Omega$  gives near maximal bandwidth and gain flatness with good stability. Since each application is slightly different it is worth some experimentation to find the optimal  $R_F$  for a given circuit. In general a value of  $R_F$  that produces  $\sim 0.1$  dB of peaking is the best compromise between stability and maximal bandwidth. Note that it is not possible to use a current feedback amplifier with the output shorted directly to the inverting input. The buffer configuration of the LMH6723/LMH6724/LMH6725 requires a  $2000\Omega$  feedback resistor for stable operation. For other gains see the charts " $R_F$  vs. Non

## Application Section (Continued)

Inverting Gain" and "R<sub>F</sub> vs. Inverting Gain". These charts provide a good place to start when selecting the best feedback resistor value for a variety of gain settings.

For more information see Application Note OA-13 which describes the relationship between R<sub>F</sub> and closed-loop frequency response for current feedback operational amplifiers. The value for the inverting input impedance for the LMH6723/LMH6724/LMH6725 is approximately 500Ω. The LMH6723/LMH6724/LMH6725 is designed for optimum performance at gains of +1 to +5V/V and -1 to -4V/V. Higher gain configurations are still useful; however, the bandwidth will fall as gain is increased, much like a typical voltage feedback amplifier.

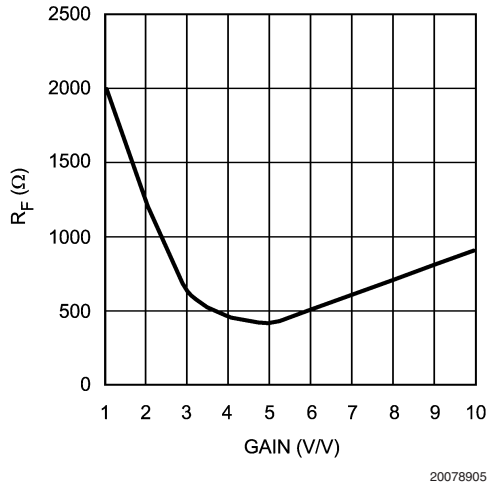
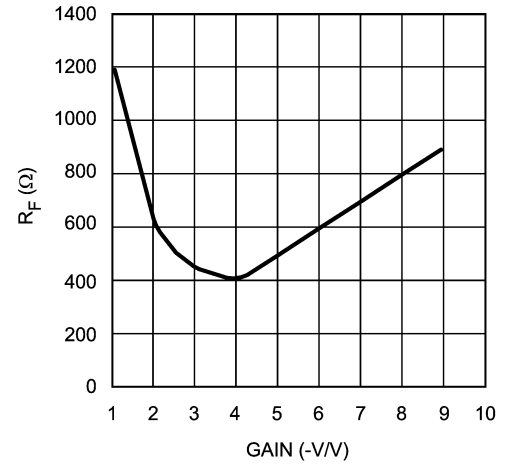

FIGURE 2. RF vs. Non-Inverting Gain

Figure 2 and Figure 3 show the value of R<sub>F</sub> versus gain. A higher R<sub>F</sub> is required at higher gains to keep R<sub>G</sub> from decreasing too far below the input impedance of the inverting input. This limitation applies to both inverting and non-inverting configurations. For the LMH6723/LMH6724/LMH6725 the input resistance of the inverting input is approximately 500Ω and 100Ω is a practical lower limit for R<sub>G</sub>. The LMH6723/LMH6724/LMH6725 begins to operate in a gain bandwidth limited fashion in the region where R<sub>F</sub> must be increased for higher gains. Note that the amplifier will operate with R<sub>G</sub> values well below 100Ω; however, results will be substantially different than predicted from ideal models. In particular, the voltage potential between the Inverting and Non-Inverting inputs cannot be expected to remain small.

For inverting configurations the impedance seen by the source is R<sub>G</sub> || R<sub>F</sub>. For most sources this limits the maximum inverting gain since R<sub>F</sub> is determined by the desired gain as shown in Figure 3. The value of R<sub>G</sub> is then R<sub>F</sub>/Gain. Thus for an inverting gain of -4 V/V the input impedance is equal to 100Ω. Using a termination resistor, this can be brought down to match a 50Ω or 75Ω source; however, a 150Ω source cannot be matched without a severe compromise in R<sub>F</sub>.



20078906

FIGURE 3. R<sub>F</sub> vs. Inverting Gain

### ACTIVE FILTERS

When using any current feedback operational amplifier as an active filter it is necessary to be careful using reactive components in the feedback loop. Reducing the feedback impedance, especially at higher frequencies, will almost certainly cause stability problems. Likewise capacitance on the inverting input should be avoided. See Application Notes OA-7 and OA-26 for more information on Active Filter applications for Current Feedback Op Amps.

When using the LMH6723/LMH6724/LMH6725 as a low-pass filter the value of R<sub>F</sub> can be substantially reduced from the value recommended in the R<sub>F</sub> vs. Gain charts. The benefit of reducing R<sub>F</sub> is increased gain at higher frequencies, which improves attenuation in the stop band. Stability problems are avoided because in the stop band additional device bandwidth is used to cancel the input signal rather than amplify it. The benefit of this change depends on the particulars of the circuit design. With a high pass filter configuration reducing R<sub>F</sub> will likely result in device instability and is not recommended.

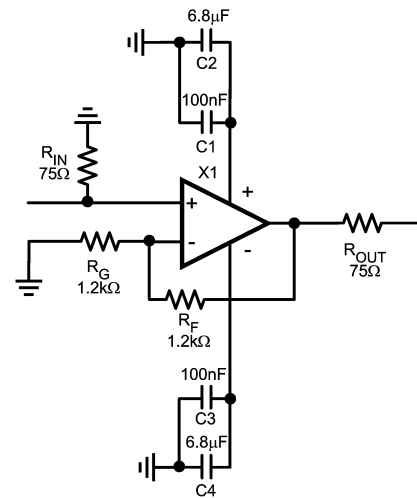

20078933

FIGURE 4. Typical Application with Suggested Supply Bypassing

## Application Section (Continued)

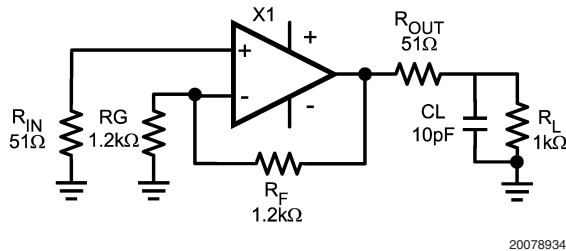

FIGURE 5. Decoupling Capacitive Loads

### DRIVING CAPACITIVE LOADS

Capacitive output loading applications will benefit from the use of a series output resistor as shown in *Figure 5*. The charts "Suggested  $R_{OUT}$  vs. Cap Load" give a recommended value for selecting a series output resistor for mitigating capacitive loads. The values suggested in the charts are selected for .5 dB or less of peaking in the frequency response. This gives a good compromise between settling time and bandwidth. For applications where maximum frequency response is needed and some peaking is tolerable, the value of  $R_{OUT}$  can be reduced slightly from the recommended values.

There will be amplitude lost in the series resistor unless the gain is adjusted to compensate; this effect is most noticeable with heavy loads ( $R_L < 150\Omega$ ).

An alternative approach is to place  $R_{OUT}$  inside the feedback loop as shown in *Figure 6*. This will preserve gain accuracy, but will still limit maximum output voltage swing.

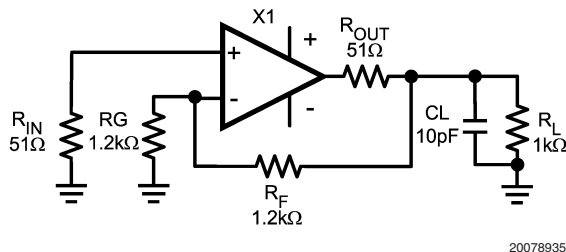

FIGURE 6. Series Output Resistor inside feedback loop

### INVERTING INPUT PARASITIC CAPACITANCE

Parasitic capacitance is any capacitance in a circuit that was not intentionally added. It is produced through electrical interaction between conductors and can be reduced but never entirely eliminated. Most parasitic capacitances that cause problems are related to board layout or lack of termination on transmission lines. Please see the section on Layout Considerations for hints on reducing problems due to parasitic capacitances on board traces. Transmission lines should be terminated in their characteristic impedance at both ends.

High speed amplifiers are sensitive to capacitance between the inverting input and ground or power supplies. This shows up as gain peaking at high frequency. The capacitor raises device gain at high frequencies by making  $R_G$  appear smaller. Capacitive output loading will exaggerate this effect.

One possible remedy for this effect is to slightly increase the value of the feedback (and gain set) resistor. This will tend to offset the high frequency gain peaking while leaving other parameters relatively unchanged. If the device has a capacitive load as well as inverting input capacitance, using a series output resistor as described in the section on "Driving Capacitive Loads" will help.

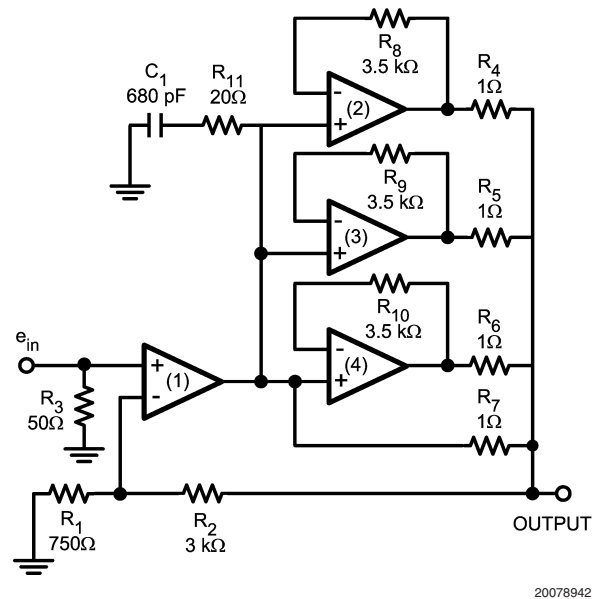

FIGURE 7. High Output Current Composite Amplifier

When higher currents are required than a single amplifier can provide, the circuit of *Figure 7* can be used. Although the example circuit was intended for the LMH6725 quad op amp, higher thermal efficiency can be obtained by using four separate SOIC op amps. Careful attention to a few key components will optimize performance from this circuit. The first thing to note is that the buffers need slightly higher value feedback resistors than if the amplifiers were individually configured. As well,  $R_{11}$  and  $C_1$  provide mid circuit frequency compensation to further improve stability. The composite amplifier has approximately twice the phase delay of a single circuit. The larger values of  $R_8$ ,  $R_9$  and  $R_{10}$ , as well as the high frequency attenuation provided by  $C_1$  and  $R_{11}$ , ensure that the circuit does not oscillate.

Resistors  $R_4$ ,  $R_5$ ,  $R_6$ , and  $R_7$  are necessary to ensure even current distribution between the amplifiers. Since they are inside the feedback loop they have no effect on the gain of the circuit. The circuit shown in *Figure 7* has a gain of 5. The frequency response of this circuit is shown in *Figure 8*.

## Application Section (Continued)

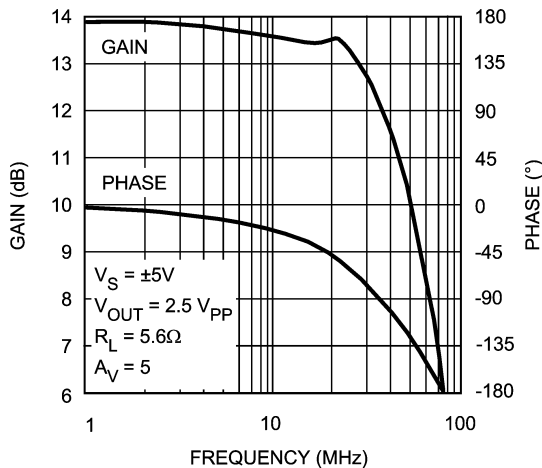

FIGURE 8. Composite Amplifier Frequency Response

### LAYOUT CONSIDERATIONS

Whenever questions about layout arise, use the evaluation board as a guide. Evaluation boards are shipped with sample requests.

To reduce parasitic capacitances ground and power planes should be removed near the input and output pins. Components in the feedback loop should be placed as close to the device as possible. For long signal paths controlled impedance lines should be used, along with impedance matching at both ends.

Bypass capacitors should be placed as close to the device as possible. Bypass capacitors from each rail to ground are applied in pairs. The larger electrolytic bypass capacitors can be located anywhere on the board; however, the smaller ceramic capacitors should be placed as close to the device as possible.

### VIDEO PERFORMANCE

The LMH6723/LMH6724/LMH6725 has been designed to provide good performance with both PAL and NTSC composite video signals. The LMH6723/LMH6724/LMH6725 is specified for PAL signals. Typically, NTSC performance is marginally better due to the lower frequency content of the signal. Performance degrades as the loading is increased;

therefore, best performance will be obtained with back terminated loads. The back termination reduces reflections from the transmission line and effectively masks transmission line and other parasitic capacitances from the amplifier output stage. Figure 4 shows a typical configuration for driving a 75Ω cable. The amplifier is configured for a gain of 2 to make up for the 6dB of loss in  $R_{OUT}$ .

### SINGLE 5V SUPPLY VIDEO

With a 5V supply the LMH6723/LMH6724/LMH6725 is able to handle a composite NTSC video signal, provided that the signal is AC coupled and level shifted so that the signal is centered around  $V_{CC}/2$ .

### POWER DISSIPATION

Follow these steps to determine the maximum power dissipation for the LMH6723/LMH6724/LMH6725:

1. Calculate the quiescent (no-load) power:  $P_{AMP} = I_{CC} \cdot (V_S) V_S = V^+ - V^-$
2. Calculate the RMS power dissipated in the output stage:  $P_D (rms) = rms ((V_S - V_{OUT}) \cdot I_{OUT})$  where  $V_{OUT}$  and  $I_{OUT}$  are the voltage and current across the external load and  $V_S$  is the total supply current.
3. Calculate the total RMS power:  $P_T = P_{AMP} + P_D$

The maximum power that the LMH6723/LMH6724/LMH6725 package can dissipate at a given temperature can be derived with the following equation:

$P_{MAX} = (150^\circ - T_{AMB}) / \theta_{JA}$ , where  $T_{AMB}$  = Ambient temperature ( $^\circ C$ ) and  $\theta_{JA}$  = Thermal resistance, from junction to ambient, for a given package ( $^\circ C/W$ ). For the SOIC-8 package  $\theta_{JA}$  is  $166^\circ C/W$  and for the SOT it is  $230^\circ C/W$ . The SOIC-14 has a  $\theta_{JA}$  of  $130^\circ C/W$ . The TSSOP-14 has a  $\theta_{JA}$  of  $160^\circ C/W$ .

### ESD PROTECTION

The LMH6723/LMH6724/LMH6725 is protected against electrostatic discharge (ESD) on all pins. The LMH6723/LMH6725 will survive 2000V Human Body Model or 200V Machine Model events.

Under closed loop operation the ESD diodes have no effect on circuit performance. There are occasions, however, when the ESD diodes will be evident. If the LMH6723/LMH6724/LMH6725 is driven into a slewing condition the ESD diodes will clamp large differential voltages until the feedback loop restores closed loop operation. Also, if the device is powered down and a large input signal is applied, the ESD diodes will conduct.

# Physical Dimensions inches (millimeters)

unless otherwise noted

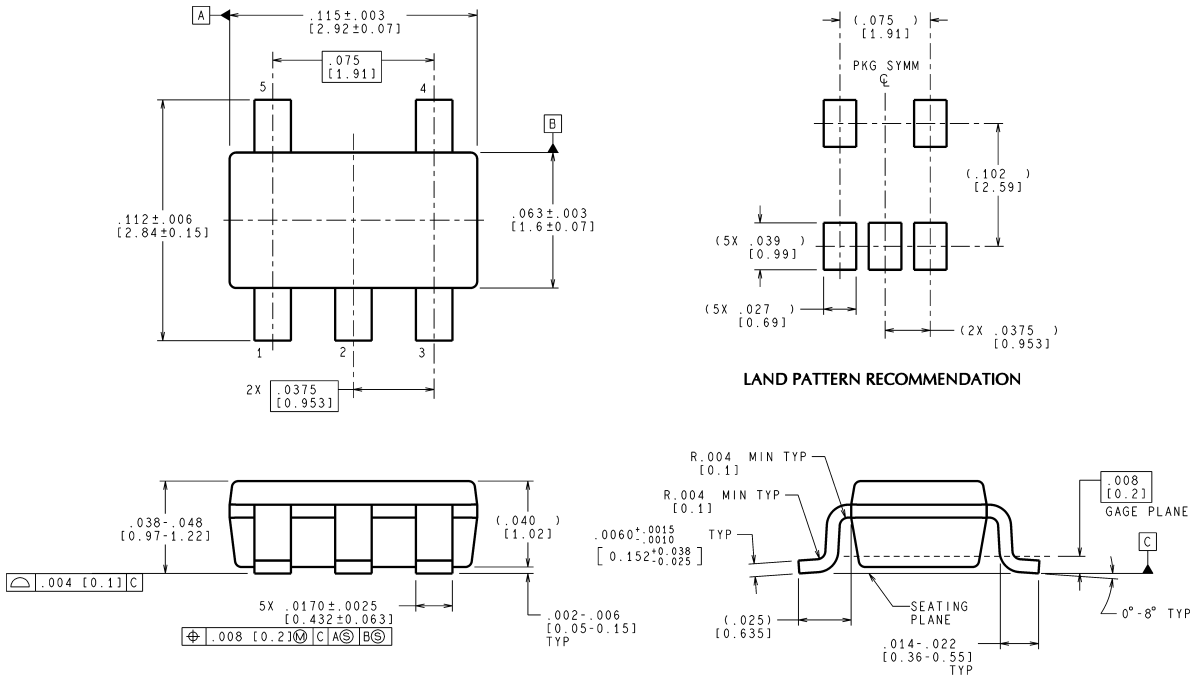

**5-Pin SOT23  
NS Product Number MF05A**

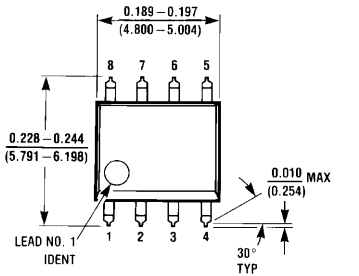

**8-Pin SOIC  
NS Product Number M08A**

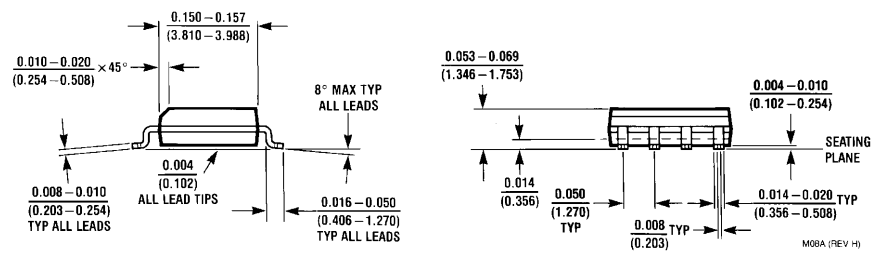

**Physical Dimensions** inches (millimeters) unless otherwise noted (Continued)

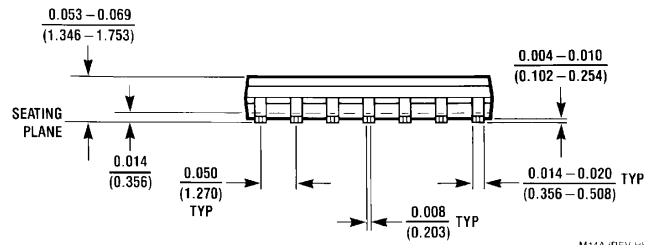
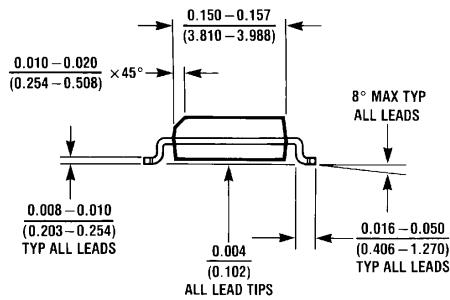
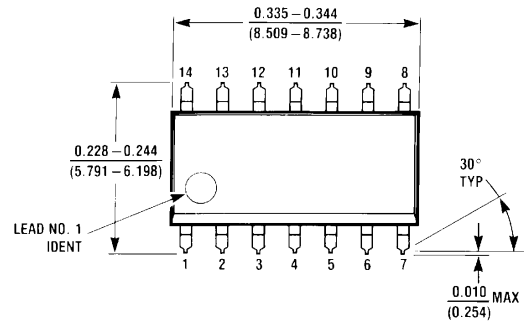

M14A (REV H)

**14-Pin SOIC  
NS Product Number M14A**

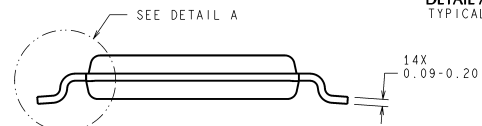
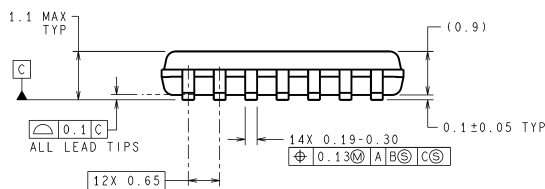
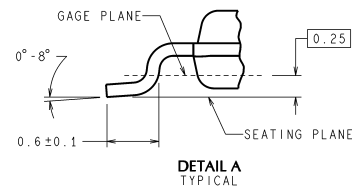
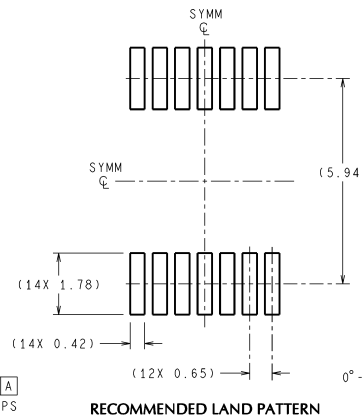
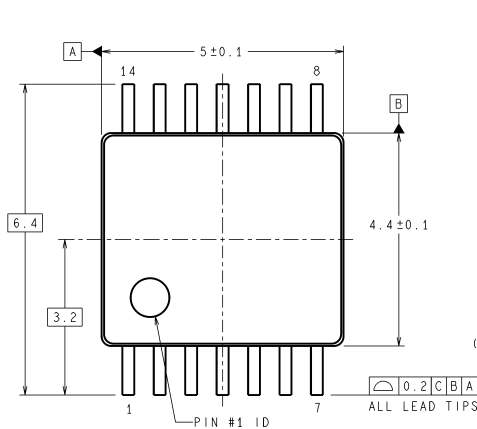

**DIMENSIONS ARE IN MILLIMETERS**  
DIMENSIONS IN ( ) FOR REFERENCE ONLY

MTC14 (Rev D)

**14-Pin TSSOP  
NS Product Number MTC14**



## Notes

National does not assume any responsibility for use of any circuitry described, no circuit patent licenses are implied and National reserves the right at any time without notice to change said circuitry and specifications.  
 For the most current product information visit us at [www.national.com](http://www.national.com).

### LIFE SUPPORT POLICY

NATIONAL'S PRODUCTS ARE NOT AUTHORIZED FOR USE AS CRITICAL COMPONENTS IN LIFE SUPPORT DEVICES OR SYSTEMS WITHOUT THE EXPRESS WRITTEN APPROVAL OF THE PRESIDENT AND GENERAL COUNSEL OF NATIONAL SEMICONDUCTOR CORPORATION. As used herein:

- |  |   |
|--|---|
| <p>1. Life support devices or systems are devices or systems which, (a) are intended for surgical implant into the body, or (b) support or sustain life, and whose failure to perform when properly used in accordance with instructions for use provided in the labeling, can be reasonably expected to result in a significant injury to the user.</p> | <p>2. A critical component is any component of a life support device or system whose failure to perform can be reasonably expected to cause the failure of the life support device or system, or to affect its safety or effectiveness.</p> |
|--|---|

### BANNED SUBSTANCE COMPLIANCE

National Semiconductor manufactures products and uses packing materials that meet the provisions of the Customer Products Stewardship Specification (CSP-9-111C2) and the Banned Substances and Materials of Interest Specification (CSP-9-111S2) and contain no "Banned Substances" as defined in CSP-9-111S2.

Leadfree products are RoHS compliant.



**National Semiconductor**  
**Americas Customer**  
**Support Center**  
 Email: [new.feedback@nsc.com](mailto:new.feedback@nsc.com)  
 Tel: 1-800-272-9959

[www.national.com](http://www.national.com)

**National Semiconductor**  
**Europe Customer Support Center**  
 Fax: +49 (0) 180-530 85 86  
 Email: [europe.support@nsc.com](mailto:europe.support@nsc.com)  
 Deutsch Tel: +49 (0) 69 9508 6208  
 English Tel: +44 (0) 870 24 0 2171  
 Français Tel: +33 (0) 1 41 91 8790

**National Semiconductor**  
**Asia Pacific Customer**  
**Support Center**  
 Email: [ap.support@nsc.com](mailto:ap.support@nsc.com)

**National Semiconductor**  
**Japan Customer Support Center**  
 Fax: 81-3-5639-7507  
 Email: [jpn.feedback@nsc.com](mailto:jpn.feedback@nsc.com)  
 Tel: 81-3-5639-7560