

## Dual Input, High Speed, Dual Channel Power MOSFET Driver

The EL7242/EL7252 dual input, 2-channel drivers achieve the same excellent switching performance of the EL7212 family while providing added flexibility. The 2-input logic and configuration is applicable to numerous power MOSFET drive circuits. As with other Elantec drivers, the EL7242/EL7252 are excellent for driving large capacitive loads with minimal delay and switching times. "Shoot-thru" protection and latching circuits can be implemented by simply "cross-coupling" the 2-channels.

### Ordering Information

PART NUMBER	PART MARKING	TAPE & REEL	PACKAGE	PKG. DWG. #
EL7242CN	EL7242CN	-	8-Pin PDIP	MDP0031
EL7242CNZ (See Note)	EL7242CNZ	-	8-Pin PDIP* (Pb-free)	MDP0031
EL7242CS	7242CS	-	8-Pin SOIC	MDP0027
EL7242CS-T7	7242CS	7"	8-Pin SOIC	MDP0027
EL7242CS-T13	7242CS	13"	8-Pin SOIC	MDP0027
EL7242CSZ (See Note)	7242CSZ	-	8-Pin SOIC (Pb-free)	MDP0027
EL7242CSZ-T7 (See Note)	7242CSZ	7"	8-Pin SOIC (Pb-free)	MDP0027
EL7242CSZ-T13 (See Note)	7242CSZ	13"	8-Pin SOIC (Pb-free)	MDP0027
EL7252CN	EL7252CN	-	8-Pin PDIP	MDP0031
EL7252CS	7252CS	-	8-Pin SOIC	MDP0027
EL7252CS-T7	7252CS	7"	8-Pin SOIC	MDP0027
EL7252CS-T13	7252CS	13"	8-Pin SOIC	MDP0027
EL7252CSZ (See Note)	7252CSZ	-	8-Pin SOIC (Pb-free)	MDP0027
EL7252CSZ-T7 (See Note)	7252CSZ	7"	8-Pin SOIC (Pb-free)	MDP0027
EL7252CSZ-T13 (See Note)	7252CSZ	13"	8-Pin SOIC (Pb-free)	MDP0027

\*Pb-free PDIPs can be used for through hole wave solder processing only. They are not intended for use in Reflow solder processing applications.

NOTE: Intersil Pb-free plus anneal products employ special Pb-free material sets; molding compounds/die attach materials and 100% matte tin plate termination finish, which are RoHS compliant and compatible with both SnPb and Pb-free soldering operations. Intersil Pb-free products are MSL classified at Pb-free peak reflow temperatures that meet or exceed the Pb-free requirements of IPC/JEDEC J STD-020.

### Features

- Logic AND/NAND input
- 3V and 5V Input compatible
- Clocking speeds up to 10MHz
- 20ns Switching/delay time
- 2A Peak drive
- Isolated drains
- Low output impedance
- Low quiescent current
- Wide operating voltage — 4.5V to 16V
- Pb-free plus anneal available (RoHS compliant)

### Applications

- Short circuit protected switching
- Under-voltage shut-down circuits
- Switch-mode power supplies
- Motor controls
- Power MOSFET switching
- Switching capacitive loads
- Shoot-thru protection
- Latching drivers

### Pinouts

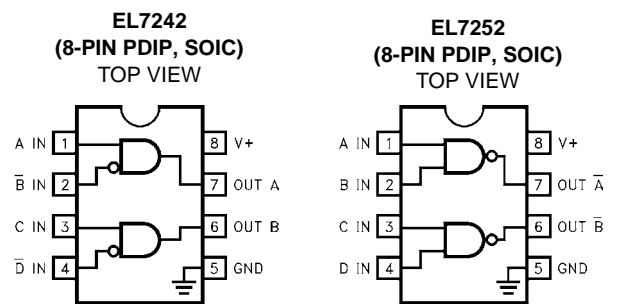

Manufactured under U.S. Patent Nos. 5,334,883, #5,341,047

## EL7242, EL7252

### Absolute Maximum Ratings (T<sub>A</sub> = 25°C)

Supply (V+ to Gnd) ..... 16.5V  
 Input Pins ..... -0.3V to +0.3V above V+  
 Combined Peak Output Current ..... .4A  
 Storage Temperature Range ..... -65°C to +150°C

Ambient Operating Temperature ..... -40°C to +85°C  
 Operating Junction Temperature ..... 125°C  
 Power Dissipation  
     SOIC ..... .570mW  
     PDIP\* ..... 1050mW

\*Pb-free PDIPs can be used for through hole wave solder processing only. They are not intended for use in Reflow solder processing applications.

*CAUTION: Stresses above those listed in "Absolute Maximum Ratings" may cause permanent damage to the device. This is a stress only rating and operation of the device at these or any other conditions above those indicated in the operational sections of this specification is not implied.*

*IMPORTANT NOTE: All parameters having Min/Max specifications are guaranteed. Typical values are for information purposes only. Unless otherwise noted, all tests are at the specified temperature and are pulsed tests, therefore: T<sub>J</sub> = T<sub>C</sub> = T<sub>A</sub>*

### DC Electrical Specifications T<sub>A</sub> = 25°C, V = 15V unless otherwise specified

PARAMETER	DESCRIPTION	TEST CONDITIONS	MIN	TYP	MAX	UNITS
<b>INPUT</b>						
V <sub>IH</sub>	Logic "1" Input Voltage		2.4			V
I <sub>IH</sub>	Logic "1" Input Current	@V+		0.1	10	μA
V <sub>IL</sub>	Logic "0" Input Voltage				0.8	V
I <sub>IL</sub>	Logic "0" Input Current	@0V		0.1	10	μA
V <sub>HVS</sub>	Input Hysteresis			0.3		V
<b>OUTPUT</b>						
R <sub>OH</sub>	Pull-Up Resistance	I <sub>OUT</sub> = -100mA		3	6	Ω
R <sub>OL</sub>	Pull-Down Resistance	I <sub>OUT</sub> = +100mA		4	6	Ω
I <sub>PK</sub>	Peak Output Current	Source Sink		2 2		A
I <sub>DC</sub>	Continuous Output Current	Source/Sink	100			mA
<b>POWER SUPPLY</b>						
I <sub>S</sub>	Power Supply Current	Inputs High		1	2.5	mA
V <sub>S</sub>	Operating Voltage		4.5		16	V

### AC Electrical Specifications T<sub>A</sub> = 25°C, V = 15V unless otherwise specified

PARAMETER	DESCRIPTION	TEST CONDITIONS	MIN	TYP	MAX	UNITS
<b>SWITCHING CHARACTERISTICS</b>						
t <sub>R</sub>	Rise Time	C <sub>L</sub> = 500pF C <sub>L</sub> = 1000pF			10 20	ns
t <sub>F</sub>	Fall Time	C <sub>L</sub> = 500pF C <sub>L</sub> = 1000pF			10 20	ns
t <sub>D-ON</sub>	Turn-On Delay Time			20	25	ns
t <sub>D-OFF</sub>	Turn-Off Delay Time			20	25	ns

**Timing Table**

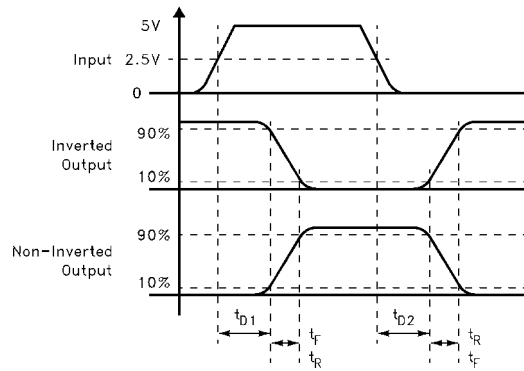

**Standard Test Configuration**

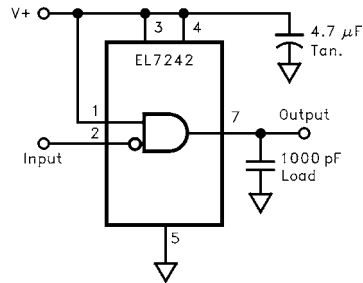

**Simplified Schematic**

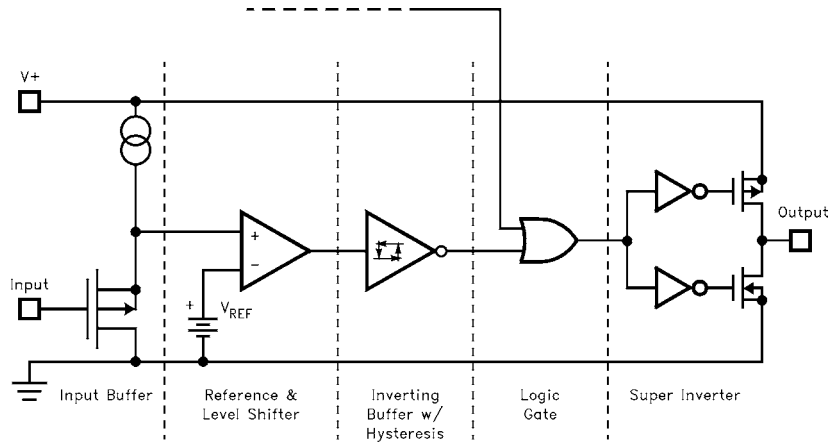

Typical Performance Curves

Max Power/Derating Curves

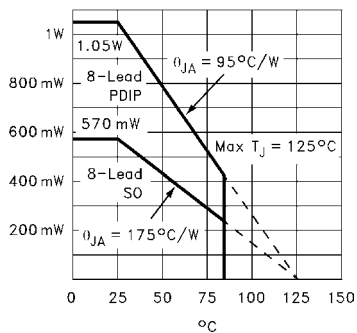

Switch Threshold vs Supply Voltage

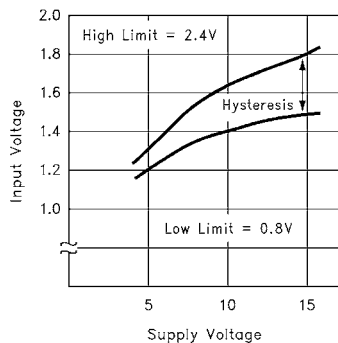

Input Current vs Voltage

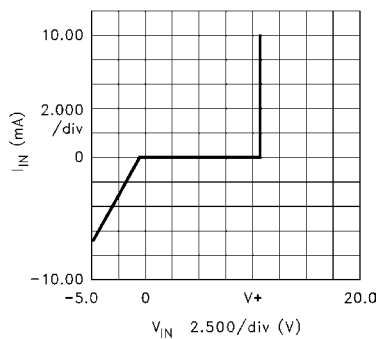

Peak Drive vs Supply Voltage

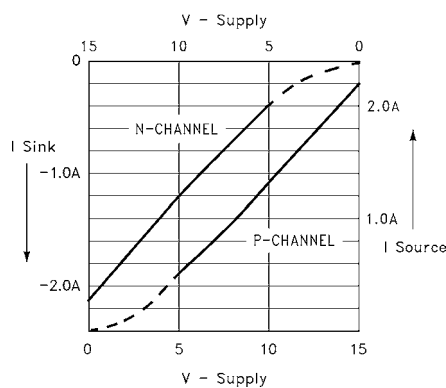

Quiescent Supply Current

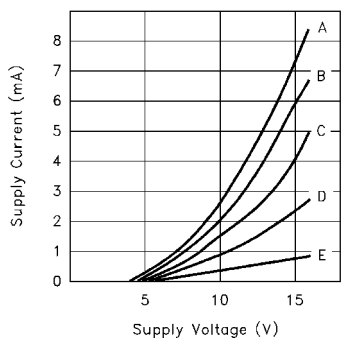

CASE:

A	ALL INPUTS GND
B	3 INPUTS GND
C	2 INPUTS GND
D	1 INPUT GND
E	ALL INPUTS V+

"ON" Resistance vs Supply Voltage

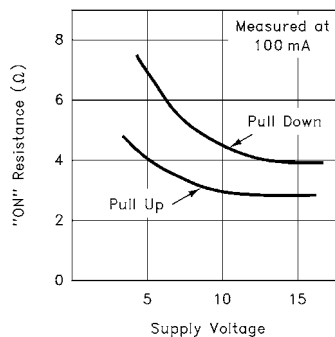

Typical Performance Curves (Continued)

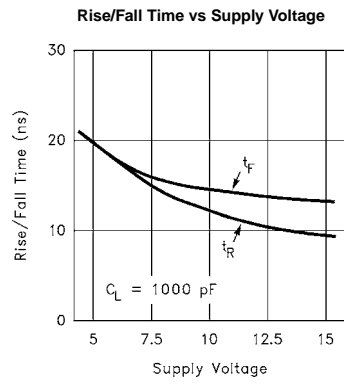
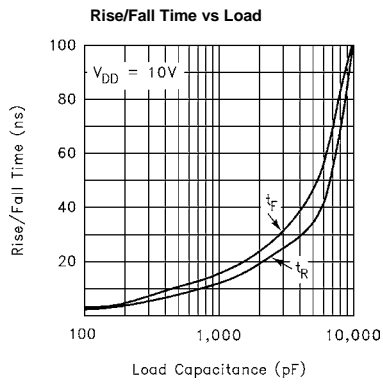
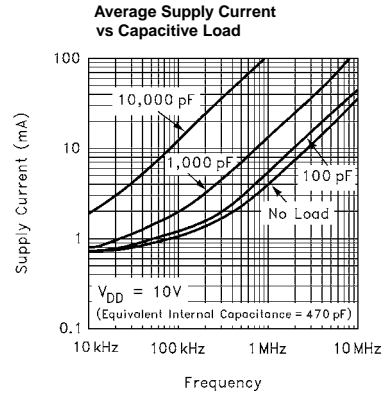
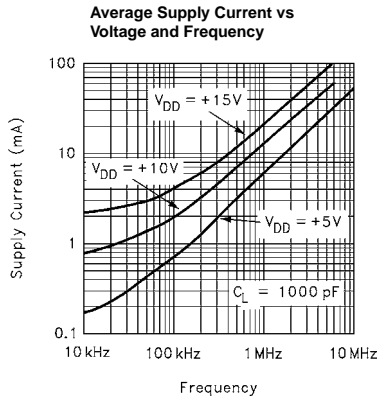

Typical Performance Curves (Continued)

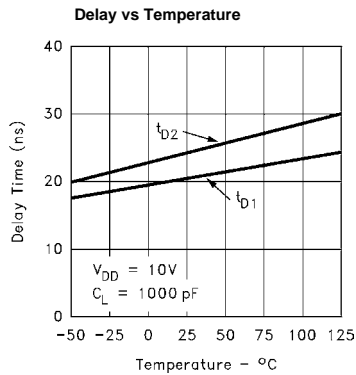
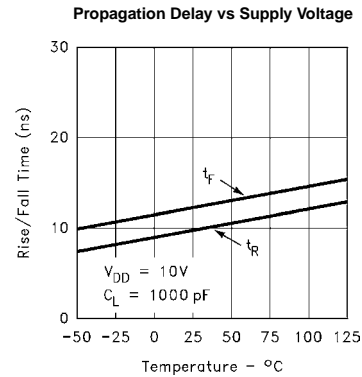
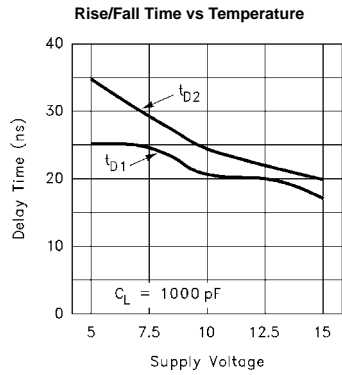

All Intersil U.S. products are manufactured, assembled and tested utilizing ISO9000 quality systems. Intersil Corporation's quality certifications can be viewed at [www.intersil.com/design/quality](http://www.intersil.com/design/quality)

*Intersil products are sold by description only. Intersil Corporation reserves the right to make changes in circuit design, software and/or specifications at any time without notice. Accordingly, the reader is cautioned to verify that data sheets are current before placing orders. Information furnished by Intersil is believed to be accurate and reliable. However, no responsibility is assumed by Intersil or its subsidiaries for its use; nor for any infringements of patents or other rights of third parties which may result from its use. No license is granted by implication or otherwise under any patent or patent rights of Intersil or its subsidiaries.*

For information regarding Intersil Corporation and its products, see [www.intersil.com](http://www.intersil.com)