

General Description

The MIC33030 is a high-efficiency, 8MHz, 400mA synchronous buck regulator with an internal inductor and HyperLight Load™ mode. HyperLight Load™ provides very-high efficiency at light loads and ultra-fast transient response that is perfectly suited for supplying processor core voltages. An additional benefit of this proprietary architecture is the very-low output ripple voltage throughout the entire load range with the use of small output capacitors. The tiny 2.5mm x 2.0mm MLF® package saves precious board space and requires only two external capacitors.

The MIC33030 is designed for use with tiny output capacitors as small as 2.2µF. This gives the MIC33030 the ease of use of an LDO with the efficiency of a HyperLight Load™ DC converter.

The MIC33030 achieves efficiency in HyperLight Load™ mode as high as 78% at 1mA, with a very-low quiescent current of 21µA. At higher loads, the MIC33030 provides a constant switching frequency up to 8MHz.

The MIC33030 is available in a 10-pin 2.5mm x 2.0mm MLF® package with an operating junction temperature range of -40°C to +125°C.

Datasheets and support documentation can be found on Micrel's web site at: www.micrel.com.

Features

- Internal Inductor
 - Simplifies design to two external capacitors
- Input voltage: 2.7V to 5.5V
- Output voltage accuracy of ±2.5% over temperature
- 400mA output current
- Efficiency up to 78% at 1mA
- 21µA typical quiescent current
- Up to 8MHz PWM operation in continuous mode
- Ultra-fast transient response
- Low-voltage output ripple
 - 30mVpp ripple in HyperLight Load™ mode
 - 7mV output voltage ripple in full PWM mode
- Fully-integrated MOSFET switches
- 0.01µA shutdown current
- Thermal shutdown and current-limit protection
- Fixed and adjustable output voltage options available (0.7V to 3.6V)
- 2.5mm x 2.0mm 10-Lead MLF®
- -40°C to +125°C junction temperature range

Applications

- Mobile handsets
- Portable media/MP3 players
- Portable navigation devices (GPS)
- WiFi/WiMax/WiBro modules
- Digital Cameras
- Wireless LAN cards
- USB-powered devices
- Portable applications

Typical Application

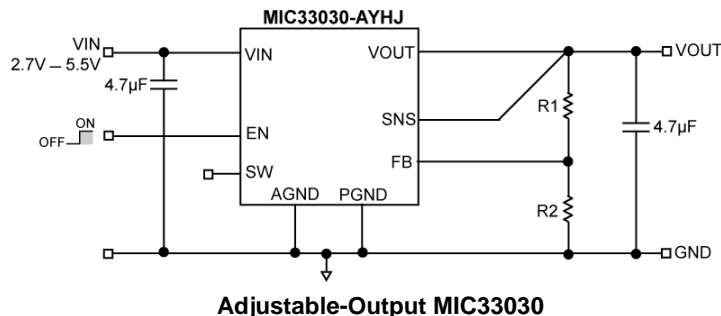
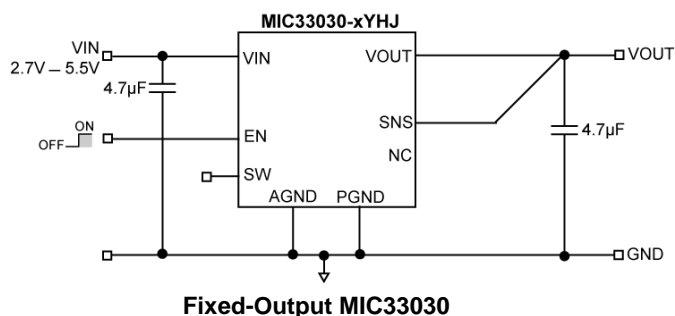

HyperLight Load is a trademark of Micrel, Inc.
MLF and MicroLeadFrame are registered trademark Amkor Technology Inc.

Micrel Inc. • 2180 Fortune Drive • San Jose, CA 95131 • USA • tel +1 (408) 944-0800 • fax + 1 (408) 474-1000 • <http://www.micrel.com>

Ordering Information

Part Number	Marking Code	Nominal Output Voltage	Junction Temperature Range	Package	Lead Finish
MIC33030-AYHJ	3GFA	ADJ	-40°C to +125°C	10-pin 2.5mm x 2.0mm MLF [®]	Pb-Free
MIC33030-JYHJ	3GFJ	2.5V	-40°C to +125°C	10-pin 2.5mm x 2.0mm MLF [®]	Pb-Free
MIC33030-GYHJ	3GFG	1.8V	-40°C to +125°C	10-pin 2.5mm x 2.0mm MLF [®]	Pb-Free
MIC33030-4YHJ	3GF4	1.2V	-40°C to +125°C	10-pin 2.5mm x 2.0mm MLF [®]	Pb-Free

Notes:

1. Other options available. Contact Micrel for details.
2. Thin MLF[®] is GREEN RoHS compliant package. Lead finish is NiPdAu. Mold compound is Halogen Free.

Pin Configuration

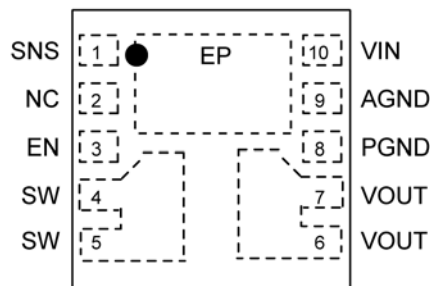

2.5mm x 2.0mm MLF[®] (HJ)
Fixed (Top View)

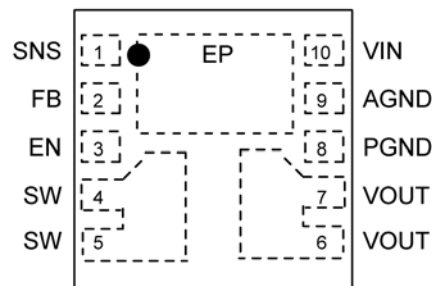

2.5mm x 2.0mm MLF[®] (HJ)
Adjustable (Top View)

Pin Description

Fixed Option	ADJ Option	Pin Name	Pin Function
1	1	SNS	Sense: Connect to V_{OUT} as close to output capacitor as possible to sense output voltage.
2	-	NC	Not internally connected.
-	2	FB	Feedback: Connect resistor divider at this node to set output voltage. Resistors should be selected based on a nominal $V_{FB} = 0.62V$.
3	3	EN	Enable: Logic high enables operation of the regulator. Logic low will shut down the device. Do not leave floating.
4, 5	4, 5	SW	Switch: Internal power MOSFET output switches.
6, 7	6, 7	VOUT	Output Voltage: The output of the regulator. Connect to SNS pin. For adjustable option, connect to feedback resistor network.
8	8	PGND	Power Ground.
9	9	AGND	Analog Ground.
10	10	VIN	Input Voltage: Connect a capacitor to ground to decouple the noise.
EP	EP	HS PAD	Connect to PGND or AGND.

Absolute Maximum Ratings⁽¹⁾

Supply Voltage (V_{IN})	-0.3V to 6V
Sense (V_{SNS})	-0.3V to 6V
Output Switch Voltage	-0.3V to 6V
Enable Input Voltage (V_{EN})	-0.3V to V_{IN}
Storage Temperature Range	-65°C to +150°C
ESD Rating ⁽³⁾	ESD Sensitive

Operating Ratings⁽²⁾

Supply Voltage (V_{IN})	2.7V to 5.5V
Enable Input Voltage (V_{EN})	0V to V_{IN}
Output Voltage Range (V_{SNS})	0.7V to 3.6V
Junction Temperature Range (T_J)	-40°C ≤ T_J ≤ +125°C
Thermal Resistance	
2.5mm x 2.0mm MLF [®] -10 (θ_{JA})	76°C/W
2.5mm x 2.0mm MLF [®] -10 (θ_{JC})	45°C/W

Electrical Characteristics⁽⁴⁾

$T_A = 25^\circ\text{C}$; $V_{IN} = V_{EN} = 3.6\text{V}$; $C_{OUT} = 4.7\mu\text{F}$ unless otherwise specified. **Bold** values indicate $-40^\circ\text{C} \leq T_J \leq +125^\circ\text{C}$, unless noted.

Parameter	Condition	Min.	Typ.	Max.	Units
Supply Voltage Range		2.7		5.5	V
Under-Voltage Lockout Threshold	(turn-on)	2.45	2.55	2.65	V
Under-Voltage Lockout Hysteresis			100		mV
Quiescent Current	$I_{OUT} = 0\text{mA}$, $SNS > 1.2 * V_{OUT}$ Nominal		21	35	μA
Shutdown Current	$V_{EN} = 0\text{V}$; $V_{IN} = 5.5\text{V}$		0.01	4	μA
Output Voltage Accuracy	$V_{IN} = 3.6\text{V}$; $I_{LOAD} = 20\text{mA}$	-2.5		+2.5	%
Feedback Voltage	Adjustable Option Only		0.62		V
Current Limit	$SNS = 0.9 * V_{OUTNOM}$	0.41	0.7	1	A
Output Voltage Line Regulation	$V_{IN} = 3.0\text{V}$ to 5.5V , $V_{OUT} = 1.2\text{V}$, $I_{LOAD} = 20\text{mA}$,		0.5		%/V
Output Voltage Load Regulation	$20\text{mA} < I_{LOAD} < 400\text{mA}$, $V_{OUT} = 1.2\text{V}$, $V_{IN} = 3.6\text{V}$		0.7		%
PWM Switch ON-Resistance	$I_{SW} = 100\text{mA}$ PMOS		0.65		Ω
	$I_{SW} = -100\text{mA}$ NMOS		0.8		Ω
Maximum Frequency	$I_{OUT} = 120\text{mA}$		8		MHz
Soft Start Time	$V_{OUT} = 90\%$		100		μs
Enable Threshold		0.5	0.9	1.2	V
Enable Hysteresis			35		mV
Enable Input Current			0.1	2	μA
Over-Temperature Shutdown			160		$^\circ\text{C}$
Over-Temperature Shutdown Hysteresis			20		$^\circ\text{C}$

Notes:

1. Exceeding the absolute maximum rating may damage the device.
2. The device is not guaranteed to function outside its operating rating.
3. Devices are ESD sensitive. Handling precautions recommended. Human body model, 1.5k Ω in series with 100pF.
4. Specification for packaged product only.

Typical Characteristics

Efficiency vs. Load
(V_{OUT} = 2.5V)

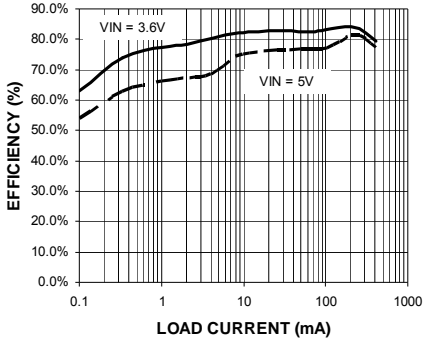

Efficiency vs. Load
(V_{OUT} = 1.8V)

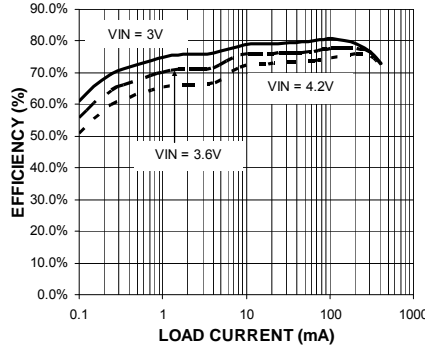

Efficiency vs. Load
(V_{OUT} = 1.5V)

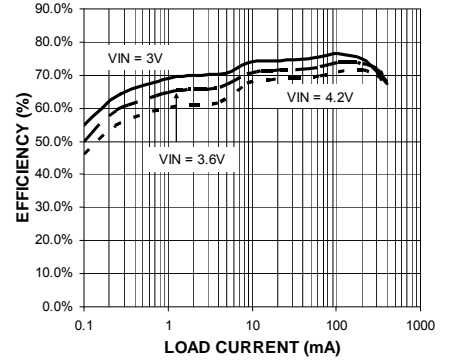

Efficiency vs. Load
(V_{OUT} = 1.2V)

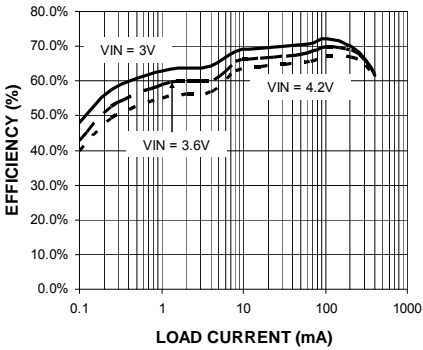

Efficiency vs. Load
(V_{OUT} = 1V)

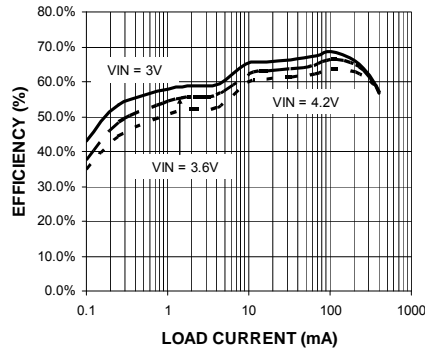

Quiescent Current vs. Input Voltage
(Not Switching)

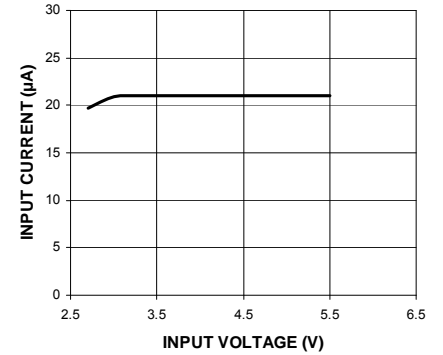

Quiescent Current vs. Temperature
(Not Switching)

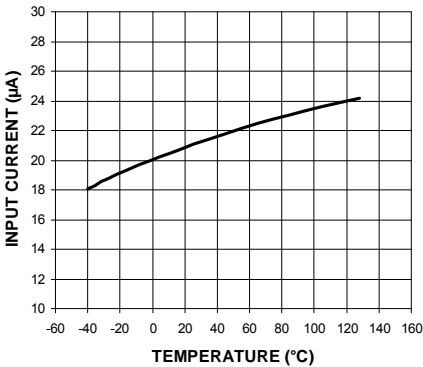

Output Voltage vs. Input Voltage

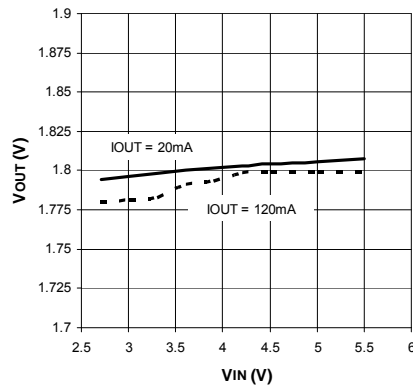

Output Voltage vs. Output Current

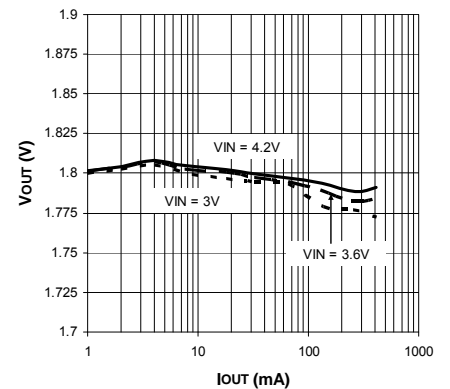

Typical Characteristics (Continued)

Output Voltage vs. Temperature

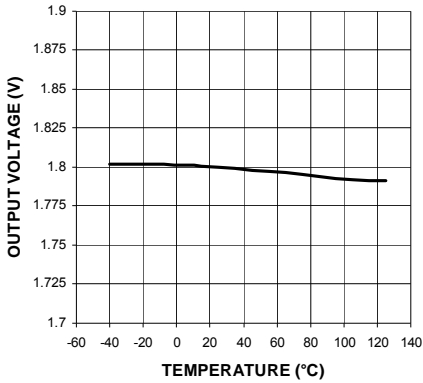

Switching Frequency vs. Temperature

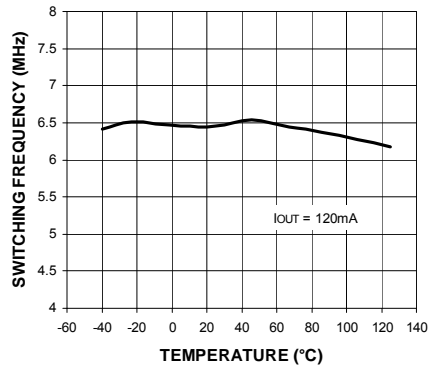

Switching Frequency vs. Load Current

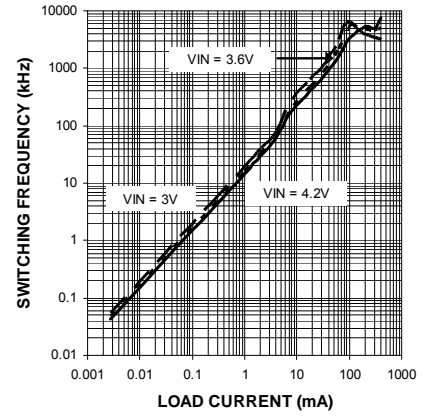

Enable (ON) Voltage vs. Input Voltage

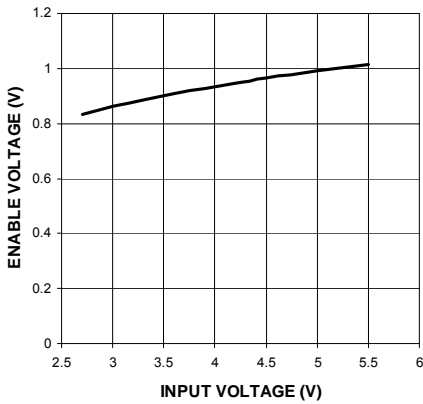

Enable Voltage vs. Temperature

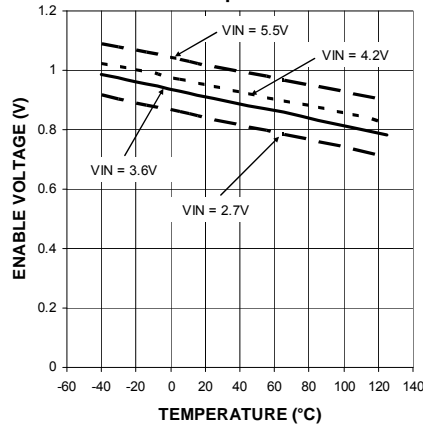

Current Limit vs. Input Voltage

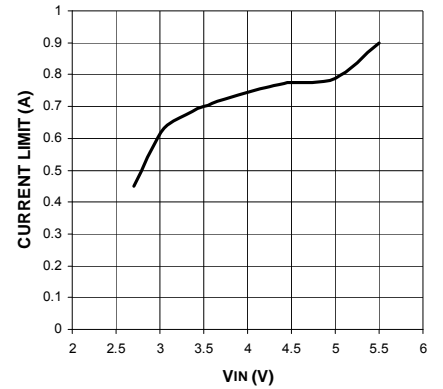

Functional Characteristics

Switching Waveform – Discontinuous Mode
I_{OUT} = 1mA

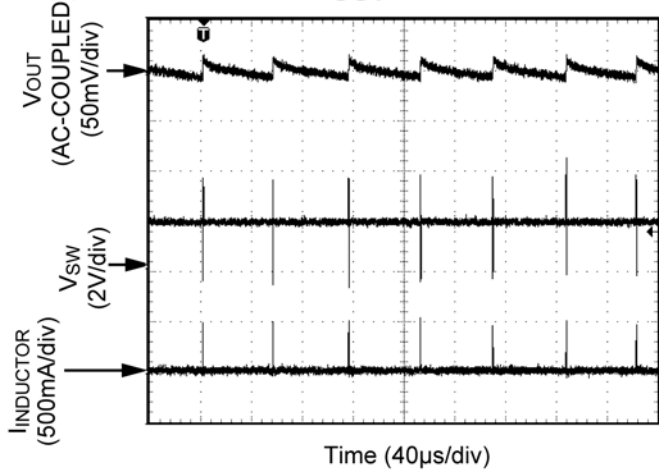

Switching Waveform – Discontinuous Mode
I_{OUT} = 10mA

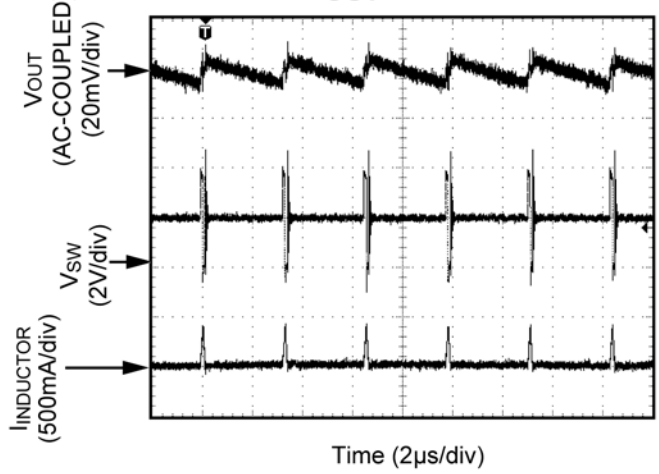

Switching Waveform – Discontinuous Mode
I_{OUT} = 50mA

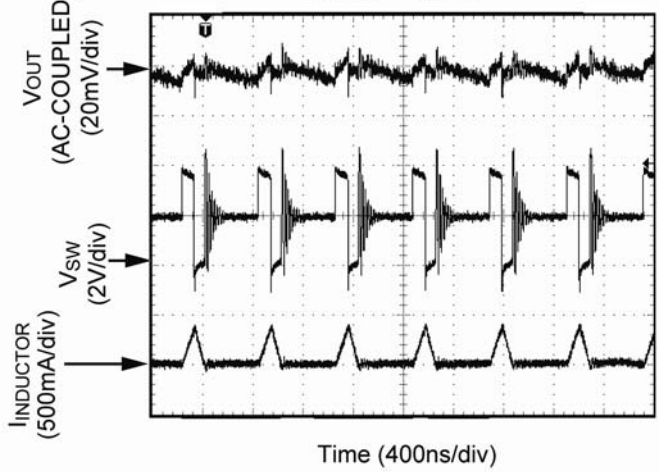

Switching Waveform – Continuous Mode
I_{OUT} = 120mA

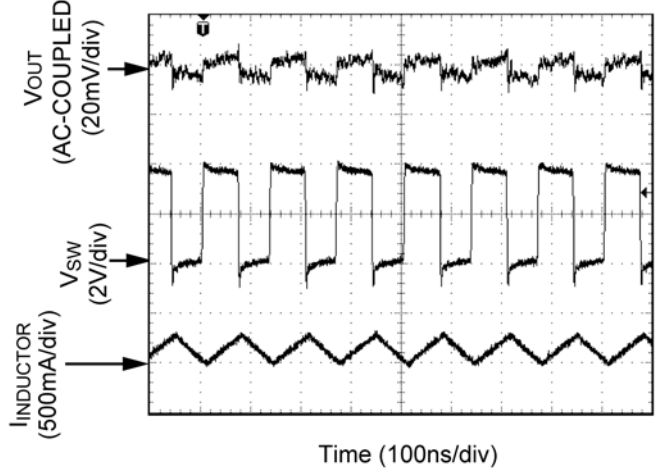

Switching Waveform – Continuous Mode
I_{OUT} = 300mA

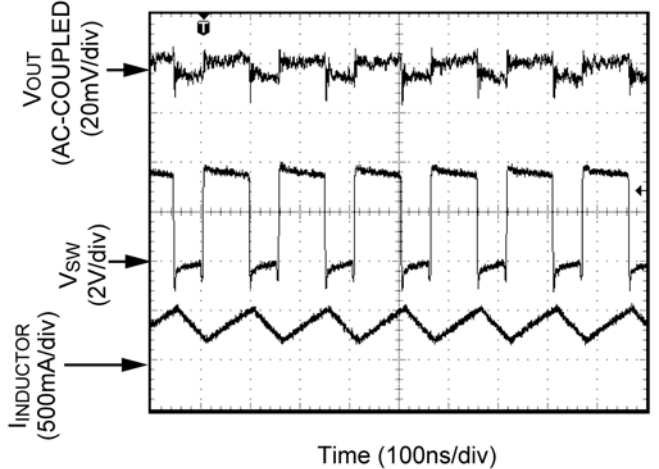

Switching Waveform – Continuous Mode
I_{OUT} = 400mA

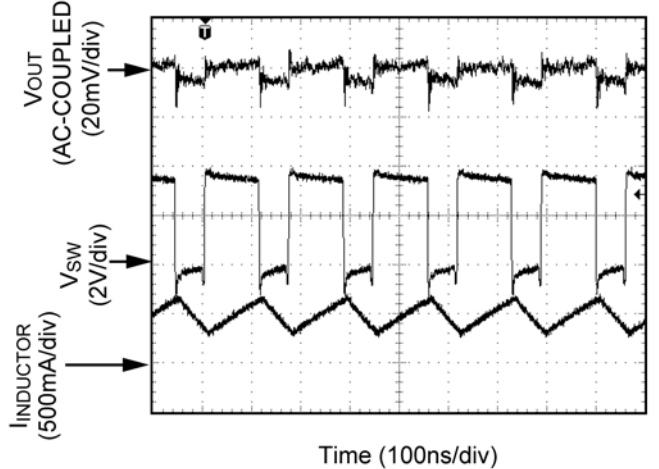

Functional Characteristics (Continued)

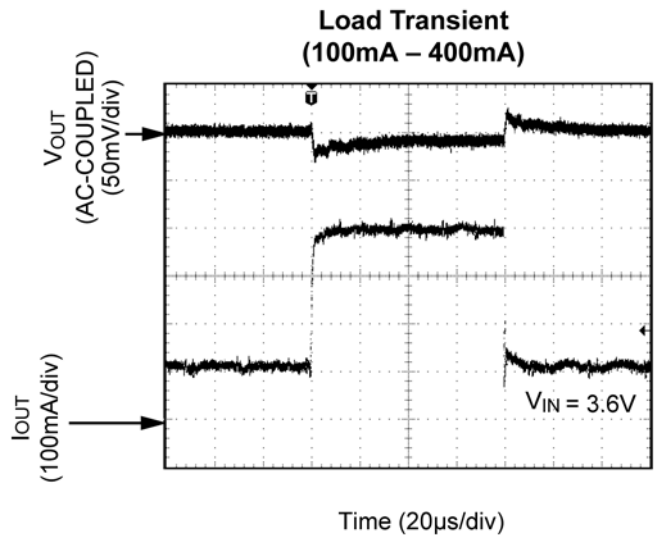
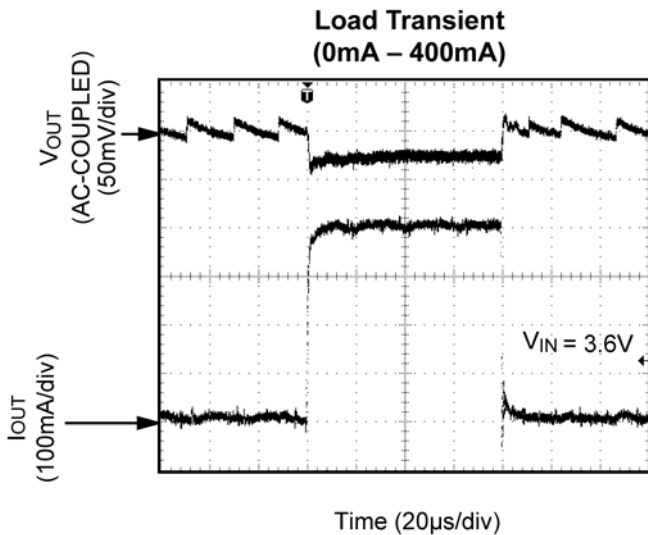
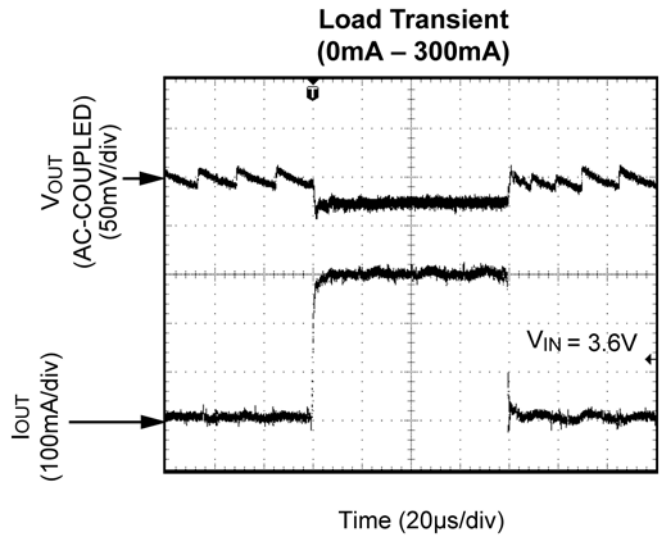
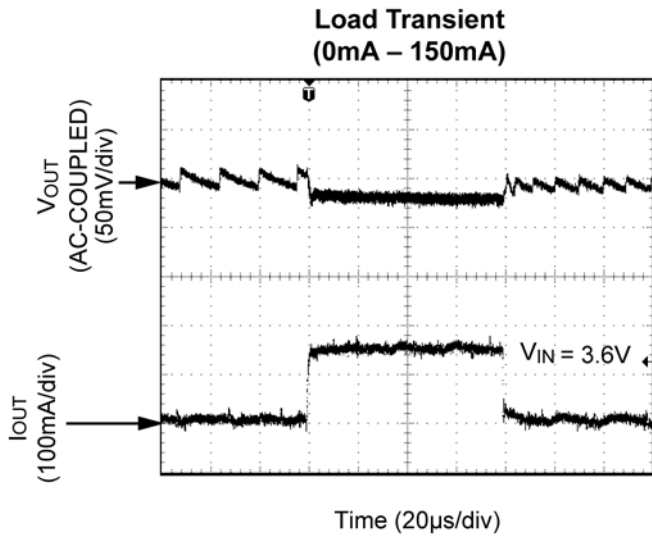
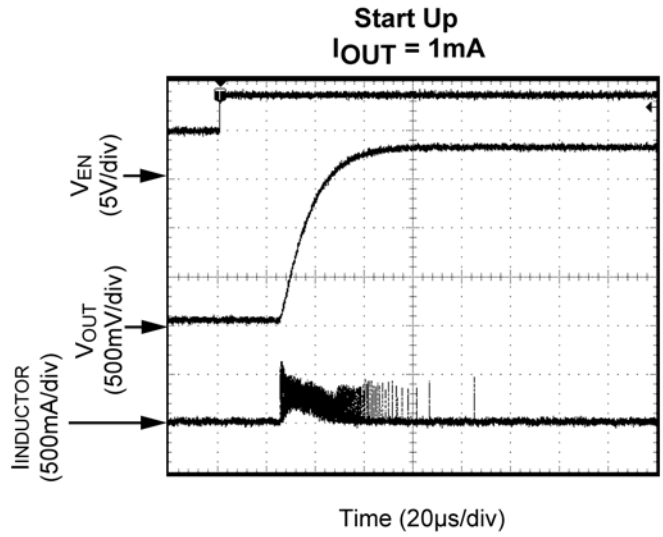
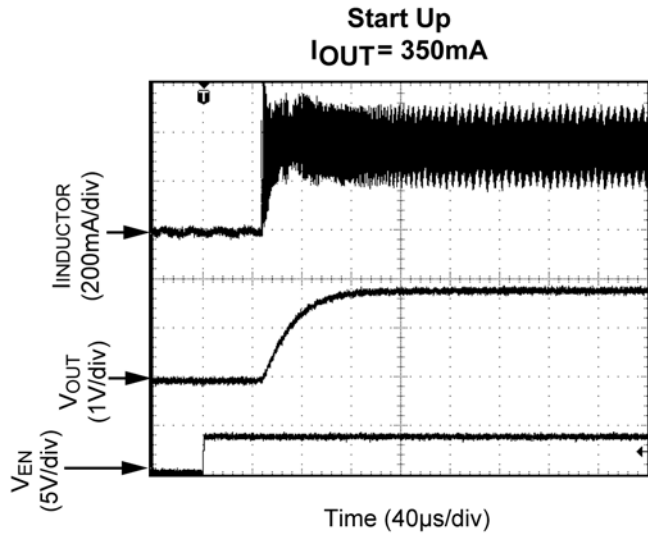

Functional Characteristics (Continued)

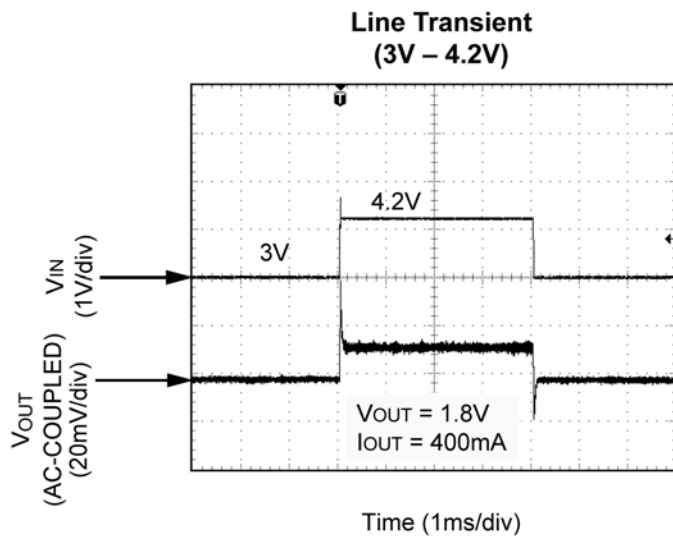

Functional Diagram

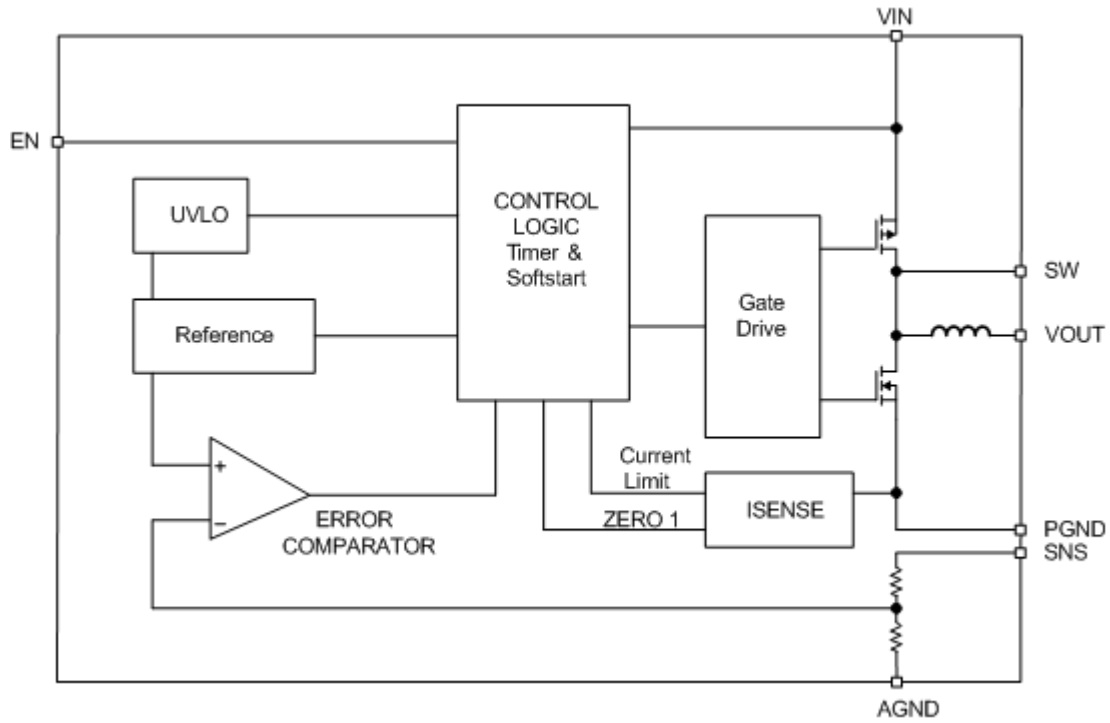

Simplified MIC33030 Fixed Functional Block Diagram

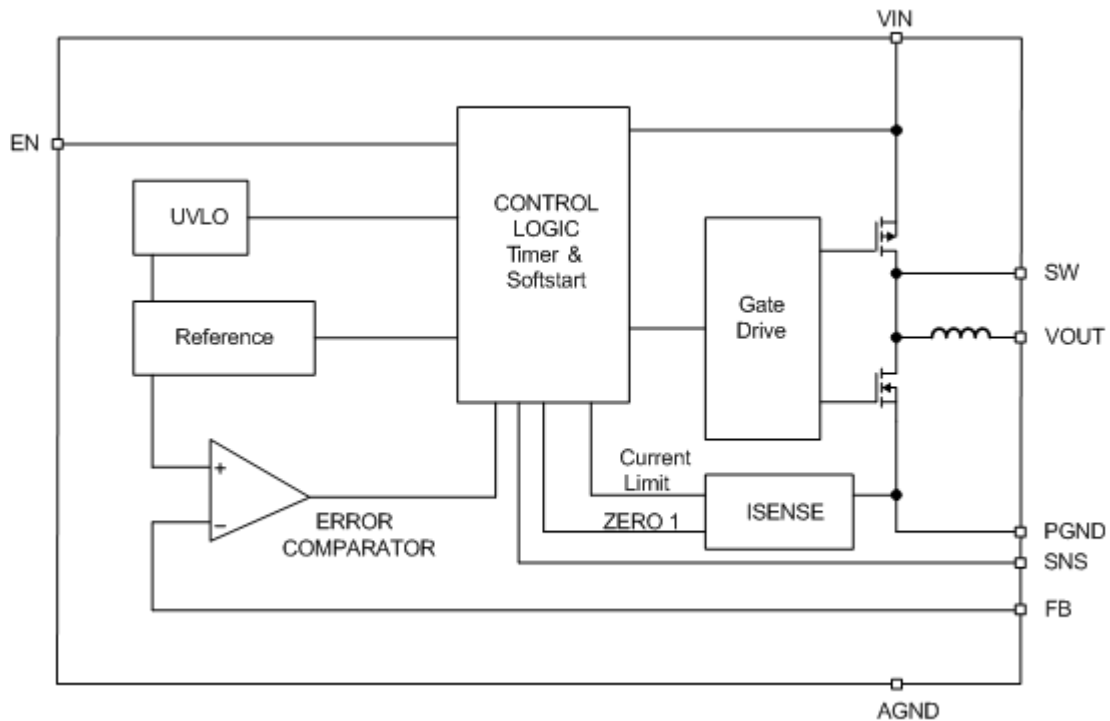

Simplified MIC33030 Adjustable Functional Block Diagram

Functional Description

VIN

The input supply (VIN) provides power to the internal MOSFETs for the switch mode regulator along with the internal control circuitry. The VIN operating range is 2.7V to 5.5V so an input capacitor, with a minimum voltage rating of 6.3V, is recommended. Due to the high switching speed, a minimum 2.2µF bypass capacitor placed close to VIN and the power ground (PGND) pin is required. Refer to the layout recommendations for details.

EN

A logic high signal on the enable pin activates the output voltage of the device. A logic low signal on the enable pin deactivates the output and reduces supply current to 0.01µA. The MIC33030 features built-in soft-start circuitry that reduces in-rush current and prevents the output voltage from overshooting at start up. Do not leave the enable pin floating.

SW

The switch (SW) connects directly to one end of the internal inductor and provides the current path during switching cycles. The other end of the inductor is connected to the load, SNS pin and output capacitor. As the MIC33030 has an internal inductor, this pin is not routed in most applications.

VOUT

The output pin (VOUT) is the output voltage pin following the internal inductor. Connect a minimum of 2.2µF output filter capacitor to this pin.

SNS

The sense (SNS) pin is connected to the output of the device to provide feedback to the control circuitry. The SNS connection should be placed close to the output capacitor. Refer to the layout recommendations for more details.

AGND

The analog ground (AGND) is the ground path for the biasing and control circuitry. The current loop for the signal ground should be separate from the power ground (PGND) loop. Refer to the layout recommendations for more details.

FB (Adjustable Output Only)

The feedback pin (FB) allows the regulated output voltage to be set by applying an external resistor network. The internal reference voltage is 0.62V and the recommended value of R2 is 200kΩ. The output voltage is calculated from the equation below:

$$V_{OUT} = 0.62V \left(\frac{R1}{200k\Omega} + 1 \right)$$

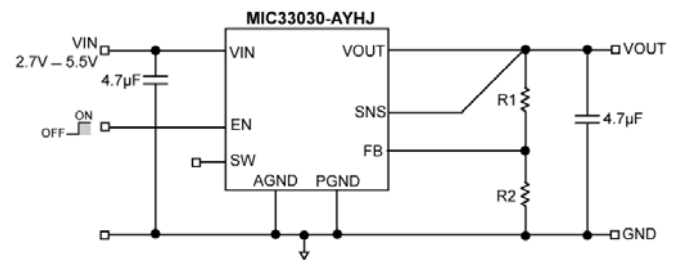

Figure 1. MIC33030-AYHJ Schematic

PGND

The power ground pin is the ground path for the high current in PWM mode. The current loop for the power ground should be as small as possible and separate from the analog ground (AGND) loop as applicable. Refer to the layout recommendations for more details.

Application Information

The MIC33030 is a high-performance DC/DC step down regulator offering a small solution size. Supporting an output current up to 400mA inside a tiny 2.5mm x 2.0mm MLF® package and requiring only two external components, the MIC33030 meets today's miniature portable electronic device needs. Using the HyperLight Load™ switching scheme, the MIC33030 is able to maintain high efficiency throughout the entire load range while providing ultra-fast load transient response. The following sections provide additional device application information.

Input Capacitor

A 2.2µF ceramic capacitor or greater should be placed close to the VIN pin and PGND pin for bypassing. A TDK C1608X5R0J475K, size 0603, 4.7µF ceramic capacitor is recommended based upon performance, size and cost. A X5R or X7R temperature rating is recommended for the input capacitor. Y5V temperature rating capacitors, aside from losing most of their capacitance over temperature, can also become resistive at high frequencies. This reduces their ability to filter out high-frequency noise.

Output Capacitor

The MIC33030 was designed for use with a 2.2µF or greater ceramic output capacitor. Increasing the output capacitance will lower output ripple and improve load transient response but could increase solution size or cost. A low equivalent series resistance (ESR) ceramic output capacitor such as the TDK C1608X5R0J475K, size 0603, 4.7µF ceramic capacitor is recommended based upon performance, size and cost. Both the X7R or X5R temperature rating capacitors are recommended. The Y5V and Z5U temperature rating capacitors are not recommended due to their wide variation in capacitance over temperature and increased resistance at high frequencies.

Compensation

The MIC33030 is designed to be stable with a minimum of 2.2µF ceramic (X5R) output capacitor.

Duty Cycle

The typical maximum duty cycle of the MIC33030 is 90%.

Efficiency Considerations

Efficiency is defined as the amount of useful output power, divided by the amount of power supplied.

$$\text{Efficiency \%} = \left(\frac{V_{OUT} \times I_{OUT}}{V_{IN} \times I_{IN}} \right) \times 100$$

Maintaining high efficiency serves two purposes. It reduces power dissipation in the power supply, reducing the need for heat sinks and thermal design considerations and it reduces consumption of current for battery powered applications. Reduced current draw from a battery increases the devices operating time which is critical in hand held devices.

There are two types of losses in switching converters; DC losses and switching losses. DC losses are simply the power dissipation of I^2R . Power is dissipated in the high-side switch during the on cycle. Power loss is equal to the high-side MOSFET $R_{DS(ON)}$ multiplied by the Switch Current squared. During the off cycle, the low-side N-channel MOSFET conducts, also dissipating power. Device operating current also reduces efficiency. The product of the quiescent (operating) current and the supply voltage represents another DC loss. The current required driving the gates on and off at a constant 8MHz frequency and the switching transitions make up the switching losses.

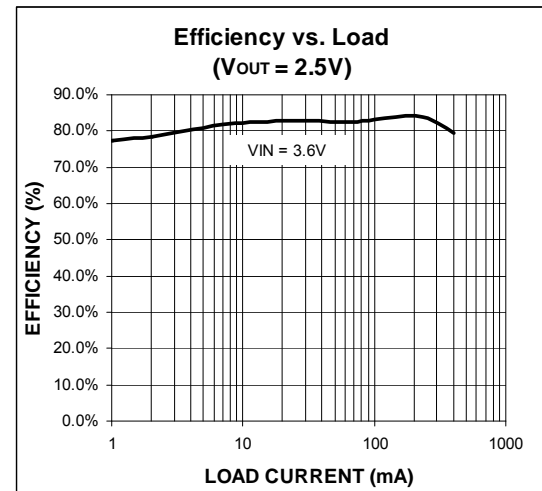

Figure 2. Efficiency under Load

Figure 2 shows an efficiency curve. From no load to 100mA, efficiency losses are dominated by quiescent current losses, gate drive and transition losses. By using the HyperLight Load™ mode, the MIC33030 is able to maintain high efficiency at low output currents.

Over 100mA, efficiency loss is dominated by MOSFET $R_{DS(ON)}$ and inductor losses. Higher input supply voltages will increase the Gate-to-Source threshold on the internal MOSFETs, thereby reducing the internal $R_{DS(ON)}$. This improves efficiency by reducing DC losses in the device. All but the inductor losses are inherent to the device. In which case, inductor selection becomes increasingly critical in efficiency calculations. As the inductors are reduced in size, the DC resistance (DCR) can become quite significant.

The DCR losses can be calculated as follows:

$$P_{DCR} = I_{OUT}^2 \times DCR$$

From that, the loss in efficiency due to inductor resistance can be calculated as follows:

$$Efficiency\ Loss = \left[1 - \left(\frac{V_{OUT} \times I_{OUT}}{V_{OUT} \times I_{OUT} + P_{DCR}} \right) \right] \times 100$$

Efficiency loss due to DCR is minimal at light loads and gains significance as the load is increased. Inductor selection becomes a trade-off between efficiency and size in this case.

The effect of MOSFET voltage drops and DCR losses in conjunction with the maximum duty cycle combine to limit maximum output voltage for a given input voltage. The following graph shows this relationship based on the typical resistive losses in the MIC33030:

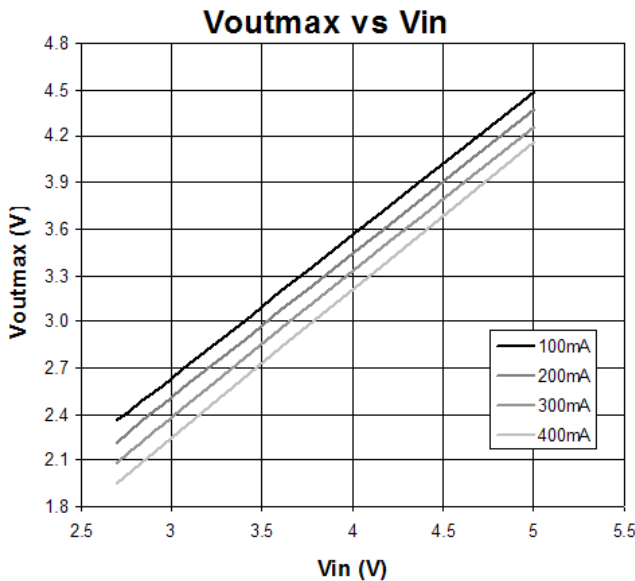

HyperLight Load™ Mode

MIC33030 uses a minimum on and off time proprietary control loop (patented by Micrel). When the output voltage falls below the regulation threshold, the error comparator begins a switching cycle that turns the PMOS on and keeps it on for the duration of the minimum-on-time. This increases the output voltage. If the output voltage is over the regulation threshold, then the error comparator turns the PMOS off for a minimum-off-time until the output drops below the threshold. The NMOS acts as an ideal rectifier that conducts when the PMOS is off. Using a NMOS switch instead of a diode allows for lower voltage drop across the switching device when it is on. The asynchronous switching combination between the PMOS and the NMOS allows the control loop to work in discontinuous mode for light load operations. In discontinuous mode, the MIC33030 works in pulse frequency modulation (PFM) to regulate the output. As the output current increases, the off-time decreases, thus provides more energy to the output. This switching scheme improves the efficiency of MIC33030 during light load currents by only switching when it is needed. As the load current increases, the MIC33030 goes into continuous conduction mode (CCM) and switches at a frequency centered at 8MHz. The equation to calculate the load when the MIC33030 goes into continuous conduction mode may be approximated by the following formula:

$$I_{LOAD} > \left(\frac{(V_{IN} - V_{OUT}) \times D}{2L \times f} \right)$$

As shown in the above equation, the load at which MIC33030 transitions from HyperLight Load™ mode to PWM mode is a function of the input voltage (V_{IN}), output voltage (V_{OUT}), duty cycle (D), inductance (L) and frequency (f). Since the inductance of MIC33030 is 0.36µH, the device will enter HyperLight Load™ mode or PWM mode at approximately 150mA.

Power Dissipation Considerations

As with all power devices, the ultimate current rating of the output is limited by the thermal properties of the package and the PCB it is mounted on. There is a simple, ohms law type relationship between thermal resistance, power dissipation and temperature which are analogous to an electrical circuit:

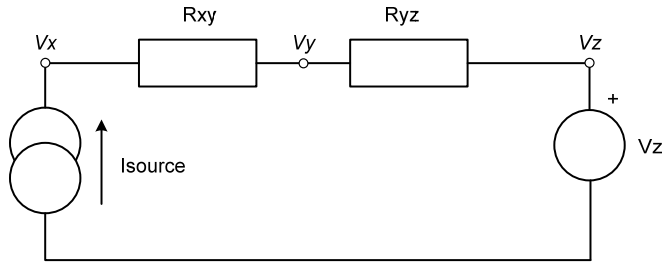

From this simple circuit we can calculate Vx if we know Isource, Vz and the resistor values, Rxy and Ryz using the equation:

$$V_x = I_{source} \cdot (R_{xy} + R_{yz}) + V_z$$

Thermal circuits can be considered using these same rules and can be drawn similarly replacing current sources with Power dissipation (in Watts), Resistance with Thermal Resistance (in °C/W) and Voltage sources with temperature (in °C):

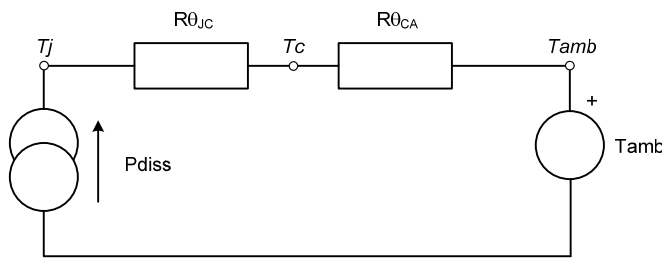

Now replacing the variables in the equation for Vx, we can find the junction temperature (Tj) from power dissipation, ambient temperature and the known thermal resistance of the PCB (RθCA) and the package (RθJC):

$$T_J = P_{DISS} \cdot (R_{\theta_{JC}} + R_{\theta_{CA}}) + T_{AMB}$$

As can be seen in the diagram, total thermal resistance RθJA = RθJC + RθCA. Hence this can also be written:

$$T_J = P_{DISS} \cdot (R_{\theta_{JA}}) + T_{AMB}$$

Since effectively all of the power loss in the converter is dissipated within the MIC33030 package, PDISS can be calculated thus:

$$P_{DISS} = P_{OUT} \cdot \left(\frac{1}{\eta} - 1\right)$$

Where η = Efficiency taken from efficiency curves

RθJC and RθJA are found in the operating ratings section of the datasheet.

Example:

A MIC33030 is intended to drive a 300mA load at 1.8V and is placed on a printed circuit board which has a ground plane area of at least 25mm square. The Voltage source is a Li-ion battery with a lower operating threshold of 3V and the ambient temperature of the assembly can be up to 50°C.

Summary of variables:

I_{OUT} = 0.3A

V_{OUT} = 1.8V

V_{IN} = 3V to 4.2V

T_{AMB} = 50°C

R_{θJA} = 76°C/W from Datasheet

η @ 300mA = 75% (worst case with V_{IN}=4.2V from the Typical Characteristics Efficiency vs. Load graphs)

$$P_{DISS} = 1.8 \cdot 0.3 \cdot \left(\frac{1}{0.75} - 1\right) = 0.18W$$

The worst case switch and inductor resistance will increase at higher temperatures, so a margin of 20% can be added to account for this:

$$P_{DISS} = 0.18 \times 1.2 = .216W$$

Therefore:

T_J = 0.216W. (76°C/W) + 50°C

T_J = 66°C

This is well below the maximum 125°C.

MIC33030 Typical Application Circuit (Fixed)

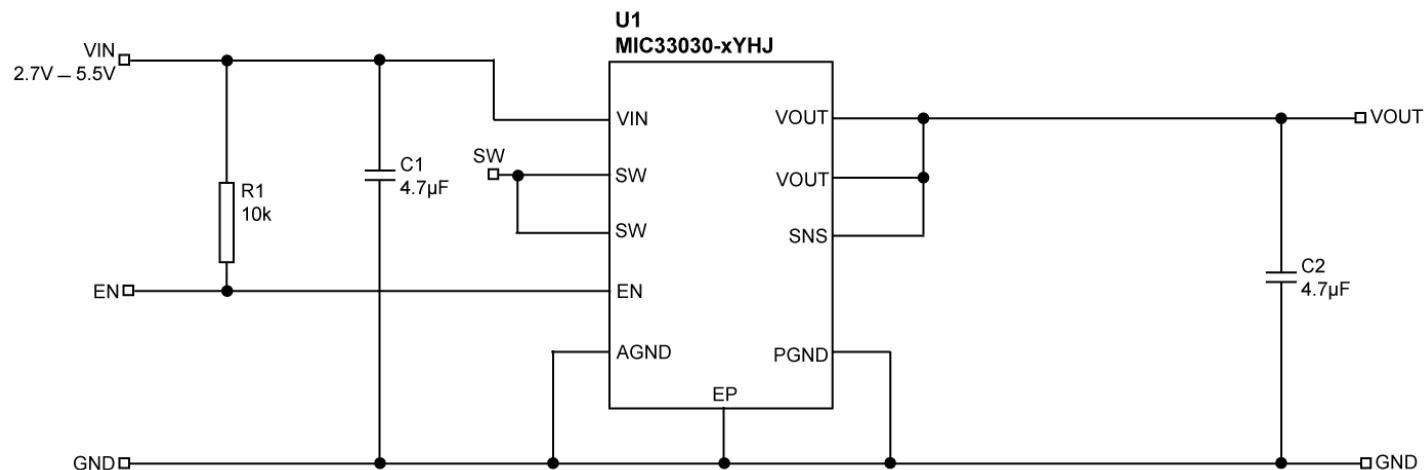

Bill of Materials

Item	Part Number	Manufacturer	Description	Qty.
C1, C2	C1608X5R0J475K	TDK ⁽¹⁾	4.7µF Ceramic Capacitor, 6.3V, X5R, Size 0603	2
R1	CRCW06031002FKEA	Vishay ⁽²⁾	Resistor, 10k, Size 0603	1
U1	MIC33030-xYHJ	Micrel, Inc. ⁽³⁾	8MHz 400mA Integrated Inductor Buck Regulator with HyperLight Load™	1

Notes:

1. TDK: www.tdk.com.
2. Vishay: www.vishay.com.
3. Micrel, Inc.: www.micrel.com.

MIC33030 Typical Application Circuit (Adjustable 1.8V)

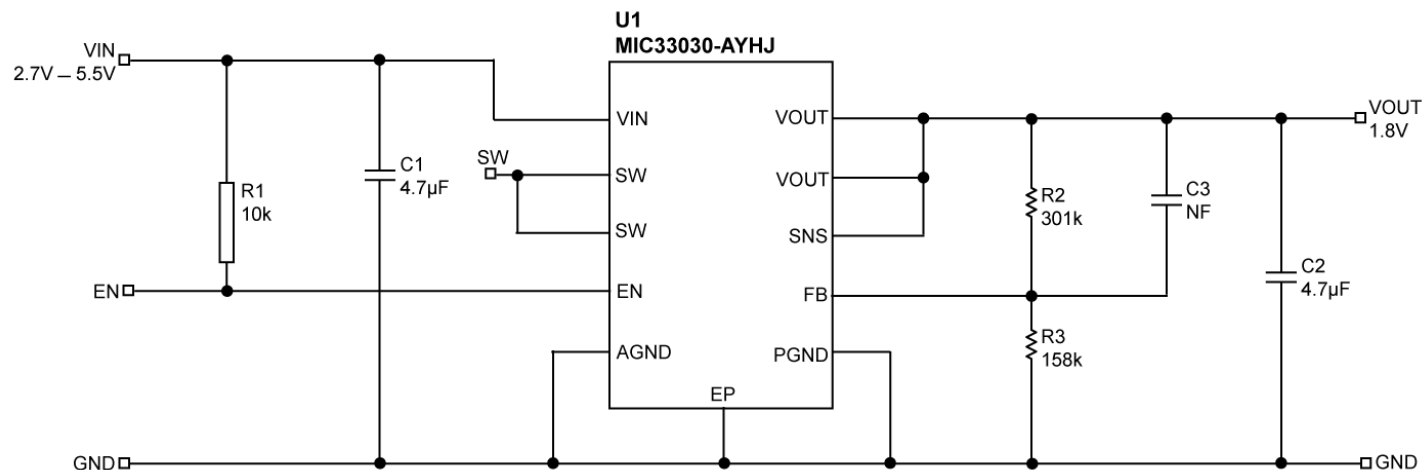

Bill of Materials

Item	Part Number	Manufacturer	Description	Qty.
C1, C2	C1608X5R0J475K	TDK ⁽¹⁾	4.7µF Ceramic Capacitor, 6.3V, X5R, Size 0603	2
R1	CRCW06031002FT1	Vishay ⁽²⁾	10k Ω, 1%, Size 0603	1
R2	CRCW06033013FT1	Vishay ⁽²⁾	301kΩ, 1%, Size 0603	1
R3	CRCW06031583FT1	Vishay ⁽²⁾	158kΩ, 1%, Size 0603	1
U1	MIC33030-AYHJ	Micrel, Inc. ⁽³⁾	8MHz 400mA Integrated Inductor Buck Regulator with HyperLight Load™	1

Notes:

1. TDK: www.tdk.com.
2. Vishay: www.vishay.com.
3. Micrel, Inc.: www.micrel.com.

PCB Layout Recommendations

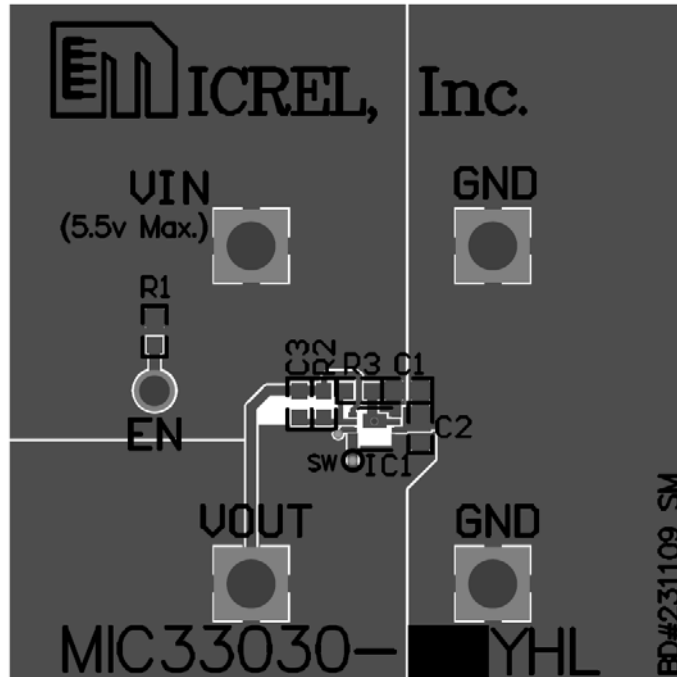

Fixed Top Layer

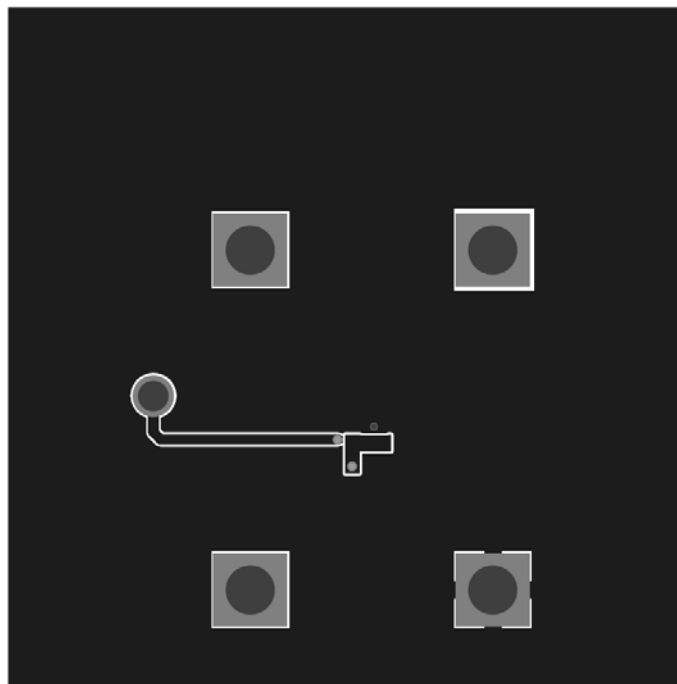

Fixed Bottom Layer

Package Information

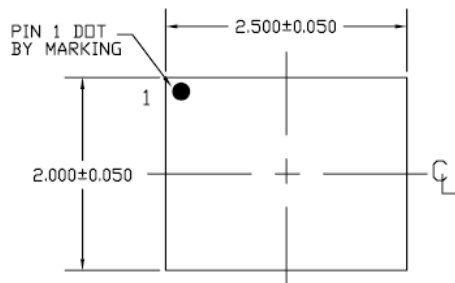

TOP VIEW

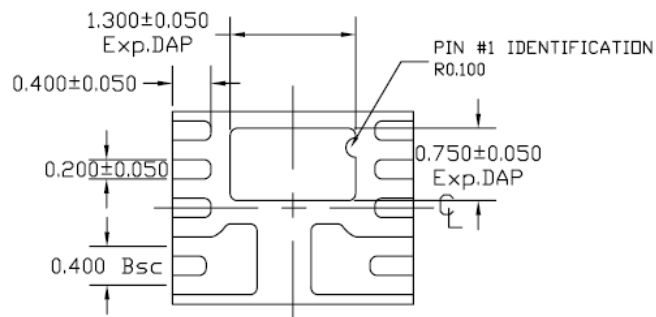

BOTTOM VIEW

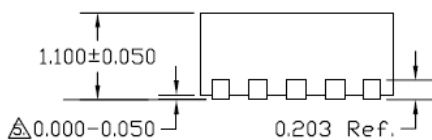

SIDE VIEW

- NOTE:
1. ALL DIMENSIONS ARE IN MILLIMETERS.
 2. MAX. PACKAGE WARPAGE IS 0.05 mm.
 3. MAXIMUM ALLOWABLE BURRS IS 0.076 mm IN ALL DIRECTIONS.
 4. PIN #1 ID ON TOP WILL BE LASER/INK MARKED.
- ⚠ APPLIED ONLY FOR TERMINALS.

10-Pin (2.5mm x 2.0mm) MLF® (HJ)

Recommended Landing Pattern

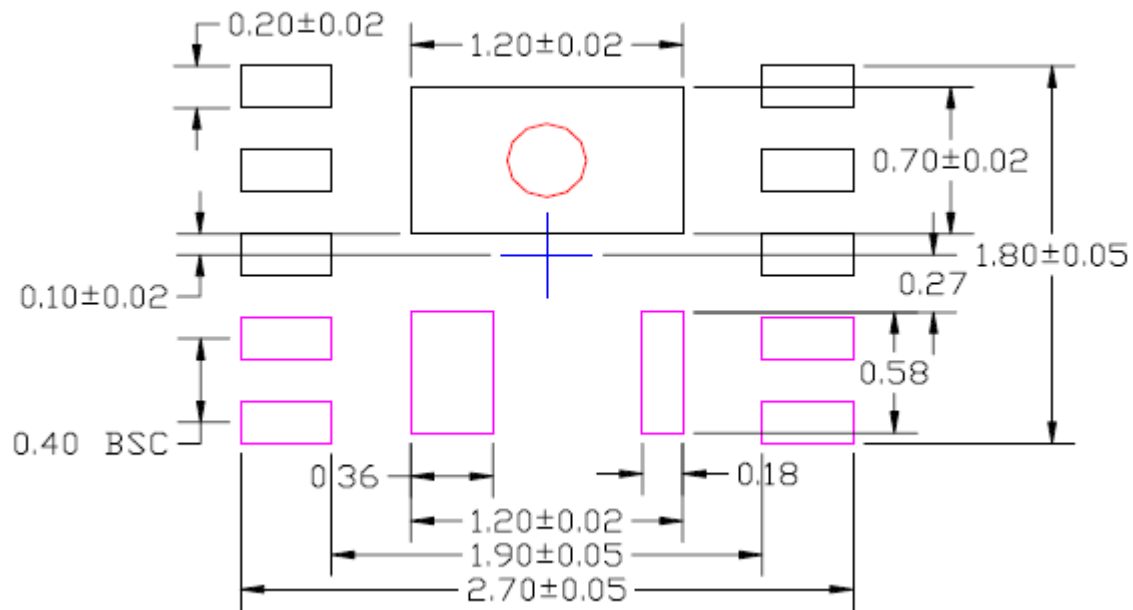

10-Pin 2.5mm x 2mm MLF®

All dimensions in mm. Tolerance ± 0.05 mm unless noted otherwise.

 The red circle indicates a Thermal Via. The Size should be .300-.350 mm in diameter and it should be connected to GND plane for maximum thermal performance.

Magenta colored pads: Indicate different potential; DO NOT connect to GND plane.

MICREL, INC. 2180 FORTUNE DRIVE SAN JOSE, CA 95131 USA

TEL +1 (408) 944-0800 FAX +1 (408) 474-1000 WEB <http://www.micrel.com>

Micrel makes no representations or warranties with respect to the accuracy or completeness of the information furnished in this data sheet. This information is not intended as a warranty and Micrel does not assume responsibility for its use. Micrel reserves the right to change circuitry, specifications and descriptions at any time without notice. No license, whether express, implied, arising by estoppel or otherwise, to any intellectual property rights is granted by this document. Except as provided in Micrel's terms and conditions of sale for such products, Micrel assumes no liability whatsoever, and Micrel disclaims any express or implied warranty relating to the sale and/or use of Micrel products including liability or warranties relating to fitness for a particular purpose, merchantability, or infringement of any patent, copyright or other intellectual property right.

Micrel Products are not designed or authorized for use as components in life support appliances, devices or systems where malfunction of a product can reasonably be expected to result in personal injury. Life support devices or systems are devices or systems that (a) are intended for surgical implant into the body or (b) support or sustain life, and whose failure to perform can be reasonably expected to result in a significant injury to the user. A Purchaser's use or sale of Micrel Products for use in life support appliances, devices or systems is a Purchaser's own risk and Purchaser agrees to fully indemnify Micrel for any damages resulting from such use or sale.

© 2010 Micrel, Incorporated.