

\*RoHS COMPLIANT

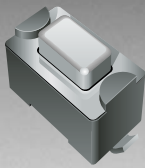

**BOURNS®**

## Features

- Available sharp click feel with a positive tactile feedback
- Ultraminiature and lightweight structure suitable for high density mounting
- Economical
- Reliable
- RoHS compliant\*



The STS Series is currently available, although not recommended for new designs.

## STS Series - Ultraminiature Tactile Switch

### Electrical Characteristics

Electrical Life  
 .....50,000 Cycles for 160 gf, 320 gf  
 Rating .....50 mA, 12 VDC  
 Contact Resistance .....100 mΩ max.  
 Insulation Resistance  
 .....100 MΩ min. @ 500 VDC  
 Dielectric Strength .....250 VAC/1 minute  
 Contact Arrangement .....SPST

### Environmental Characteristics

Operation Temperature Range  
 .....-25 °C to +70 °C  
 Storage Temperature Range  
 .....-30 °C to +80 °C  
 Vibration Test  
 MIL-STD-202F Method 201A  
 Frequency .....10-55-10 Hz/1 minute  
 Directions  
 .....X,Y,Z, three mutually perpendicular directions  
 Time .....2 hours each direction  
 Shock Test  
 MIL-STD-202F Method 213B  
 Condition A  
 Gravity .....50 G (peak value), 11 msec  
 Direction and Times .....6 sides and 3 times in each direction

### Physical Characteristics

Cover Materials .....Stainless Steel  
 Base Materials .....UL94V-0 Nylon  
 Thermoplastic  
 Actuator .....UL94V-0 Nylon  
 High-Temperature Thermoplastic  
 Contact Disc .....Stainless steel  
 with silver cladding  
 Terminals .....Brass with silver cladding

### How to Order

**STS M - 3 1 - S TR**

Model \_\_\_\_\_  
 Style \_\_\_\_\_  
 M = Surface Mount "J" Style  
 G = Surface Mount "G" Style  
 H = Through-hole "H" Style  
 Product Size \_\_\_\_\_  
 3 = 3.5 mm wide x 6 mm long  
 Height \_\_\_\_\_  
 1 = 4.3 mm  
 2 = 5.0 mm  
 Color of Stem for Actuating Force \_\_\_\_\_  
 N = Brown, 160 g  
 R = Red, 260 g  
 S = Salmon, 320 g  
 Y = Yellow, 520 g  
 Packaging Option \_\_\_\_\_  
 = Std. Packaging - 135 pcs./tube  
 TR = Tape & Reel Packaging -  
 31 - 1800 pcs./reel (STSM & STSG only)  
 32 - 1600 pcs./reel (STSM & STSG only)

### Product Dimensions

STSM

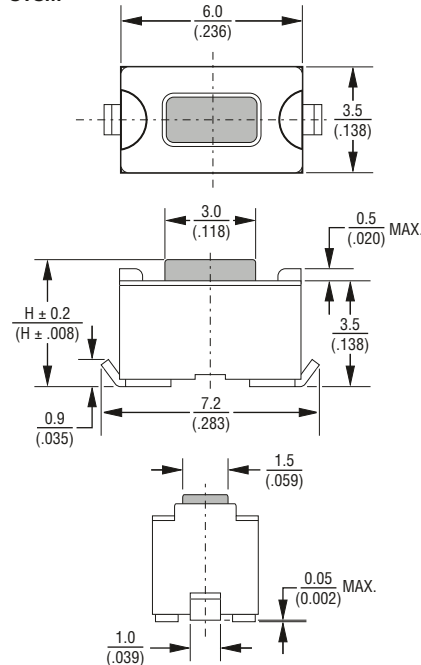

STSG

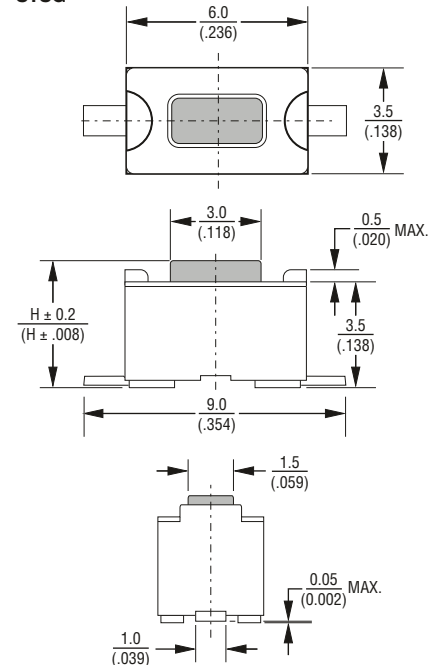

### Circuit Diagram

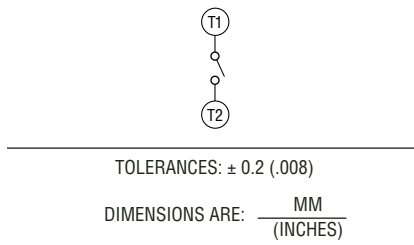

### Reflow Soldering Profile

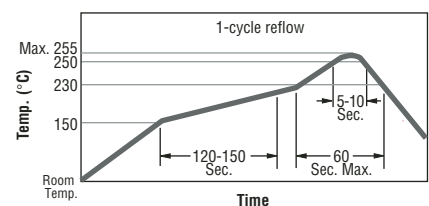

\*RoHS Directive 2002/95/EC Jan 27 2003 including Annex. Specifications are subject to change without notice. Customers should verify actual device performance in their specific applications.

# STS Series - Ultraminiature Tactile Switch

**BOURNS®**

## Product Dimensions

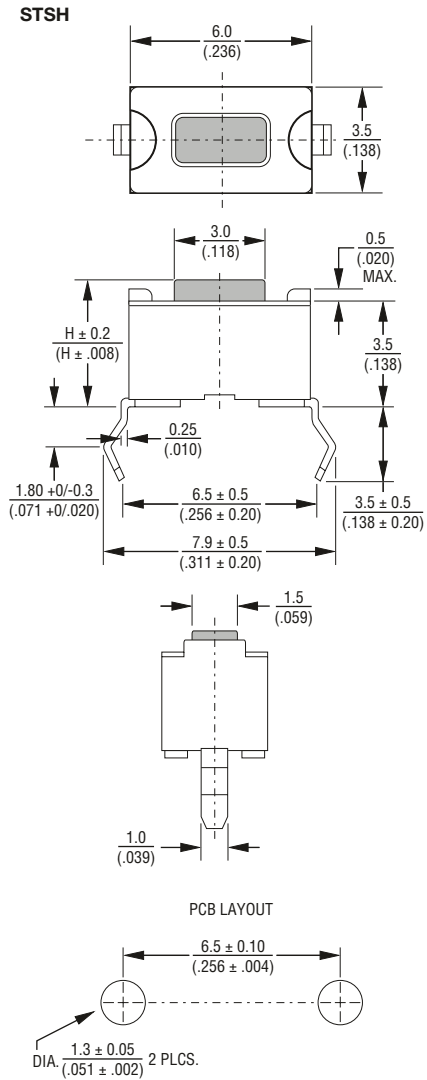

## Packaging Specifications

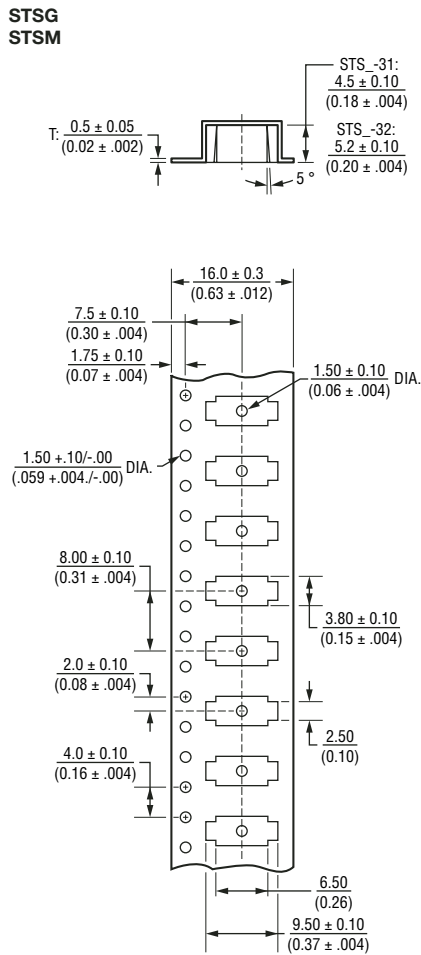

## STSH

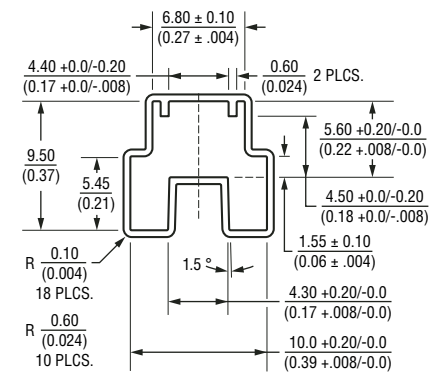

TOLERANCES: ± 0.2 (.008)

DIMENSIONS ARE:  $\frac{\text{MM}}{\text{(INCHES)}}$

REV. 02/06

Specifications are subject to change without notice.  
Customers should verify actual device performance in their specific applications.