



**ANALOG
DEVICES**

±15 kV ESD Protected, 3.3 V Single-Channel RS-232 Line Driver/Receiver

ADM3101E

FEATURES

- 460 kbps data rate
- 1 Tx and 1 Rx
- Meets EIA/TIA-232E specifications
- 0.1 μF charge pump capacitors
- Contact discharge: ±8 kV
- Air gap discharge: ±15 kV

APPLICATIONS

- General-purpose RS-232 data links
- Industrial/telecommunications diagnostics ports

GENERAL DESCRIPTION

The ADM3101E is a high speed, single-channel RS-232/V.28 transceiver interface device that operates from a single 3.3 V power supply. Low power consumption makes it ideal for battery-powered portable instruments.

The ADM3101E conforms to the EIA/TIA-232E and CCITT V.28 specifications and operates at data rates up to 460 kbps.

All RS-232 (T_{OUT} and R_{IN}) and CMOS (T_{IN} and R_{OUT}) inputs and outputs are protected against electrostatic discharges (up to ±15 kV ESD protection).

FUNCTIONAL BLOCK DIAGRAM

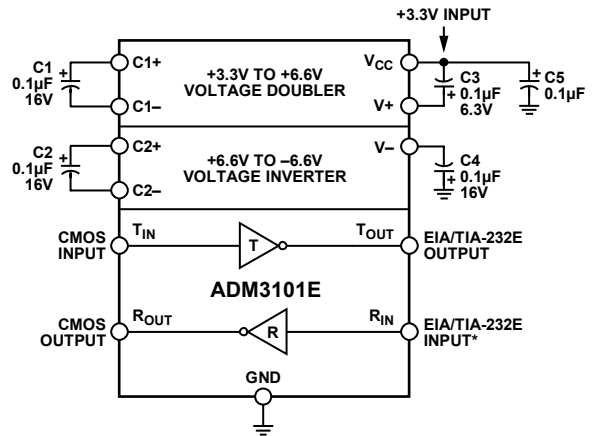

*INTERNAL 5kΩ PULL-DOWN RESISTOR ON THE RS-232 INPUT.

Figure 1.

10/07/06-001

This device is ideally suited for operation in electrically harsh environments, or where RS-232 cables are frequently being plugged/unplugged with the ±15 kV ESD protection of the I/O pins of the ADM3101E.

Four external 0.1 μF charge pump capacitors are used for the voltage doubler/inverter, permitting operation from a single 3.3 V supply.

The ADM3101E is available in a 12-lead LFCSP and is specified over the -40°C to +85°C temperature range.

Rev. A

Information furnished by Analog Devices is believed to be accurate and reliable. However, no responsibility is assumed by Analog Devices for its use, nor for any infringements of patents or other rights of third parties that may result from its use. Specifications subject to change without notice. No license is granted by implication or otherwise under any patent or patent rights of Analog Devices. Trademarks and registered trademarks are the property of their respective owners.

One Technology Way, P.O. Box 9106, Norwood, MA 02062-9106, U.S.A.
Tel: 781.329.4700 www.analog.com
Fax: 781.461.3113 ©2007 Analog Devices, Inc. All rights reserved.

TABLE OF CONTENTS

Features	1	Pin Configuration and Function Descriptions.....	5
Applications.....	1	Typical Performance Characteristics	6
Functional Block Diagram	1	General Description	8
General Description	1	Circuit Description	8
Revision History	2	High Baud Rate.....	9
Specifications.....	3	Outline Dimensions	10
Absolute Maximum Ratings.....	4	Ordering Guide	10
ESD Caution.....	4		

REVISION HISTORY

10/07—Rev. 0 to Rev. A

Changes to Figure 1	1
Changes to Table 1, RS-232 Receiver Section	3
Changes to Table 3.....	5
Changes to Figure 11	8

5/07—Revision 0: Initial Version

SPECIFICATIONS

$V_{CC} = 3.3 \text{ V} \pm 0.3 \text{ V}$, $C1$ to $C4 = 0.1 \mu\text{F}$, $-40^\circ\text{C} \leq T_A \leq +85^\circ\text{C}$, unless otherwise noted.

Table 1.

Parameter	Min	Typ	Max	Unit	Test Conditions/Comments
DC CHARACTERISTICS					
Operating Voltage Range	3.0	3.3	5.5	V	
Power Supply Current, V_{CC}		1.5	2.6	mA	No load
		5	7	mA	$R_L = 3 \text{ k}\Omega$ to GND
LOGIC					
Input Logic Threshold Low, V_{INL}			0.6	V	T_{IN}
Input Logic Threshold High, V_{INH}	1.4			V	T_{IN}
Input Logic Threshold Low, V_{INL}			0.8	V	$T_{IN}, V_{CC} = 5.0 \text{ V} \pm 0.5 \text{ V}$
Input Logic Threshold High, V_{INH}	2.0			V	$T_{IN}, V_{CC} = 5.0 \text{ V} \pm 0.5 \text{ V}$
CMOS Output Voltage Low, V_{OL}			0.4	V	$I_{OUT} = 1.6 \text{ mA}$
CMOS Output Voltage High, V_{OH}	$V_{CC} - 0.6$			V	$I_{OUT} = -1 \text{ mA}$
Logic Pull-Up Current		5	12	μA	$T_{IN} = \text{GND to } V_{CC}$
RS-232 RECEIVER					
EIA/TIA-232E Input Voltage Range ¹	-30		+30	V	
EIA/TIA-232E Input Threshold Low	0.6	1.3		V	$V_{CC} = 3.0 \text{ V to } 5.5 \text{ V}$
EIA/TIA-232E Input Threshold High		1.6	2.4	V	
EIA/TIA-232E Input Hysteresis		0.4		V	
EIA/TIA-232E Input Resistance	3	5	7	$\text{k}\Omega$	
RS-232 TRANSMITTER					
Output Voltage Swing (RS-232)	± 5.0	± 5.7		V	$V_{CC} = 3.3 \text{ V to } 5.5 \text{ V}$; transmitter output loaded with $3 \text{ k}\Omega$ to ground
Output Voltage Swing (RS-562)	± 4.5			V	$V_{CC} = 3.0 \text{ V}$
Transmitter Output Resistance	300			Ω	$V_{CC} = 0 \text{ V}, V_{OUT} = \pm 2 \text{ V}^1$
RS-232 Output Short-Circuit Current		± 15		mA	
TIMING CHARACTERISTICS					
Maximum Data Rate	460			kbps	$V_{CC} = 3.3 \text{ V}, R_L = 3 \text{ k}\Omega$ to $7 \text{ k}\Omega, C_L = 50 \text{ pF to } 1000 \text{ pF}$
Receiver Propagation Delay					
t_{PHL}		0.4		μs	
t_{PLH}		0.4		μs	
Transmitter Propagation Delay		600		ns	$R_L = 3 \text{ k}\Omega, C_L = 1000 \text{ pF}$
Transmitter Skew		80		ns	
Receiver Skew		70		ns	
Transition Region Slew Rate	5.5	10	30	$\text{V}/\mu\text{s}$	$+3 \text{ V to } -3 \text{ V or } -3 \text{ V to } +3 \text{ V}, V_{CC} = +3.3 \text{ V}, R_L = 3 \text{ k}\Omega, C_L = 1000 \text{ pF}, T_A = 25^\circ\text{C}^1$
ESD PROTECTION					
(RS-232 and CMOS I/O Pins)		± 15		kV	Human body model air discharge
		± 8		kV	Human body model contact discharge

¹ Guaranteed by design.

ABSOLUTE MAXIMUM RATINGS

$T_A = 25^\circ\text{C}$, unless otherwise noted.

Table 2.

Parameter	Rating
V_{CC}	-0.3 V to +6 V
V_+	$(V_{CC} - 0.3\text{ V})$ to +13 V
V_-	+0.3 V to -13 V
Input Voltages	
T_{IN}	-0.3 V to $(V_+ + 0.3\text{ V})$
R_{IN}	$\pm 30\text{ V}$
Output Voltages	
T_{OUT}	$\pm 15\text{ V}$
R_{OUT}	-0.3 V to $(V_{CC} + 0.3\text{ V})$
Short-Circuit Duration	
T_{OUT}	Continuous
Package Information	
θ_{JA} , Thermal Impedance	61.1°C/W
Operating Temperature Range	
Industrial (A Version)	-40°C to $+85^\circ\text{C}$
Storage Temperature Range	-65°C to $+150^\circ\text{C}$
Pb-Free Temperature (Soldering, 10 sec)	260°C

Stresses above those listed under Absolute Maximum Ratings may cause permanent damage to the device. This is a stress rating only; functional operation of the device at these or any other conditions above those indicated in the operational section of this specification is not implied. Exposure to absolute maximum rating conditions for extended periods may affect device reliability.

ESD CAUTION



ESD (electrostatic discharge) sensitive device.

Charged devices and circuit boards can discharge without detection. Although this product features patented or proprietary protection circuitry, damage may occur on devices subjected to high energy ESD. Therefore, proper ESD precautions should be taken to avoid performance degradation or loss of functionality.

PIN CONFIGURATION AND FUNCTION DESCRIPTIONS

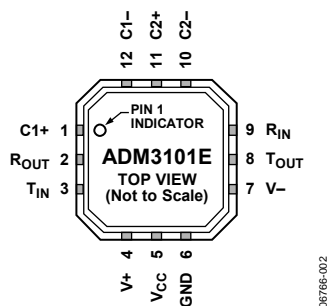

Figure 2. Pin Configuration

Table 3. Pin Function Descriptions

Pin No.	Mnemonic	Description
1, 12	C1+, C1-	Positive and Negative Connections for Charge Pump Capacitor. External Capacitor C1 is connected between these pins; a 0.1 μF capacitor is recommended, but larger capacitors up to 10 μF can be used.
2	R _{OUT}	Receiver Output. This outputs CMOS output logic levels.
3	T _{IN}	Transmitter (Driver) Input. This input accepts TTL/CMOS levels.
4	V+	Internally Generated Positive Supply (+6 V Nominal).
5	V _{CC}	Power Supply Input, 3.0 V to 5.5 V.
6	GND	Ground. Must be connected to 0 V.
7	V-	Internally Generated Negative Supply (-6 V Nominal).
8	T _{OUT}	Transmitter (Driver) Output. This outputs RS-232 signal levels (typically ± 6 V).
9	R _{IN}	Receiver Input. This input accepts RS-232 signal levels. An internal 5 k Ω pull-down resistor to GND is connected on the input.
11, 10	C2+, C2-	Positive and Negative Connections for Charge Pump Capacitor. External Capacitor C2 is connected between these pins; a 0.1 μF capacitor is recommended, but larger capacitors up to 10 μF can be used.

TYPICAL PERFORMANCE CHARACTERISTICS

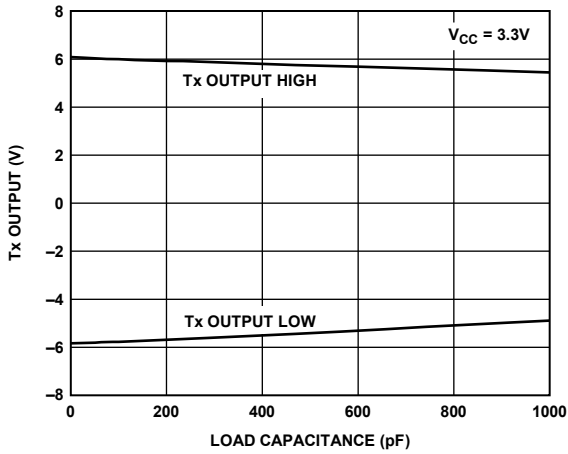

Figure 3. Transmitter Output Voltage High/Low vs. Load Capacitance @ 460 kbps

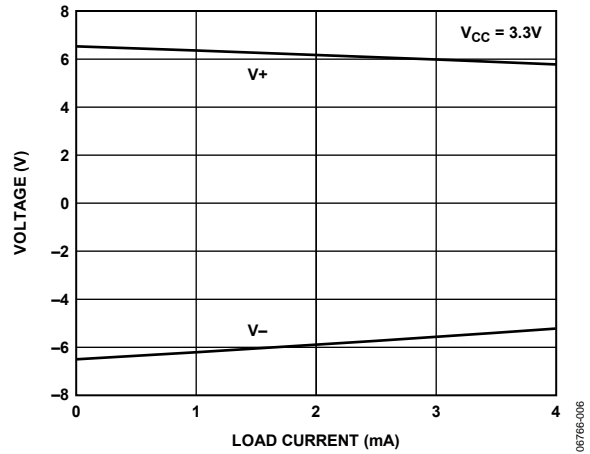

Figure 6. Charge Pump V+, V- vs. Load Current

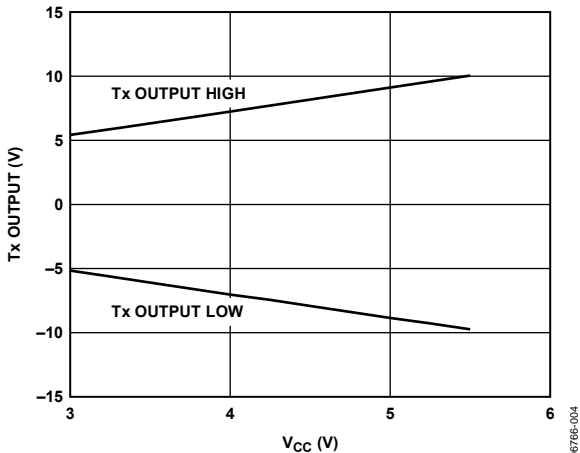

Figure 4. Transmitter Output Voltage vs. V_{CC} , $R_L = 3\text{ k}\Omega$

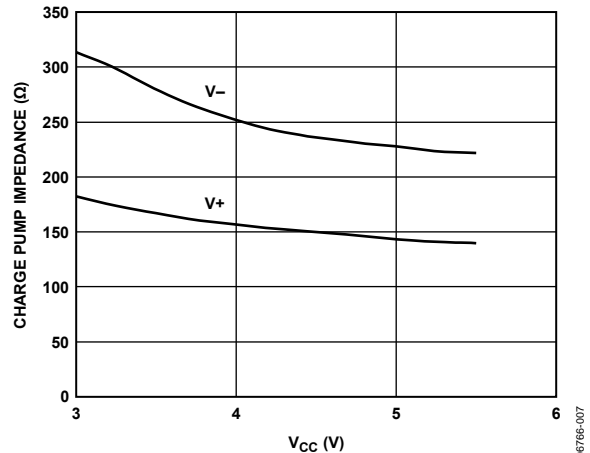

Figure 7. Charge Pump Impedance vs. V_{CC}

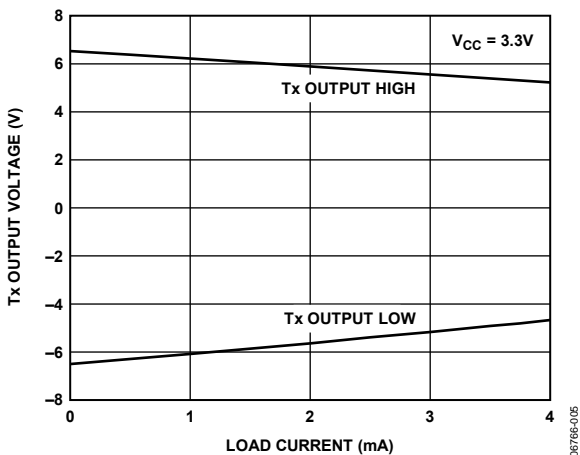

Figure 5. Transmitter Output Voltage Low/High vs. Load Current

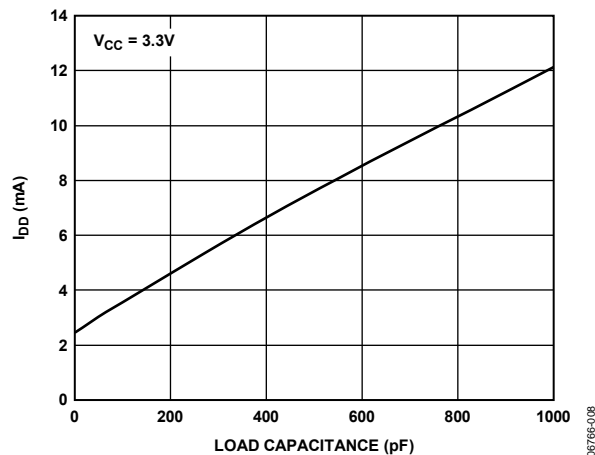

Figure 8. Power Supply Current vs. Load Capacitance

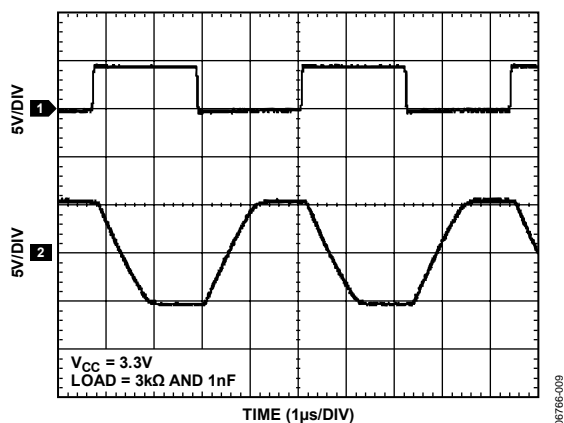

Figure 9. 460 kbps Data Transmission

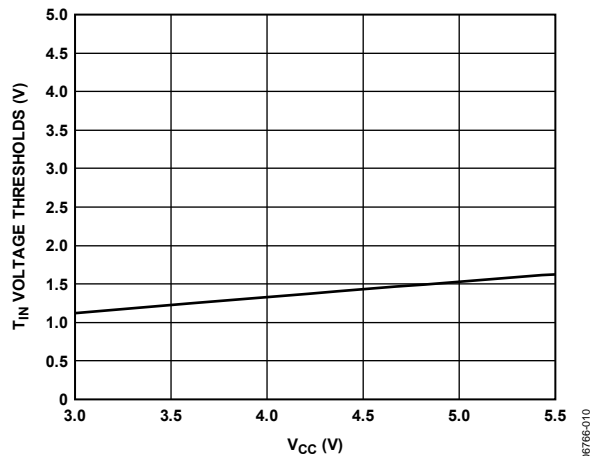

Figure 10. T_{IN} Voltage Threshold vs. V_{CC}

GENERAL DESCRIPTION

The ADM3101E is a single-channel RS-232 line driver/receiver. Step-up voltage converters, coupled with level shifting transmitters and receivers, allow RS-232 levels to be developed while operating from a single 3.3 V supply.

CMOS technology is used to keep the power dissipation to an absolute minimum, allowing maximum battery life in portable applications.

CIRCUIT DESCRIPTION

The internal circuitry consists of the following main sections:

- Charge pump voltage converter
- A 3.3 V logic to EIA/TIA-232E transmitter
- A EIA/TIA-232E to 3.3 V logic receiver

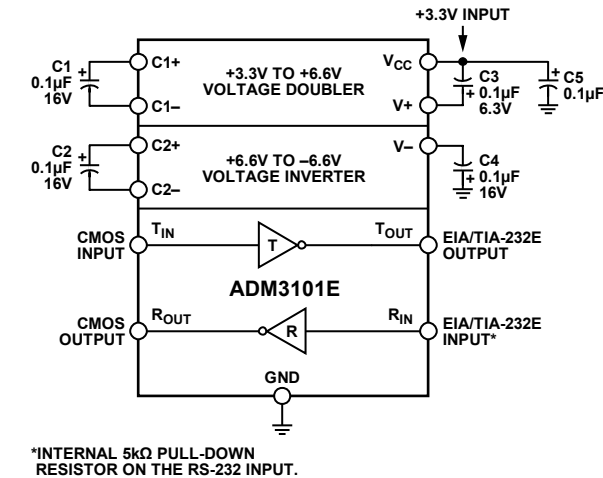

Figure 11. ADM3101E Typical Operating Circuit

Charge Pump Voltage Converter

The charge pump voltage converter consists of a 200 kHz oscillator and a switching matrix. The converter generates a ± 6.6 V supply from the input 3.3 V level, which is done in two stages by using a switched capacitor technique, as illustrated in Figure 12 and Figure 13. First, the 3.3 V input supply is doubled to 6.6 V by using C1 as the charge storage element. The +6.6 V level is then inverted to generate -6.6 V using C2 as the storage element. C3 is shown connected between V+ and VCC, but is equally effective if connected between V+ and GND.

The C3 and C4 capacitors are used to reduce the output ripple. The values are not critical and can be increased, if desired.

If desired, larger capacitors (up to 10 μ F) can be used in place of the C1, C2, C3, and C4 capacitors.

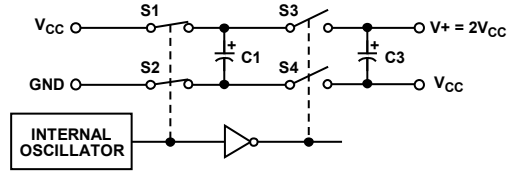

Figure 12. Charge Pump Voltage Doubler

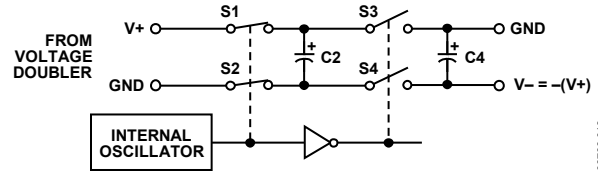

Figure 13. Charge Pump Voltage Inverter

3.3 V Logic to EIA/TIA-232E Transmitter

The transmitter driver converts the 3.3 V logic input levels into RS-232 output levels. When driving an RS-232 load with $V_{CC} = 3.3$ V, the output voltage swing is typically ± 6 V. Internally, the T_{IN} pin has a weak pull-up that allows it to be driven by an open-drain output, but the maximum operating data rate is reduced when the T_{IN} pin is driven by an open-drain pin.

EIA/TIA-232E to 3.3 V Logic Receiver

The receiver is an inverting level shifter that accepts the RS-232 input level and translates it into a 3.3 V logic output level. The input has an internal 5 k Ω pull-down resistor to ground and is also protected against overvoltages of up to ± 30 V. An unconnected input is pulled to 0 V by the internal 5 k Ω pull-down resistor, which, therefore, results in a Logic 1 output level for an unconnected input or for an input connected to GND.

The receiver has a Schmitt trigger input with a hysteresis level of 0.4 V, which ensures error-free reception for both a noisy input and for an input with slow transition times.

CMOS Input Voltage Thresholds

The CMOS input and output pins (T_{IN} and R_{OUT}) of the ADM3101E are designed to interface with 1.8 V logic thresholds when $V_{CC} = 3.3$ V.

The CMOS input and output pins (T_{IN} and R_{OUT}) of the ADM3101E are also designed to interface with TTL/CMOS logic thresholds when $V_{CC} = 5$ V.

ESD Protection on RS-232 and CMOS I/O Pins

All RS-232 (T_{OUT} and R_{IN}) and CMOS (T_{IN} and R_{OUT}) inputs and outputs are protected against electrostatic discharges (up to ± 15 kV).

HIGH BAUD RATE

The ADM3101E features high slew rates, permitting data transmission at rates well in excess of the EIA/RS-232 specifications. The RS-232 voltage levels are maintained at data rates up to

460 kbps, even under worst-case loading conditions, when T_{IN} is driven by a push-pull output. The slew rate is internally controlled to less than 30 V/ μ s to minimize EMI interference.

ADM3101E

OUTLINE DIMENSIONS

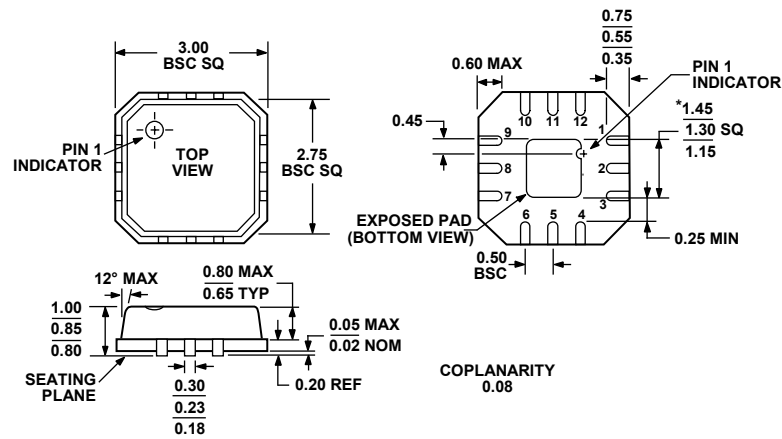

*COMPLIANT TO JEDEC STANDARDS MO-220-VEED-1 EXCEPT FOR EXPOSED PAD DIMENSION.

Figure 14. 12-Lead Lead Frame Chip Scale Package [LFCSP_VQ]
3 mm × 3 mm Body, Very Thin Quad
(CP-12-1)
Dimensions shown in millimeters

ORDERING GUIDE

Model	Temperature Range	Package Description	Package Option	Branding
ADM3101EACPZ-REEL ¹	-40°C to +85°C	12-Lead Lead Frame Chip Scale Package [LFCSP_VQ]	CP-12-1	MA6
ADM3101EACPZ-250R7 ¹	-40°C to +85°C	12-Lead Lead Frame Chip Scale Package [LFCSP_VQ]	CP-12-1	MA6

¹ Z = RoHS Compliant Part.

NOTES

ADM3101E

NOTES