

AMD8513/X

USB-to-10/100 Mbps Ethernet LAN Controller

Communications



Never stop thinking.

Edition 2005-12-05

**Published by Infineon Technologies AG,
St.-Martin-Strasse 53,
81669 München, Germany**

**© Infineon Technologies AG 2005.
All Rights Reserved.**

Attention please!

The information herein is given to describe certain components and shall not be considered as a guarantee of characteristics.

Terms of delivery and rights to technical change reserved.

We hereby disclaim any and all warranties, including but not limited to warranties of non-infringement, regarding circuits, descriptions and charts stated herein.

Information

For further information on technology, delivery terms and conditions and prices please contact your nearest Infineon Technologies Office (www.infineon.com).

Warnings

Due to technical requirements components may contain dangerous substances. For information on the types in question please contact your nearest Infineon Technologies Office.

Infineon Technologies Components may only be used in life-support devices or systems with the express written approval of Infineon Technologies, if a failure of such components can reasonably be expected to cause the failure of that life-support device or system, or to affect the safety or effectiveness of that device or system. Life support devices or systems are intended to be implanted in the human body, or to support and/or maintain and sustain and/or protect human life. If they fail, it is reasonable to assume that the health of the user or other persons may be endangered.

USB-to-10/100 Mbps Ethernet LAN Controller

Revision History: 2005-12-05, Rev. 1.21

Previous Version:

Page/Date	Subjects (major changes since last revision)
2001-12	Rev. 0.1: Preliminary
2002-01	Rev. 1.0: Rearrange
2002-06	Rev. 1.1: 1.VAAREf I/O is power pin, not input pin in P.7 2.GNDRef I/O is power pin, not input pin in P.7 3.Modify Pin Assignment Diagram P.5 4.Make small correction on P1, P2, P5, P10, P13, P17, P19, P35, P37, P38
2002-06	Rev 1.2: 1.Remove power consumption @ mode 1 in P.2 2.Change power consumption in P.33 3.Add layout guide in Appendix A
2005-09-13	Rev 1.21: when changed to the new Infineon format
2005-12-05	Minor change. Included Green package information

Trademarks

ABM[®], ACE[®], AOP[®], ARCOFI[®], ASM[®], ASP[®], DigiTape[®], DuSLIC[®], EPIC[®], ELIC[®], FALC[®], GEMINAX[®], IDEC[®], INCA[®], IOM[®], IPAT[®]-2, ISAC[®], ITAC[®], IWE[®], IWORX[®], MUSAC[®], MuSLIC[®], OCTAT[®], OptiPort[®], POTSWIRE[®], QUAT[®], QuadFALC[®], SCOUT[®], SICAT[®], SICOFI[®], SIDEC[®], SLICOFI[®], SMINT[®], SOCRATES[®], VINETIC[®], 10BaseV[®], 10BaseVX[®] are registered trademarks of Infineon Technologies AG. 10BaseS[™], EasyPort[™], VD Lite[™] are trademarks of Infineon Technologies AG. Microsoft[®] is a registered trademark of Microsoft Corporation, Linux[®] of Linus Torvalds, Visio[®] of Visio Corporation, and FrameMaker[®] of Adobe Systems Incorporated.

Table of Contents

	Table of Contents	4
	List of Figures	6
	List of Tables	7
1	Product Overview	9
1.1	Package Information	9
1.2	Features	9
2	Interface Description	11
2.1	Pin Assignment Diagram	11
2.2	Pin Description by Function	11
2.2.1	Host Interface	12
2.2.2	Physical Interface	12
2.2.3	LED Interface	13
2.2.4	EEPROM Interface	14
2.2.5	Miscellaneous	14
2.2.6	POWER USB	14
2.2.7	POWER	15
2.3	Block Diagram	15
3	Function Description	16
3.1	USB Interface	16
3.1.1	SIE	16
3.1.2	USB Command & EP Decoder	16
3.2	FIFO Controller	16
3.3	TX FIFO and RX FIFO	16
3.4	10/100M Ethernet PHY	16
4	USB Device Endpoint Operation	16
4.1	Endpoint 0	16
4.2	Endpoint 1 Bulk IN	16
4.2.1	Endpoint 2 Bulk OUT	17
4.2.2	Endpoint 3 Interrupt IN	18
5	USB Commands	18
5.1	USB Command	18
5.1.1	Get Register (Vendor Specific) Single/Burst Read	18
5.1.2	Set Register (Vendor Specific) Burst Write	18
5.1.3	Get Status (Device)	19
5.1.4	Get Status (Interface)	20
5.1.5	Get Status (EP0)	20
5.1.6	Get Status (EP1) Bulk In	20
5.1.7	Get Status (EP2) Bulk OUT	20
5.1.8	Get Status (EP3) Interrupt IN	21
5.1.9	Get Descriptor (Device) Total 18-byte	21
5.1.10	Get Descriptor (Configuration) Total 39-byte	22
5.1.11	Get Descriptor (String) Index 0, LanguageID Code	23
5.1.12	Get Descriptor (String) Index 1, Manufacture	23
5.1.13	Get Descriptor (String) Index 2, Product	23
5.1.14	Get Descriptor (String) Index 3, Serial No.	23
5.1.15	Get Configuration	24

Table of Contents

5.1.16	Get Interface	24
5.1.17	Clear Feature (Device) Remote Wakeup	24
5.1.18	Set Feature (Device) Remote Wakeup	24
5.1.19	Clear Feature (EP 0, 1, 2, 3) Halt	25
5.1.20	Set Feature (EP 0, 1, 2, 3) Halt	25
6	Registers Description	26
6.1	System Registers	26
6.1.1	System Registers	30
6.2	PHY Registers Description	64
6.2.1	PHY Registers	66
7	Electrical Characteristics	74
7.1	Absolute Maximum Ratings	74
7.2	Operating Condition	74
7.3	DC Specifications	74
7.3.1	USB Interface DC Specification	74
8	EEPROM Interface DC Specification	75
8.1	Recommended Operating Conditions	75
8.2	GPIO Interface DC Specification	75
9	Timing	75
9.1	Reset Timing	76
9.2	USB Interface Timing	76
9.3	EEPROM Interface Timing	76
10	EEPROM Interface & Example	77
10.1	Example	78
11	Package	80
12	Appendix Layout Guide	84
	References	88
	Terminology	89

List of Figures

Figure 1	Pin Diagram	11
Figure 2	Block Diagram	15
Figure 3	Packet Form when Receive	17
Figure 4	Packet Form when Transmit	18
Figure 5	EEPROM Interface Timing	77
Figure 6	Package	80
Figure 7	Placement 1	84
Figure 8	Placement 2	84
Figure 9	Trace Routing 1	85
Figure 10	Trace Routing 2	85
Figure 11	Trace Routing 3	86
Figure 12	Power and Ground 1	86
Figure 13	Power and Ground 2	86
Figure 14	Power and Ground 3	87

List of Tables

Table 1	Abbreviations for Pin Type	11
Table 2	Abbreviations for Buffer Type	12
Table 3	Host Interface	12
Table 4	Physical Interface	13
Table 5	LED Interface	13
Table 6	Mapping between LED action and EEPROM 0B[7:6] setting	13
Table 7	EEPROM Interface	14
Table 8	Miscellaneous	14
Table 9	Power USB	15
Table 10	Power	15
Table 11	USB Received Status	17
Table 12	USB Packet Format	17
Table 13	Interrupt Packet Form	18
Table 14	Interrupt Packet Form	18
Table 15	Setup Stage	18
Table 16	Data Stage	18
Table 17	Setup Stage	19
Table 18	Data Stage	19
Table 19	Setup Stage	19
Table 20	Setup Stage	19
Table 21	1st OUT Transfer	19
Table 22	2nd OUT Transfer	19
Table 23	3rd OUT Transfer	19
Table 24	Setup Stage	19
Table 25	Data Stage	20
Table 26	Setup Stage	20
Table 27	Data Stage	20
Table 28	Setup Stage	20
Table 29	Data Stage	20
Table 30	Setup Stage	20
Table 31	Data Stage	20
Table 32	Setup Stage	21
Table 33	Data Stage	21
Table 34	Setup Stage	21
Table 35	Data Stage	21
Table 36	Setup Stage	21
Table 37	Data Stage: wLength Field Specifies the Total byte Count to Return	1 21
Table 38	Data Stage: wLength Field Specifies the Total byte Count to Return	2 21
Table 39	Data Stage: wLength Field Specifies the Total byte Count to Return	3 21
Table 40	Setup Stage	22
Table 41	Configuration Descriptor	1 22
Table 42	Configuration Descriptor	2 22
Table 43	Interface 0 Descriptor	22
Table 44	EP1 Descriptor	22
Table 45	EP2 Descriptor	22
Table 46	EP3 Descriptor	22
Table 47	Setup Stage	23
Table 48	Data Stage	23
Table 49	Setup Stage	23

Table 50	Data Stage	23
Table 51	Setup Stage	23
Table 52	Data Stage	23
Table 53	Setup Stage	23
Table 54	Data Stage	24
Table 55	Setup Stage	24
Table 56	Data Stage	24
Table 57	Setup Stage	24
Table 58	Data Stage	24
Table 59	Setup Stage	24
Table 60	Setup Stage	24
Table 61	Setup Stage	25
Table 62	Setup Stage	25
Table 63	Registers Address Space	26
Table 64	Registers Overview	26
Table 65	Register Access Types	29
Table 66	Registers Clock Domains	30
Table 67	Reserved Registers	33
Table 68	Wakeup Frame 0 Mask Registers	51
Table 69	Wakeup Frame 1 Mask Registers	53
Table 70	Wakeup Frame 2 Mask Registers	56
Table 71	Registers Address Space	64
Table 72	Registers Overview	64
Table 73	Register Access Types	65
Table 74	Registers Clock Domains	66
Table 75	Absolute Maximum Rating	74
Table 76	Operating Condition	74
Table 77	USB Interface DC Specification	74
Table 78	EEPROM Interface DC Specification	75
Table 79	GPIO Interface DC Specification	75
Table 80	GPIO Interface DC Specification	76
Table 81	EEPROM Interface Timing	76
Table 82	EEPROM Interface	77
Table 83	EEPROM Example	78
Table 84	Dimensions for 48 Pin LQFP Package	82

1 Product Overview

1.1 Package Information

Product Name	Product Type	Package	Ordering Number
ADM8513	ADM8513-AD-T-1	P-LQFP-48-5	Q67801H 62A101 ¹⁾
ADM8513X	ADM8513X-AD-T-1	PG-LQFP-48-5	Q67801H 98A101

1) "x" stands as key to Infineon packing variants, such as "Tape&reel, drypacked" as well as for the environmentally "green" package version.

1.2 Features

Main features:

- **Industrial Standard**
 - IEEE 802.3/802.3u 10Base-T/100Base-Tx compliant.
 - Supports IEEE 802.3x flow control
 - Supports Auto-Negotiation for 10BASE-T and 100BASE-TX
 - USB specification 1.0 and 1.1 compliant
- **USB Interface**
 - USB specification 1.0 and 1.1 compliant
 - Full-Speed USB Device
 - Supports 1 USB configuration and 1 interface
 - Supports all USB standard commands
 - Supports two vendor specific commands
 - Supports USB Suspend/Resume detection logic
 - Supports 4 endpoints: 1 control endpoint with maximum 8-byte packet, 1 bulk IN endpoint with maximum 64-byte packet, 1 bulk OUT endpoint with maximum 64-byte packet and 1 interrupt IN endpoint with maximum 8-byte packet
- **MAC/PHY**
 - Integrates the PHY by using address 1
 - Supports configurable threshold for PAUSE frame.
 - Supports Auto-Negotiation
 - Provides transmit wave-shaper, receive filter, and adapter equalizer.
 - Provides MLT-3 transceiver with DC restoration for Base-Line wander.
 - Supports external transmit/receive transformer with turn ration 1:1.
- **EEPROM Interface**
 - Provides serial interface to access 93C46 EEPROM
 - Automatically load device ID, vendor ID from EEPROM after power-on reset
- **FIFO**
 - Synchronous SRAM.
 - Internal 2K-byte two port asynchronous SRAM.
- **LED Interface**
 - 2 LED operation modes
 - LED0: speed indication for 10Mbps or 100Mbps.
 - LED1: link indication.
 - LED2: full duplex indication.
- **Support Power Save Function @ USB suspend mode**

- Mode 0: Resume by remote wakeup or host when OS goes into standby
- Mode 1: Resume by host when OS goes into standby.
- **Miscellaneous**
 - Supports 6 GPIO pins
 - Provides 48-pin LQFP package
 - 3.3 V power supply with 5 V/3.3 V I/O tolerance
- **Support Driver**
 - Win98/ME/2000/XP
 - Linux driver, WinCE 3.0&4.0 driver
 - Manufacturing test utilities:
 - EEPROM Burn-in program
 - MFG testing program

2 Interface Description

2.1 Pin Assignment Diagram

Pin Diagram ADM8513/X.

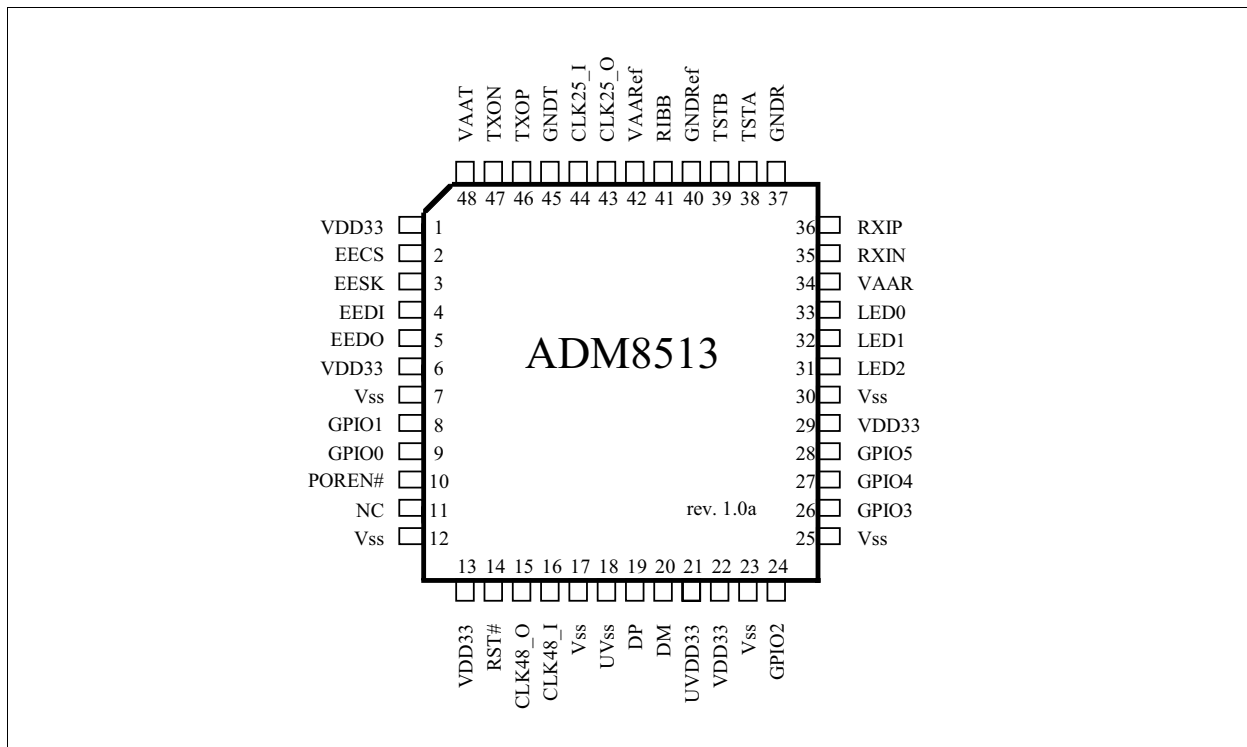
Figure 1 Pin Diagram

2.2 Pin Description by Function

Table 1 Abbreviations for Pin Type

Abbreviations	Description
I	Standard input-only pin. Digital levels.
O	Output. Digital levels.
I/O	I/O is a bidirectional input/output signal.
AI	Input. Analog levels.
AO	Output. Analog levels.
AI/O	Input or Output. Analog levels.
PWR	Power
GND	Ground
MCL	Must be connected to Low (JEDEC Standard)
MCH	Must be connected to High (JEDEC Standard)

Table 1 Abbreviations for Pin Type (cont'd)

Abbreviations	Description
NU	Not Usable (JEDEC Standard)
NC	Not Connected (JEDEC Standard)

Table 2 Abbreviations for Buffer Type

Abbreviations	Description
Z	High impedance
PU1	Pull up, 10 k Ω
PD1	Pull down, 10 k Ω
PD2	Pull down, 20 k Ω
TS	Tristate capability: The corresponding pin has 3 operational states: Low, high and high-impedance.
OD	Open Drain. The corresponding pin has 2 operational states, active low and tristate, and allows multiple devices to share as a wire-OR. An external pull-up is required to sustain the inactive state until another agent drives it, and must be provided by the central resource.
OC	Open Collector
PP	Push-Pull. The corresponding pin has 2 operational states: Active-low and active-high (identical to output with no type attribute).
OD/PP	Open-Drain or Push-Pull. The corresponding pin can be configured either as an output with the OD attribute or as an output with the PP attribute.
ST	Schmitt-Trigger characteristics
TTL	TTL characteristics

2.2.1 Host Interface

Table 3 Host Interface

Pin or Ball No.	Name	Pin Type	Buffer Type	Function
16	CLK48_I	I		Input Clock 48 MHz clock input from crystal or oscillator.
15	CLK48_O	O		Output for Crystal
14	RST#	I		External Hardware Reset Input Schmitt-trigger, internal pull high.
20	DM	I/O		USB Data Minus pin
19	DP	I/O		USB Data Plus Pin

2.2.2 Physical Interface

Table 4 Physical Interface

Pin or Ball No.	Name	Pin Type	Buffer Type	Function
86, 35	RXIP, RXIN	I		RX Input
46, 47	TXOP, TXON	O		TX Output
44	CLK25_I	I		Crystal Input 25MHz
43	CLK25_O	O		Crystal Output 25MHz
41	RIBB	I		Reference Bias Resistor, tied to external 10K(1%) resistor to ground
38, 39	TSTA, TSTB	O		Test Output Pin

2.2.3 LED Interface

Table 5 LED Interface

Pin or Ball No.	Name	Pin Type	Buffer Type	Function
33	LED0	O		LED display for 100M b/s or 10M b/s speed. Active low indicates 100Base-TX, active high indicates 10 BaseT.
32	LED1	O		LED display for link and activity status. Active low when link is established.
31	LED2	O		LED display for Full Duplex or Collision status. Active low indicates full duplex, high indicates collision in half duplex.

Note: The LED interface is EEPROM-programmable, 2 bit EEPROM control bit, Address 0B[7:6] at EEPROM, is used to select LED mode, the default setting are:

1. LED0: 100Mbps(on, drive '0') or 10Mbps(off, drive '1')
2. LED1: link (keeps on when link ok) or activity (blinks with 10Hz when Pegasus II is receiving or transmitting but not colliding)
3. LED2: full duplex (keeps on when in full duplex mode) or collision (blinks with 20Hz when colliding)
4. All LED pins will be tri-state when using external PHY (offset 81h with bit[4:2] = 001_B)

Mapping between LED action and EEPROM 0B[7:6] setting

Table 6 Mapping between LED action and EEPROM 0B[7:6] setting

EEPROM 0B[7:6]	LED	Action
0,0	LED0	10 / 100 (OFF/ON)
	LED1	LINK / ACTIVITY (ON/FLASH)
	LED2	FULL DUP / COL (ON/FLASH)
0,1	LED0	ACTIVITY when LINK (FLASH)
	LED1	LINK 10(ON)
	LED2	LINK 100(ON)

2.2.4 EEPROM Interface

Table 7 EEPROM Interface

Pin or Ball No.	Name	Pin Type	Buffer Type	Function
2	EECS	O		EEPROM Chip Select This pin enables the EEPROM during loading of the Ethernet configuration data. CMOS I/O with 5 V tolerant, 2mA
4	EEDI	O		EEPROM Data In The MAC will use this pin to serially write opcodes, addresses and data into the serial EEPROM. CMOS I/O with 5 V tolerant, 2mA
5	EEDO	I		EEPROM Data Out, internal pull low The MAC will read the contents of the EEPROM serially through this pin. Input, pull down, 5 V tolerant
3	EESK	O		EEPROM Clock After reset, the MAC if configured, will read the contents of the EEPROM using EESK, EEDO, and EEDI. This pin provides the clock for the EEPROM. CMOS I/O with 5 V tolerant, 2mA

2.2.5 Miscellaneous

Table 8 Miscellaneous

Pin or Ball No.	Name	Pin Type	Buffer Type	Function
9	GPIO5	I/O		General Purpose Input/Output Pins These pins are used as general purpose Input/Output pins and offset 0A[1] = 0 in EEPROM. Default is internal pull-low
8	GPIO4			
24	GPIO3			
26	GPIO2			
27	GPIO1			
28	GPIO0			
10	POREN#	I		Test Pins
11	NC	X		Test Pins

2.2.6 POWER USB

Table 9 Power USB

Pin or Ball No.	Name	Pin Type	Buffer Type	Function
21	UVDD 33	PWR		3.3V power supply for USB transceiver
18	UVSS	PWR		Ground for USB transceiver

2.2.7 POWER

Table 10 Power

Pin or Ball No.	Name	Pin Type	Buffer Type	Function
1, 6, 13, 22, 29	VDD 33	PWR		3.3V Power Supply.
7, 12, 23, 17, 25, 30	VSS	PWR		Ground
42	VAARef	PWR		+3.3V Power Supply for PHY.
40	GNDRed	PWR		+3.3V Power Ground for PHY
48	VAAT	PWR		+3.3V for Transmitter
45	GNDT	PWR		GND for Transmitter
34	VAAR	PWR		+3.3V for Receiver
37	GNDR	PWR		GND for Receiver

2.3 Block Diagram

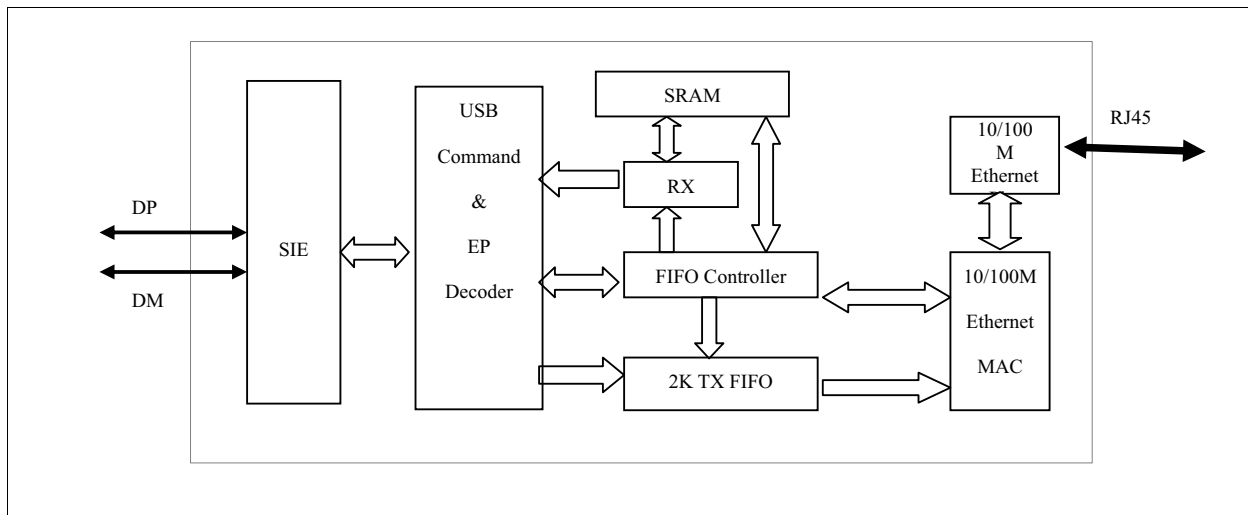

Figure 2 Block Diagram

3 Function Description

3.1 USB Interface

USB is a likely solution any time you want to use a computer to communication with devices outside the computer. The interface is suitable for one-of-kind and small-scale designs as well as mass-produced, standard peripheral. The benefits to USB are easy to use, fast and reliable data transfers, flexibility, low cost and power conservation.

3.1.1 SIE

SIE (Serial Interface Engine) is to control USB communications and check USB protocol, then transfer protocol to EP decoder. The SIE and USB transceivers, which provide the hardware interface to the USB cable, together comprise the USB engine.

3.1.2 USB Command & EP Decoder

The detail description is in "USB Command".

3.2 FIFO Controller

FIFO Controller in receive path is in charge of:

- Stores received Ethernet packets to SRAM and multiple packets can be stored to SRAM. If more than maximum packet counts are received or total packet size is more than the size of SRAM, the subsequent coming Ethernet packet will be discarded.
- FIFO controller will load data from SRAM to internal RX FIFO then inform EP Decoder that 64-byte data or a packet is ready in RX FIFO. Before FIFO controller informs about this, any USB access to bulk IN endpoint will return NAK. This is to maintain the data transfer on the USB bus via bulk IN transfer which is continuous, thus a 64-byte internal RX FIFO is needed.
- If an Ethernet packet is being received and loading into SRAM while FIFO Controller is moving data from SRAM to internal RX FIFO, writing the Ethernet packet to SRAM will get the higher priority.

3.3 TX FIFO and RX FIFO

RX FIFO is a one-port 64-byte FIFO and TX FIFO is a two-port 2K-byte FIFO.

3.4 10/100M Ethernet PHY

The Ethernet PHY is compliant to IEEE 802.3u 100BASE-TX and IEEE802.3 10BASE-T. It provides the whole physical layer functions for both 10M and 100M Ethernet speed.

4 USB Device Endpoint Operation

4.1 Endpoint 0

Endpoint 0 is in charge of response to standard USB commands and vendor specific commands. Internal register settings are also via this endpoint. The response to each command is described in section 6.

4.2 Endpoint 1 Bulk IN

Endpoint 1 is in charge of sending the received Ethernet packet to USB host. An Ethernet packet will be split to multiple 64 bytes USB packets on USB. The end of the Ethernet packet is indicated by less than 64-byte or 0 length data transfer in this pipe. The Ethernet received status is optionally reported at the end of the packet.

While accessing to this endpoint, if RXFIFO is either full or any packet is inside, the data in RXFIFO is returned in USB data stage. If ACK is received from USB host, data in RXFIFO is flushed. If no response or NAK is received from USB host, the content in RXFIFO will be re-transmitted. If RXFIFO isn't ready for transmission, NAK is returned to USB host.

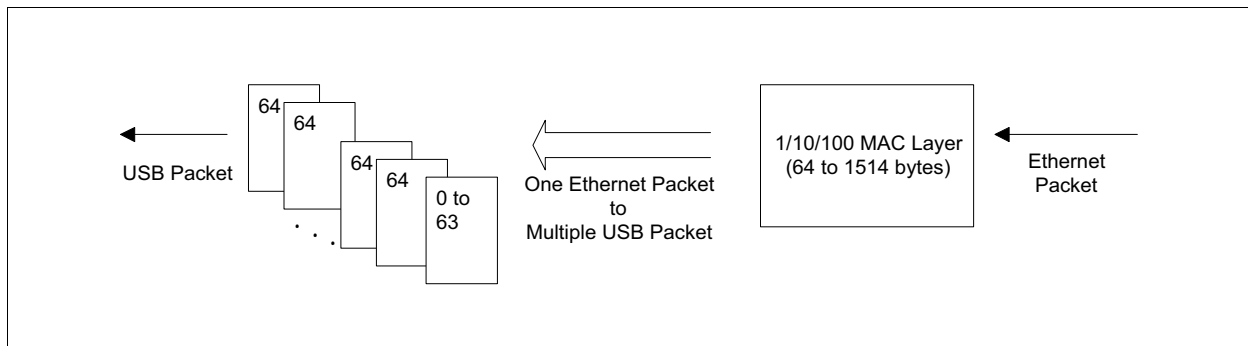

Figure 3 Packet Form when Receive

The Received Status is Reported as Follows:

Table 11 USB Received Status

Offset	Bit	Field	Description
Offset0	7-0	rx_bytecnt_lo	The received byte count[7:0].
Offset1	3-0	rx_bytecnt_hi	The received byte count[11:8].
	7-4	reserved	
Offset2	0	multicast_frame	Indicates received a multicast frame.
	1	long_pkt	Indicates received packet length > 1518 bytes.
	2	runt_pkt	Indicates received packet length < 64 bytes.
	3	crc_err	Indicates CRC check error.
	4	dribble_bit	Indicates packet length is not integer multiple of 8-bit.
	7-5	reserved	
Offset3	7-0	reserved	

4.2.1 Endpoint 2 Bulk OUT

Endpoint 2 is in charge of sending the USB packet to Ethernet. An Ethernet packet is concatenated by multiple 64 bytes USB packets on USB. The first two bytes in every first concatenated USB packet indicate the length of the Ethernet packet. The end of the Ethernet packet is indicated by less than 64-byte or 0 length data transfer in this pipe. The Ethernet transmit status is reported in transmit status register.

When accessing to this endpoint, data in USB data stage is transferred to TXFIFO, if TXFIFO is free and ACK is returned. If TXFIFO isn't free, NAK is returned.

Table 12 USB Packet Format

Field	1st Byte in 1st USB Packet	2nd Byte in 1st USB Packet	The Following Packets
Content	len[7:0]: Low byte Ethernet packet length	{reserved[4:0], len[10:8]}	Ethernet packet

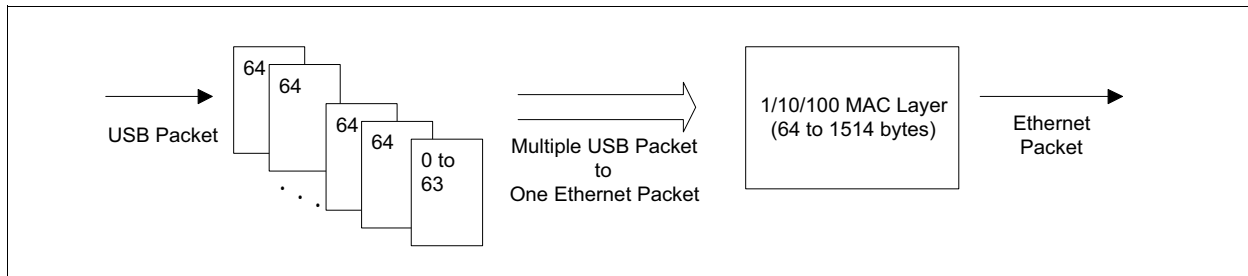
Figure 4 Packet Form when Transmit

4.2.2 Endpoint 3 Interrupt IN

Endpoint 3 is in charge of returning the current Ethernet transfer status every polling interval. When accessing to this endpoint, 8 bytes data is returned to USB host. The 8-byte packet contains

Table 13 Interrupt Packet Form

Offset0	Offset1	Offset2	Offset3	Offset4
tx_status(Reg2B _H)	tx_status(Reg2C _H)	rx_status(Reg2D _H)	rx_lostpkt(Reg2E _H)	rx_lostpkt(Reg2F _H)

Table 14 Interrupt Packet Form

Offset5	Offset6(1B)	Offset7(1B)
wakeup_status(Reg7A _H)	Packet number in RX FIFO (Reg82 _H)	7'b00, length error

5 USB Commands

5.1 USB Command

5.1.1 Get Register (Vendor Specific) Single/Burst Read

Table 15 Setup Stage

bmReq	bReq	wValue(2B)	wIndexLow(1B)	wIndexHigh(1B)	wLength L(1B)	wLength H(1B)
C0	F0	0	RegIndex[7:0]	00	Length Low	Length High

Table 16 Data Stage

Offset0(1B)	Offset1(1B)	Offset2(1B)
{RegIndex}	{RegIndex+1}	{RegIndex+2}

The returned total number of registers depends on the length field.

5.1.2 Set Register (Vendor Specific) Burst Write

Table 17 Setup Stage

bmReq	bReq	wValue(2B)	wIndexLow(1B)	wIndexHigh(1B)	wLength L(1B)	wLength H(1B)
40	F1	0	RegIndex[7:0]	00	Length Low	Length High

Table 18 Data Stage

Offset0(1B)	Offset1(1B)	Offset2(1B)	Offset3(1B)
{RegIndex}	{RegIndex+1}	{RegIndex+2}	{RegIndex+3}

Ex. Write 44 to RegIndex = 05_H, the transfer will be

Table 19 Setup Stage

bmReq	bReq	wValue L(1B)	wValue H(1B)	wIndexLow (1B)	wIndexHigh (1B)	wLength L(1B)	wLength H(1B)
40	F1	44	00	05	00	01	00

If wLength > 1, more than 1 register is accessed (burst write) and mask is not supported => DataStage for 8-byte OUT transfer appears

Ex. Burst write 20 registers from RegIndex = 07_H and data from 01_D to 20_D

- Setup Stage

Table 20 Setup Stage

bmReq	bReq	wValue(2B)	wIndexLow(1B)	wIndexHigh(1B)	wLength L(1B)	wLength H(1B)
40	F1	0000	07	00	14	00

- Data Stage

Table 21 1st OUT Transfer

Offset0(1B)	Offset1(1B)	Offset2(1B)	Offset3(1B)	Offset4(1B)	Offset5(1B)	Offset6(1B)	Offset7(1B)
01	02	03	04	05	06	07	08

Table 22 2nd OUT Transfer

Offset0(1B)	Offset1(1B)	Offset2(1B)	Offset3(1B)	Offset4(1B)	Offset5(1B)	Offset6(1B)	Offset7(1B)
09	0A	0B	0C	0D	0E	0F	10

Table 23 3rd OUT Transfer

Offset0(1B)	Offset1(1B)	Offset2(1B)
11	12	13

5.1.3 Get Status (Device)

Table 24 Setup Stage

bmReq	bReq	wValue(2B)	wIndex(2B)	wLength L(1B)	wLength H(1B)
80	0	0	0	2	0

Table 25 Data Stage

D[15:2]	D[1]: Remote Wakeup	D[0]: Self Powered
0	Register of remote_wakeup	1

5.1.4 Get Status (Interface)

Table 26 Setup Stage

bmReq	bReq	wValue(2B)	wIndex(2B)	wLength L(1B)	wLength H(1B)
81	0	0	0	2	0

Table 27 Data Stage

D[15:0]
0

5.1.5 Get Status (EP0)

Table 28 Setup Stage

bmReq	bReq	wValue(2B)	wIndex L(1B)	wIndex H(1B)	wLength L(1B)	wLength H(1B)
82	0	0	80 or 00	00	2	0

Table 29 Data Stage

D[15:1]	D[0]: Halt
0	Register of ep0_halt

5.1.6 Get Status (EP1) Bulk In

Table 30 Setup Stage

bmReq	bReq	wValue(2B)	wIndex L(1B)	wIndex H(1B)	wLength L(1B)	wLength H(1B)
82	0	0	81	00	2	0

Table 31 Data Stage

D[15:1]	D[0]: Halt
0	Register of ep1_halt

5.1.7 Get Status (EP2) Bulk OUT

Table 32 Setup Stage

bmReq	bReq	wValue(2B)	wIndex L(1B)	wIndex H(1B)	wLength L(1B)	wLength H(1B)
82	0	0	02	00	2	0

Table 33 Data Stage

D[15:1]	D[0]: Halt
0	register of ep2_halt

5.1.8 Get Status (EP3) Interrupt IN

Table 34 Setup Stage

bmReq	bReq	wValue(2B)	wIndex L(1B)	wIndex H(1B)	wLength L(1B)	wLength H(1B)
82	0	0	83	00	2	0

Table 35 Data Stage

D[15:1]	D[0]: Halt
0	register of ep3_halt

5.1.9 Get Descriptor (Device) Total 18-byte

Table 36 Setup Stage

bmReq	bReq	wValue L(1B)	wValue H(1B)	wIndex(2B)	wLength L(1B)	wLength H(1B)
80	6	01	00	0	Length low	Length high

Table 37 Data Stage: wLength Field Specifies the Total byte Count to Return 1

Offset 0	Offset 1 (type)	Offset 2 (USB release no. L)	Offset 3 (USB release no. H)	Offset 4 (Class code)	Offset 5 (Sub Class Code)	Offset 6 (Protocol)	Offset 7 (EP0 MaxPktSize)
12(1 _B)	01(1 _B)	10(1 _B)	01(1 _B)	FF(1 _B)	00(1 _B)	ff(1 _B)	8(1 _B)

Table 38 Data Stage: wLength Field Specifies the Total byte Count to Return 2

Offset 8 (vendor ID) Low	Offset 9 (vendor ID) High	Offset 10 (productID) Low	Offset 11 (productID) High	Offset 12 (releaseID) Low
(1 _B)	(1 _B)	(1 _B)	(1 _B)	01(1 _B)

Table 39 Data Stage: wLength Field Specifies the Total byte Count to Return 3

Offset 13 (releaseID) High	Offset 14 (manufacture)	Offset 15 (Product)	Offset 16 (serial no.)	Offset 17 (no. of config)
01(1 _B)	01(1 _B)	02(1 _B)	03(1 _B)	01(1 _B)

5.1.10 Get Descriptor (Configuration) Total 39-byte

Table 40 Setup Stage

BmReq	bReq	wValue L(1B)	wValue H(1B)	wIndex(2B)	wLength L(1B)	wLength H(1B)
80	6	02	00	0	Length low	Length high

- Data Stage

Table 41 Configuration Descriptor 1

Offset 0 (Length)	Offset 1 (DscrType)	Offset 2 (TotalLength) Low	Offset 3 (TotalLength) High	Offset 4 (NumInterface)
09(1 _B)	02(1 _B)	27(1 _B)	00(1 _B)	01(1 _B)

Table 42 Configuration Descriptor 2

Offset 5 (ConfigValue)	Offset 6 (StringIndex)	Offset 7 (Attribute)	Offset 8 (MaxPower)
00(1 _B)	00(1 _B)	E0(1 _B)	max_pwr(1 _B)

Table 43 Interface 0 Descriptor

Offset 0 (Length)	Offset 1 (DscrType)	Offset 2 (Interface Num)	Offset 3 (AltInterface)	Offset 4 (NumEP)	Offset 5 (IntfClass)	Offset 6 (IntfSubClass)	Offset 7 (IntfProtocol)	Offset 8 (StringIndex)
09(1 _B)	04(1 _B)	00(1 _B)	00(1 _B)	03(1 _B)	FF(1 _B)	E0(1 _B)	FF(1 _B)	00(1 _B)

Table 44 EP1 Descriptor

Offset 0 (Length)	Offset 1 (DscrType)	Offset 2 (EPAddr)	Offset 3 (Attribute)	Offset 4 (MaxPktSize) Low	Offset 5 (MaxPktSize) High	Offset 6 (Interval)
07(1 _B)	05(1 _B)	81(1 _B)	02(1 _B) bulk	64(1 _B)	00(1 _B)	00(1 _B)

Table 45 EP2 Descriptor

Offset 0 (Length)	Offset 1 (DscrType)	Offset 2 (EPAddr)	Offset 3 (Attribute)	Offset 4 (MaxPktSize) Low	Offset 4 (MaxPktSize) High	Offset 6 (Interval)
07(1 _B)	05(1 _B)	02(1 _B)	02(1 _B) bulk	64(1 _B)	00(1 _B)	00(1 _B)

Table 46 EP3 Descriptor

Offset 0 (Length)	Offset 1 (DscrType)	Offset 2 (EPAddr)	Offset 3 (Attribute)	Offset 4 (MaxPktSize) Low	Offset 5 (MaxPktSize) High	Offset 6 (Interval)
07(1 _B)	05(1 _B)	83(1 _B)	03(1 _B) interrupt	08(1 _B)	00(1 _B)	ep3_interval(1 _B)

5.1.11 Get Descriptor (String) Index 0, LanguageID Code

Table 47 Setup Stage

BmReq	bReq	wValue L(1B)	wValue H(1B)	wIndex(2B)	wLength Low(1B)	wLength High(1B)
80	06	00	03	0000	Length Low	Length High

Table 48 Data Stage

Offset0 (Length)	Offset1 (DscrType)	Offset2 (LanguageID) L	Offset3 (LanguageID) H
04(1 _B)	03(1 _B)	09(1 _B)	04(1 _B)

5.1.12 Get Descriptor (String) Index 1, Manufacture

Table 49 Setup Stage

BmReq	bReq	wValue L(1B)	wValue H(1B)	wIndex (2B)	wLength Low(1B)	wLength High(1B)
80	06	01	03	0904	Length Low	Length High

Table 50 Data Stage

Offset0 (Length)	Offset1 (DscrType)	
length(1B)	03(1B)	String

5.1.13 Get Descriptor (String) Index 2, Product
Table 51 Setup Stage

BmReq	bReq	wValue L(1B)	wValue H(1B)	wIndex (2B)	wLength Low(1B)	wLength High(1B)
80	06	02	03	0904	Length Low	Length High

Table 52 Data Stage

Offset 0 (Length)	Offset 1 (DscrType)	
length(1 _B)	03(1 _B)	String

5.1.14 Get Descriptor (String) Index 3, Serial No.
Table 53 Setup Stage

BmReq	bReq	wValue L(1B)	wValue H(1B)	wIndex (2B)	wLength Low(1B)	wLength High(1B)
80	06	03	03	0904	Length Low	Length High

Table 54 Data Stage

Offset 0 (Length)	Offset 1 (DscrType)	
Length(1 _B)	03(1 _B)	String

5.1.15 Get Configuration
Table 55 Setup Stage

BmReq	bReq	wValue(2B)	wIndex(2B)	wLength Low(1B)	wLength High(1B)
80	08	0	0	1	0

Table 56 Data Stage

Offset 0 (ConfigValue)(1B)	

5.1.16 Get Interface
Table 57 Setup Stage

BmReq	bReq	wValue(2B)	wIndex(2B)	wLength Low(1B)	wLength High(1B)
81	10	0	0	1	0

Table 58 Data Stage
Offset0 (AltIntf) (1B)

00

5.1.17 Clear Feature (Device) Remote Wakeup
Table 59 Setup Stage

BmReq	bReq	wValue L(1B)	WValue H(1B)	wIndex(2B)	wLength(2B)
00	01	01	00	0	0

5.1.18 Set Feature (Device) Remote Wakeup
Table 60 Setup Stage

BmReq	bReq	wValue L(1B)	WValue H(1B)	wIndex(2B)	wLength(2B)
00	03	01	00	0	0

5.1.19 Clear Feature (EP 0, 1, 2, 3) Halt
Table 61 Setup Stage

BmReq	bReq	wValue(2B)	WIndex L(1B)	wIndex L(2B)	WLength(2B)
02	03	0000	EP no	00	0

5.1.20 Set Feature (EP 0, 1, 2, 3) Halt
Table 62 Setup Stage

BmReq	bReq	wValue(2B)	WIndex H(1B)	wIndex H(2B)	WLength(2B)
02	03	0000	EP no	00	0

6 Registers Description

6.1 System Registers

Table 63 Registers Address Space

Module	Base Address	End Address	Note
System Registers	0000 0000 _H	0000 0081 _H	

Table 64 Registers Overview

Register Short Name	Register Long Name	Offset Address	Page Number
Res30_Res155	Reserved 30~Reserved 155	82~FF _H	34
EC0	Ethernet Control 0	00 _H	30
EC1	Ethernet Control 1	01 _H	31
EC2	Ethernet Control 2	02 _H	32
Res0	Reserved 0	03 _H	33
Res1	Reserved 1	04 _H	33
Res2	Reserved 2	05 _H	33
Res3	Reserved 3	06 _H	33
Res4	Reserved 4	07 _H	33
MA0	Multicast Address 0	08 _H	34
MA1	Multicast Address 1	09 _H	34
MA2	Multicast Address 2	0A _H	35
MA3	Multicast Address 3	0B _H	35
MA4	Multicast Address 4	0C _H	36
MA5	Multicast Address 5	0D _H	36
MA6	Multicast Address 6	0E _H	37
MA7	Multicast Address 7	0F _H	37
EID0	Ethernet ID 0	10 _H	38
EID1	Ethernet ID 1	11 _H	38
EID2	Ethernet ID 2	12 _H	39
EID3	Ethernet ID 3	13 _H	39
EID4	Ethernet ID 4	14 _H	40
EID5	Ethernet ID 5	15 _H	40
Res5	Reserved 5	16 _H	33
Res6	Reserved 6	17 _H	33
PT	Pause Timer	18 _H	41
RPNBFC	Receive Packet Number Based Flow Control	1A _H	41
ORFBFC	Occupied Receive FIFO Based Flow Control	1B _H	42
EP1C	EP1 Control	1C _H	42
Res7	Reserved 7	1C _H	33

Registers Description
Table 64 Registers Overview (cont'd)

Register Short Name	Register Long Name	Offset Address	Page Number
Res8	Reserved 8	1D _H	33
Res9	Reserved 9	1E _H	33
Res10	Reserved 10	1F _H	33
EEPROMO	EEPROM Offset	20 _H	43
EEPROMDL	EEPROM Data Low	21 _H	43
EEPROMDH	EEPROM Data High	22 _H	43
EEPROMAC	EEPROM Access Control	23 _H	45
Res11	Reserved 11	24 _H	33
PHYA	PHY Address	25 _H	45
PHYDL	PHY Data Low	26 _H	46
PHYDH	PHY Data High	27 _H	46
PHYAC	PHY Access Control	28 _H	47
Res12	Reserved 12	29 _H	33
USBBS	USB Bus Status	2A _H	47
TS1	Transmit Status 1	2B _H	47
TS2	Transmit Status 2	2C _H	49
RS	Receive Status	2D _H	49
RLPCH	Receive Lost Packet Count High	2E _H	50
RLPCL	Receive Lost Packet Count Low	2F _H	50
WUF0M_0	Wakeup Frame 0 Mask	30 _H	50
WUF0M_1	Wakeup Frame 0 Mask 1	31 _H	51
WUF0M_2	Wakeup Frame 0 Mask 2	32 _H	51
WUF0M_3	Wakeup Frame 0 Mask 3	33 _H	51
WUF0M_4	Wakeup Frame 0 Mask 4	34 _H	51
WUF0M_5	Wakeup Frame 0 Mask 5	35 _H	51
WUF0M_6	Wakeup Frame 0 Mask 6	36 _H	51
WUF0M_7	Wakeup Frame 0 Mask 7	37 _H	51
WUF0M_8	Wakeup Frame 0 Mask 8	38 _H	51
WUF0M_9	Wakeup Frame 0 Mask 9	39 _H	51
WUF0M_10	Wakeup Frame 0 Mask 10	3A _H	51
WUF0M_11	Wakeup Frame 0 Mask 11	3B _H	51
WUF0M_12	Wakeup Frame 0 Mask 12	3C _H	51
WUF0M_13	Wakeup Frame 0 Mask 13	3D _H	51
WUF0M_14	Wakeup Frame 0 Mask 14	3E _H	51
WUF0M_15	Wakeup Frame 0 Mask 15	3F _H	51
WUF0O_0	Wakeup Frame 0 Offset	40 _H	51
WUF0CRCL	Wakeup Frame 0 CRC Low	41 _H	52
WUF0CRCH	Wakeup Frame 0 CRC High	42 _H	52
Res13	Reserved 13	43 _H	33
Res14	Reserved 14	44 _H	33
Res15	Reserved 15	45 _H	33

Registers Description
Table 64 Registers Overview (cont'd)

Register Short Name	Register Long Name	Offset Address	Page Number
Res16	Reserved 16	46 _H	33
Res17	Reserved 17	47 _H	33
WUF1M_0	Wakeup Frame 1 Mask	48 _H	53
WUF1M_1	Wakeup Frame 1 Mask 1	49 _H	53
WUF1M_2	Wakeup Frame 1 Mask 2	4A _H	53
WUF1M_3	Wakeup Frame 1 Mask 3	4B _H	53
WUF1M_4	Wakeup Frame 1 Mask 4	4C _H	53
WUF1M_5	Wakeup Frame 1 Mask 5	4D _H	53
WUF1M_6	Wakeup Frame 1 Mask 6	4E _H	53
WUF1M_7	Wakeup Frame 1 Mask 7	4F _H	53
WUF1M_8	Wakeup Frame 1 Mask 8	50 _H	53
WUF1M_9	Wakeup Frame 1 Mask 9	51 _H	53
WUF1M_10	Wakeup Frame 1 Mask 10	52 _H	53
WUF1M_12	Wakeup Frame 1 Mask 12	54 _H	53
WUF1M_13	Wakeup Frame 1 Mask 13	55 _H	53
WUF1M_11	Wakeup Frame 1 Mask 11	56 _H	53
WUF1M_14	Wakeup Frame 1 Mask 14	56 _H	53
WUF1M_15	Wakeup Frame 1 Mask 15	57 _H	53
WUF1O	Wakeup Frame 1 Offset	58 _H	53
WUF1CRCL	Wakeup Frame 1 CRC Low	59 _H	55
WUF1CRCH	Wakeup Frame 1 CRC High	5A _H	55
Res18	Reserved 18	5B _H	33
Res19	Reserved 19	5C _H	33
Res20	Reserved 20	5D _H	33
Res21	Reserved 21	5E _H	33
Res22	Reserved 22	5F _H	33
WUF2M	Wakeup Frame 2 Mask	60 _H	56
WUF2M_1	Wakeup Frame 2 Mask 1	61 _H	56
WUF2M_2	Wakeup Frame 2 Mask 2	62 _H	56
WUF2M_3	Wakeup Frame 2 Mask 3	63 _H	56
WUF2M_4	Wakeup Frame 2 Mask 4	64 _H	56
WUF2M_5	Wakeup Frame 2 Mask 5	65 _H	56
WUF2M_6	Wakeup Frame 2 Mask 6	66 _H	56
WUF2M_7	Wakeup Frame 2 Mask 7	67 _H	56
WUF2M_8	Wakeup Frame 2 Mask 8	68 _H	56
WUF2M_9	Wakeup Frame 2 Mask 9	69 _H	56
WUF2M_10	Wakeup Frame 2 Mask 10	6A _H	56
WUF2M_11	Wakeup Frame 2 Mask 11	6B _H	56
WUF2M_12	Wakeup Frame 2 Mask 12	6C _H	56
WUF2M_13	Wakeup Frame 2 Mask 13	6D _H	56
WUF2M_14	Wakeup Frame 2 Mask 14	6E _H	56

Registers Description
Table 64 Registers Overview (cont'd)

Register Short Name	Register Long Name	Offset Address	Page Number
WUF2M_15	Wakeup Frame 2 Mask 15	6F _H	56
WUF2O	Wakeup Frame 2 Offset	70 _H	56
WUF2CRCL	Wakeup Frame 2 CRC Low	71 _H	58
WUF2CRCH	Wakeup Frame 2 CRC High	72 _H	58
Res23	Reserved 23	73 _H	33
Res24	Reserved 24	74 _H	33
Res25	Reserved 25	75 _H	33
Res26	Reserved 26	76 _H	34
Res27	Reserved 27	77 _H	34
WUC	Wakeup Control	78 _H	59
Res28	Reserved 28	79 _H	34
WUS	Wakeup Status	7A _H	60
IPHYC	Internal PHY Control	7B _H	60
GPIO54C	GPIO[5:4] Control	7C _H	61
Res29	Reserved 29	7D _H	34
GPIO10C	GPIO[1:0] Control	7E _H	62
GPIO32C	GPIO[3:2] Control	7F _H	63
Test	TEST	80 _H	64
TM	Test Mode	81 _H	64

The register is addressed wordwise.

Table 65 Register Access Types

Mode	Symbol	Description HW	Description SW
read/write	rw	Register is used as input for the HW	Register is readable and writable by SW
read	r	Register is written by HW (register between input and output -> one cycle delay)	Value written by software is ignored by hardware; that is, software may write any value to this field without affecting hardware behavior (= Target for development.)
Read only	ro	Register is set by HW (register between input and output -> one cycle delay)	SW can only read this register
Read virtual	rv	Physically, there is no new register, the input of the signal is connected directly to the address multiplexer.	SW can only read this register
Latch high, self clearing	lhsc	Latch high signal at high level, clear on read	SW can read the register
Latch low, self clearing	llsc	Latch high signal at low-level, clear on read	SW can read the register
Latch high, mask clearing	lhmk	Latch high signal at high level, register cleared with written mask	SW can read the register, with write mask the register can be cleared (1 clears)
Latch low, mask clearing	llmk	Latch high signal at low-level, register cleared on read	SW can read the register, with write mask the register can be cleared (1 clears)

Registers Description
Table 65 Register Access Types (cont'd)

Mode	Symbol	Description HW	Description SW
Interrupt high, self clearing	ihsc	Differentiates the input signal (low->high) register cleared on read	SW can read the register
Interrupt low, self clearing	iisc	Differentiates the input signal (high->low) register cleared on read	SW can read the register
Interrupt high, mask clearing	ihmk	Differentiates the input signal (high->low) register cleared with written mask	SW can read the register, with write mask the register can be cleared
Interrupt low, mask clearing	ilmk	Differentiates the input signal (low->high) register cleared with written mask	SW can read the register, with write mask the register can be cleared
Interrupt enable register	ien	Enables the interrupt source for interrupt generation	SW can read and write this register
latch_on_reset	lor	rw register, value is latched after first clock cycle after reset	Register is readable and writable by SW
Read/write self clearing	rWSC	Register is used as input for the hw, the register will be cleared due to a HW mechanism.	Writing to the register generates a strobe signal for the HW (1 pdi clock cycle) Register is readable and writable by SW.

Table 66 Registers Clock DomainsRegisters Clock Domains

Clock Short Name	Description

6.1.1 System Registers
Ethernet Control 0

EC0 **Offset**
Ethernet Control 0 **00_H** **Reset Value**
09_H

7	6	5	4	3	2	1	0
TXE	RXE	RXFCE	WOE	RXSA	SBO	RXMA	RXCS
rw	rw	rw	rw	rw	rw	rw	rw

Field	Bits	Type	Description
TXE	7	rw	Ethernet Transmission Enable
RXE	6	rw	Ethernet Receive Enable
RXFCE	5	rw	Receive Pause Frame Enable
WOE	4	rw	Wake-on-LAN Mode Enable
RXSA	3	rw	Status Append at the End of Received Packet Enable

Registers Description

Field	Bits	Type	Description
SBO	2	rw	Stop Back Off 0 _B CNOT , Back-off counter isn't affected by carrier 1 _B CST , Back-off counter stops when carrier is active and resumes when carrier drops
RXMA	1	rw	Receive All Multicast Packet
RXCS	0	rw	Include CRC in Receive Packet

Ethernet Control 1

EC1 **Offset** **Reset Value**
Ethernet Control 1 **01_H** **00_H**

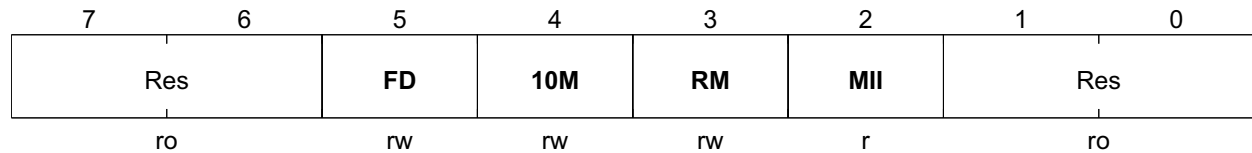

Field	Bits	Type	Description
Res	7:6	ro	Reserved
FD	5	rw	Full Duplex 0 _B HDM , Half-duplex mode 1 _B FDM , Full-duplex mode
10M	4	rw	10mode 0 _B 10Base , 10Base-T mode 1 _B 100Base , 100Base-T mode
RM	3	rw	Reset MAC After write 1, HW will clear this bit after MAC reset.
MII	2	r	MII Mode 0 _B MIIM , MII mode
Res	1:0	ro	Reserved

Ethernet Control 2

EC2 **Offset** **Reset Value**
Ethernet Control 2 **02_H** **00_H**

	7	6	5	4	3	2	1	0
	MEPL	Res	LEEPSRS	EEPRW	LB	PROM	RXBP	EP3RC
	rw	ro	rw	rw	rw	rw	rw	rw

Field	Bits	Type	Description
MEPL	7	rw	Max Ethernet Packet Length 0 _B 1528B , 1528 bytes 1 _B 1638B , 1638 bytes, Default is 0
Res	6	ro	Reserved
LEEPSRS	5	rw	Load EEPROM Start When this bit is written with 1, HW will start to load EEPROM.
EEPRW	4	rw	EEPROM Write Enable/disable 0 _B WEDC , EEPROM writes enable/disable command 1 _B WC , EEPROM writes command
LB	3	rw	MAC Loop Back Mode Enable
PROM	2	rw	Promiscuous 0 _B RPP , Receives packets which pass the address filter 1 _B RAP , Receives any packet
RXBP	1	rw	Receive Bad Packets 0 _B FABP , Filters all bad packet 1 _B RBPP , Receives bad packets which pass the address filter
EP3RC	0	rw	EP3 Read Cleared 0 _B AEP3 , Access EP3, no effect to those registers. 1 _B OEP3 , Once EP3 is accessed, those registers (2B-2F, 7A) will be cleared.

Registers Description
Reserved 0

Res0 **Offset** **Reset Value**
Reserved 0 **03_H** **00_H**

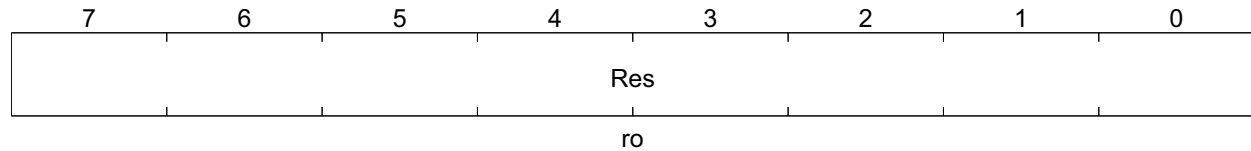

Field	Bits	Type	Description
Res	7:0	ro	Reserved

Similar Registers
Table 67 Reserved Registers

Register Short Name	Register Long Name	Offset Address	Page Number
Res1	Reserved 1	04 _H	
Res2	Reserved 2	05 _H	
Res3	Reserved 3	06 _H	
Res4	Reserved 4	07 _H	
Res5	Reserved 5	16 _H	
Res6	Reserved 6	17 _H	
Res7	Reserved 7	1C _H	
Res8	Reserved 8	1D _H	
Res9	Reserved 9	1E _H	
Res10	Reserved 10	1F _H	
Res11	Reserved 11	24 _H	
Res12	Reserved 12	29 _H	
Res13	Reserved 13	43 _H	
Res14	Reserved 14	44 _H	
Res15	Reserved 15	45 _H	
Res16	Reserved 16	46 _H	
Res17	Reserved 17	47 _H	
Res18	Reserved 18	5B _H	
Res19	Reserved 19	5C _H	
Res20	Reserved 20	5D _H	
Res21	Reserved 21	5E _H	
Res22	Reserved 22	5F _H	
Res23	Reserved 23	73 _H	
Res24	Reserved 24	74 _H	
Res25	Reserved 25	75 _H	

Registers Description
Table 67 Reserved Registers (cont'd)

Register Short Name	Register Long Name	Offset Address	Page Number
Res26	Reserved 26	76 _H	
Res27	Reserved 27	77 _H	
Res28	Reserved 28	79 _H	
Res29	Reserved 29	7D _H	
Res30_Res155	Reserved 30~Reserved 155	82~FF _H	

Multicast Address 0

MA0 **Offset**
Multicast Address 0 **08_H** **Reset Value**
00_H

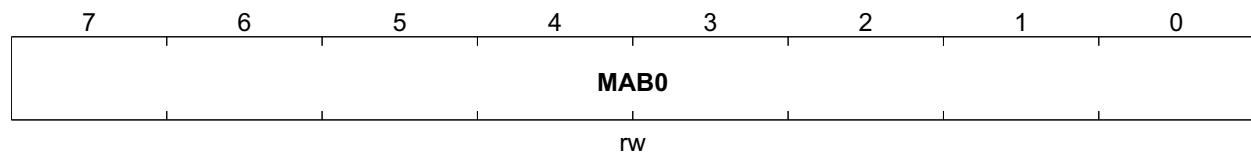

Field	Bits	Type	Description
MAB0	7:0	rw	Multicast 0 Multicast address byte [7:0]

Multicast Address 1

MA1 **Offset**
Multicast Address 1 **09_H** **Reset Value**
00_H

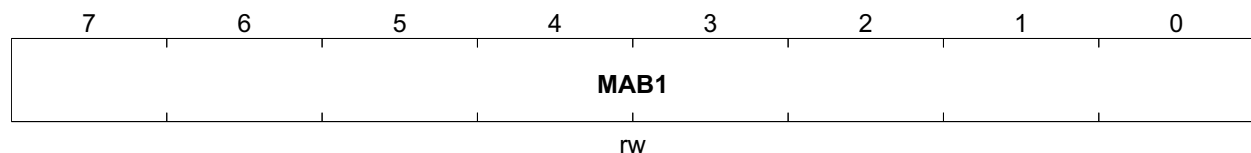

Field	Bits	Type	Description
MAB1	7:0	rw	Multicast 1 Multicast address byte [15:8]

Multicast Address 2

MA2 **Offset** **Reset Value**
Multicast Address 2 **0A_H** **00_H**

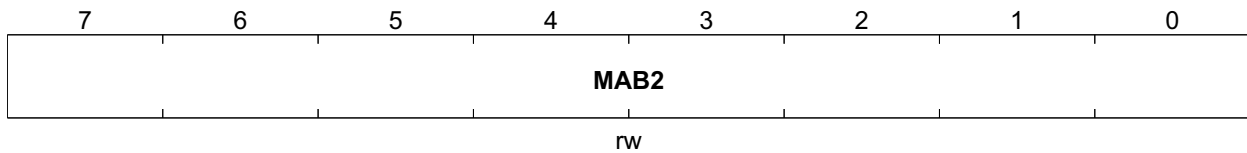

Field	Bits	Type	Description
MAB2	7:0	rw	Multicast 2 Multicast address byte [23:16]

Multicast Address 3

MA3 **Offset** **Reset Value**
Multicast Address 3 **0B_H** **00_H**

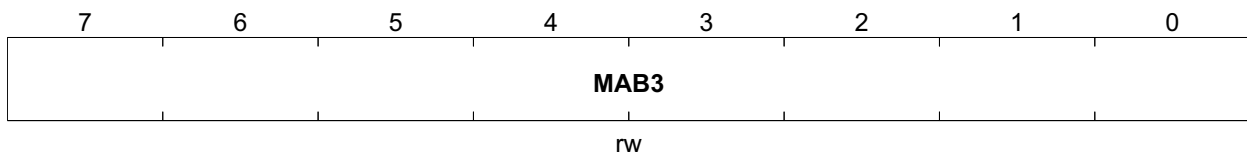

Field	Bits	Type	Description
MAB3	7:0	rw	Multicast 3 Multicast address byte [31:24]

Multicast Address 4

MA4	Offset	Reset Value
Multicast Address 4	0C_H	00_H

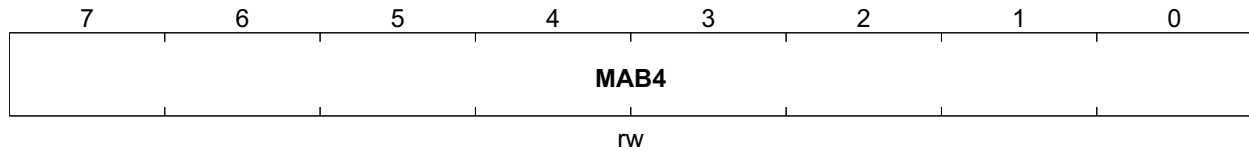

Field	Bits	Type	Description
MAB4	7:0	rw	Multicast 4 Multicast address byte [39:32]

Multicast Address 5

MA5	Offset	Reset Value
Multicast Address 5	0D_H	00_H

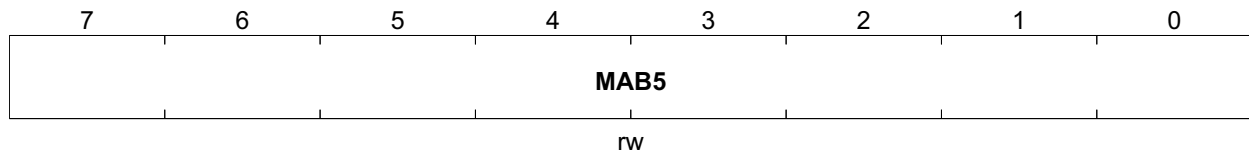

Field	Bits	Type	Description
MAB5	7:0	rw	Multicast 5 Multicast address byte [47:40]

Multicast Address 6

MA6	Offset	Reset Value
Multicast Address 6	0E _H	00 _H

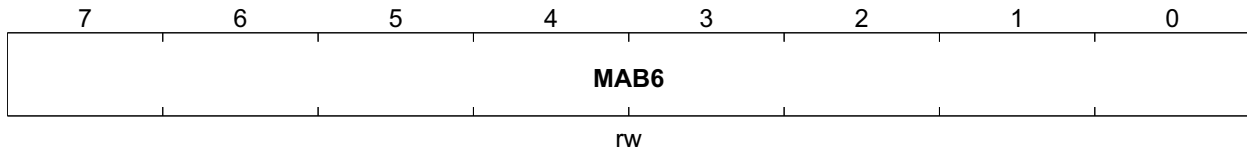

Field	Bits	Type	Description
MAB6	7:0	rw	Multicast 6 Multicast address byte [55:48]

Multicast Address 7

MA7	Offset	Reset Value
Multicast Address 7	0F _H	00 _H

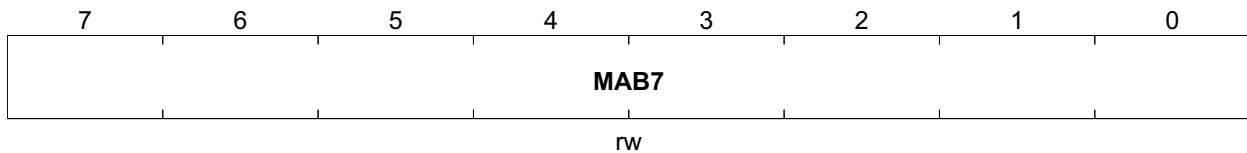

Field	Bits	Type	Description
MAB7	7:0	rw	Multicast 7 Multicast address byte [63:56]

Ethernet ID 0

EID0	Offset	Reset Value
Ethernet ID 0	10 _H	00 _H

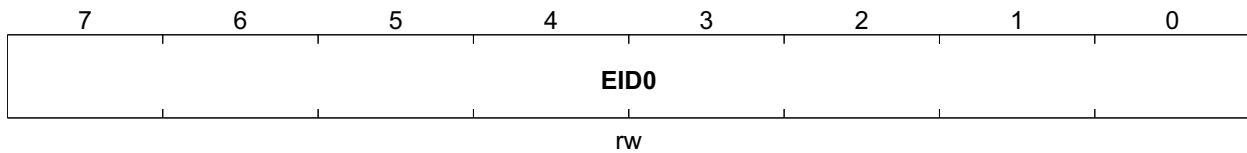

Field	Bits	Type	Description
EID0	7:0	rw	Ethernet ID 0 The 1st byte of Ethernet ID is automatically loaded from EEPROM after HW reset.

Ethernet ID 1

EID1	Offset	Reset Value
Ethernet ID 1	11 _H	00 _H

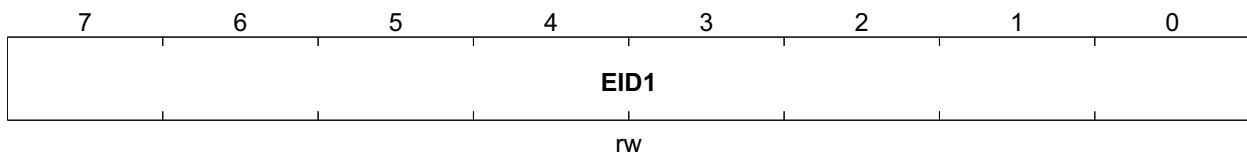

Field	Bits	Type	Description
EID1	7:0	rw	Ethernet ID 1 The 2nd byte of Ethernet ID.

Ethernet ID 2

EID2	Offset	Reset Value
Ethernet ID 2	12 _H	00 _H

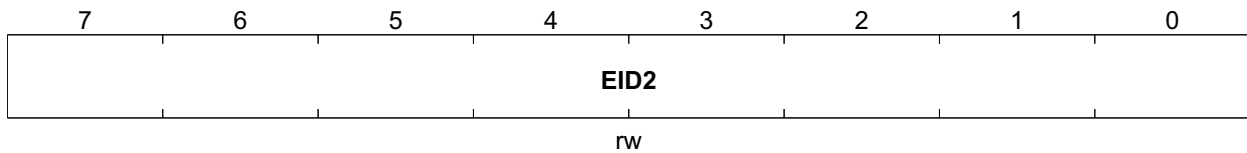

Field	Bits	Type	Description
EID2	7:0	rw	Ethernet ID 2 The 3rd byte of Ethernet ID.

Ethernet ID 3

EID3	Offset	Reset Value
Ethernet ID 3	13 _H	00 _H

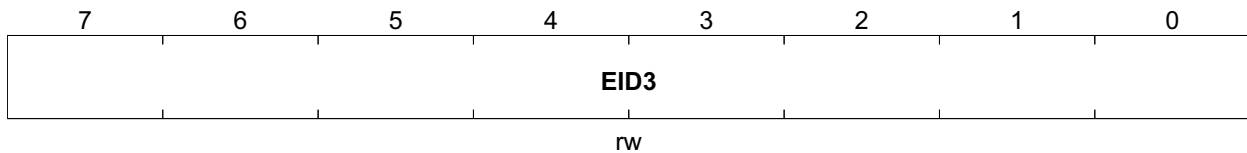

Field	Bits	Type	Description
EID3	7:0	rw	Ethernet ID 3 The 4th byte of Ethernet ID.

Ethernet ID 4

EID4	Offset	Reset Value
Ethernet ID 4	14 _H	00 _H



Field	Bits	Type	Description
EID4	7:0	rw	Ethernet ID 4 The 5th byte of Ethernet ID.

Ethernet ID 5

EID5	Offset	Reset Value
Ethernet ID 5	15 _H	00 _H

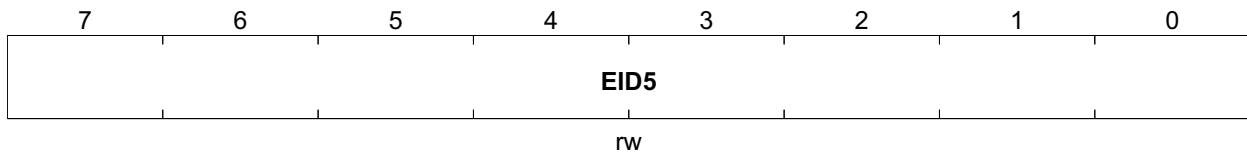

Field	Bits	Type	Description
EID5	7:0	rw	Ethernet ID 5 The 6th byte of Ethernet ID.

Pause Timer

PT **Offset**
Pause Timer **18_H** **Reset Value**
00_H

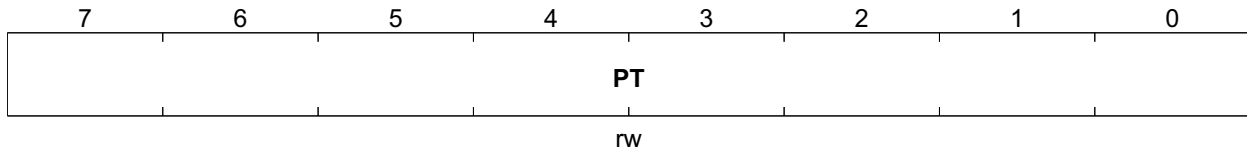

Field	Bits	Type	Description
PT	7:0	rw	Pause Timer The [11:4] of pause time in the PAUSE frame.

Receive Packet Number Based Flow Control

RPNBFC **Offset**
Receive Packet Number Based Flow Control **1A_H** **Reset Value**
00_H

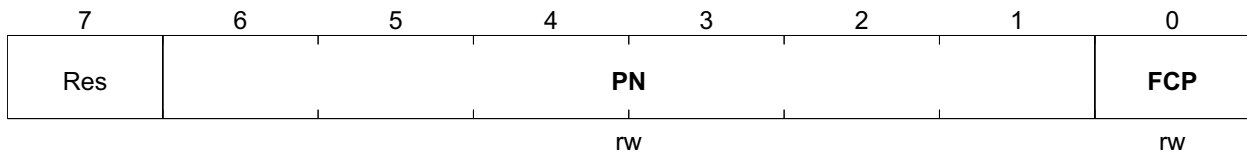

Field	Bits	Type	Description
PN	6:1	rw	Packet Number This field specifies the threshold for transmitting the PAUSE frame. As the received packet number is more than or equal to this field, the PAUSE frame is sent automatically by HW.
FCP	0	rw	Flow Control Packet 1 _B RPN, Enables pause frame transmission based on received packet number

Occupied Receive FIFO Based Flow Control

ORFBFC **Offset**
Occupied Receive FIFO Based Flow Control **1B_H** **Reset Value**
00_H

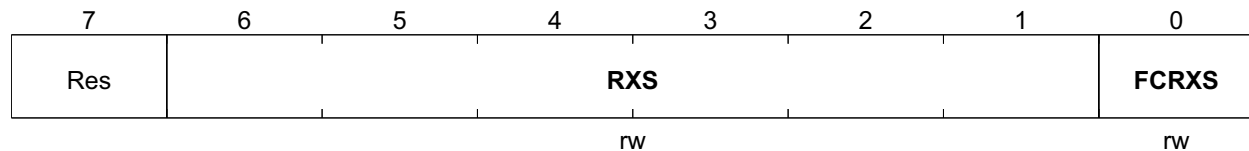

Field	Bits	Type	Description
RXS	6:1	rw	RX Size This field specifies the Kbyte threshold for transmitting the PAUSE frame. As the received FIFO is occupied than or equal to this field, the PAUSE frame is sent automatically by HW. If this field = 2, as receive FIFO is occupied more than or equal to 2 Kbyte, the PAUSE frame is transmitted.
FCRXS	0	rw	Flow Control RX Size 1 _B RFS , Enables pause frame transmission based on occupied received FIFO size

EP1 Control

EP1C **Offset**
EP1 Control **1C_H** **Reset Value**
04_H

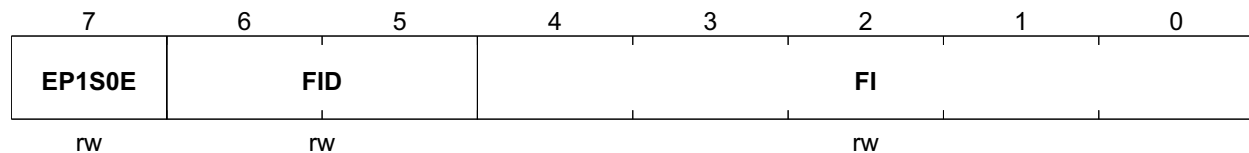

Field	Bits	Type	Description
EP1S0E	7	rw	EP1 Send 0 _B DEP1 , Disables EP1 send 1-byte 00 function 1 _B EEP1 , Enables EP1 send 1-byte 00 when more than frame_interval's NAK is received
FID	6:5	rw	Frame Interval Detail This value is the detailed scale of frame interval, it is from 0ms to 3ms. 00 _B , for more than 0 plus frame_interval ms NAK, EP1 sends 1-byte 00 01 _B , for more than 1 plus frame_interval ms NAK, EP1 sends 1-byte 00 11 _B , for more than 3 plus frame_interval ms NAK, EP1 sends 1-byte 00

Registers Description

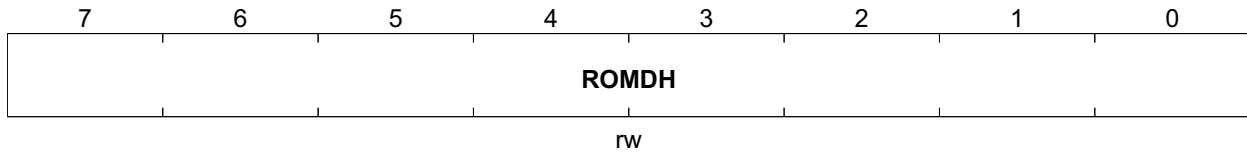

Field	Bits	Type	Description
ROMDH	7:0	rw	ROM Data High EEPROM Write: The data set in this register will be written to EEPROM EEPROM Read: The data read from EEPROM will be stored in this register

PHY Data Low

PHYDL PHY Data Low	Offset 26_H	Reset Value 00_H
------------------------------	--	---

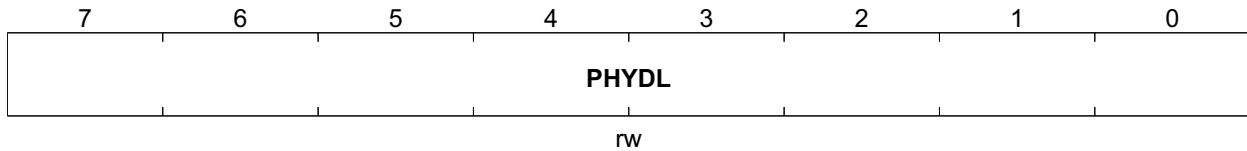

Field	Bits	Type	Description
PHYDL	7:0	rw	PHY Data Low SW set this register when write to PHY register. HW set this register when read data from PHY register.

PHY Data High

PHYDH PHY Data High	Offset 27_H	Reset Value 00_H
-------------------------------	--	---

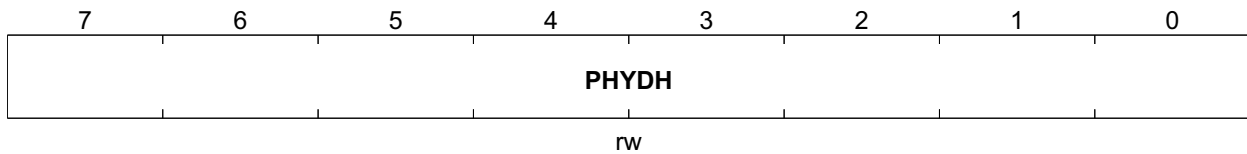

Field	Bits	Type	Description
PHYDH	7:0	rw	PHY Data High SW set this register when write to PHY register. HW set this register when read data from PHY register.

Registers Description
PHY Access Control

PHYAC **Offset**
PHY Access Control **28_H** **Reset Value**
00_H

7	6	5	4	3	2	1	0
DO	RDPHY	WRPHY	PHYRA				
rw	rw	rw	rw				

Field	Bits	Type	Description
DO	7	rw	Done Set by HW to indicate successful completion of PHY access. Clear by SW when initiate a new access to PHY.
RDPHY	6	rw	Read Access to PHY Register Set by SW to initiate a read access to PHY register. SW set this bit after it well setting the phy_addr and phyreg_addr.
WRPHY	5	rw	Write Access to PHY Register Set by SW to initiate a write access to PHY register. SW set this bit after it well setting the phy_addr, phyreg_addr and phyreg_data.
PHYRA	4:0	rw	PHY Register Address

USB Bus Status

USBBS **Offset**
USB Bus Status **2A_H** **Reset Value**
00_H

7	6	5	4	3	2	1	0
Res						USBR	USBS
						rw	rw

Field	Bits	Type	Description
USBR	1	rw	USB Bus in Resume State Set by HW to indicate usb bus in resumed state. Clear by SW read this register.
USBS	0	rw	USB Bus in Suspend State Set by HW to indicate usb bus in suspended state. Clear by SW read this register.

Transmit Status 1

Registers Description

TS1 **Offset** **Reset Value**
Transmit Status 1 **2B_H** **00_H**

	7	6	5	4	3	2	1	0
	TXUE	EC	LC	NC	CL	JTO	Res	
	r	r	r	r	r	r		

Field	Bits	Type	Description
TXUE	7	r	TX Underrun Error Set by HW to indicate tx underrun error. Clear by SW read this register or after EP3 is accessed.
EC	6	r	Excessive Collision Set by HW to indicate excessive collision. Clear by SW read this register or after EP3 is accessed.
LC	5	r	Late Collision Error Set by HW to indicate late collision error. Clear this register by SW Read or after EP3 is accessed.
NC	4	r	No Carrier Set by HW to indicate no carrier. Clear this register by SW Read or after EP3 is accessed.
CL	3	r	Carrier Loss Set by HW to indicate carrier loss. Clear this register by SW Read or after EP3 is accessed.
JTO	2	r	Jabber Time Out Set by HW to indicate jabber time out. Clear this register by SW Read or after EP3 is accessed.

Registers Description
Transmit Status 2

TS2 **Offset**
Transmit Status 2 **2C_H** **Reset Value**
00_H

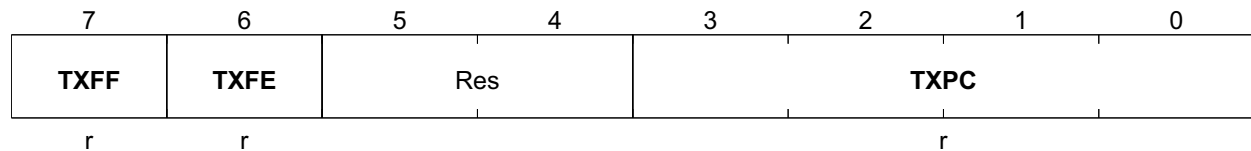

Field	Bits	Type	Description
TXFF	7	r	TX Fifo Full Set by HW to indicate tx fifo full. Clear this register by SW Read or after EP3 is accessed.
TXFE	6	r	TX Fifo Empty Set by HW to indicate tx fifo empty. Clear this register by SW Read or after EP3 is accessed.
TXPC	3:0	r	TX Packet Count Set by HW to indicate Ethernet transmit packet counts every interrupt EP polling. If more than 15 packets have been transmitted, this value will stay as 15. Clear by SW read or after EP3 is accessed.

Receive Status

RS **Offset**
Receive Status **2D_H** **Reset Value**
00_H

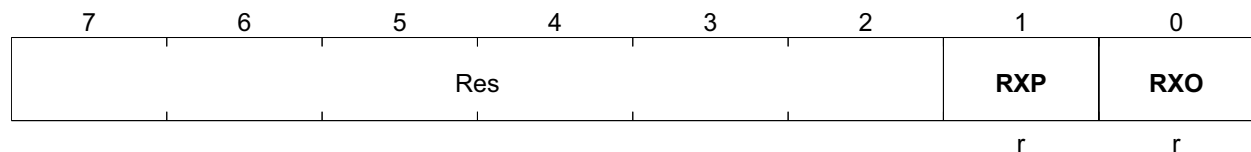

Field	Bits	Type	Description
RXP	1	r	RX Pause Set by HW to indicate a PAUSE frame is received. Clear this register by SW Read or after EP3 is accessed.
RXO	0	r	RX Overflow Set by HW to indicate external SRAM overflow. Clear this register by SW Read or after EP3 is accessed.

Receive Lost Packet Count High

RLPCH **Offset**
Receive Lost Packet Count High **2E_H** **Reset Value**
00_H

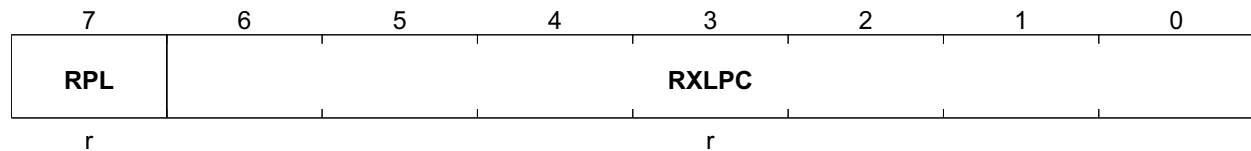

Field	Bits	Type	Description
RPL	7	r	Received Packet Lost
RXLPC	6:0	r	RX Lost Packet Counts The [14:8] of lost packet counts due to receive FIFO overflow. Clear this register by SW Read or after EP3 is accessed.

Receive Lost Packet Count Low

RLPCL **Offset**
Receive Lost Packet Count Low **2F_H** **Reset Value**
00_H

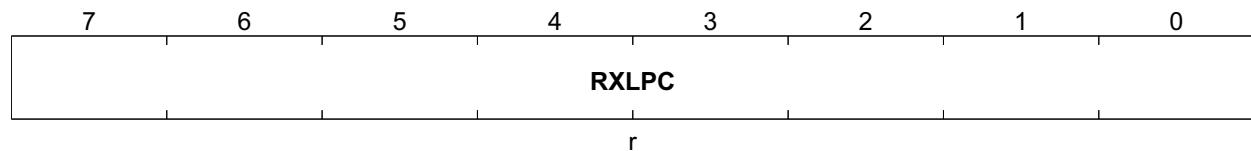

Field	Bits	Type	Description
RXLPC	7:0	r	RX Lost Packet Counts The [7:0] of lost packet counts due to receive FIFO overflow. Clear this register by SW Read or after EP3 is accessed.

Wakeup Frame 0 Mask

WUF0M_0 **Offset**
Wakeup Frame 0 Mask **30_H** **Reset Value**
00_H

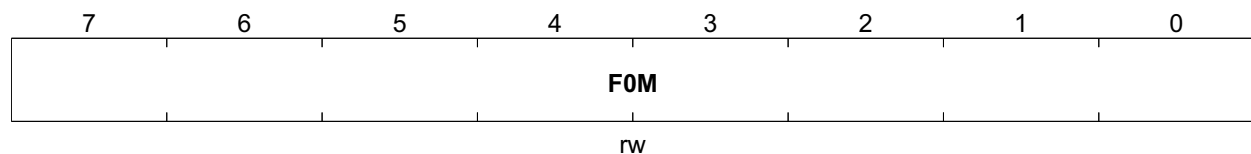

Registers Description

Field	Bits	Type	Description
F0M	7:0	rw	The 128 Mask Bits for Frame 0

Similar Registers
Table 68 Wakeup Frame 0 Mask Registers

Register Short Name	Register Long Name	Offset Address	Page Number
WUF0M_1	Wakeup Frame 0 Mask 1	31 _H	
WUF0M_2	Wakeup Frame 0 Mask 2	32 _H	
WUF0M_3	Wakeup Frame 0 Mask 3	33 _H	
WUF0M_4	Wakeup Frame 0 Mask 4	34 _H	
WUF0M_5	Wakeup Frame 0 Mask 5	35 _H	
WUF0M_6	Wakeup Frame 0 Mask 6	36 _H	
WUF0M_7	Wakeup Frame 0 Mask 7	37 _H	
WUF0M_8	Wakeup Frame 0 Mask 8	38 _H	
WUF0M_9	Wakeup Frame 0 Mask 9	39 _H	
WUF0M_10	Wakeup Frame 0 Mask 10	3A _H	
WUF0M_11	Wakeup Frame 0 Mask 11	3B _H	
WUF0M_12	Wakeup Frame 0 Mask 12	3C _H	
WUF0M_13	Wakeup Frame 0 Mask 13	3D _H	
WUF0M_14	Wakeup Frame 0 Mask 14	3E _H	
WUF0M_15	Wakeup Frame 0 Mask 15	3F _H	

Wakeup Frame 0 Offset

WUF00_0	Offset	Reset Value
Wakeup Frame 0 Offset	40_H	00_H

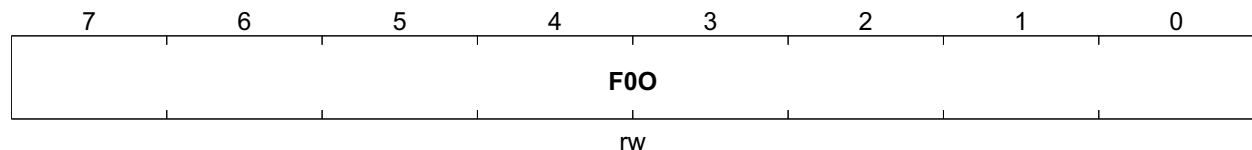

Field	Bits	Type	Description
F0O	7:0	rw	Offset for Wakeup Frame 0

Registers Description

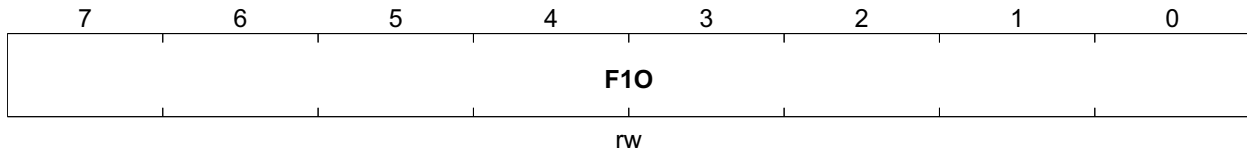

Field	Bits	Type	Description
F10	7:0	rw	Offset for Wakeup Frame 1

Registers Description

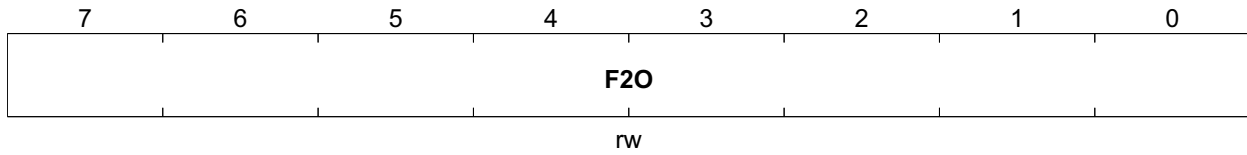

Field	Bits	Type	Description
F20	7:0	rw	Offset for Wakeup Frame 2

Wakeup Frame 2 CRC Low

WUF2CRCL	Offset	Reset Value
Wakeup Frame 2 CRC Low	71 _H	00 _H

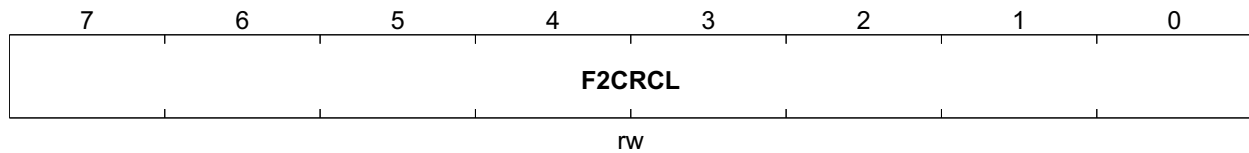

Field	Bits	Type	Description
F2CRCL	7:0	rw	The Low Byte of CRC16 Match for Frame 2

Wakeup Frame 2 CRC High

WUF2CRCH	Offset	Reset Value
Wakeup Frame 2 CRC High	72 _H	00 _H

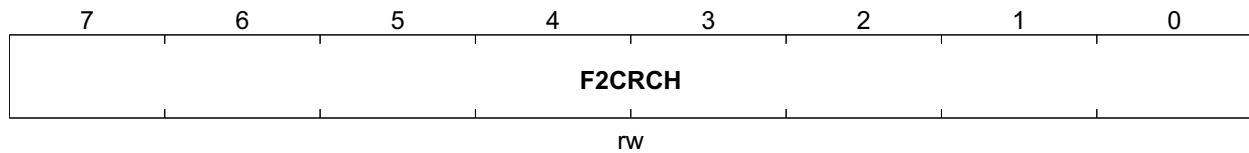

Field	Bits	Type	Description
F2CRCH	7:0	rw	The High Byte of CRC16 Match for Frame 2

Registers Description
Wakeup Status

WUS **Offset**
Wakeup Status **7A_H** **Reset Value**
00_H

	7	6	5	4	3	2	1	0
	RXMP	LW	RXWF	Res				LS
	r	r	r					r

Field	Bits	Type	Description
RXMP	7	r	Receives a Magic Packet Set by HW when receive a magic packet. Clear by SW read this register. 1 _B RMP , Means ADM8513/X receives a magic packet
LW	6	r	Receives a Link Status Change Set by HW when link status change. Clear by SW read this register. 1 _B RLS , Means ADM8513/X receives a link status change
RXWF	5	r	Receives a Wakeup Frame Set by HW when receive a wakeup frame. Clear by SW read this register. 1 _B RWF , Means ADM8513/X receives a wakeup frame
LS	0	r	Indicate the Current Link Status link_sts 0 _B LOFF , Link off 1 _B LON , Link on

Internal PHY Control

IPHYC **Offset**
Internal PHY Control **7B_H** **Reset Value**
00_H

	7	6	5	4	3	2	1	0
	Res						EPHY	PHYR
							rw	rw

Field	Bits	Type	Description
EPHY	1	rw	Enable PHY 0 _B DIN , Disables internal 10/100 PHY 1 _B EIN , Enables internal 10/100 PHY

Registers Description

Field	Bits	Type	Description
PHYR	0	rw	Internal PHY Reset The internal PHY is reset when this bit is written with 1 and stops reset when this bit is written with 0. 1 _B RIPHY , Reset internal PHY

GPIO[5:4] Control

GPIO54C **Offset** **Reset Value**
GPIO[5:4] Control **7C_H** **00_H**

7	6	5	4	3	2	1	0
Res		G5OE	G5OV	G5IV	G4OE	G4OV	G4IV
		rw	rw	r	rw	rw	r

Field	Bits	Type	Description
G5OE	5	rw	GPIO5 Output Enable 0 _B IN , GPIO5 is used for input 1 _B OUT , GPIO5 is used for output
G5OV	4	rw	GPIO5 Output Value When GPIO5 is used for output, this value is driven to GPIO5 pin.
G5IV	3	r	GPIO5 Input Value When GPIO5 is used for input, this field reflects the status of GPIO5. Default is pulled-down.
G4OE	2	rw	GPIO4 Output Enable 0 _B IN , GPIO4 is used for input 1 _B OUT , GPIO4 is used for output
G4OV	1	rw	GPIO4 Output Value When GPIO4 is used for output, this value is driven to GPIO4 pin.
G4IV	0	r	GPIO4 Input Value When GPIO4 is used for input, this field reflects the status of GPIO4. Default is pulled-down.

GPIO[1:0] Control

GPIO10C GPIO[1:0] Control	Offset 7E_H	Reset Value 00_H
--	--	---

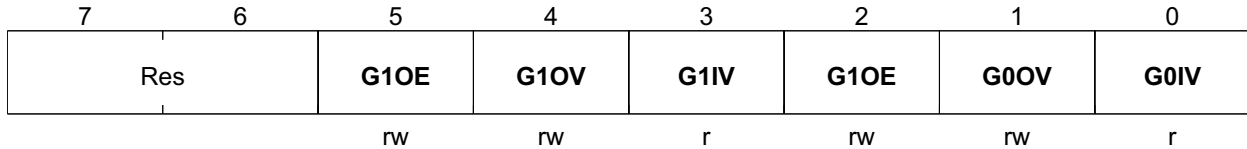

Field	Bits	Type	Description
G1OE	5	rw	GPIO1 Output Enable 0 _B IN , GPIO1 is used for input 1 _B OUT , GPIO1 is used for output
G1OV	4	rw	GPIO1 Output Value When GPIO1 is used for output, this value is driven to GPIO1 pin. Set by SW.
G1IV	3	r	GPIO1 Input Value When GPIO1 is used for input, this field reflects the status of GPIO1. Set by HW.
G1OE	2	rw	GPIO0 Output Enable 0 _B IN , GPIO0 is used for input 1 _B OUT , GPIO0 is used for output
G0OV	1	rw	GPIO0 Output Value When GPIO0 is used for output, this value is driven to GPIO0 pin. Set by SW.
G0IV	0	r	GPIO0 Input Value When GPIO0 is used for input, this field reflects the status of GPIO0. Set by HW.

GPIO[3:2] Control

GPIO32C **Offset** **Reset Value**
GPIO[3:2] Control **7F_H** **00_H**

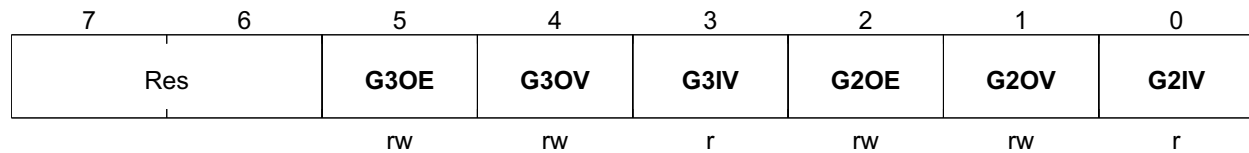

Field	Bits	Type	Description
G3OE	5	rw	GPIO3 Output Enable 0 _B IN , GPIO3 is used for input 1 _B OUT , GPIO3 is used for output
G3OV	4	rw	GPIO3 Output Value When GPIO3 is used for output, this value is driven to GPIO3 pin. Set by SW.
G3IV	3	r	GPIO3 Input Value When GPIO3 is used for input, this field reflects the status of GPIO3. Set by HW.
G2OE	2	rw	GPIO2 Output Enable 0 _B IN , GPIO2 is used for input 1 _B OUT , GPIO2 is used for output
G2OV	1	rw	GPIO2 Output Value When GPIO2 is used for output, this value is driven to GPIO2 pin. Set by SW.
G2IV	0	r	GPIO2 Input Value When GPIO2 is used for input, this field reflects the status of GPIO2. Set by HW.

TEST

Test	Offset	Reset Value
TEST	80 _H	00 _H

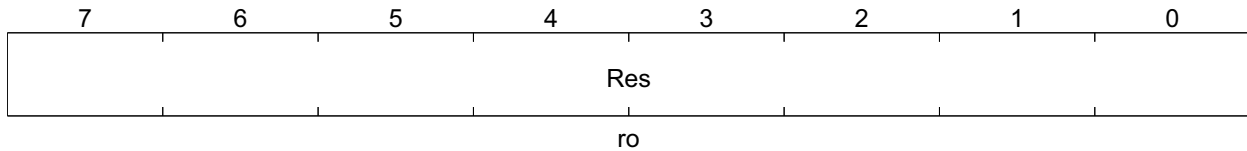

Field	Bits	Type	Description
Res	7:0	ro	Reserved

Test Mode

TM	Offset	Reset Value
Test Mode	81 _H	00 _H

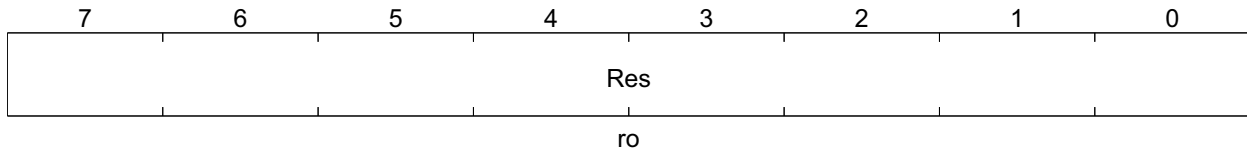

Field	Bits	Type	Description
Res	7:0	ro	Reserved

6.2 PHY Registers Description

Table 71 Registers Address Space

Module	Base Address	End Address	Note
System Registers	0000 0000 _H	0000 0006 _H	

Table 72 Registers Overview

Register Short Name	Register Long Name	Offset Address	Page Number
CTL	Control	0 _H	67
STA	Status	1 _H	68
PHYI1	PHY Identifier 1	2 _H	70
PHYI2	PHY Identifier 2	3 _H	70
ANA	Auto-Negotiation Advertisement	4 _H	71

Registers Description
Table 72 Registers Overview (cont'd)

Register Short Name	Register Long Name	Offset Address	Page Number
ANLPA	Auto-Negotiation Link Partner Ability	5 _H	72
ANE	Auto-Negotiation Expansion	6 _H	72

The register is addressed wordwise.

Table 73 Register Access Types

Mode	Symbol	Description HW	Description SW
read/write	rw	Register is used as input for the HW	Register is readable and writable by SW
read	r	Register is written by HW (register between input and output -> one cycle delay)	Value written by software is ignored by hardware; that is, software may write any value to this field without affecting hardware behavior (= Target for development.)
Read only	ro	Register is set by HW (register between input and output -> one cycle delay)	SW can only read this register
Read virtual	rv	Physically, there is no new register, the input of the signal is connected directly to the address multiplexer.	SW can only read this register
Latch high, self clearing	lhsc	Latch high signal at high level, clear on read	SW can read the register
Latch low, self clearing	llsc	Latch high signal at low-level, clear on read	SW can read the register
Latch high, mask clearing	lhmk	Latch high signal at high level, register cleared with written mask	SW can read the register, with write mask the register can be cleared (1 clears)
Latch low, mask clearing	llmk	Latch high signal at low-level, register cleared on read	SW can read the register, with write mask the register can be cleared (1 clears)
Interrupt high, self clearing	ihsc	Differentiate the input signal (low->high) register cleared on read	SW can read the register
Interrupt low, self clearing	ilsc	Differentiate the input signal (high->low) register cleared on read	SW can read the register
Interrupt high, mask clearing	ihmk	Differentiate the input signal (high->low) register cleared with written mask	SW can read the register, with write mask the register can be cleared
Interrupt low, mask clearing	ilmk	Differentiate the input signal (low->high) register cleared with written mask	SW can read the register, with write mask the register can be cleared
Interrupt enable register	ien	Enables the interrupt source for interrupt generation	SW can read and write this register
latch_on_reset	lor	rw register, value is latched after first clock cycle after reset	Register is readable and writable by SW
Read/write self clearing	rwsc	Register is used as input for the hw, the register will be cleared due to a HW mechanism.	Writing to the register generates a strobe signal for the HW (1 pdi clock cycle) Register is readable and writable by SW.

Table 74 Registers Clock DomainsRegisters Clock Domains

Clock Short Name	Description

6.2.1 PHY Registers

Control

CTL **Offset**
Control **0_H** **Reset Value**
1000_H

15	14	13	12	11	10	9	8	7	6	5	4	3	2	1	0
RST	LP	SS	ANE	PD	ISO	RA	DM	CT	Res						
rwsc	rw	rw	rw	rw	rw	rwsc	rw	ro							

Field	Bits	Type	Description
RST	15	rwsc	Reset 0 _B NO , Normal operation 1 _B PR , PHY Reset
LP	14	rw	Loopback 0 _B DL , Disable loopback 1 _B EL , Enable loopback
SS	13	rw	Speed Selection 0 _B 10M , 10 Mbit/s 1 _B 100M , 100 Mbit/s
ANE	12	rw	Autonegotiation Enable 0 _B DAN , Disable auto-neg 1 _B EAN , Enable auto-neg
PD	11	rw	Power Down 0 _B NO , Normal operation 1 _B PD , Power Down
ISO	10	rw	Isolate 0 _B NO , normal operation 1 _B IPHY , isolate PHY from MII
RA	9	rwsc	Restart Autonegotiation 1 _B RAN , Restart Auto-neg
DM	8	rw	Duplex Mode 0 _B HA , Half 1 _B FU , Full
CT	7	ro	Collision Test Not implemented

SC

Self Clearing

Reset

Reset this port only. This will cause the following:

1. Restart the auto-negotiation process.

Registers Description

2. Reset the registers to their default values. Note that this does not affect registers 20, 22, 30 or 31. These registers are not reset by this bit to allow test configurations to be written and then not affected by resetting the port.

Note: No reset is performed to analogue sections of the port. There is also no physical reset to any internal clock synthesisers or the local clock recovery oscillator which will continue to run throughout the reset period. However since the port is restarted and autoneg re-run the process of locking the frequency of the local oscillator (slave) to the reference oscillator (master) will be repeated as it is at the start of any link initialization process.

Loopback Loop back of transmit data to receive via a path as closed to the wire as possible. When set inhibits actual transmission on the wire.

Speed Selection Forces speed of Phy only when auto-negotiation is disabled. The default state of this bit will be determined by a power-up configuration pin in this case. Otherwise it defaults to 1.

Auto-neg Enable Defaults to pin programmed value. When cleared allows forcing of speed and duplex settings. When set (after being cleared) causes re-start of auto-neg process. Pin programming at power-up allows it to come up disabled and for software to write the desired capability before allowing the first negotiation to commence.

Restart Negotiation Only has effect when auto-negotiating. Restarts state machine.

Power Down Has no effect in this device. Test mode power down modes may be implemented in other specific modules.

Isolate Puts RMII receive signals into high impedance state and ignores transmit signals.

Duplex Mode When bit12 is cleared (i.e. autoneg disabled), this bit forces full duplex (bit = 1) or half duplex (bit = 0).

Collision Test Always 0 because collision signal is not implemented.

Status

STA	Offset	Reset Value
Status	1_H	7849_H

15	14	13	12	11	10	9	8	7	6	5	4	3	2	1	0
100T 4	100F D	100H D	10FD	10HD	100T FD	100T HD	Res		MFPS	ANC	RF	ANA	LS	JD	EC
ro	ro	ro	ro	ro	ro	ro			ro	ro	ro, lh	ro	ro, ll	ro, lh	ro

Field	Bits	Type	Description
100T4	15	ro	100 BASE T4 Not supported
100FD	14	ro	100BASE-X Full Duplex 0 _B 100FDN , PHY is not 100BASE-X full duplex capable 1 _B 100FD , PHY is 100BASE-X full duplex capable
100HD	13	ro	100BASE-X Half Duplex 0 _B 100HDN , PHY is not 100BASE-X half duplex capable 1 _B 100HD , PHY is 100BASE-X half duplex capable
10FD	12	ro	10 Mbit/s Full Duplex 0 _B 10FDN , PHY is not 10 Mbit/s Full duplex capable 1 _B 10FD , PHY is 10 Mbit/s Full duplex capable

Registers Description

Field	Bits	Type	Description
10HD	11	ro	10 Mbit/s Half Duplex 0 _B 10HDN , PHY is not 10 Mbit/s Half duplex capable 1 _B 10HD , PHY is 10 Mbit/s Half duplex capable
100TFD	10	ro	100BASE-T2 Full Duplex Not Supported
100THD	9	ro	100BASE-T2 Half Duplex Not Supported
MFPS	6	ro	MF Preamble Suppression 0 _B MFPSN , PHY cannot accept management frames with preamble suppression 1 _B MFPS , PHY can accept management frames with preamble suppression
ANC	5	ro	Auto-neg Complete 0 _B ANI , Auto-neg incomplete 1 _B ANC , Auto-neg completed
RF	4	ro, lh	Remote Fault 0 _B RFN , No remote fault detected 1 _B RF , Remote fault detected
ANA	3	ro	Auto-neg Ability 0 _B ANN , PHY cannot auto-negotiate 1 _B AN , PHY can auto-negotiate
LS	2	ro, ll	Link Status 0 _B LD , Link is down 1 _B LU , Link is up
JD	1	ro, lh	Jabber Detect 1 _B JCD , Jabber condition detected
EC	0	ro	Extended Capability 0 _B BSC , Basic register set capabilities only 1 _B EC , Extended register capabilities

*Note: **Jabber Detect** Only used in 10Base-T mode. Read as 0 in 100Base-TX mode.*

PHY Identifier 2 and 3

Each PHY has an identifier, which is assigned to the device.

The identifier contains a total of 32 bits, which consists of the following: 22 bits of a 24 bit organizationally unique identifier (OUI) for the manufacturer; a 6-bit manufacturer's model number; a 4-bit manufacturer's revision number. For an explanation of how the OUI maps to the register, please refer to IEEE 802-1990 clause 5.1

PHY Identifier 1

PHYI1	Offset	Reset Value
PHY Identifier 1	2_H	001D_H

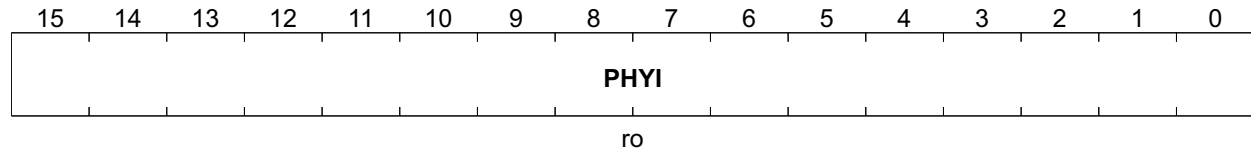

Field	Bits	Type	Description
PHYI	15:0	ro	PHY Identifier[31-16] OUI (bits 3-18)

PHY Identifier 2

PHYI2	Offset	Reset Value
PHY Identifier 2	3_H	2411_H

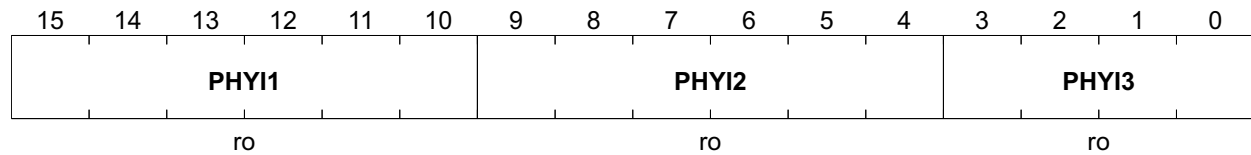

Field	Bits	Type	Description
PHYI1	15:10	ro	PHY Identifier[15-10] OUI (bits 19-24)
PHYI2	9:4	ro	PHY Identifier[9-4] Manufacturer's Model Number (bits 5-0)
PHYI3	3:0	ro	PHY Identifier[3-0] Revision Number (bits 3-0); Register 3, bit 0 is LS bit of PHY Identifier

Note: This uses the OUI of Infineon-ADMtek, device type of 1 and rev 0.

Auto-Negotiation Advertisement

ANA **Offset**
Auto-Negotiation Advertisement **Reset Value**
4_H **0001_H**

15	14	13	12	11	10	9	8	7	6	5	4	3	2	1	0
NP	Res	RF		NI	PAU	NI	100F D	100H D	10FD	10HD				SF	
rw		rw		ro	rw	ro	rw	rw	rw	rw				ro	

Field	Bits	Type	Description
NP	15	rw	Next Page 0 _B NNP , Device not set to use Next Page 1 _B NP , Device set to use Next Page
RF	13	rw	Remote Fault 0 _B NFD , No fault detected 1 _B RF , Local remote fault sent to link partner
NI	12:11	ro	Not Implemented Technology ability bits A7-A6
PAU	10	rw	Pause Technology ability bit A5
NI	9	ro	Not Implemented Technology ability bit A4
100FD	8	rw	100BASE-TX Full Duplex Technology ability bit A3 0 _B 100NFD , Unit is not capable of Full Duplex 1 _B 100FD , Unit is capable of Full Duplex
100HD	7	rw	100BASE-TX Half Duplex Technology ability bit A2 0 _B 100NHD , Unit is not capable of Half Duplex 100BASE-TX 1 _B 100HD , Unit is capable of Half Duplex
10FD	6	rw	10BASE-T Full Duplex Technology ability bit A1 0 _B 10NFD , Unit is not capable of Full Duplex 10BASE-T 1 _B 10FD , Unit is capable of Full Duplex 10BASE-T
10HD	5	rw	10BASE-T Half Duplex Technology ability bit A0 0 _B 10NHD , Unit is not capable of Half Duplex 10BASE-T 1 _B 10HD , Unit is capable of Half Duplex 10BASE-T
SF	4:0	ro	Selector Field Identifies type of message being sent. Currently only one value is defined.

Registers Description
Auto-Negotiation Link Partner Ability

The register is used to view the advertised capabilities of the link partner once auto negotiation is complete. The contents of this register should not be relied upon unless register 1 bit 5 is set (auto negotiation complete). After negotiation this register should contain a copy of the link partner's register 4. All bits are therefore defined in the same way as for register 4. All bits are readable only. This register is used for Base Page code word only. Base Page Register Format

ANLPA **Offset**
Auto-Negotiation Link Partner Ability **5_H** **Reset Value**
0000_H

15	14	13	12	11	10	9	8	7	6	5	4	3	2	1	0
NP	ACK	RF	TA						SF						
ro	ro	ro	ro						ro						

Field	Bits	Type	Description
NP	15	ro	Next Page 0 _B , Base Page is requested 1 _B , Link Partner is requesting Next Page function
ACK	14	ro	Acknowledge Link Partner acknowledgement bit
RF	13	ro	Remote Fault Link Partner is indicating a fault
TA	12:5	ro	Technology Ability Link Partner technology ability field.
SF	4:0	ro	Selector Field Link Partner selector field

Auto-Negotiation Expansion

ANE **Offset**
Auto-Negotiation Expansion **6_H** **Reset Value**
0004_H

15	14	13	12	11	10	9	8	7	6	5	4	3	2	1	0
Res											PDF	LPNP	NPA	PR	LPAN
											ro, lh	ro	ro	ro, lh	ro

Field	Bits	Type	Description
PDF	4	ro, lh	Parallel Detection Fault 0 _B NFD , No fault detected 1 _B FD , Local Device Parallel Detection Fault

Registers Description

Field	Bits	Type	Description
LPNP	3	ro	Link Partner Next Page Able 0 _B NNP , Link Partner is not Next Page Able 1 _B NP , Link Partner is Next Page Able
NPA	2	ro	Next Page Able 0 _B , Local device is not Next Page Able 1 _B , Local device is Next Page Able
PR	1	ro, lh	Page Received 0 _B NPR , A New Page has not been received 1 _B PR , A New Page has been received
LPAN	0	ro	Link Partner Auto Negotiation Able 0 _B NAN , Link Partner is not Auto negotiation able 1 _B AN , Link Partner is Auto negotiation able

7 Electrical Characteristics

7.1 Absolute Maximum Ratings

Table 75 Absolute Maximum Rating

Parameter	Symbol	Values			Unit	Note / Test Condition
		Min.	Typ.	Max.		
Supply Voltage	V_{DD}	–	–	4.6	V	–
DC Input Voltage	V_{IN}	–	–	6	V	–
DC Output Voltage	V_{OUT}	–	–	4.6	V	–
Power Consumption	P_C	–	–	126	mA	@ Idle State
		–	–	7	mA	@ Suspend Mode
		–	–	142	mA	@ 10M Full Duplex Mode
		–	–	152	mA	@ 100M Full Duplex Mode
Storage Temperature	T_{STG}	-65	–	150	°C	–
Operation Temperature	T_{AMB}	-40	–	125	W	–
ESD Rating	V_{ESD}	–	–	2000	V	–

7.2 Operating Condition

Table 76 Operating Condition

Parameter	Symbol	Values			Unit	Note / Test Condition
		Min.	Typ.	Max.		
Supply Voltage	V_{DD}	3.0	–	3.6	V	–
Supply Current	I_{DD}	–	–	150	mA	–

7.3 DC Specifications

7.3.1 USB Interface DC Specification

Table 77 USB Interface DC Specification

Parameter	Symbol	Values			Unit	Note / Test Condition
		Min.	Typ.	Max.		
Input High Voltage	V_{IH}	2.0	–	–	V	–
Input Low Voltage	V_{IL}	–	–	0.8	V	–
Differential Input Sensitivity	V_{DI}	0.2	–	–	V	–

Table 77 USB Interface DC Specification (cont'd)

Parameter	Symbol	Values			Unit	Note / Test Condition
		Min.	Typ.	Max.		
Differential Common Mode Range	V_{CM}	0.8	–	2.5	V	–
Output High Voltage	V_{CH}	2.8	–	3.6	V	–
Output Low Voltage	V_{OL}	0.0	–	0.3	V	–
Output Signal Crossover Voltage	V_{CRS}	1.3	–	2.0	V	–

8 EEPROM Interface DC Specification

8.1 Recommended Operating Conditions

Table 78 EEPROM Interface DC Specification

Parameter	Symbol	Values			Unit	Note / Test Condition
		Min.	Typ.	Max.		
Input High Voltage	V_{IH}	1.8	–	5.5	V	–
Input Low Voltage	V_{IL}	-0.5	–	1.0	V	–
Input Leakage Current	I_I	± 1	–	± 1000	nA	V_{IN} 3.3V or 0 V
Output High Voltage	V_{OH}	2.4	–	–	V	–
Output Low Voltage	V_{OL}	–	–	0.4	V	–
Input Pin Capacitance	C_{IN}	–	–	5.66	pF	–

8.2 GPIO Interface DC Specification

Table 79 GPIO Interface DC Specification

Parameter	Symbol	Values			Unit	Note / Test Condition
		Min.	Typ.	Max.		
Input High Voltage	V_{IH}	1.8	–	5.5	V	–
Input Low Voltage	V_{IL}	-0.5	–	1.0	V	–
Input Leakage Current	I_I	± 1	–	± 1000	nA	V_{IN} 3.3 V or 0 V
Output High Voltage	V_{OH}	2.4	–	–	V	–
Output Low Voltage	V_{OL}	–	–	0.4	V	–
Input Pin Capacitance	C_{IN}	–	–	5.64	pF	–

9 Timing

9.1 Reset Timing

ADM8513/X can be reset either by hardware, software or USB reset.

- A hardware reset is accomplished by asserting the RST# pin after powering up the device. It should have a duration of at least 100 ms to ensure the external 12 MHz and crystal is in stable and correct frequency. All registers will be reset to default values.
- A software reset is accomplished by setting the reset bit (bit 4) of the Ethernet Control Register (address 01_H). This software reset will reset all registers to default values.
- When ADM8513/X sees an SE0 on USB bus for more than 2.5 s. This USB reset will reset all registers to default values

9.2 USB Interface Timing

Table 80 GPIO Interface DC Specification

Parameter	Symbol	Values			Unit	Note / Test Condition
		Min.	Typ.	Max.		
Rise Time	T_{FR}	4	–	20	ns	$C_L=50$ pF
Fall Time	T_{FF}	4	–	20	ns	$C_L=50$ pF
Rise and fall time matching	T_{FRFF}	90	–	111.11	%	$T_{FRFF} = T_{FR} / T_{FF}$

9.3 EEPROM Interface Timing

Table 81 EEPROM Interface Timing

Parameter	Symbol	Values			Unit	Note / Test Condition
		Min.	Typ.	Max.		
EESK Clock Frequency	t_{EESK}	0	–	1	MHz	–
EECS Setup Time to EESK	t_{EECSS}	0.2	–	–	μs	–
EECS Hold Time from EESK	t_{EECSH}	0	–	–	ns	–
EEDO Hold Time from EESK	t_{EEDOH}	70	–	–	ns	–
EEDO Output Delay to “1” or “0”	t_{EEDOP}	–	–	2	μs	–
EEDI Setup Time to EESK	t_{EEDIS}	0.4	–	–	μs	–
EEDI Hold Time from EESK	t_{EEDIH}	0.4	–	–	μs	–

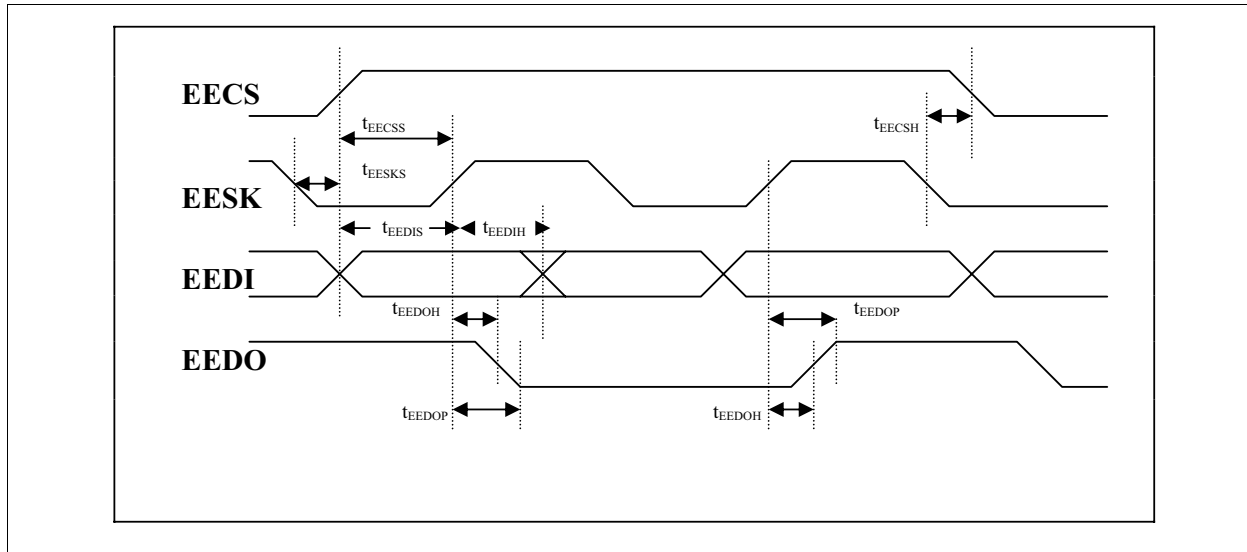
Figure 5 EEPROM Interface Timing

10 EEPROM Interface & Example

If the EEPROM contents from offset 0 to offset 5 is “FF_FF_FF_FF_FF_FF”, the EEPROM isn’t programmed correctly. The default values for every field are used instead of loading from EEPROM.

Table 82 EEPROM Interface

Offset(Byte)	Field	Description
00	node_id0	The 1st byte of Ethernet node ID.
01	node_id1	The 2st byte of Ethernet node ID.
02	node_id2	The 3st byte of Ethernet node ID.
03	node_id3	The 4st byte of Ethernet node ID.
04	node_id4	The 5st byte of Ethernet node ID.
05	node_id5	The 6st byte of Ethernet node ID.
06-07	Reserved	
08	Max_Pwr	The maximum USB power consumption.
09	Ep3_Interval	The polling interval for endpoint 3. If this value is 0, EP3 is disabled.
0A[0]	Reserved	
0A[1]	USB_Sel	0A[1] = 1: select internal USB transceiver.
0A[4:2]	PHY Mode	0A[4:2]= 000
0B[0]	Reserved	
0B[5:1]	Reserved	
0B[7:6]	LED Mode	Refer to Pin assignment
0C	Languageid_lo	The low byte of language ID.
0D	Languageid_hi	The high byte of language ID.
0E-0F	Reserved	
10	Manuid_lo	The low byte of manufacture ID.
11	Manuid_hi	The high byte of manufacture ID.

Table 82 EEPROM Interface (cont'd)

Offset(Byte)	Field	Description
12	ProID_lo	The low byte of product ID.
13	ProID_hi	The high byte of product ID.
14	Manu_str_len	The length for manufacture string.
15	Manu_str_offset	The word offset address of manufacture string.
16	Pro_str_len	The length for product string.
17	Pro_str_offset	The word offset address of product string.
18	Seri_str_len	The length for serial number string.
19	Seri_str_offset	The word offset address of serial number string.

10.1 Example

offset(byte)	Value
0000 _H :	00, 00 E8 00 02 2C 00 00,
0008 _H :	50 01 02 00 09 04 00 00
0010 _H :	A6 07 13 85 0E 10 2A 20
0018 _H :	0A 38 00 00 00 00 00 00
0020 _H :	0E 03 41 00 44 00 4D 00
0028 _H :	74 00 65 00 6B 00 00 00
0030 _H :	1E 00 55 00 53 00 42 00
0038 _H :	20 00 31 00 30 00 2F 00
0040 _H :	2A 03 55 00 53 00 42 00
0048 _H :	-20 00 54 00 6F 00 20 00
0050 _H :	4C 00 41 00 4E 00 20 00
0058 _H :	43 00 6F 00 6E 00 76 00
0060 _H :	65 00 72 00 74 00 65 00
0068 _H :	72 00 00 00 00 00 00 00
0070 _H :	0A 03 30 00 30 00 30 00
0078 _H :	31 00 00 00 00 00 00 00

Table 83 EEPROM Example

Offset(Byte)	Value	Description
00-05	00_00_E8_10 _46_02	NIC node ID
08	50	maximum power 160mA
09	01	interrupt endpoint 3 polling interval 1ms
0A	02	isochronous endpoint disables, selects internal USB transceiver Uses internal Ethernet PHY, Wakes on Lan en
0C-0D	0904	Language ID 0409
10-11	A607	manufacture ID 07A6
12-13	8513	product ID 8513
14	0E	manufacture string length 0E bytes
15	10	manufacture string starts from word offset 10h, thus byte offset 20 _H .

Table 83 EEPROM Example (cont'd)

Offset(Byte)	Value	Description
16	1E	product string length 1E bytes
17	18	product string starts from word offset 18h, thus byte offset 30 _H .
18	0A	serial number string length 0A bytes
19	38	serial number string starts from word offset 38h, thus byte offset 70 _H .
20-2E	0E 03 41 00 44 00 4D 00 74 00 65 00 6B 00	0E:descriptor size 14 bytes 03: string descriptor 41.....: UNICODE encoded string
30-4E	1E 03 55 00 53 00 42 00 20 00.....	1E:descriptor size 30 bytes 03: string descriptor 55.....: UNICODE encoded string
50-5A	0A 03 30 00 30 00 30 00 31 00	0A: descriptor size 10 bytes 03: string descriptor 30.....: UNICODE encoded string

11 Package

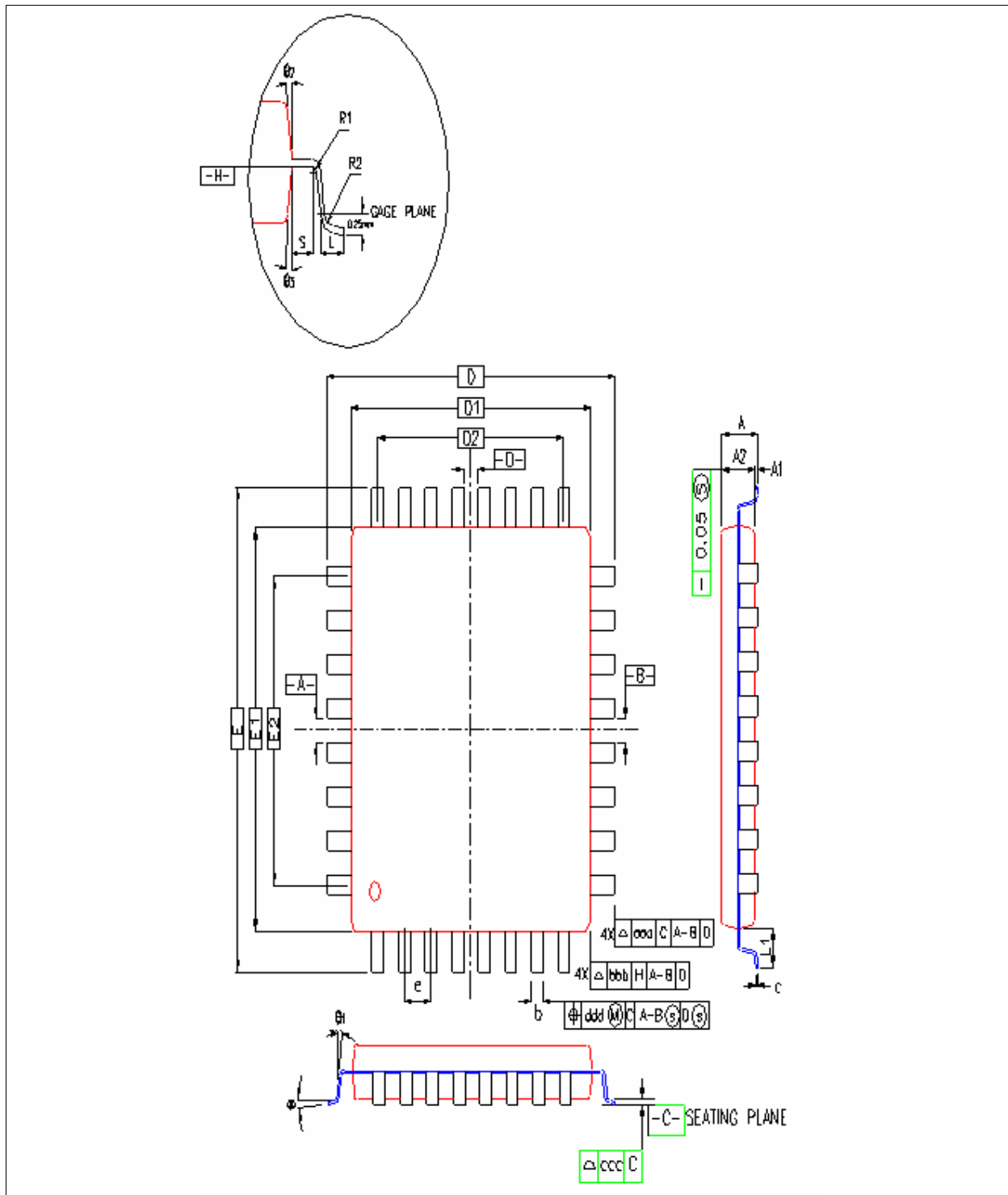

Figure 6 Package

Note: This diagram has a 32pin. But, the relative parameters presents 48pin package data. So, please ignore the pin number and regard the diagram as 48pin. Make an example: Parameter "E" (9mm) means the distance between the two opposite sides. Parameter "e" (0.8mm) means the distance between two adjacent pins. D&E1 means body size.

Table 84 Dimensions for 48 Pin LQFP Package

Symbol	Millimeter (mm)			Inch		
	Min.	Typ.	Max.	Min.	Typ.	Max.
A	–	–	1.60	–	–	0.063
A ₁	0.05	–	0.15	0.002	–	0.006
A ₂	1.35	1.40	1.45	0.053	0.005	0.057
D	9.00 BSC.			0.354 BSC.		
D ₁	7.00 BSC			0.276 BSC.		
E	9.00 BSC			0.354 BSC.		
E ₁	7.00 BSC			0.276 BSC.		
R ₂	0.08	–	0.20	0.003	–	0.008
R ₁	0.08	–	–	0.003	–	–
Θ	0°	3.5°	7°	0°	3.5°	7°
Θ ₁	0°	–	–	0°	–	–
Θ ₂	11°	12°	13°	11°	12°	13°
Θ ₃	11°	12°	13°	11°	12°	13°
c	0.09	–	0.20	0.004	–	0.008
L	0.45	0.60	0.75	0.018	0.024	0.030
L ₁	1.00 Ref.			0.039 Ref.		
S	0.20	–	–	0.008	–	–
32L						
b	0.30	0.35	0.45	0.0012	0.0014	0.018
e	0.80 BSC.			0.031 BSC.		
D ₂	5.60			0.220		
E ₂	5.60			0.220		
Tolerance of Form and Position						
aaa	0.20			0.008		
bbb	0.20			0.008		
ccc	0.10			0.003		
ddd	0.20			0.008		
34L						
b	0.17	0.20	0.27	0.007	0.008	0.011
e	0.50 BSC.			0.020 BSC.		
D ₂	5.00			0.197		
E ₂	5.00			0.197		
Tolerance of Form and Position						
aaa	0.20			0.008		
bbb	0.20			0.008		
ccc	0.08			0.003		
ddd	0.08			0.003		
48L						
b	0.17	0.20	0.27	0.007	0.008	0.011

Table 84 Dimensions for 48 Pin LQFP Package (cont'd)

Symbol	Millimeter (mm)	Inch
e	0.50 BSC.	0.020 BSC.
D ₂	5.50	0.217
E ₂	5.50	0.217
Tolerance of Form and Position		
aaa	0.20	0.008
bbb	0.20	0.008
ccc	0.08	0.003
ddd	0.08	0.003

12 Appendix Layout Guide

Placement:

- At USB side, place ADM8513/X and USB connector as close as possible.
- At Ethernet side, place ADM8513/X, transformer and RJ45 as close as possible.
- The crystal or OSC device should be closed to ADM8513/X and away from the following items
 - Any analog signal
 - PCB edge
 - Any other high frequency components and their associated traces.

If you can't avoid those designs, please add a Resistor between Crystal (or OSC) and ADM8513/X chip clk48_I pin as figure show:

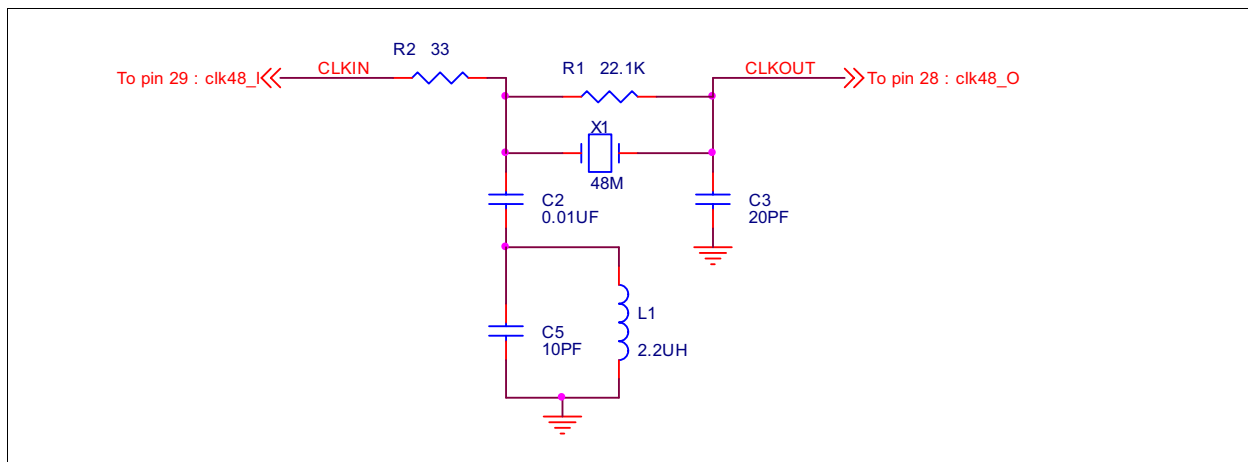

Figure 7 Placement 1

- Place the filtering capacitor as closed as possible at the Vcc pin of ADM8513/X and its trace must be short and wide.

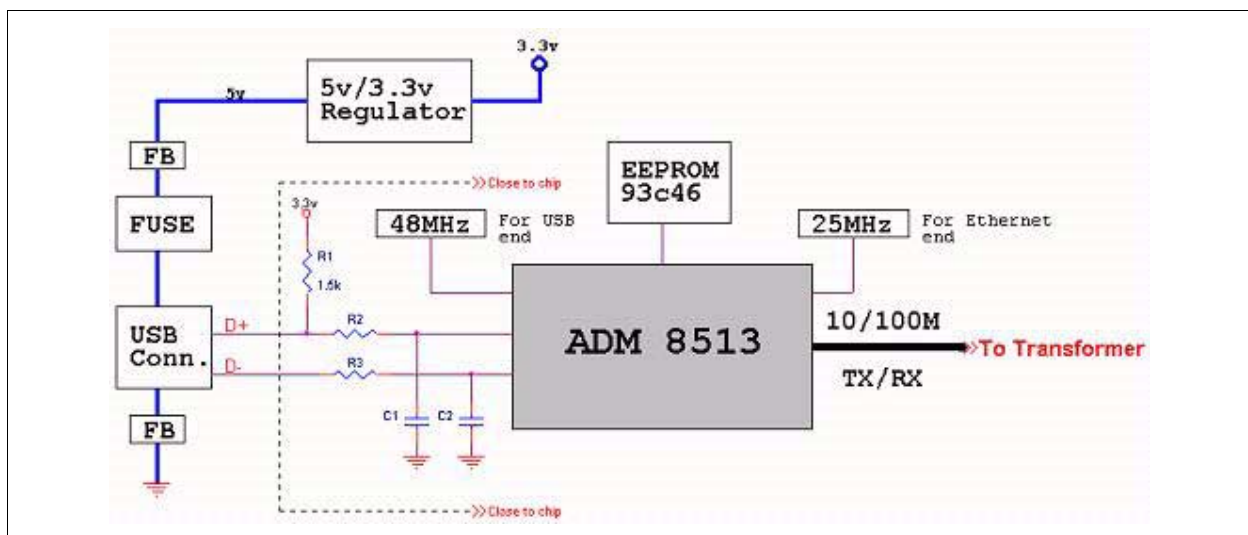
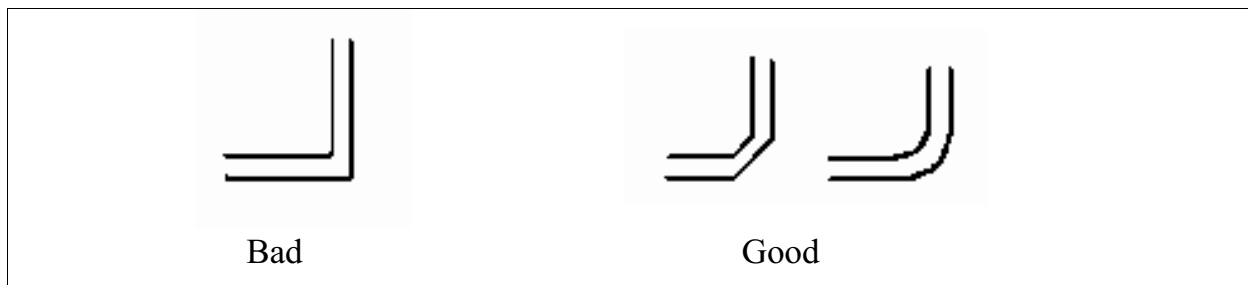
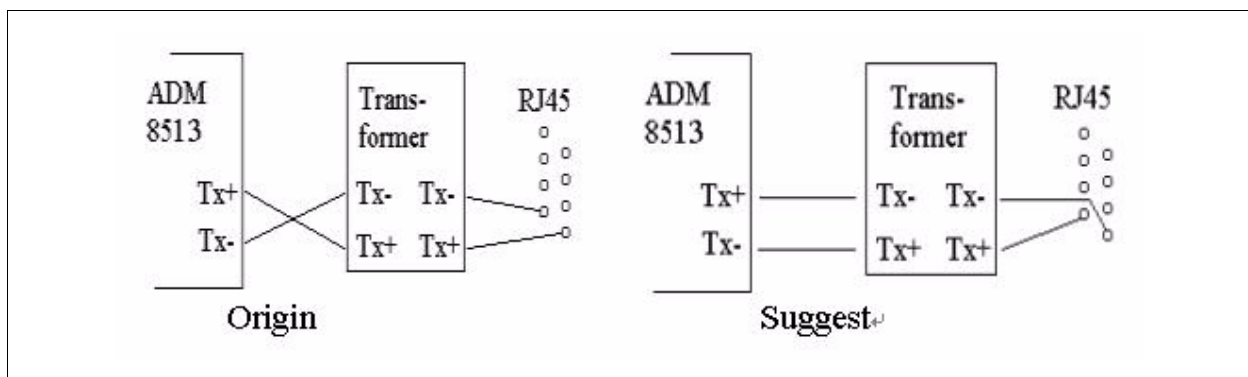

Figure 8 Placement 2

Trace routing

- Keep USB differential pair data signal D+ and D-:
 - Trace width should be as wide as possible.
 - Make D+ and D- traces route at the same signal plane and not pass through the other plane.
 - Inhibit crossover on D+ and D-
 - The termination resistance (R2,R3) and decoupling capacitors (C1,C2) should be closed to ADM8513/X.
 - D+ and D- Signal trace length should be equal and as short as possible.
- Arrangement Tx and Rx trace
 - Tx+/- and Rx+/- trace avoid right angle and round angle >90 degree, suggested.
 - Trace width must be wide and should be wider than 8 mils.
 - Signal trace length between Tx+/- differential pairs should be crossed and have equal length. The total length should be no longer than 2 cm. The same requirement applies to Rx+/- also.
 - Make Tx and Rx trace route at the same signal plane and not pass through the other plane.
 - Every differential pairs as cross as possible, but no less than 8 mils and space should be almost equal.
 - Keep space large between Tx and Rx differential pairs, even separated ground planes underneath Tx and Rx signal pairs.
 - Away from clock and power traces.
 - If Tx routed trace must cross, the trace can be swapped between chip and transformer, and transformer to RJ45, too.

Figure 9 Trace Routing 1

Figure 10 Trace Routing 2

- Digital signal should be away from analog signal and Vcc traces. If you can't avoid this situation, analog signal or Vcc trace should cross over 90 degree at other plane.

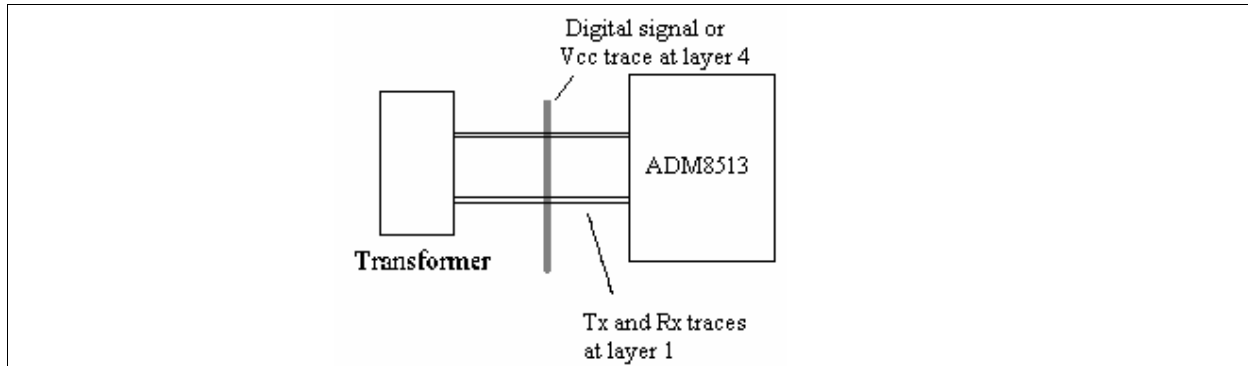

Figure 11 Trace Routing 3

- Vcc trace should be short and prefer route in the format of the plane a special for GND.

Power and Ground

- All of the Vcc pin should have a 0.1uF SMD capacitors which placed with it. To be effective, the capacitors should be placed as close as possible at the pin.
- The chassis ground plane connected to the USB B type and network connector chassis should be isolated from the signal plane with 0.1uF capacitors or bead to prevent any radiation from leaking and resulting in EMI failure.
- Right angle is recommend when partition Vcc as well as GND planes.
- Avoid Vcc and ground planes placing directly under the transformer. See the Figure as below.

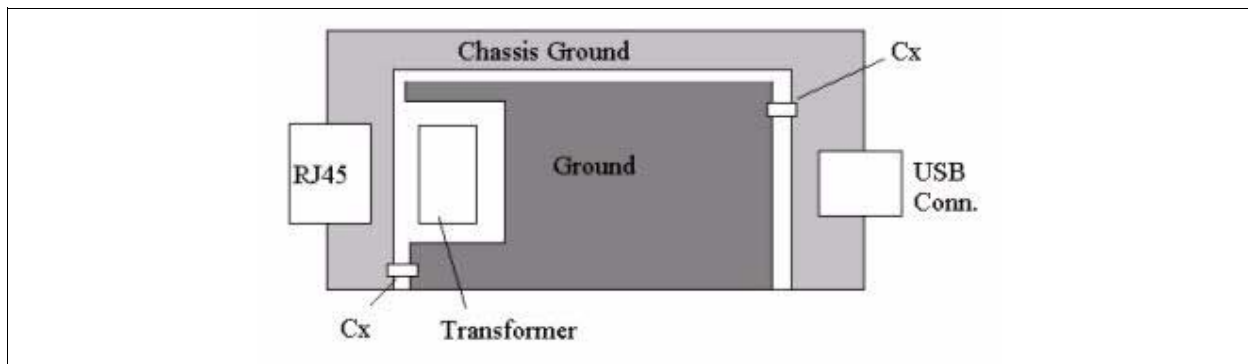

Figure 12 Power and Ground 1

- If you use a captive cable (plus the shield wire) it may require additional filtering for EMI test pass and the length of unshielded cable should be limited to 3cm or less.

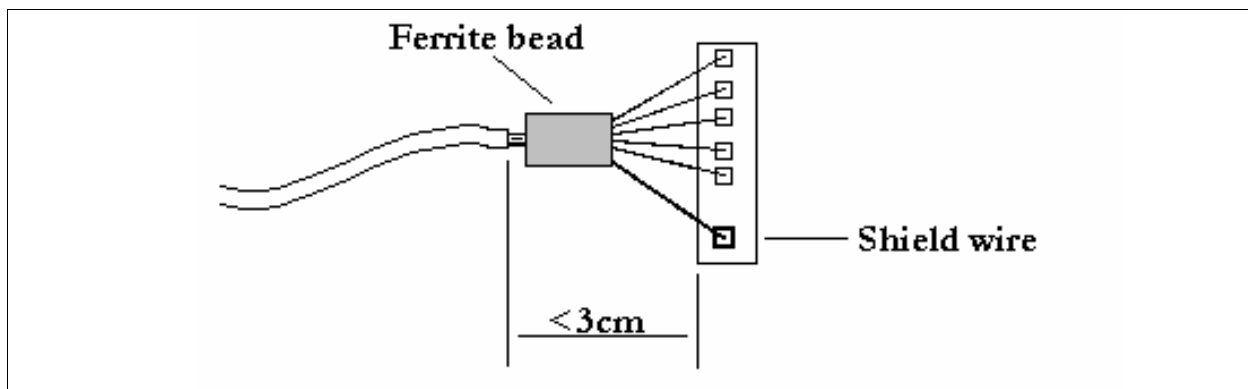

Figure 13 Power and Ground 2

- Please connect 10K Ohm Ribb resistance gnd, pin40(GndRef) and pin37(GndR) first then use signal via to Gnd (Specially for 2 layers board design).

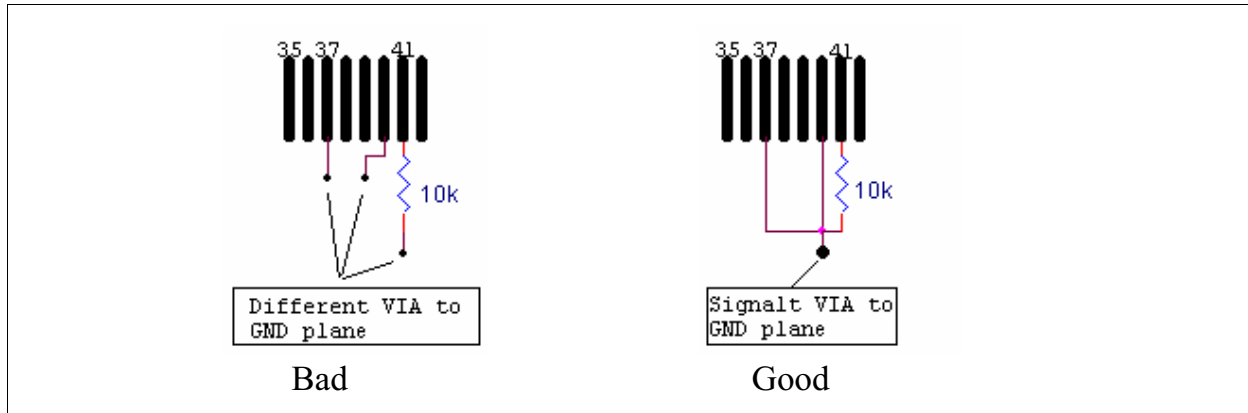

Figure 14 Power and Ground 3

www.infineon.com

Published by Infineon Technologies AG