

Interference Suppression film capacitors

PCX1 331

MKP RADIAL POTTED CAPACITORS

Pitch 15.0/22.5/27.5mm

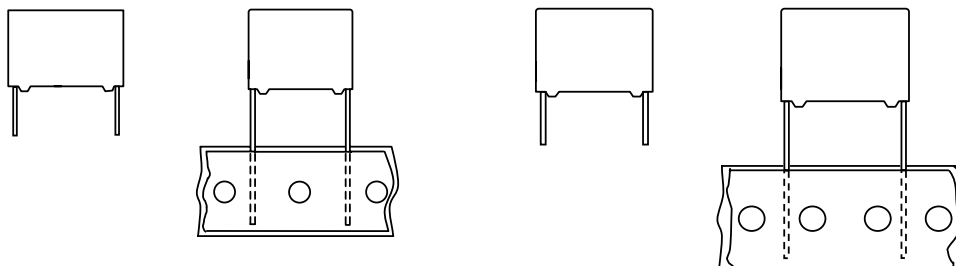

15mm

22.5 and 27.5mm

QUICK REFERENCE DATA

Capacitance range (E6 series) *	0.01 μ F to 1.0 μ F
Capacitance tolerance	$\pm 10\%$, $\pm 20\%$
Rated (AC) voltage 50 to 60 Hz	440 V $\bar{~}$
Climatic category	55/105/21
Temperature range	-55 ~ +105
Reference IEC specification	IEC 60384-14(3rd edition) and EN 60384-14
Safety approvals	UL 1414 & CSA-C22.2 No 1 (cUL) ENEC (SEMKO)
Potting & Encapsulation material	Qualified in accordance with UL 94V-0
Safety class	X1

* Intermediate values of the E12 series are available to special order

FEATURES	APPLICATIONS
<ul style="list-style-type: none"> . 15 to 27.5 mm lead pitch . Supplied loose in box and taped on reel . Consist of a low-inductive wound cell of Metallized Polypropylene film, potted in a flame retardant case 	<ul style="list-style-type: none"> . For X1-electromagnetic interference suppression . Specially designed to meet the NEW REQUIREMENTS in new IEC 60384-14 specification(3rd edition)/EN 60384-14 requiring for X1 a 4kV peak pulse voltage test and the UL1414 and CSA-C22.2 No. 1 specification

- Please refer to caution and warning at <http://www.pilkor.co.kr/download/Introductions.pdf> before using these products.

Ordering Information

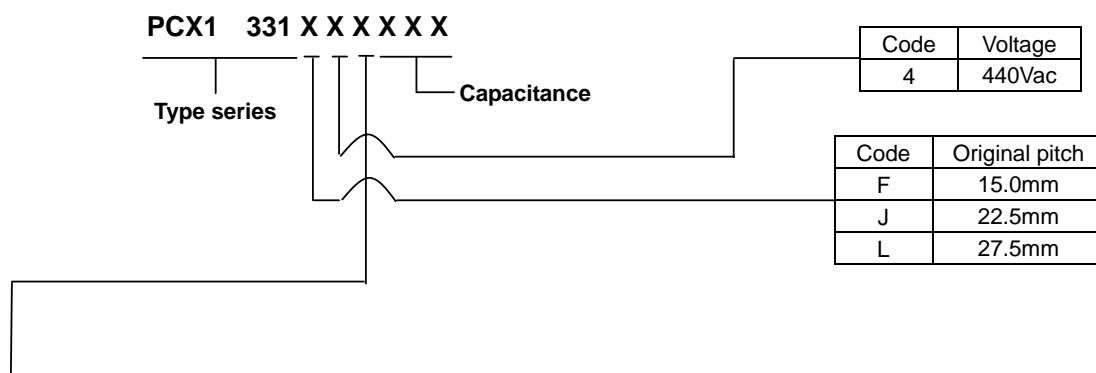
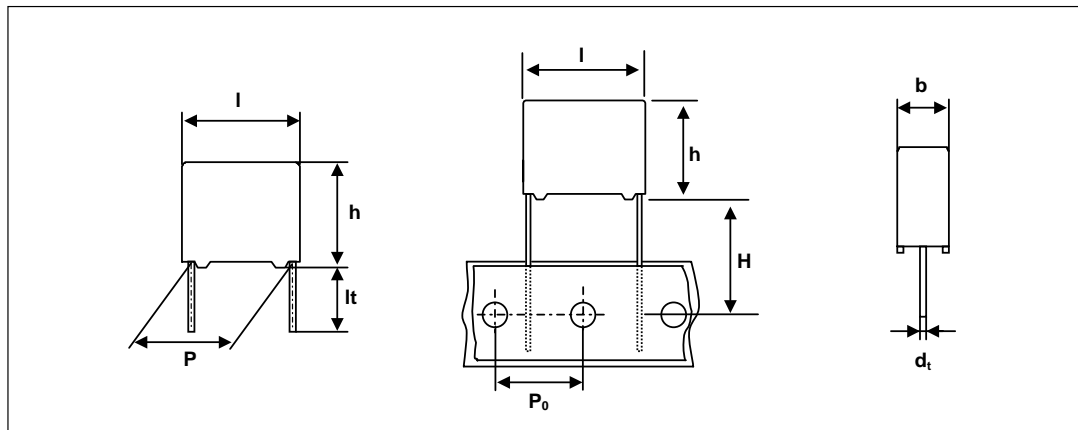

Available versions					Product (I_{max})			
code	Packing method	C - tol.	Lead length & Height	Hole to hole (P_0)	12.5	18.0	26.0	31.0
					Pitch (P)			
0	Loose in box	$\pm 20\%$	$lt = 5.0 \pm 1.0\text{mm}$	-	10.0	15.0	22.5	27.5
1	Loose in box	$\pm 10\%$	$lt = 5.0 \pm 1.0\text{mm}$	-	10.0	15.0	22.5	27.5
4	Loose in box	$\pm 20\%$	$lt = 25.0 \pm 2.0\text{mm}$	-	10.0	15.0	22.5	27.5
5	Loose in box	$\pm 10\%$	$lt = 25.0 \pm 2.0\text{mm}$	-	10.0	15.0	22.5	27.5
6	Ammopack	$\pm 20\%$	$H = 18.5\text{mm}$	12.7mm	10.0	15.0	22.5	27.5
7	Ammopack	$\pm 10\%$	$H = 18.5\text{mm}$	12.7mm	10.0	15.0	22.5	27.5

Interference Suppression film capacitors

PCX1 331

SAFETY APPROVALS

SAFETY APPROVALS	Voltage	Value	File Number
UL1414 & CSA 22.2 No 1	250V(AC)	10nF to 1uF	E165646
ENEC(SEMKO)*	440V(AC)	10nF to 1uF	SE/02566

* The ENEC-approval together with the CB-Certificate replace all national approval marks of the following countries(they have already signed the ENEC-Agreement): Austria; Belgium; Czech. Republic; Denmark; Finland; France; Germany; Greece; Hungary; Ireland; Italy; Luxembourg; Netherlands; Norway; Portugal; Slovenian; Spain; Sweden; Switzerland and United Kingdom

Packaging Information

SMALLEST PACKING QUANTITIES (SPQ)	LOOSE IN BOX	
	It = 5.0 ±1.0 mm	It = 25 ±2.0 mm
DIMENSIONS		
5.0 x 11.0 x 18.0	1000	1000
6.0 x 12.0 x 18.0	1000	1000
7.0 x 13.5 x 18.0	1000	1000
8.5 x 15.0 x 18.0	1000	1000
10.0 x 16.5 x 18.0	1000	1000
6.0 x 15.5 x 26.0	1000	1000
7.0 x 16.5 x 26.0	1000	1000
8.5 x 18.0 x 26.0	500	500
10.0 x 19.5 x 26.0	500	500
12.0 x 22.0 x 26.0	500	500
11.0 x 21.0 x 31.0	500	250
13.0 x 23.0 x 31.0	250	250
15.0 x 25.0 x 31.0	250	250
18.0 x 28.0 x 31.0	200	200
21.0 x 31.0 x 31.0	150	150

Interference Suppression film capacitors

PCX1 331

SPECIFIC REFERENCE DATA FOR 275 V_{AC}

Tangent of loss angle	at 1 kHz	at 10 kHz	at 100kHz
C = 470 nF	10×10^{-4}	20×10^{-4}	100×10^{-4}
C > 470 nF	20×10^{-4}	70×10^{-4}	-
Rated voltage pulse slope (dV/dt) _R P = 15.0 mm P = 22.5 mm P = 27.5 mm	250 V/us 150 V/us 100 V/us		
R between leads, for C = 0.33 uF at 100V 1min	> 15 000 M		
RC between leads, for C > 0.33 uF at 100V 1min	> 5000 s		
R between leads and case ; 100V 1min	> 30 000 M		
Withstanding(DC) Voltage (cut-off current 10mA)	3400 V ; 1 min		
Withstanding(AC) Voltage between leads and case	2400 V ; 1 min		

V_{Rac} = 440V~ X1

Cap. (uF)	b x h x l (mm)	MASS (g)	CATALOGUE NUMBER			
			PCX1 331			
			loose in box			
			lt = 5 ± 1.0 mm		lt = 25 ± 2.0 mm	
		C - tol ± 20 %	C - tol ± 10 %	C - tol ± 20 %	C - tol ± 10 %	
Pitch = 15.0 ± 0.4 mm d _t = 0.8 +0.08/-0.05 mm						
0.01	5.0 x 11.0 x 18.0	1.2	F40103	F41103	F44103	F45103
0.015	5.0 x 11.0 x 18.0	1.2	F40153	F41153	F44153	F45153
0.022	5.0 x 11.0 x 18.0	1.2	F40223	F41223	F44223	F45223
0.033	6.0 x 12.0 x 18.0	1.4	F40333	F41333	F44333	F45333
0.047	7.0 x 13.5 x 18.0	1.9	F40473	F41473	F44473	F45473
0.068	8.5 x 15.0 x 18.0	2.6	F40683	F41683	F44683	F45683
0.1	10.0 x 16.5 x 18.0	3.1	F40104	F41104	F44104	F45104
Pitch = 22.5 ± 0.4 mm d _t = 0.8 +0.08/-0.05 mm						
0.068	6.0 x 15.5 x 26.0	2.6	J40683	J41683	J44683	J45683
0.1	7.0 x 16.5 x 26.0	3.1	J40104	J41104	J44104	J45104
0.15	8.5 x 18.0 x 26.0	4.4	J40154	J41154	J44154	J45154
0.22	10.0 x 19.5 x 26.0	5.5	J40224	J41224	J44224	J45224
0.33	12.0 x 22.0 x 26.0	6.7	J40334	J41334	J44334	J45334
Pitch = 27.5 ± 0.4 mm d _t = 0.8 +0.08/-0.05 mm						
0.22	11.0 x 21.0 x 31.0	7.8	L40224	L41224	L44224	L45224
0.33	13.0 x 23.0 x 31.0	10.4	L40334	L41334	L44334	L45334
0.47	15.0 x 25.0 x 31.0	12.8	L40474	L41474	L44474	L45474
0.68	18.0 x 28.0 x 31.0	17.2	L40684	L41684	L44684	L45684
1.0	21.0 x 31.0 x 31.0	20.4	L40105	L41105	L44105	L45105

Original pitch	New Code	Old Code	Example
15.0mm	PCX1 331Fxxxx	PCX1 331 4xxxx	PCX1 331 45104 => PCX1 331F45104
22.5mm	PCX1 331Jxxxx	PCX1 331 5xxxx	
27.5mm	PCX1 331Lxxxx	PCX1 331 6xxxx	

CONSTRUCTION

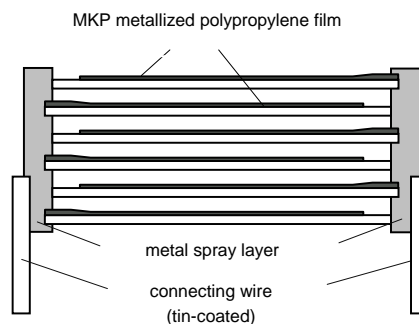

MOUNTING

NORMAL USE

The capacitors are designed for mounting on printed-circuit boards.

The capacitors packed in bandoliers are designed for mounting on printed-circuit boards by means of automatic insertion machines.

For detailed specifications refer to chapter "PACKAGING".

SPECIFIC METHOD OF MOUNTING TO WITHSTAND VIBRATION AND SHOCK

In order to withstand vibration and shock tests, it must be ensured that the stand-off pips are in good contact with the printed-circuit board.

- For pitches of 15mm the capacitors shall be mechanically fixed by leads.
- For larger pitches the capacitors shall be mounted in the same way and the body clamped.

SPACE REQUIREMENTS ON PRINTED-CIRCUIT BOARD

The maximum length and width of film capacitors are shown in the following drawing ;

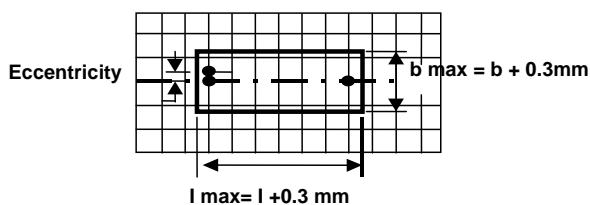

- Eccentricity as in drawing.
The maximum eccentricity is smaller than or equal to the lead diameter of the product concerned.
- Product height with seating plane as given by IEC 60717 as reference : $h_{max} \quad h + 0.3 \text{ mm}$

RATINGS AND CHARACTERISTICS

Unless otherwise specified all electrical values apply to an ambient temperature of 23 ± 1 , an atmospheric pressure of 86 to 106kPa and a relative humidity $50 \pm 2\%$.

For reference testing, a conditioning period shall be applied of 96 ± 4 hours by heating the products in a circulating air oven at the rated temperature and a relative humidity not exceeding 20%.

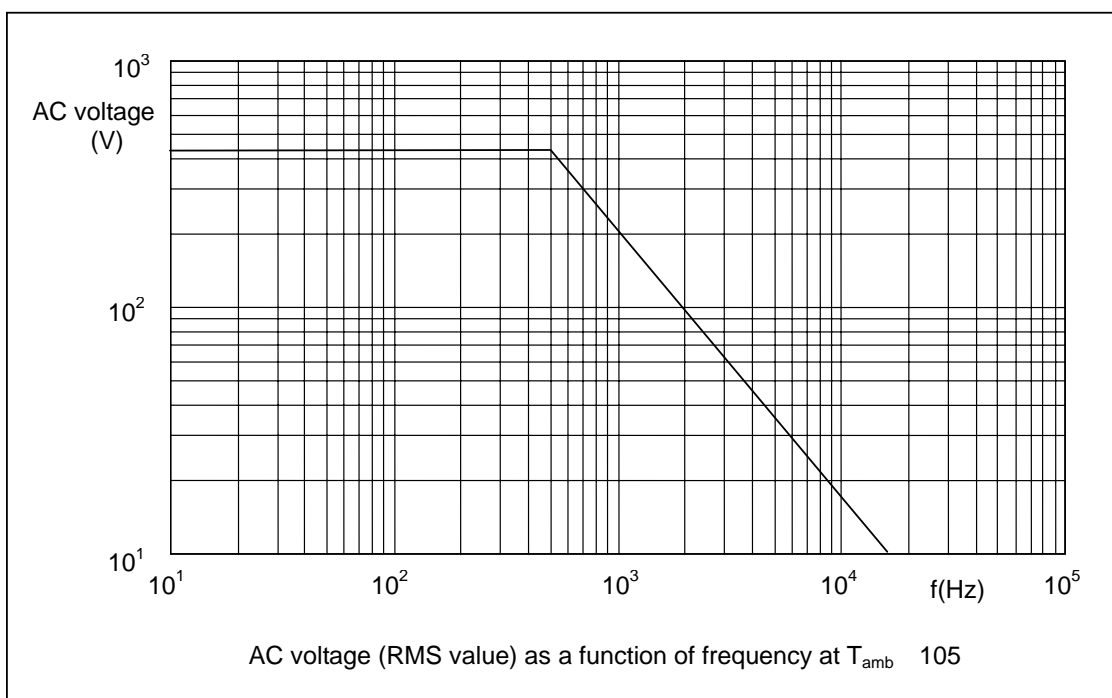
Maximum RMS Voltage as a function of frequency

PRODUCT MARKING

Capacitors are marked with the following information;

- 1.Manufacturer (PILKOR) for capacitors
- 2.Manufacturer's type designation (PCX1 331)
- 3.Rated capacitance in code according to IEC 60062
- 4.Rated (AC) voltage (440V~)
- 5.Sub class (X1)
- 6.Tolerance on rated capacitance M = $\pm 20\%$ K = $\pm 10\%$
- 7.Climatic category (55/105/21)
- 8.Code for dielectric material (MKP) for capacitors with original pitch
- 9.Year and week of manufacturing (0901)
- 10.Safety approvals

Example of marking :

Pitch P = 15mm or 22.5mm or 27.5mm

Head face

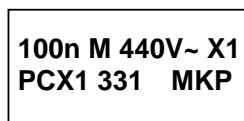

Side face

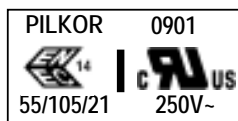

Pitch P = 22.5mm or 27.5mm

Head face

