

DATA SHEET

TDA1596T

**IF amplifier/demodulator for FM
radio receivers**

Product specification
File under Integrated Circuits, IC01

April 1991

IF amplifier/demodulator for FM radio receivers

TDA1596T

GENERAL DESCRIPTION

The TDA1596T provides IF amplification, symmetrical quadrature demodulation and level detection for quality home and car FM radio receivers and is suitable for both mono and stereo reception. It may also be applied to common front-ends, stereo decoders and AM receiver circuits.

Features

- Simulates behaviour of a ratio detector (internal field strength and detuning-dependent voltage for dynamic AF signal muting)
- Mono/stereo blend and field strength indication control voltage
- Three-state mode switch for FM, mute-on / FM, mute-off / FM-off
- Internal compensation of AF signal total harmonic distortion (THD)
- Two open collector stop pulse outputs for microcomputer tuning control (can be one stop pulse output by wired-ANDing)
- Internal reference voltage source
- Built-in hum and ripple rejection circuits.

QUICK REFERENCE DATA

SYMBOL	PARAMETER	CONDITIONS	MIN.	TYP.	MAX.	UNIT
V_P	Supply voltage (pin 1)		7.5	8.5	12.0	V
I_P	Supply current (pin 1)	$V_P = 8.5 \text{ V}; I_2 = I_7 = 0 \text{ mA}$	–	20	26	mA
$V_{4(rms)}$	AF output voltage (RMS value)	$V_{20(rms)} = 10 \text{ mV}$	180	200	220	mV
S/N	Signal-to-noise ratio	$V_{20(rms)} = 10 \text{ mV}; f_m = 400 \text{ Hz}; \Delta f = 75 \text{ kHz}$	–	82	–	dB
THD	Total harmonic distortion	$V_{20(rms)} = 10 \text{ mV}; f_m = 1 \text{ kHz}; I_7 = 0 \text{ mA}; \Delta f = 75 \text{ kHz}; \text{FM mute on}; \text{without de-emphasis}; \text{without detuning}$	–	0.1	0.3	%
T_{amb}	Operating ambient temperature range		–40	–	+ 85	°C

SEE ALSO DATA SHEET FOR TDA1596

PACKAGE OUTLINE

20-lead mini-pack; plastic (SO20; SOT163A); SOT163-1; 1996 August 12.

IF amplifier/demodulator for FM radio receivers

TDA1596T

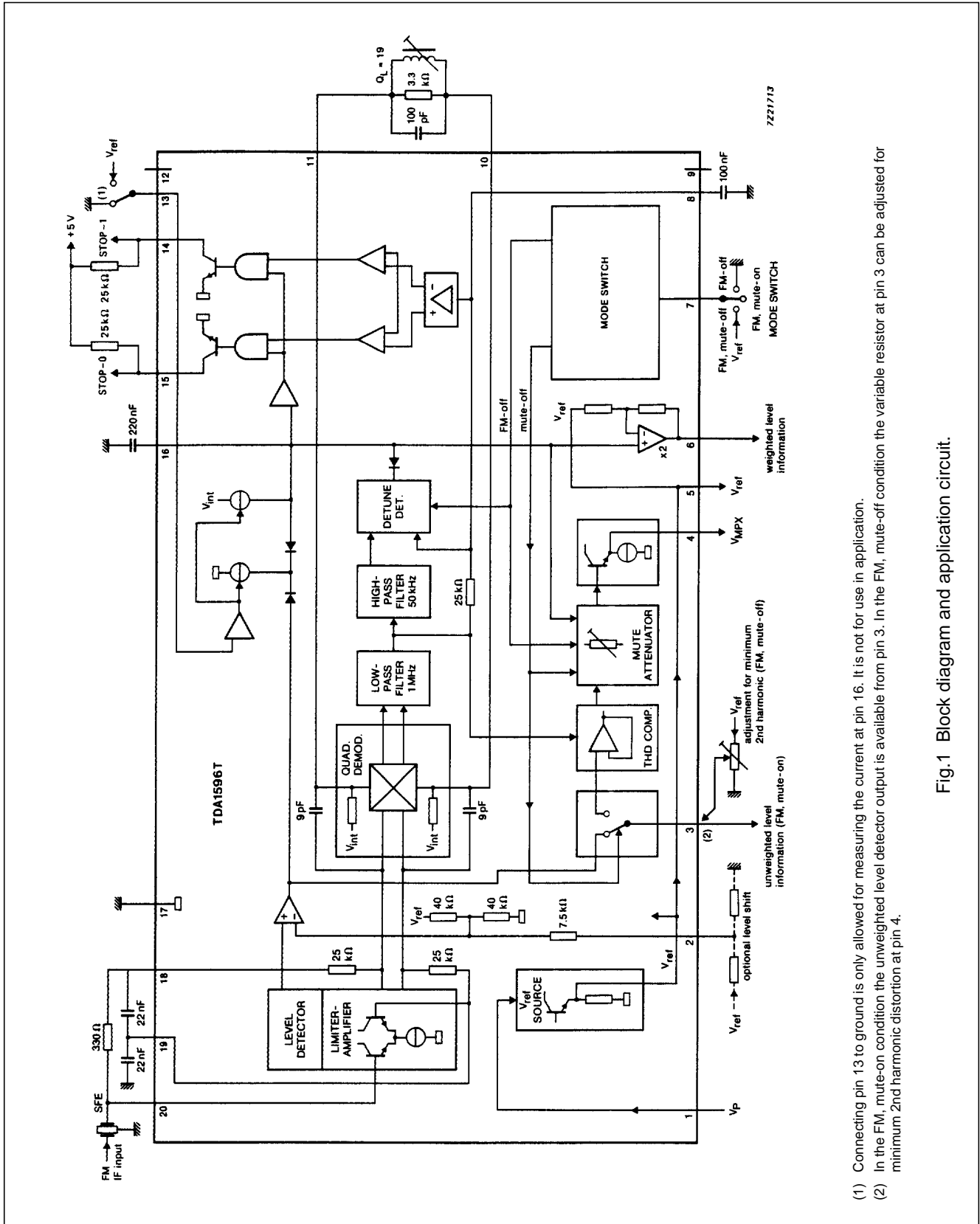

- (1) Connecting pin 13 to ground is only allowed for measuring the current at pin 16. It is not for use in application.
- (2) In the FM, mute-on condition the unweighted level detector output is available from pin 3. In the FM, mute-off condition the variable resistor at pin 3 can be adjusted for minimum 2nd harmonic distortion at pin 4.

Fig.1 Block diagram and application circuit.

IF amplifier/demodulator for FM radio receivers

TDA1596T

PINNING

1	V _P	supply voltage
2	LVA	level voltage adjustment
3	ULV	unweighted level output/K2 adjustment
4	AFO	AF output
5	V _{ref}	reference voltage output
6	WLV	weighted level voltage output
7	MSW	mode switch
8	DDV	detune detector voltage
9	n.c.	not connected
10	DMI1	demodulator input 1
11	DMI2	demodulator input 2
12	n.c.	not connected
13	TSW	tau switch
14	ST1	stop pulse output 1
15	ST0	stop pulse output 0
16	MTV	mute voltage
17	GND	ground
18	LFD1	IF limiter feedback 1
19	LFD2	IF limiter feedback 2
20	IFI	IF input

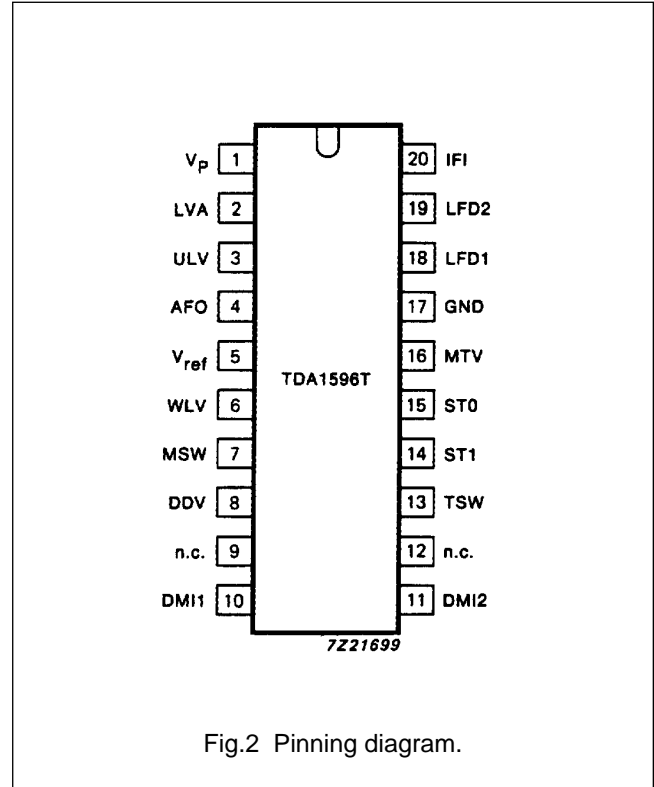

Fig.2 Pinning diagram.

IF amplifier/demodulator for FM radio receivers

TDA1596T

FUNCTIONAL DESCRIPTION

Limiter-amplifier

This has five stages of IF amplification using balanced differential limiter-amplifiers with emitter--follower coupling. Decoupling of the stages from the voltage supply lines and an internal high-ohmic DC feed-back loop give a very stable IF performance. The amplifier gain is virtually independent from temperature changes.

FM demodulator

The demodulator is fully balanced and comprises two cross-coupled differential amplifiers. Quadrature detection of the FM signal is performed by feeding one differential amplifier directly from the limiter--amplifier output, and the other via an external 90° phase-shifting network. The demodulator has good stability and its zero cross-over shift is small. The bandwidth of the demodulator output is restricted to approximately 1 MHz by an internal low-pass filter.

THD compensation

This circuit compensates non-linearities introduced by demodulation. For this to operate correctly the demodulator circuit between pins 10 and 11 must have a loaded Q-factor of 19. Consequently there is no need for the demodulator tuned circuit to be adjusted for minimum THD, instead the adjustment criterium is for a symmetrical stop pulse.

Mute attenuator and AF output

The control voltage for the mute attenuator at pin 16 is generated from the values of the level detector and the detuning detector outputs. The mute attenuator has a fast attack and a slow decay which is determined by the capacitor at pin 16. The AF signal is passed via the mute attenuator to the output at pin 4.

A weighted control voltage, available from pin 6, is obtained from the mute attenuator control voltage via a buffer-amplifier which introduces an additional voltage shift and gain.

Level detector

The level detector generates a voltage output which is proportional to the field strength of the input signal. The unweighted level detector output is available when the mode switch is operating in the FM, mute-on condition.

Tuning-stop outputs

The open collector outputs STOP-0 and STOP-1 (from pins 15 and 14 respectively) are voltages derived from the detuning level and the field strength of the input signal. If only one tuning-stop output is required, pins 14 and 15 may be tied together.

IF amplifier/demodulator for FM radio receivers

TDA1596T

RATINGS

Limiting values in accordance with the Absolute Maximum System (IEC 134)

SYMBOL	PARAMETER	MIN.	MAX.	UNIT
$V_P = V_{1-17}$	Supply voltage (pin 1)	-0.3	+16	V
V_{5-17}	Reference voltage range (pin 5)	-0.3	+ 10	V
V_{2-17}	Level adjustment range (pin 2)	-0.3	+ 10	V
V_{7-17}	Mode switch voltage range (pin 7)	-0.3	V_P	V
V_{13-17}	Control input voltage range (pin 13)	-	+ 6	V
V_{3-17}	THD compensation/unweighted field strength voltage range (pin 3)	-0.3	V_P	V
V_{15-17}	Tuning-stop output voltage range STOP-0 (pin 15)	-0.3	V_P	V
V_{14-17}	Tuning-stop output voltage range STOP-1 (pin 14)	-0.3	V_P	V
I_{15}	Tuning-stop output current STOP-0 (pin 15)	-	2	mA
I_{14}	Tuning-stop output current STOP-1 (pin 14)	-	2	mA
T_{stg}	Storage temperature range	-55	+ 150	°C
T_{amb}	Operating ambient temperature range	-40	+ 85	°C
	Electrostatic handling ⁽¹⁾			
V_{es}	all pins except pins 5 and 6	-2000	+ 2000	V
V_{es}	pin 5	-2000	+ 900	V
V_{es}	pin 6	-2000	+ 1600	V

Note

- Equivalent to discharging a 100 pF capacitor through a 1.5 kΩ series resistor.

THERMAL RESISTANCE

From junction to ambient (in free air)

$$R_{th\ j-a\ (max.)} = 95\ K/W$$

IF amplifier/demodulator for FM radio receivers

TDA1596T

CHARACTERISTICS

$f = 10.7$ MHz; $V_P = V_{1-17} = 8.5$ V; $V_I = V_{20(rms)} = 1$ mV; $T_{amb} = 25$ °C; measured in the circuit of Fig.3; tuned circuit at pins 10, 11 aligned for symmetrical stop pulses; all voltages are referred to ground (pin 17), unless otherwise specified

SYMBOL	PARAMETER	MIN.	TYP.	MAX.	UNIT
Supplies					
$V_P = V_1$	Supply voltage	7.5	8.5	12.0	V
I_1	Supply current at $I_2 = I_7 = 0$ mA	–	20	26	mA
FM demodulator					
R_{10-11}	Input impedance	25	40	55	k Ω
C_{10-11}		–	6	–	pF
V_4	DC output voltage (no-signal condition) at $V_{10, 11(p-p)} \leq 100$ μ V; $V_{20(rms)} \leq 5$ μ V	2.75	3.10	3.45	V
R_{4-17}	Output impedance	–	400	–	Ω
Mute attenuator control voltage					
V_{16}	Control voltage (pin 16) at $V_{20(rms)} \leq 5$ μ V	–	2.0	–	V
V_{16}	at $V_{20(rms)} = 1$ mV	–	3.45	–	V
R_{10-17}	Output impedance (pin 16)	–	–	2.0	M Ω
V_2	Level shift input (pin 2) internal bias voltage at $I_2 = 0$ mA	–	1.4	–	V
R_{2-17}	input impedance	15	–	–	k Ω
Internal muting (Fig.6)					
	Internal attenuation of signals ± 22.5 kHz \leq detuning $\leq \pm 80$ kHz; $A = 20\log[\Delta V_4(\text{FM mute-off})/\Delta V_4(\text{FM})]$				
A	at $V_{16} \geq 1 V_5$	–	0	–	dB
A	at $V_{16} = 0.77 V_5$	1.5	3.0	4.5	dB
A	at $V_{16} = 0.55 V_5$	–	20	–	dB

IF amplifier/demodulator for FM radio receivers

TDA1596T

SYMBOL	PARAMETER	MIN.	TYP.	MAX.	UNIT
Attack and decay (pin 16)					
$+I_{16}$	Pin 13 connected to ground * charge current	–	8	–	μA
$-I_{16}$	discharge current	–	120	–	μA
$+I_{16}$	Pin 13 connected to V_{ref} charge current	–	100	–	μA
$-I_{16}$	discharge current	–	120	–	μA
Level detector					
$\frac{\Delta V_6}{V_6 \Delta T}$	Dependence of output voltage on temperature	–	3.3	–	mV/VK
R_6	Output impedance	–	–	500	Ω
V_6	Dependence of output voltage (pin 6) on input voltage (pin 20) (Fig.7): $V_{20(\text{rms})} \leq 5 \mu\text{V}; I_2 = I_7 = 0 \text{ mA}$	0.1	0.7	1.3	V
V_6	$V_{20(\text{rms})} = 1 \text{ mV}; I_2 = I_7 = 0 \text{ mA}$	3.0	3.6	4.2	V
$\frac{\Delta V_6}{20 \Delta \log V_{20}}$	Slope of output voltage (pin 6) for input voltage range $V_{20(\text{rms})} \geq 50 \mu\text{V}$ to $V_{20(\text{rms})} \leq 50 \text{ mV}$	1.4	1.7	2.0	V/20 dB
ΔV_6	Dependence of output voltage (pin 6) on detuning (Fig.8) at input voltage $V_{20(\text{rms})} = 10 \text{ mV}$: detuning = $\leq \pm 45 \text{ kHz}$	–	–	0.2	V
$\pm \Delta f$	detuning for $V_6 = 1.8 \text{ V}$	90	–	160	kHz
V_6	detuning = $\pm 200 \text{ kHz}$	0.5	0.7	0.9	V
$ \Delta V_6 / \Delta f $	Slope of output voltage with detuning = $125 \pm 20 \text{ kHz}$ at $V_{20(\text{rms})} = 10 \text{ mV}$	–	35	–	mV/kHz
$\pm \Delta V_6$	Level shift control (pin 2) (Fig.9) adjustment range	1.6	2.0	–	V
$-(\Delta V_6 / \Delta V_2)$	adjustment gain	–	1.7	–	V
V_6	output voltage at $V_2 = V_5; V_{20(\text{rms})} \leq 5 \mu\text{V}$	–	–	0.3	V
Low-pass filter at pin 8					
V_8	Output voltage at $I_7 = 0 \text{ mA}$; $V_{20(\text{rms})} \leq 5 \mu\text{V}$	–	2.2	–	V
$R_{8(\text{int})}$	Internal resistance	12	25	50	k Ω

IF amplifier/demodulator for FM radio receivers

TDA1596T

SYMBOL	PARAMETER	MIN.	TYP.	MAX.	UNIT
Tuning-stop detector (Figs 10 and 11)					
+ Δf	Stop-0: detuning at $V_{20(rms)} = 10$ mV for $V_{15} \geq 3.5$ V	–	–	10	kHz
+ Δf	for $V_{15} \leq 0.3$ V	18	–	–	kHz
– Δf	Stop-1: detuning at $V_{20(rms)} = 10$ mV for $V_{14} \geq 3.5$ V	–	–	10	kHz
– Δf	for $V_{14} \leq 0.3$ V	18	–	–	kHz
$V_{20(rms)}$	Dependence of STOP-0, STOP-1 on input voltage (pin 20) input voltage (RMS value) for $V_{14} = V_{15} \geq 3.5$ V	250	–	–	μ V
$V_{20(rms)}$	input voltage (RMS value) for $V_{14} = V_{15} \leq 0.3$ V	–	–	50	μ V
$V_{14, 15}$	Output voltage when $I_{14} = I_{15} = 1$ mA	–	–	0.3	V
Mode switch and pin 3 (Fig.12)					
<i>FM-off position</i>					
V_7	Control voltage for 60 dB muting depth	–	–	1.4	V
<i>FM, mute-on position (pin 3 = output)</i>					
V_7	Internal bias voltage at $R_{7-17} \geq 10$ M Ω	–	2.8	–	V
$ I_7 $	Input current	–	–	2.5	μ A
V_3	Output voltage with $R_{3-17} = 10$ k Ω ; $C_{3-17} \geq 1$ nF*	–	2	–	V
R_{3-17}	Output impedance for $V_{20} = \leq 5$ μ V; $I_3 = 500$ μ A	–	–	100	Ω
<i>FM, mute-off position (pin 3 = input)</i>					
V_7	Control voltage	$0.9 V_5$	–	–	V
I_7	Input current at $V_7 = V_5$	–	–	15	μ A
R_{3-17}	Input resistance	1	–	–	M Ω
Reference voltage source					
V_5	Output voltage at $I_5 = -1$ mA	3.3	3.7	4.1	V
$\Delta V_5/I_5$	Output impedance at $I_5 = -1$ mA	–	40	80	Ω
TC	Temperature coefficient	–	3.3	–	mV/K

* Connecting pin 13 to ground is only allowed for measuring the current at pin 16. It is not for use in application.

* Without input voltage.

IF amplifier/demodulator for FM radio receivers

TDA1596T

OPERATING CHARACTERISTICS

f = 10.7 MHz; $V_1 = V_{20(rms)} = 1$ mV; deviation (Δf) = 22.5 kHz; modulation frequency (f_m) = 400 Hz; de-emphasis (pin 4) = 50 μ s; test circuit as per Fig.3; tuned circuit ($Q_L = 19$) aligned for symmetrical stop pulses; $T_{amb} = +25$ °C; unless otherwise specified

SYMBOL	PARAMETER	MIN.	TYP.	MAX.	UNIT
$V_{4(rms)}$	AF output voltage (RMS value) at $V_{20(rms)} = 10$ mV	180	200	220	mV
$V_{20(rms)}$	Start of limiting (FM, mute-off); (RMS value) (Fig.13)	14	22	35	μ V
	Dependence of signal-to-noise ratio (in noise frequency band 250 Hz to 15 kHz, unweighted) on input voltage				
$V_{18(rms)}$	for S/N = 26 dB	–	15	–	μ V
$V_{18(rms)}$	for S/N = 46 dB	–	60	–	μ V
S/N	at $V_{20(rms)} = 10$ mV; $\Delta f = 75$ kHz	–	82	–	dB
THD	THD (FM, mute-on) at $V_{20(rms)} = 10$ mV; $\Delta f = 75$ kHz; $f_m = 1$ kHz; without detuning; without de-emphasis; $I_7 = 0$ mA	–	0.1	0.3	%
α_D	Dynamic mute attenuation (Fig.14)	–	16	–	dB
	$\alpha_D = 20 \log \frac{V_4 \text{ (FM mute - off)}}{V_4 \text{ (FM, mute-on)}}$				
	with $f_m = 100$ kHz; $\Delta f = 75$ kHz				
$\alpha_D \Delta f$	Slope of attenuation curve	–	0.8	–	dB/kHz
	THD (FM, mute-on) at $V_{20(rms)} = 10$ mV; $\Delta f = 75$ kHz; $f_m = 1$ kHz; detuning $\leq \pm 25$ kHz without de-emphasis; $I_7 = 0$ mA (Fig.15)	–	–	0.6	%
THD	THD (FM, mute-off and compensated via pin 3) at $V_{20(rms)} = 10$ mV; $\Delta f = 75$ kHz; $f_m = 1$ kHz;	–	–	–	–
THD	$V_7 = V_5$	–	0.07	0.25	%
V_3	Voltage range at pin 3 for THD compensation	0	–	V_5	V
	AM suppression (FM, mute-off) with amplitude modulation at 30% input voltage range $V_{20} = 300$ μ V to 100 mV (Fig.16)	–	65	–	dB
	Power supply ripple rejection = $20 \log [\Delta V_1 / \Delta V_4]$	33	36	–	dB
	Mute attenuation (FM-off) = $20 \log [V_{4(FM-on)} / V_{4(FM-off)}]$	60	–	–	dB

IF amplifier/demodulator for FM radio receivers

TDA1596T

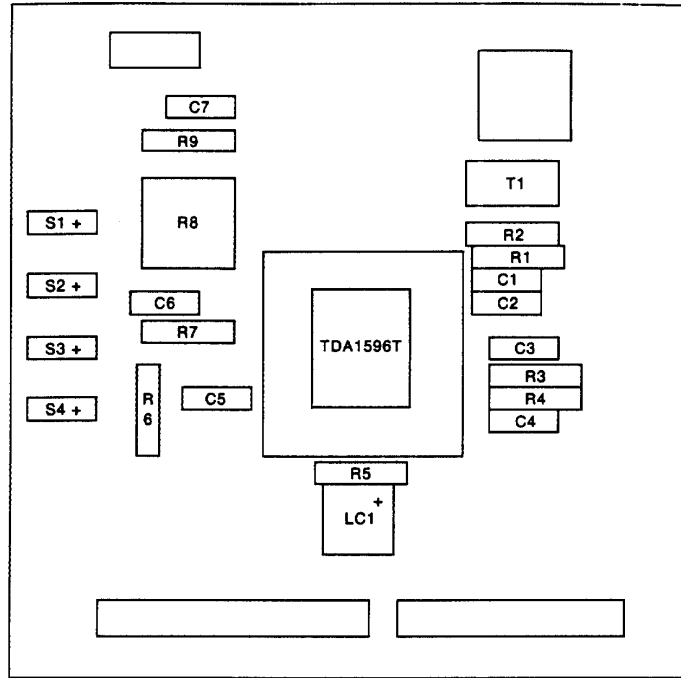

7221700

Fig.4 Printed-circuit board component side, showing component layout. For circuit diagram see Fig.3.

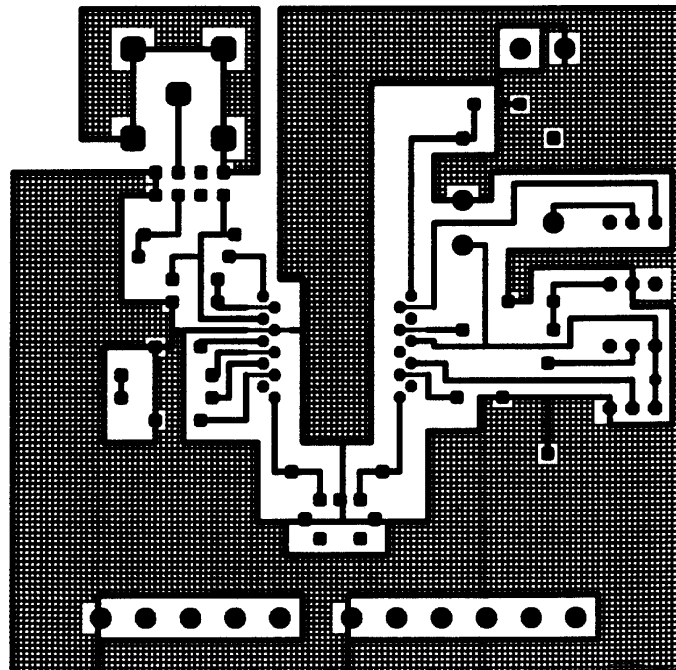

7221701

Fig.5 Printed-circuit board showing track side.

IF amplifier/demodulator for FM radio receivers

TDA1596T

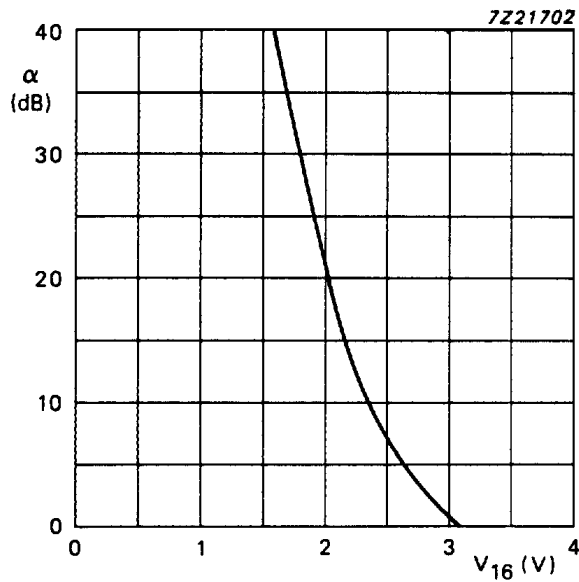

Fig.6 Typical curve of internal attenuation showing the relationship between the mute attenuator control voltage (pin 16) and mute attenuation; $I_2 = I_7 = 0$ mA

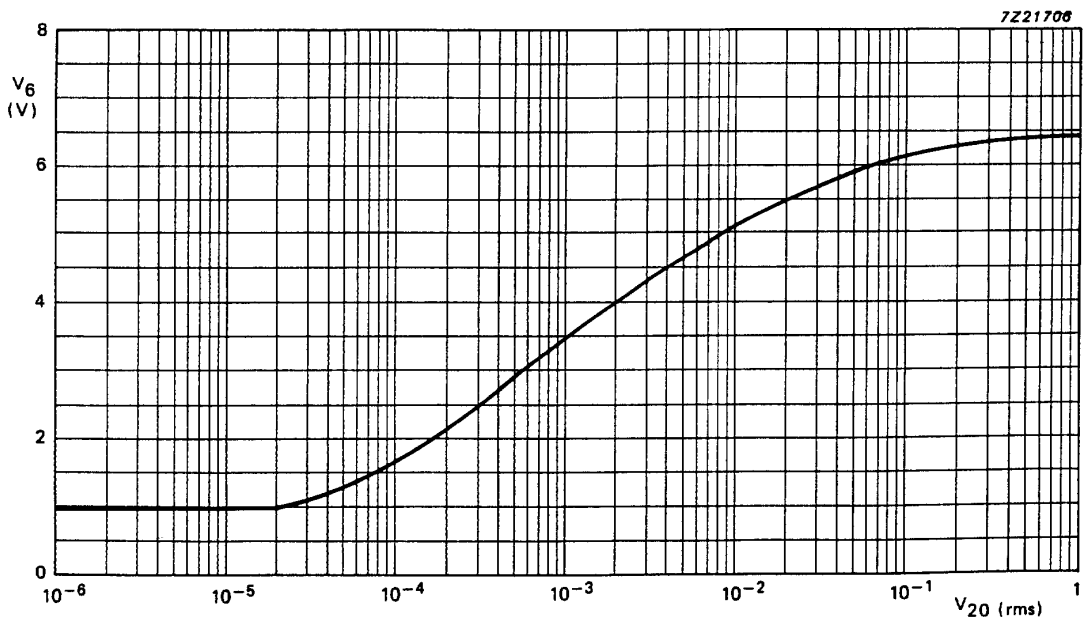

Fig.7 Weighted field strength output voltage (pin 6) as a function of input voltage (pin 20); $R_{6-17} \geq 10$ k Ω ; $I_2 = I_7 = 0$ mA.

IF amplifier/demodulator for FM radio receivers

TDA1596T

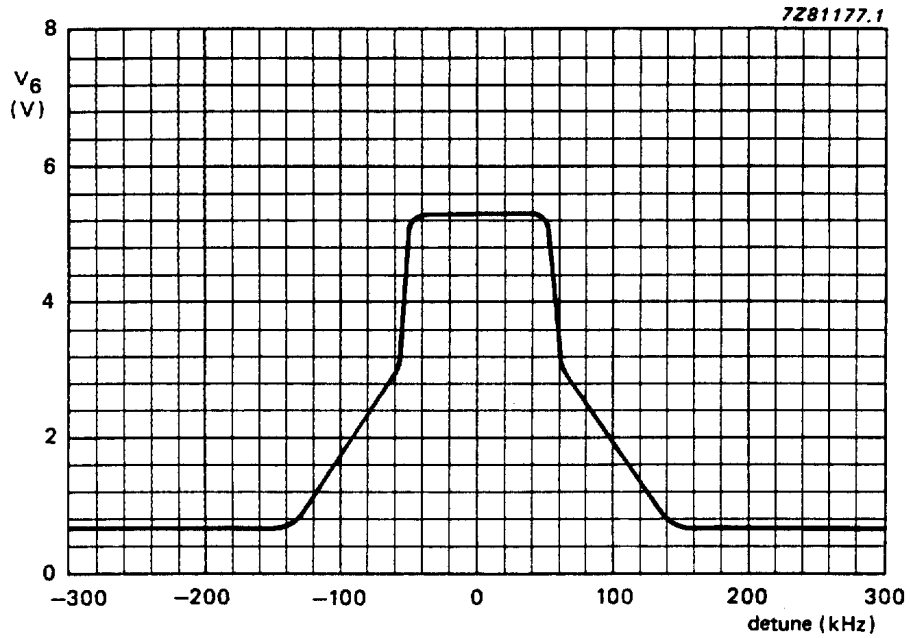

Fig.8 Weighted field strength output voltage (pin 6) as a function of detuning; $R_{6-17} \geq 10 \text{ k}\Omega$; $I_2 = I_7 = 0 \text{ mA}$; $V_{20} = 10 \text{ mV}$.

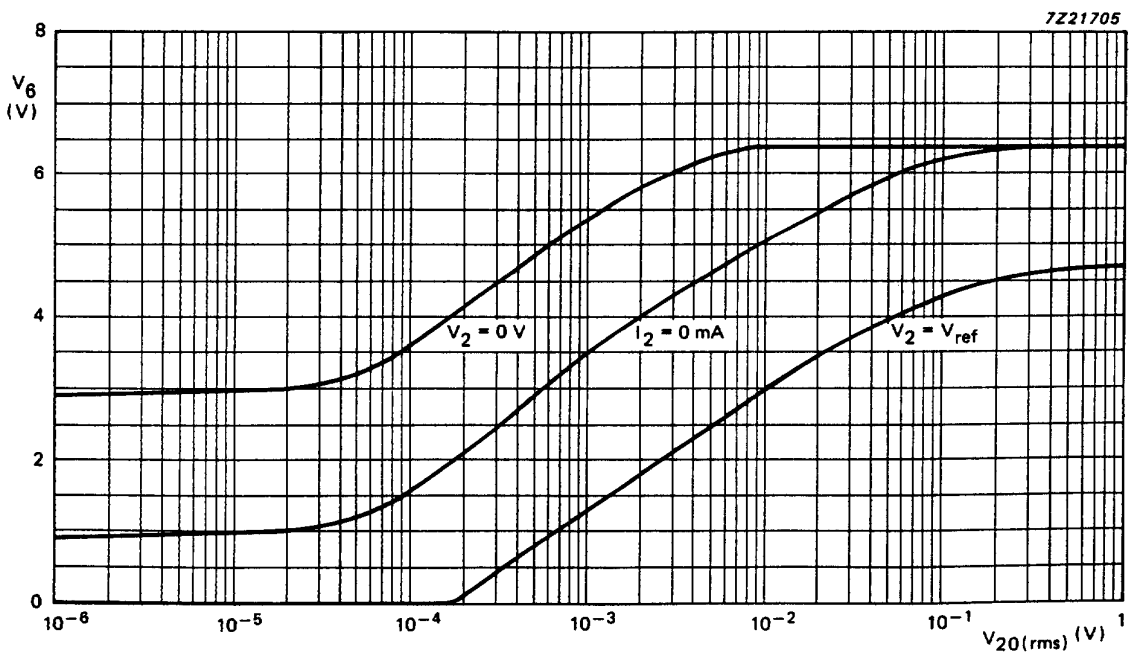
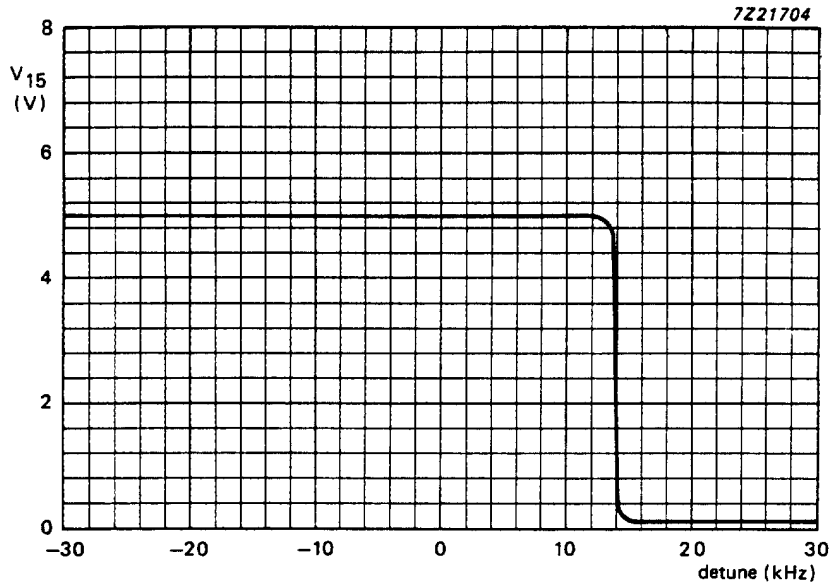

Fig.9 Adjustment range of weighted field strength output voltage (pin 6) with level shift control (pin 2); $R_{6-17} \geq 10 \text{ k}\Omega$; $I_7 = 0 \text{ mA}$.

IF amplifier/demodulator for FM radio receivers

TDA1596T



(a) STOP-0.

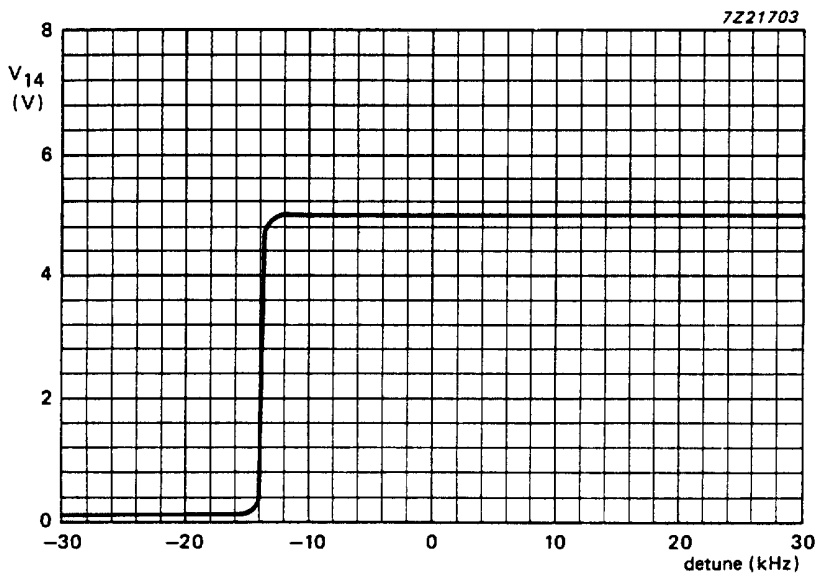

(b) STOP-1.

Fig.10 STOP-0 and STOP-1 output voltages as a function of detuning, measured at V₂₀ = 10 mV.

IF amplifier/demodulator for FM radio receivers

TDA1596T

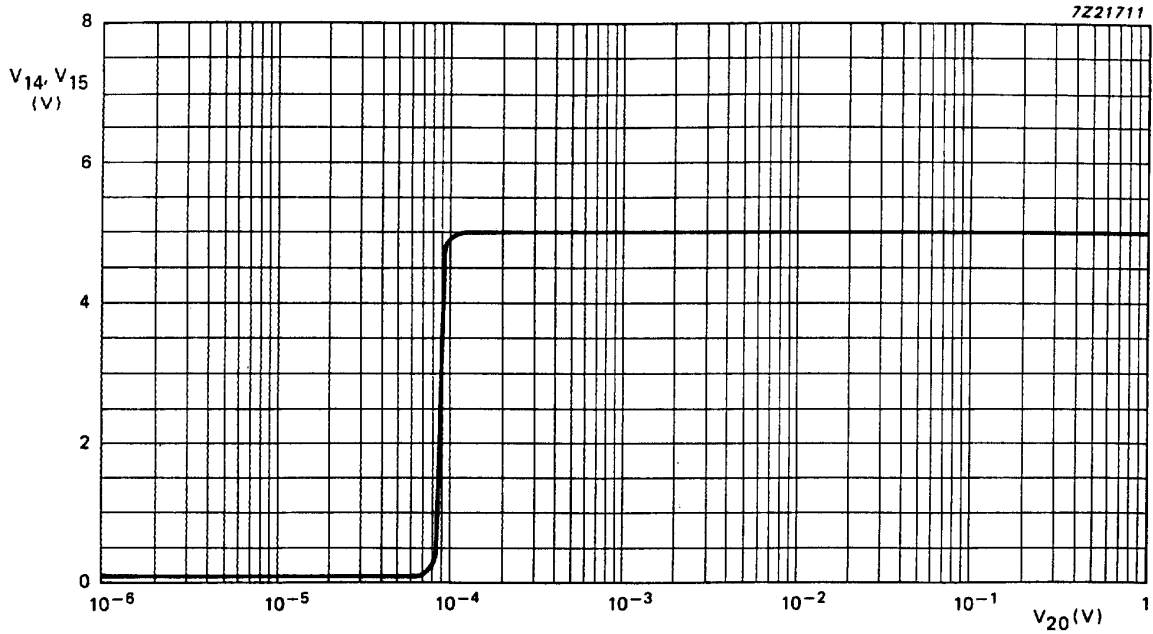

Fig.11 STOP-0 or STOP-1 output voltages as a function of input voltage at pin 20.

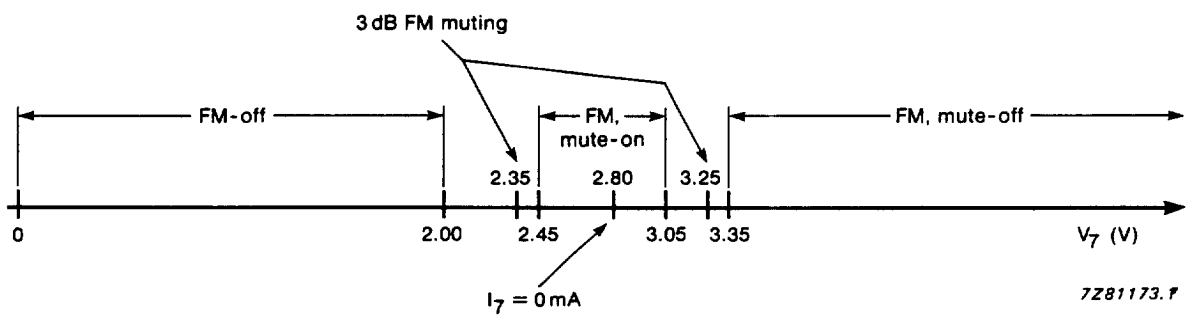
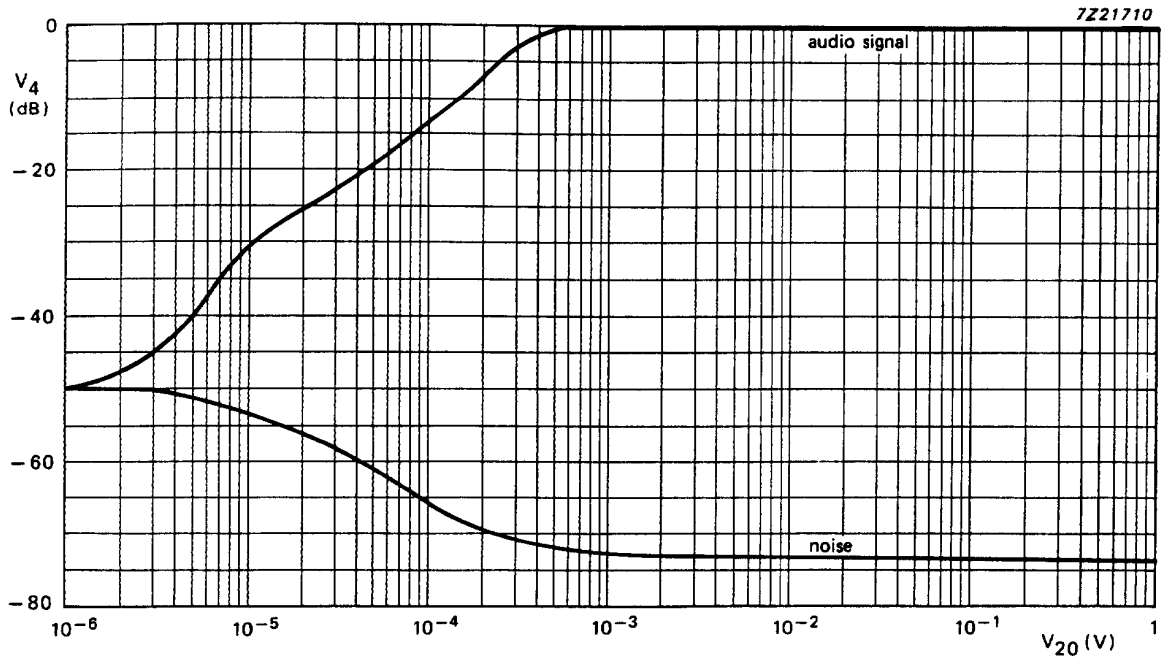

Fig.12 Switch levels at pin 7.

IF amplifier/demodulator for FM radio receivers

TDA1596T



(a) mode switch at FM, mute-on

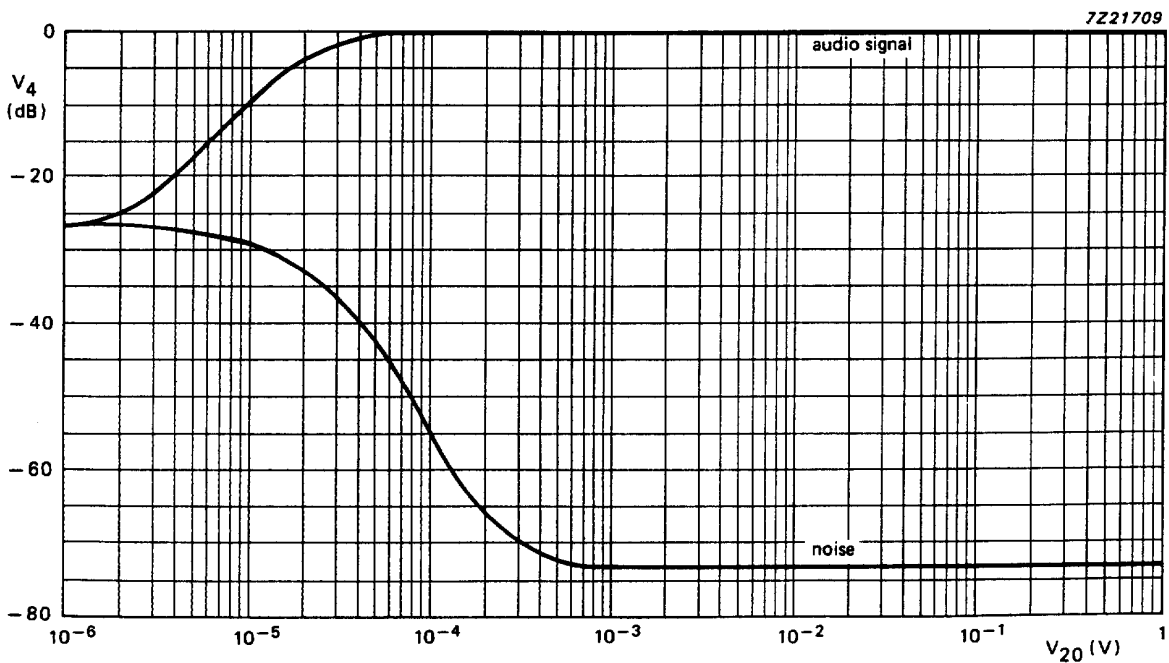

(b) mode switch at FM, mute-off

Fig.13 Audio signal ($\Delta f = 22.5$ kHz; $f_m = 1$ kHz) and noise as functions of input voltage at pin 20; measured with $50 \mu s$ de-emphasis.

IF amplifier/demodulator for FM radio receivers

TDA1596T

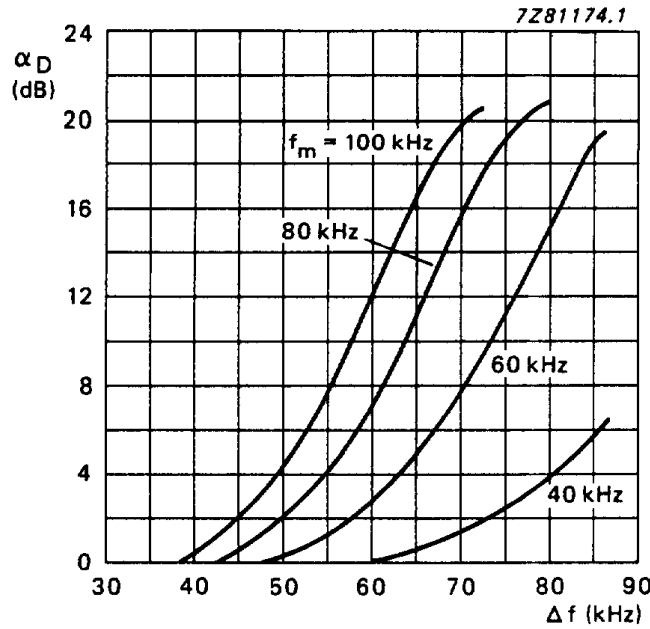

Fig.14 Dynamic mute attenuation as a function of frequency deviation for modulation frequencies of 40, 60, 80 and 100 kHz.

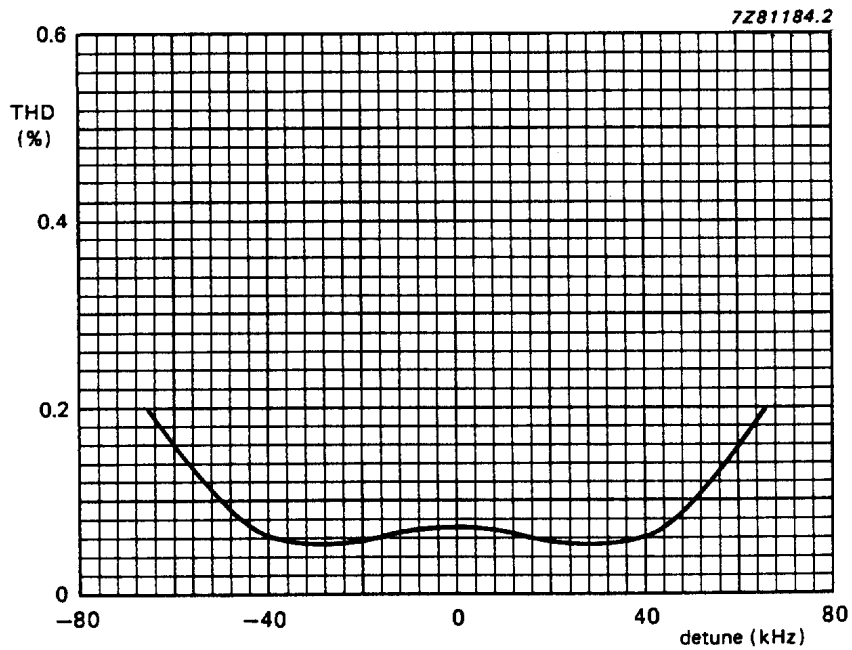
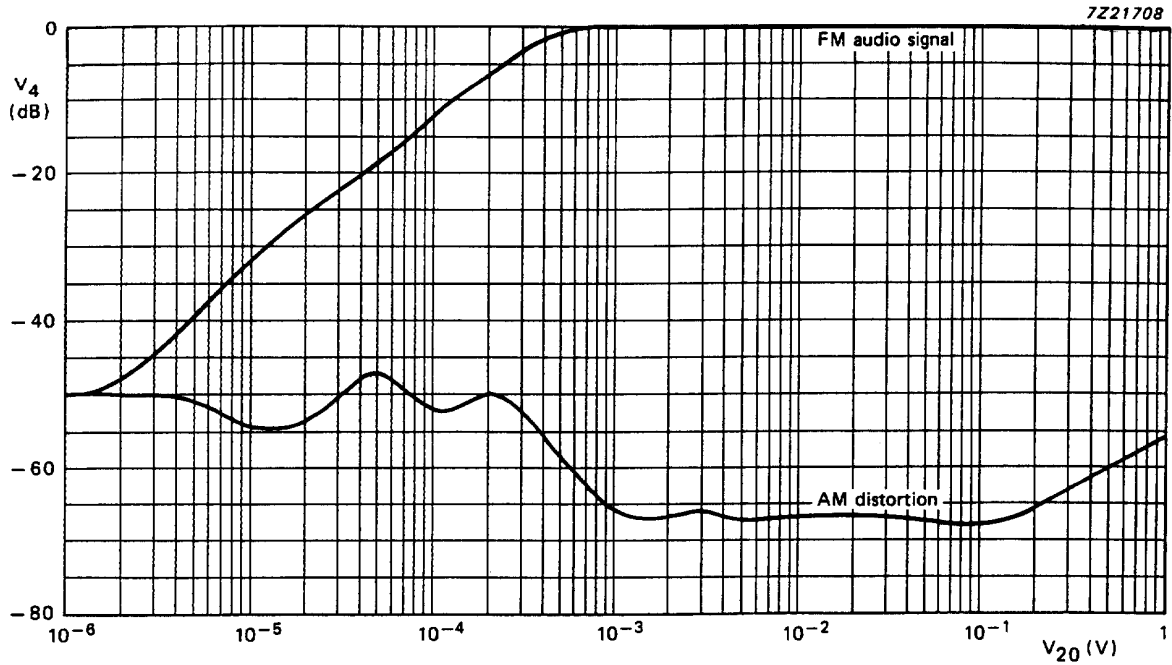

Fig.15 THD as a function of detuning, mode switch at FM, mute-on position; $\Delta f = 75$ kHz; $f_m = 1$ kHz; $V_{20(rms)} = 10$ mV.

IF amplifier/demodulator for FM radio receivers

TDA1596T



(a) mode switch at FM, mute-on

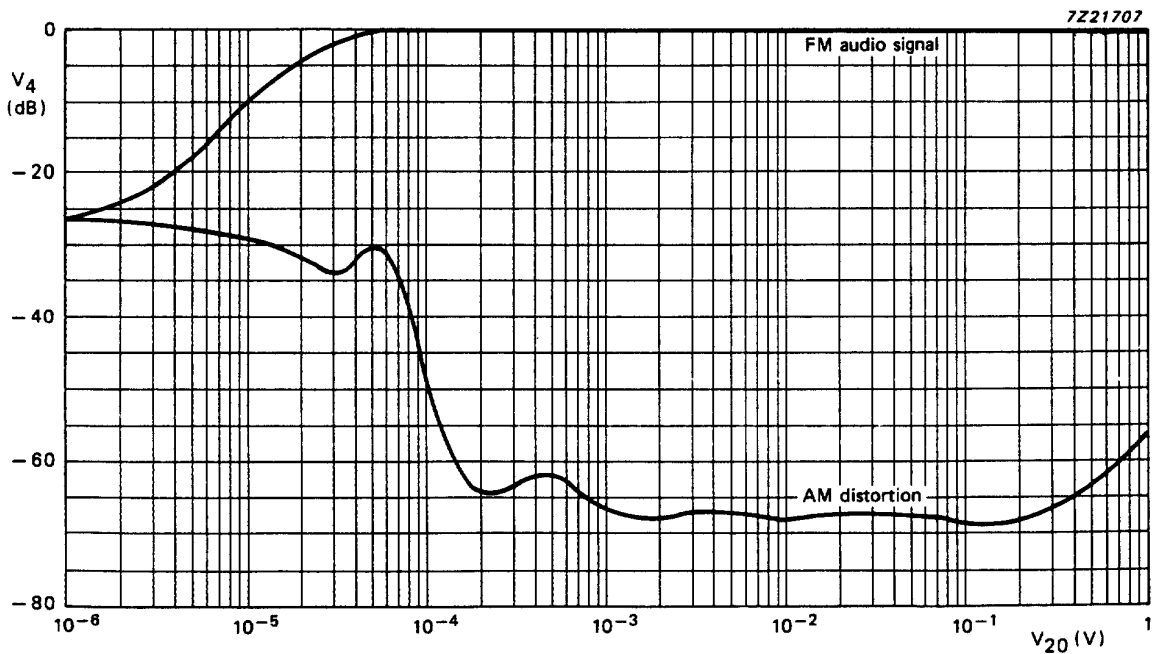

(b) mode switch at FM, mute-off

Fig.16 Typical curves showing AM suppression for an input signal having frequency modulation at $\Delta f = 22.5$ kHz and $f_m = 1$ kHz, and amplitude modulation of 30% at a frequency of 400 Hz; de-emphasis time = $50 \mu s$ and bandwidth = 250 Hz to 15 kHz.

IF amplifier/demodulator for FM radio receivers

TDA1596T

PACKAGE OUTLINE

SO20: plastic small outline package; 20 leads; body width 7.5 mm

SOT163-1

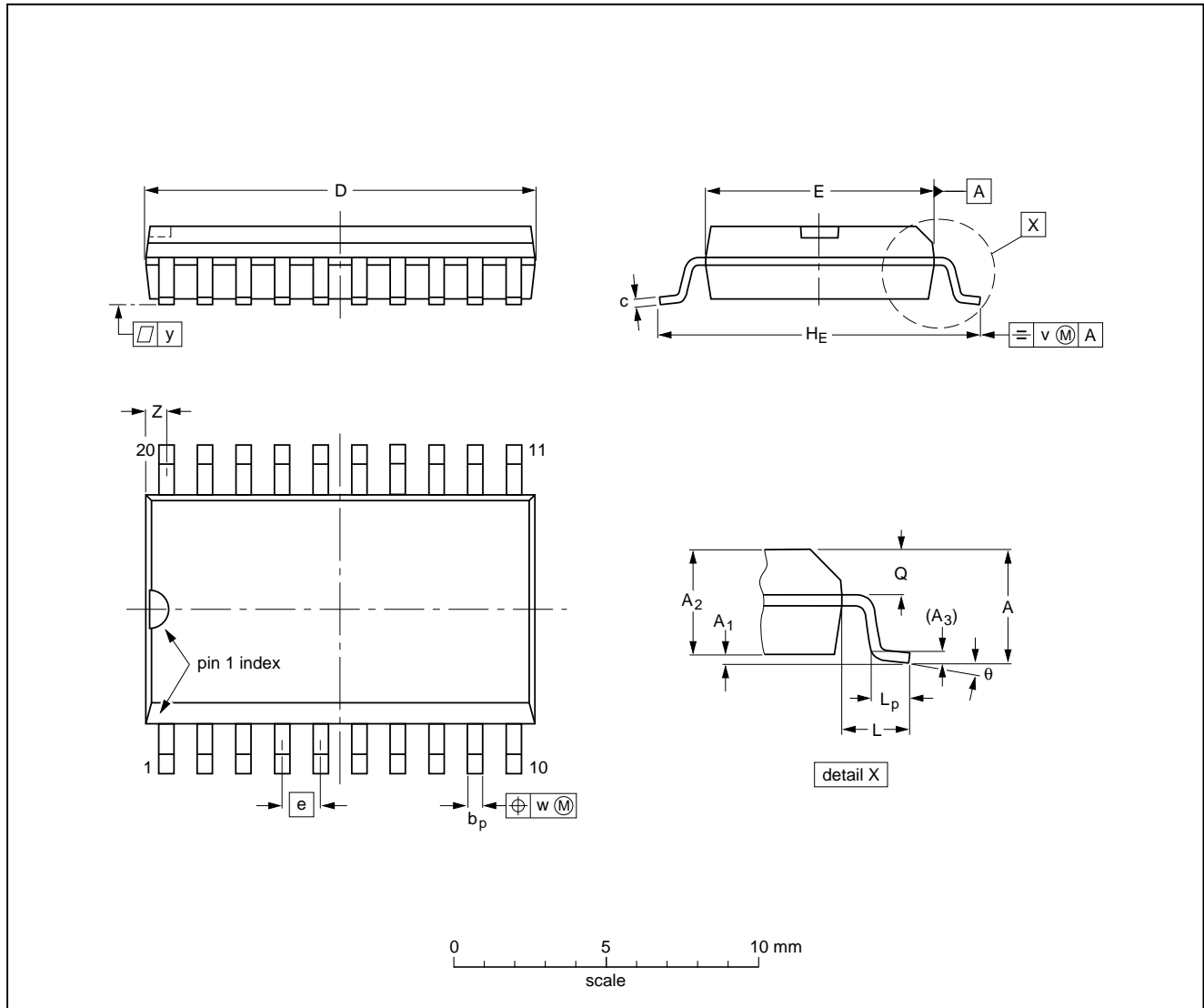

DIMENSIONS (inch dimensions are derived from the original mm dimensions)

UNIT	A max.	A ₁	A ₂	A ₃	b _p	c	D ⁽¹⁾	E ⁽¹⁾	e	H _E	L	L _p	Q	v	w	y	Z ⁽¹⁾	θ
mm	2.65	0.30 0.10	2.45 2.25	0.25	0.49 0.36	0.32 0.23	13.0 12.6	7.6 7.4	1.27	10.65 10.00	1.4	1.1 0.4	1.1 1.0	0.25	0.25	0.1	0.9 0.4	8° 0°
inches	0.10	0.012 0.004	0.096 0.089	0.01	0.019 0.014	0.013 0.009	0.51 0.49	0.30 0.29	0.050	0.42 0.39	0.055	0.043 0.016	0.043 0.039	0.01	0.01	0.004	0.035 0.016	

Note

1. Plastic or metal protrusions of 0.15 mm maximum per side are not included.

OUTLINE VERSION	REFERENCES				EUROPEAN PROJECTION	ISSUE DATE
	IEC	JEDEC	EIAJ			
SOT163-1	075E04	MS-013AC				92-11-17 95-01-24

IF amplifier/demodulator for FM radio receivers

TDA1596T

SOLDERING

Introduction

There is no soldering method that is ideal for all IC packages. Wave soldering is often preferred when through-hole and surface mounted components are mixed on one printed-circuit board. However, wave soldering is not always suitable for surface mounted ICs, or for printed-circuits with high population densities. In these situations reflow soldering is often used.

This text gives a very brief insight to a complex technology. A more in-depth account of soldering ICs can be found in our "*IC Package Databook*" (order code 9398 652 90011).

Reflow soldering

Reflow soldering techniques are suitable for all SO packages.

Reflow soldering requires solder paste (a suspension of fine solder particles, flux and binding agent) to be applied to the printed-circuit board by screen printing, stencilling or pressure-syringe dispensing before package placement.

Several techniques exist for reflowing; for example, thermal conduction by heated belt. Dwell times vary between 50 and 300 seconds depending on heating method. Typical reflow temperatures range from 215 to 250 °C.

Preheating is necessary to dry the paste and evaporate the binding agent. Preheating duration: 45 minutes at 45 °C.

Wave soldering

Wave soldering techniques can be used for all SO packages if the following conditions are observed:

- A double-wave (a turbulent wave with high upward pressure followed by a smooth laminar wave) soldering technique should be used.
- The longitudinal axis of the package footprint must be parallel to the solder flow.
- The package footprint must incorporate solder thieves at the downstream end.

During placement and before soldering, the package must be fixed with a droplet of adhesive. The adhesive can be applied by screen printing, pin transfer or syringe dispensing. The package can be soldered after the adhesive is cured.

Maximum permissible solder temperature is 260 °C, and maximum duration of package immersion in solder is 10 seconds, if cooled to less than 150 °C within 6 seconds. Typical dwell time is 4 seconds at 250 °C.

A mildly-activated flux will eliminate the need for removal of corrosive residues in most applications.

Repairing soldered joints

Fix the component by first soldering two diagonally-opposite end leads. Use only a low voltage soldering iron (less than 24 V) applied to the flat part of the lead. Contact time must be limited to 10 seconds at up to 300 °C. When using a dedicated tool, all other leads can be soldered in one operation within 2 to 5 seconds between 270 and 320 °C.

IF amplifier/demodulator for FM radio receivers

TDA1596T

DEFINITIONS

Data sheet status	
Objective specification	This data sheet contains target or goal specifications for product development.
Preliminary specification	This data sheet contains preliminary data; supplementary data may be published later.
Product specification	This data sheet contains final product specifications.
Limiting values	
Limiting values given are in accordance with the Absolute Maximum Rating System (IEC 134). Stress above one or more of the limiting values may cause permanent damage to the device. These are stress ratings only and operation of the device at these or at any other conditions above those given in the Characteristics sections of the specification is not implied. Exposure to limiting values for extended periods may affect device reliability.	
Application information	
Where application information is given, it is advisory and does not form part of the specification.	

LIFE SUPPORT APPLICATIONS

These products are not designed for use in life support appliances, devices, or systems where malfunction of these products can reasonably be expected to result in personal injury. Philips customers using or selling these products for use in such applications do so at their own risk and agree to fully indemnify Philips for any damages resulting from such improper use or sale.