

DATA SHEET



PCF8535

65 × 133 pixel matrix driver

Product specification
Supersedes data of 1999 Aug 24
File under Integrated Circuits, IC12

2001 Nov 07

65 × 133 pixel matrix driver**PCF8535****CONTENTS**

1	FEATURES	7.14	Voltage multiplier control
2	APPLICATIONS	7.14.1	S[1:0]
3	GENERAL DESCRIPTION	7.15	Addressing
4	ORDERING INFORMATION	7.15.1	Input addressing
5	BLOCK DIAGRAM	7.15.1.1	Vertical addressing non-mirrored
5.1	Block diagram functions	7.15.1.2	Vertical addressing mirrored
5.1.1	Oscillator	7.15.1.3	Horizontal addressing non-mirrored
5.1.2	Power-on reset	7.15.1.4	Horizontal addressing mirrored
5.1.3	I ² C-bus controller	7.15.1.5	Use of MX and MY bits
5.1.4	Input filters	7.15.2	Output addressing
5.1.5	Display data RAM	7.15.2.1	Mirror Y
5.1.6	Timing generator	7.15.2.2	Bottom Row Swap
5.1.7	Address counter	7.15.2.3	Top Row Swap
5.1.8	Display address counter	7.15.2.4	Output row order
6	PINNING	7.15.2.5	Interconnect possibilities using TRS and BRS
6.1	Pin functions	7.16	Instruction set
6.1.1	R0 to R64	7.16.1	RAM read/write command page
6.1.2	C0 to C132	7.16.2	Function and RAM command page
6.1.3	V _{SS1} and V _{SS2}	7.16.2.1	Command page
6.1.4	V _{DD1} to V _{DD3}	7.16.2.2	Function set
6.1.5	V _{LCDOUT}	7.16.2.3	RAM page
6.1.6	V _{LCDIN}	7.16.2.4	Set Y address of RAM
6.1.7	V _{LCDSENSE}	7.16.2.5	Set X address of RAM
6.1.8	SDA	7.16.3	Display setting command page
6.1.9	SDAOUT	7.16.4	HV-gen command page
6.1.10	SCL	7.16.5	Special feature command page
6.1.11	SA0 and SA1	7.16.6	Instruction set
6.1.12	OSC	7.17	I ² C-bus interface
6.1.13	RES	7.17.1	Characteristics of the I ² C-bus
6.1.14	T1, T2, T3, T4 and T5	7.17.2	I ² C-bus protocol
7	FUNCTIONAL DESCRIPTION	8	LIMITING VALUES
7.1	Reset	9	HANDLING
7.2	Power-down	10	DC CHARACTERISTICS
7.3	LCD supply voltage selector	11	AC CHARACTERISTICS
7.4	Oscillator	12	RESET TIMING
7.5	Timing	13	APPLICATION INFORMATION
7.6	Column driver outputs	13.1	Application for chip-on-glass
7.7	Row driver outputs	14	BONDING PAD LOCATIONS
7.8	Drive waveforms	15	DEVICE PROTECTION
7.9	Set multiplex rate	16	TRAY INFORMATION
7.10	Bias system	17	DATA SHEET STATUS
7.10.1	Set bias system	18	DEFINITIONS
7.11	Temperature measurement	19	DISCLAIMERS
7.11.1	Temperature read back	20	PURCHASE OF PHILIPS I ² C COMPONENTS
7.12	Temperature compensation	21	BARE DIE DISCLAIMER
7.12.1	Temperature coefficients		
7.13	V _{OP}		
7.13.1	Set V _{OP} value		

65 × 133 pixel matrix driver

PCF8535

1 FEATURES

- Single-chip LCD controller/driver
- 65 row, 133 column outputs
- Display data RAM 65 × 133 bits
- 133 icons (last row is used for icons)
- Fast mode I²C-bus interface (400 kbits/s)
- Software selectable multiplex rates:
1 : 17, 1 : 26, 1 : 34, 1 : 49 and 1 : 65
- On-chip:
 - Generation of intermediate LCD bias voltages
 - Oscillator requires no external components (external clock also possible)
 - Generation of V_{LCD}.
- CMOS compatible inputs
- Software selectable bias configuration
- Logic supply voltage range V_{DD1} to V_{SS1} from 4.5 to 5.5 V
- Supply voltage range for high voltage part V_{DD2} and V_{DD3} to V_{SS2} from 4.5 to 5.5 V
- Display supply voltage range V_{LCD} to V_{SS} from 8 to 16 V (Mux rate 1 : 65)
- Low power consumption, suitable for battery operated systems
- Internal Power-on reset and/or external reset
- Temperature read back available
- Manufactured in N-well silicon gate CMOS process.

**2 APPLICATIONS**

- Automotive information systems
- Telecommunication systems
- Point-of-sale terminals
- Instrumentation.

3 GENERAL DESCRIPTION

The PCF8535 is a low power CMOS LCD row/column driver, designed to drive dot matrix graphic displays at multiplex rates of 1 : 17, 1 : 26, 1 : 34, 1 : 49 and 1 : 65. Furthermore, it can drive up to 133 icons. All necessary functions for the display are provided in a single-chip, including on-chip generation of LCD bias voltages, resulting in a minimum of external components and low power consumption. The PCF8535 is compatible with most microcontrollers and communicates via an industry standard two-line bidirectional I²C-bus serial interface. All inputs are CMOS compatible.

4 ORDERING INFORMATION

TYPE NUMBER	PACKAGE		
	NAME	DESCRIPTION	VERSION
PCF8535U/2	–	chip with bumps in tray	–

65 × 133 pixel matrix driver

PCF8535

5 BLOCK DIAGRAM

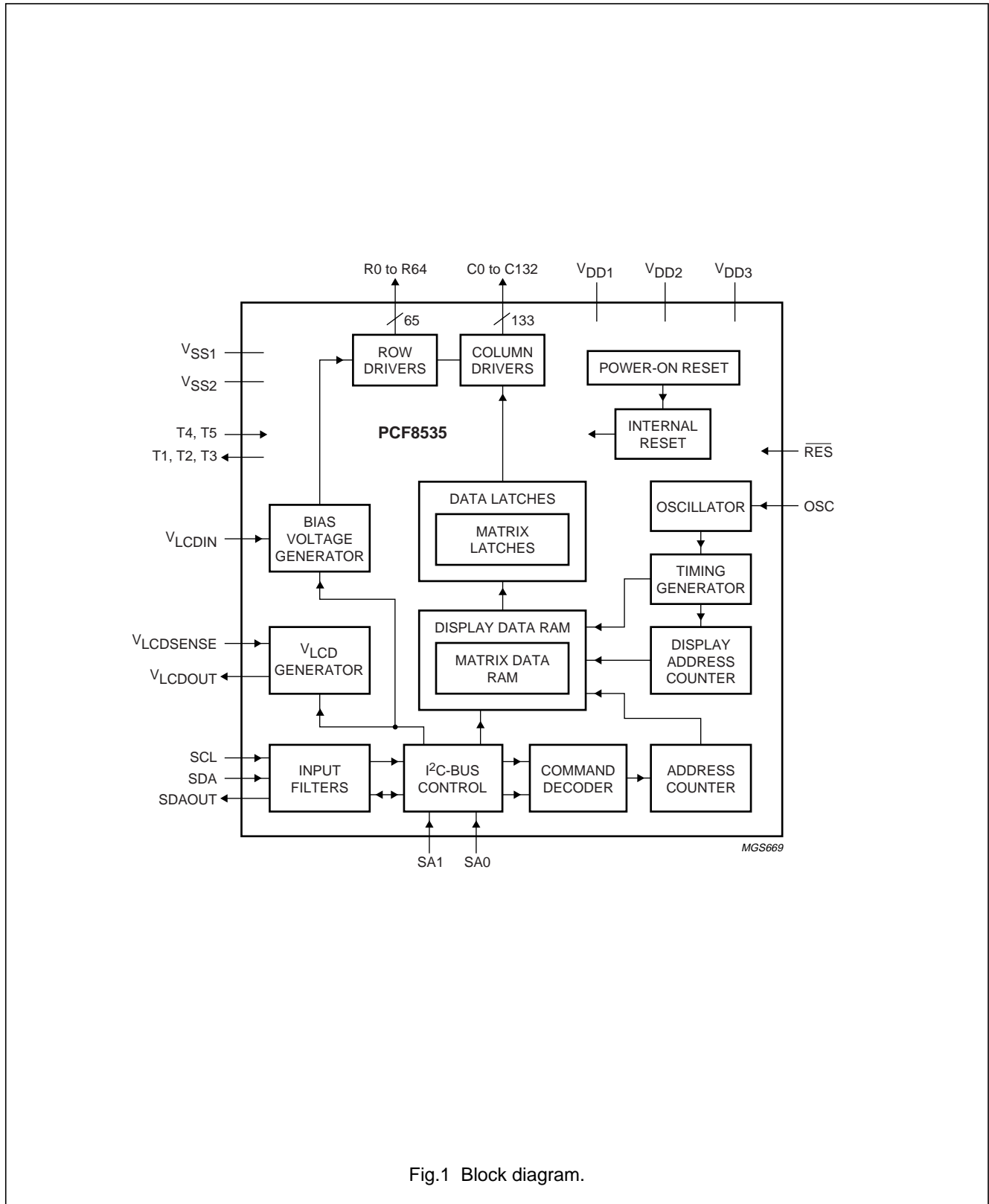

Fig.1 Block diagram.

65 × 133 pixel matrix driver**PCF8535**

5.1 Block diagram functions**5.1.1 OSCILLATOR**

The on-chip oscillator provides the display clock for the system; it requires no external components. Alternatively, an external display clock may be provided via the OSC input. The OSC input must be connected to V_{DD1} or V_{SS1} when not in use. During power-down additional current saving can be made if the external clock is disabled.

5.1.2 POWER-ON RESET

The on-chip Power-on reset initializes the chip after power-on or power failure.

5.1.3 I²C-BUS CONTROLLER

The I²C-bus controller detects the I²C-bus protocol, slave address, commands and display data bytes. It performs the conversion of the data input (serial-to-parallel). The PCF8535 acts as an I²C-bus slave and therefore cannot initiate bus communication.

5.1.4 INPUT FILTERS

Input filters are provided to enhance noise immunity in electrically adverse environments. RC low-pass filters are provided on the SDA, SCL and RES lines.

5.1.5 DISPLAY DATA RAM

The PCF8535 contains a 65 × 133 bit static RAM which stores the display data. The RAM is divided into 9 banks of 133 bytes. The last bank is used for icon data and is only one bit deep. During RAM access, data is transferred to the RAM via the I²C-bus interface. There is a direct correspondence between the X address and the column output number.

5.1.6 TIMING GENERATOR

The timing generator produces the various signals required to drive the internal circuitry. Internal chip operation is not affected by operations on the data bus.

5.1.7 ADDRESS COUNTER

The address counter sends addresses to the Display Data RAM (DDRAM) for writing.

5.1.8 DISPLAY ADDRESS COUNTER

The display is generated by continuously shifting rows of RAM data to the dot matrix LCD via the column outputs. The display status (all dots on or off, normal or inverse video) is set via the I²C-bus.

65 × 133 pixel matrix driver

PCF8535

6 PINNING

SYMBOL	PAD	DESCRIPTION
dummy	1	–
bump/align 1	2	–
R0 to R15	3 to 18	LCD row driver outputs
C0 to C132	19 to 151	LCD column driver outputs
R47 to R33	152 to 166	LCD row driver outputs
bump/align 2	167	–
dummy	168	–
R48 to R64	169 to 185	LCD row driver outputs; R64 is icon row
bump/align 3	186	–
dummy	187 to 189	–
OSC	190	oscillator
V _{LCDIN}	191 to 196	LCD supply voltage
V _{LCDOUT}	197 to 203	voltage multiplier output
V _{LCDSENSE}	204	voltage multiplier regulation input (V _{LCD})
dummy	205 and 206	–
RES	207	external reset input (active LOW)
T3	208	test output 3
T2	209	test output 2
T1	210	test output 1
V _{DD2}	211 to 218	supply voltage 2
V _{DD3}	219 to 222	supply voltage 3
V _{DD1}	223 to 228	supply voltage 1
dummy	229	–
SDA	230 and 231	I ² C-bus serial data input
SDAOUT	232	I ² C-bus serial data output
SA1	233	I ² C-bus slave address input 1
SA0	234	I ² C-bus slave address input 0
V _{SS2}	235 to 242	ground 2
V _{SS1}	243 to 250	ground 1
T5	251	test input 5
T4	252	test input 4
dummy	253	–
SCL	254 and 255	I ² C-bus serial clock input
bump/align 4	256	–
R32 to R16	257 to 273	LCD row driver outputs

65 × 133 pixel matrix driver

PCF8535

6.1 Pin functions**6.1.1 R0 TO R64**

These pads output the display row signals.

6.1.2 C0 TO C132

These pads output the display column signals.

6.1.3 V_{SS1} AND V_{SS2}

V_{SS1} and V_{SS2} must be connected together.

6.1.4 V_{DD1} TO V_{DD3}

V_{DD1} is the logic supply. V_{DD2} and V_{DD3} are for the voltage multiplier. For split power supplies V_{DD2} and V_{DD3} must be connected together. If only one supply voltage is available, all three supplies must be connected together.

6.1.5 V_{LCDOUT}

If, in the application, an external V_{LCD} is used, V_{LCDOUT} must be left open-circuit; otherwise (if the internal voltage multiplier is enabled) the chip may be damaged. V_{LCDOUT} should not be driven when V_{DD1} is below its minimum allowed value otherwise a low impedance path between V_{LCDOUT} and V_{SS1} will exist.

6.1.6 V_{LCDIN}

This is the V_{LCD} supply for when an external V_{LCD} is used. If the internal V_{LCD} generator is used, then V_{LCDOUT} and V_{LCDIN} must be connected together. V_{LCDIN} should not be driven when V_{DD1} is below its minimum allowed value, otherwise a low impedance path between V_{LCDIN} and V_{SS1} will exist.

6.1.7 V_{LCDSENSE}

This is the input to the internal voltage multiplier regulator. It must be connected to V_{LCDOUT} when the internal voltage generator is used otherwise it may be left open-circuit. V_{LCDSENSE} should not be driven when V_{DD1} is below its minimum allowed value, otherwise a low impedance path between V_{LCDSENSE} and V_{SS1} will exist.

6.1.8 SDA

I²C-bus serial data input.

6.1.9 SDAOUT

SDAOUT is the serial data acknowledge for the I²C-bus. By connecting SDAOUT to SDA externally, the SDA line becomes fully I²C-bus compatible. Having the

acknowledge output separated from the serial data line is advantageous in Chip-On-Glass (COG) applications. In COG applications where the track resistance from the SDAOUT pad to the system SDA line can be significant, a potential divider is generated by the bus pull-up resistor and the Indium Tin Oxide (ITO) track resistance. It is possible that during the acknowledge cycle the PCF8535 will not be able to create a valid LOW level. By splitting the SDA input from the SDAOUT output the device could be used in a mode that ignores the acknowledge bit. In COG applications where the acknowledge cycle is required or where read back is required, it is necessary to minimize the track resistance from the SDAOUT pad to the system SDA line to guarantee a valid LOW level.

6.1.10 SCL

I²C-bus serial clock input.

6.1.11 SA0 AND SA1

Least significant bits of the I²C-bus slave address.

Table 1 Slave address

The slave address is a concatenation of the following bits 0, 1, 1, 1, 1, SA1, SA0 and R/W.

SA1 AND SA0	MODE	SLAVE ADDRESS
0 and 0	write	78H
	read	79H
0 and 1	write	7AH
	read	7BH
1 and 0	write	7CH
	read	7DH
1 and 1	write	7EH
	read	7FH

6.1.12 OSC

If the on-chip oscillator is used this input must be connected to V_{DD1} or V_{SS1}.

6.1.13 $\overline{\text{RES}}$

When the external reset input is LOW the chip will be reset (see Section 7.1). If an external reset is not required, this pad must be tied to V_{DD1}. Timing for the $\overline{\text{RES}}$ pad is given in Chapter 12.

6.1.14 T1, T2, T3, T4 AND T5

In applications T4 and T5 must be connected to V_{SS}. T1, T2 and T3 are to be left open-circuit.

65 × 133 pixel matrix driver

PCF8535

7 FUNCTIONAL DESCRIPTION

The PCF8535 is a low power LCD driver designed to interface with microprocessors or microcontrollers and a wide variety of LCDs.

The host microprocessor or microcontroller and the PCF8535 are both connected to the I²C-bus. The SDA and SCL lines must be connected to the positive power supply

via pull-up resistors. The internal oscillator requires no external components. The appropriate intermediate biasing voltages for the multiplexed LCD waveforms are generated on-chip. The only other connections required to complete the system are to the power supplies (V_{DD}, V_{SS} and V_{LCD}) and suitable capacitors for decoupling V_{LCD} and V_{DD}.

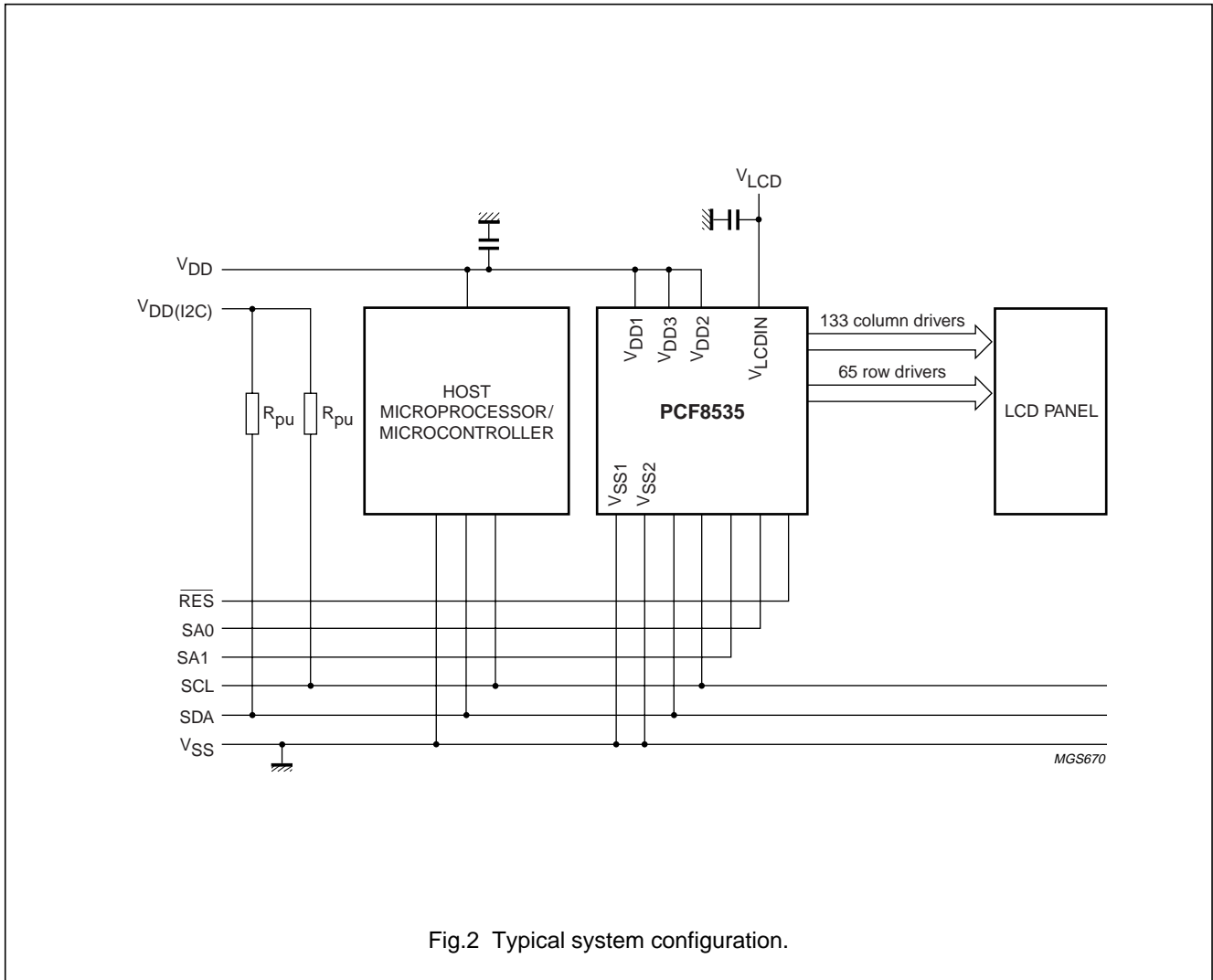

Fig.2 Typical system configuration.

65 × 133 pixel matrix driver

PCF8535

7.1 Reset

The PCF8535 has two Reset modes: internal Power-on reset or external reset. Reset initiated from either the $\overline{\text{RES}}$ pad or the internal Power-on reset block will initialize the chip to the following starting condition:

- Power-down mode (PD = 1)
- Horizontal addressing (V = 0); no mirror X or Y (MX = 0 and MY = 0)
- Display blank (D = 0 and E = 0)
- Address counter X[6:0] = 0, Y[2:0] = 0 and XM₀ = 0
- Bias system BS[2:0] = 0
- Multiplex rate M[2:0] = 0 (Mux rate 1 : 17)
- Temperature control mode TC[2:0] = 0
- HV-gen control, HVE = 0 (HV generator is switched off), PRS = 0 and S[1:0] = 00
- V_{LCDOUT} is equal to 0 V
- RAM data is unchanged (Remark: RAM data is undefined after power-up)
- All row and column outputs are set to V_{SS} (display off)
- TRS and BRS are set to zero
- Direct mode is disabled (DM = 0)
- Internal oscillator is selected, but not running (EC = 0)
- Bias current set to low current mode (IB = 0).

7.2 Power-down

During power-down all static currents are switched off (no internal oscillator, no timing and no LCD segment drive system) and all LCD outputs are internally connected to V_{SS}. The I²C-bus function remains active.

7.3 LCD supply voltage selector

The practical value for V_{OP} is determined by equating V_{off(rms)} with the defined LCD threshold voltage (V_{th}), typically when the LCD exhibits approximately 10% contrast.

7.4 Oscillator

The internal logic operation and the multi-level drive signals of the PCF8535 are clocked by the built-in RC oscillator. No external components are required.

7.5 Timing

The timing of the PCF8535 organizes the internal data flow of the device. The timing also generates the LCD frame frequency which is derived from the clock frequency generated by the internal clock generator.

7.6 Column driver outputs

The LCD drive section includes 133 column outputs (C0 to C132) which should be connected directly to the LCD. The column output signals are generated in accordance with the multiplexed row signals and with the data in the display latch. When less than 133 columns are required the unused column outputs should be left open-circuit.

7.7 Row driver outputs

The LCD drive section includes 65 row outputs (R0 to R64) which should be connected directly to the LCD. The row output signals are generated in accordance with the selected LCD drive mode. If lower multiplex rates or less than 65 rows are required, the unused outputs should be left open-circuit.

65 × 133 pixel matrix driver

PCF8535

7.8 Drive waveforms

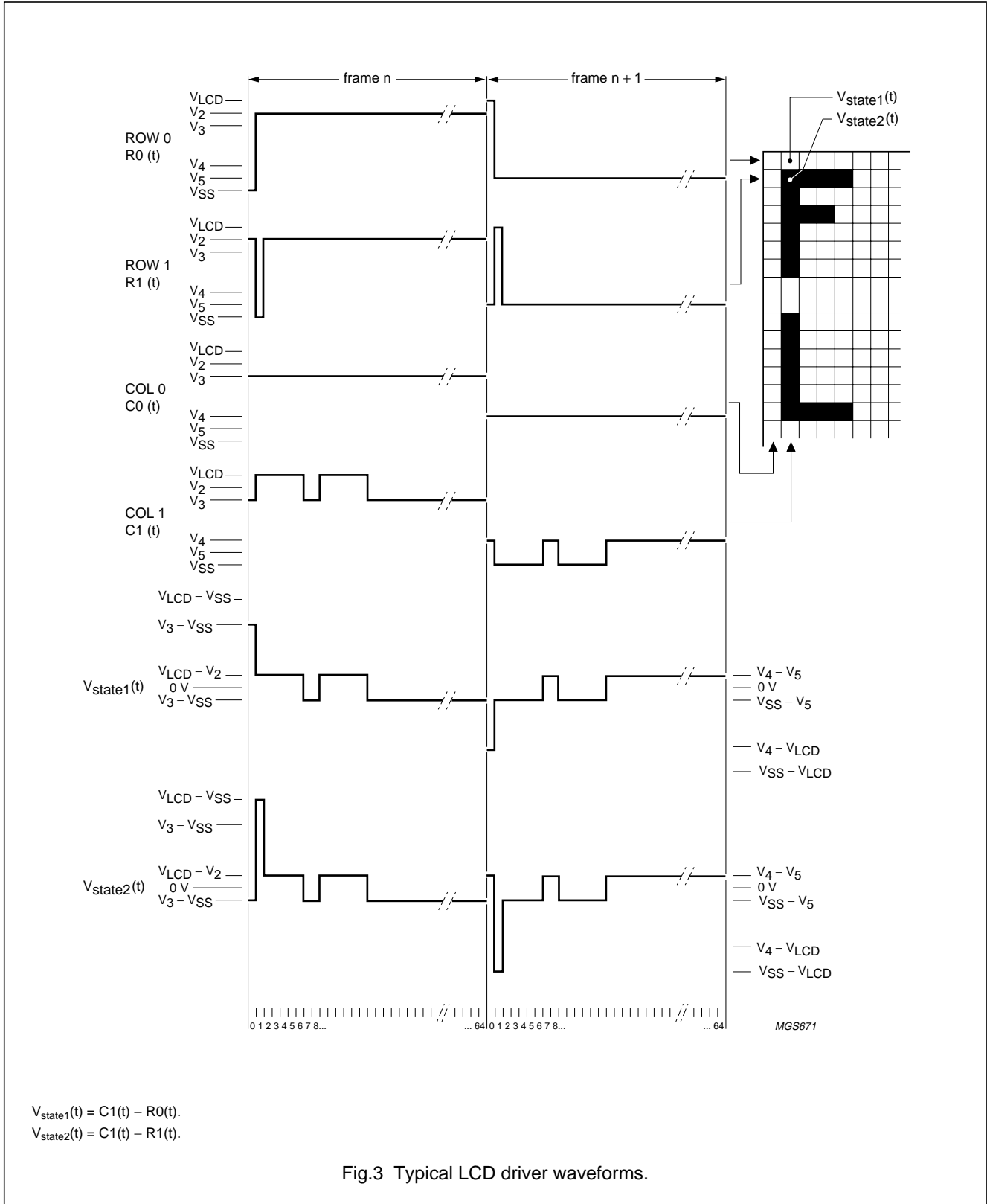

65 × 133 pixel matrix driver

PCF8535

7.9 Set multiplex rate

The PCF8535 can be used to drive displays of varying sizes. The selected multiplex rate controls which rows are used. In all cases, the last row is always driven and is intended for icons. If Top Row Swap (TRS) is at logic 1, then the icon row will be output on pad R48. M[2:0] selects the multiplex rate (see Table 2).

Table 2 Multiplex rates

M2	M1	M0	MULTIPLEX RATE	ACTIVE ROWS
0	0	0	1 : 17	R0 to R15 and R64
0	0	1	1 : 26	R0 to R24 and R64
0	1	0	1 : 34	R0 to R32 and R64
0	1	1	1 : 49	R0 to R47 and R64
1	0	0	1 : 65	R0 to R64
1	0	1	do not use	–
:	:	:	:	:
1	1	1	do not use	–

7.10 Bias system

7.10.1 SET BIAS SYSTEM

The bias voltage levels are set in the ratio of R – R – nR – R – R. Different multiplex rates require different factors n. This is programmed by BS[2:0]. For optimum bias values, n can be calculated from:

$$n = \sqrt{\text{Mux rate} - 3}$$

Changing the bias system from the optimum values will have a consequence on the contrast and viewing angle. One reason to come away from the optimum would be to reduce the required V_{OP}. A compromise between contrast and V_{OP} must be found for any particular application.

Table 3 Programming the required bias system

BS2	BS1	BS0	n	BIAS MODE	TYPICAL MUX RATES
0	0	0	7	1/11	1 : 100
0	0	1	6	1/10	1 : 80
0	1	0	5	1/9	1 : 65
0	1	1	4	1/8	1 : 49
1	0	0	3	1/7	1 : 34
1	0	1	2	1/6	1 : 26
1	1	0	1	1/5	1 : 17
1	1	1	0	1/4	1 : 9

Table 4 Example of LCD bias voltage for 1/7 bias mode (n = 3)

SYMBOL	BIAS VOLTAGE
V1	V _{LCD}
V2	⁶ / ₇ × V _{LCD}
V3	⁵ / ₇ × V _{LCD}
V4	² / ₇ × V _{LCD}
V5	¹ / ₇ × V _{LCD}
V6	V _{SS}

7.11 Temperature measurement

7.11.1 TEMPERATURE READ BACK

The PCF8535 has an in-built temperature sensor. For power saving, the sensor should only be enabled when a measurement is required. It will not operate in the Power-down mode. The temperature read back requires a clock to operate. Normally the internal clock is used but, if the device is operating from an external clock, then this clock must be present for the measurement to work.

V_{DD2} and V_{DD3} must also be applied. A measurement is initialized by setting the SM bit. Once started the SM bit will be automatically cleared. An internal oscillator will be initialized and allowed to warm-up for approximately 2 frame periods. After this the measurement starts and lasts for a maximum of 2 frame periods.

Temperature data is returned via a status register. During the measurement the register will contain zero. Once the measurement is completed the register will be updated with the current temperature (non zero value). Because the I²C-bus interface is asynchronous to the temperature measurement, read back prior to the end of the measurement is not guaranteed. If this mode is required the register should be read twice to validate the data.

The ideal temperature read-out can be calculated as follows:

$$TR_{ideal} = 128 + (T - 27) \times \frac{1}{c} \tag{1}$$

where T is the on-chip temperature in °C and c is the conversion constant: c = 1.17 °C/lsb.

It should be noted that the temperature read-out is only valid when TC0 is selected. If another TC is used, the read-out function will generate a non-linear result.

To improve the accuracy of the temperature measurement a calibration is recommended during the assembly of the final product.

65 × 133 pixel matrix driver

PCF8535

For calibrating the temperature read-out a measurement must be taken at a defined temperature. The offset between the ideal read-out and the actual result has to be stored into a non-volatile register (e.g. EEPROM):

$$\text{Offset} = TR_{\text{ideal}} - TR_{\text{meas}} \tag{2}$$

where TR_{meas} is the actual temperature read-out of the PCF8535.

The calibrated temperature read-out can be calculated for each measurement as follows:

$$TR_{\text{cal}} = TR_{\text{meas}} + \text{Offset} \tag{3}$$

The accuracy after the calibration is ±6.7% (plus ±1 lsb) of the difference between the current temperature and the calibration temperature. For this reason a calibration at or near the most sensitive temperature for the display is recommended. E.g. for a calibration at 25 °C with the current temperature at -20 °C, the absolute error may be calculated as:

$$\begin{aligned} \text{Absolute error} &= 0.067 \times [25 - (-20)] \\ &= \pm 3 \text{ }^\circ\text{C} + \pm 1 \text{ lsb} = \pm 4.17 \text{ }^\circ\text{C}. \end{aligned}$$

7.12 Temperature compensation

7.12.1 TEMPERATURE COEFFICIENTS

Due to the temperature dependency of the liquid crystals viscosity the LCD controlling voltage, Voltage must be increased at lower temperatures to maintain optimum contrast. Fig.4 shows V_{LCD} as a function of temperature for a typical high multiplex rate liquid.

In the PCF8535 the temperature coefficient of V_{LCD} can be selected from 8 values by setting bits TC[2:0] (see Table 5).

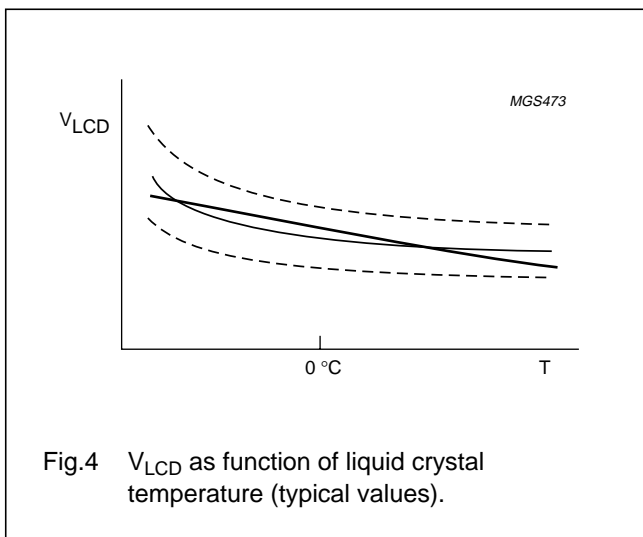

Table 5 Selectable temperature coefficients

TC2	TC1	TC0	TC VALUE	UNIT
0	0	0	0	1/°C
0	0	1	-0.44 × 10 ⁻³	1/°C
0	1	0	-1.10 × 10 ⁻³	1/°C
0	1	1	-1.45 × 10 ⁻³	1/°C
1	0	0	-1.91 × 10 ⁻³	1/°C
1	0	1	-2.15 × 10 ⁻³	1/°C
1	1	0	-2.32 × 10 ⁻³	1/°C
1	1	1	-2.74 × 10 ⁻³	1/°C

7.13 V_{OP}

7.13.1 SET V_{OP} VALUE

The voltage at the reference temperature (T_{cut}) can be calculated as:

$$V_{\text{LCD}(T_{\text{cut}})} = a + b \times V_{\text{OP}} \tag{4}$$

The operating voltage, V_{OP} , can be set by software. The generated voltage is dependent on the temperature, programmed Temperature Coefficient (TC) and the programmed voltage at the reference temperature (T_{cut}):

$$V_{\text{LCD}} = (a + b \times V_{\text{OP}}) \times \{1 + [(T - T_{\text{cut}}) \times \text{TC}]\} \tag{5}$$

The values for T_{cut} , a and b are given in Table 6. The maximum voltage that can be generated is dependent on the voltage V_{DD2} and the display load current. Two overlapping V_{OP} ranges are selectable via the command page “HV-gen control” (see Fig.5).

The LOW range offers programming from 4.5 to 10.215 V, with the HIGH range from 10.215 to 15.93 V at T_{cut} . Care must be taken, when using temperature coefficients, that the programmed voltage does not exceed the maximum allowed V_{LCD} , see Chapter 10.

For a particular liquid, the optimum V_{LCD} can be calculated for a given multiplex rate. For a Mux rate of 1 : 65, the optimum operating voltage of the liquid can be calculated as:

$$V_{\text{LCD}} = \frac{1 + \sqrt{65}}{\sqrt{2 \times \left(1 - \frac{1}{\sqrt{65}}\right)}} \times V_{\text{th}} = 6.85 \times V_{\text{th}} \tag{6}$$

where V_{th} is the threshold voltage of the liquid crystal material used.

65 × 133 pixel matrix driver

PCF8535

Table 6 Values for parameters of V_{OP} programming

SYMBOL	BITS	VALUE	UNIT
a	PRS = 0	4.5	V
	PRS = 1	10.215	V
b		0.045	V
T_{cut}		27	°C

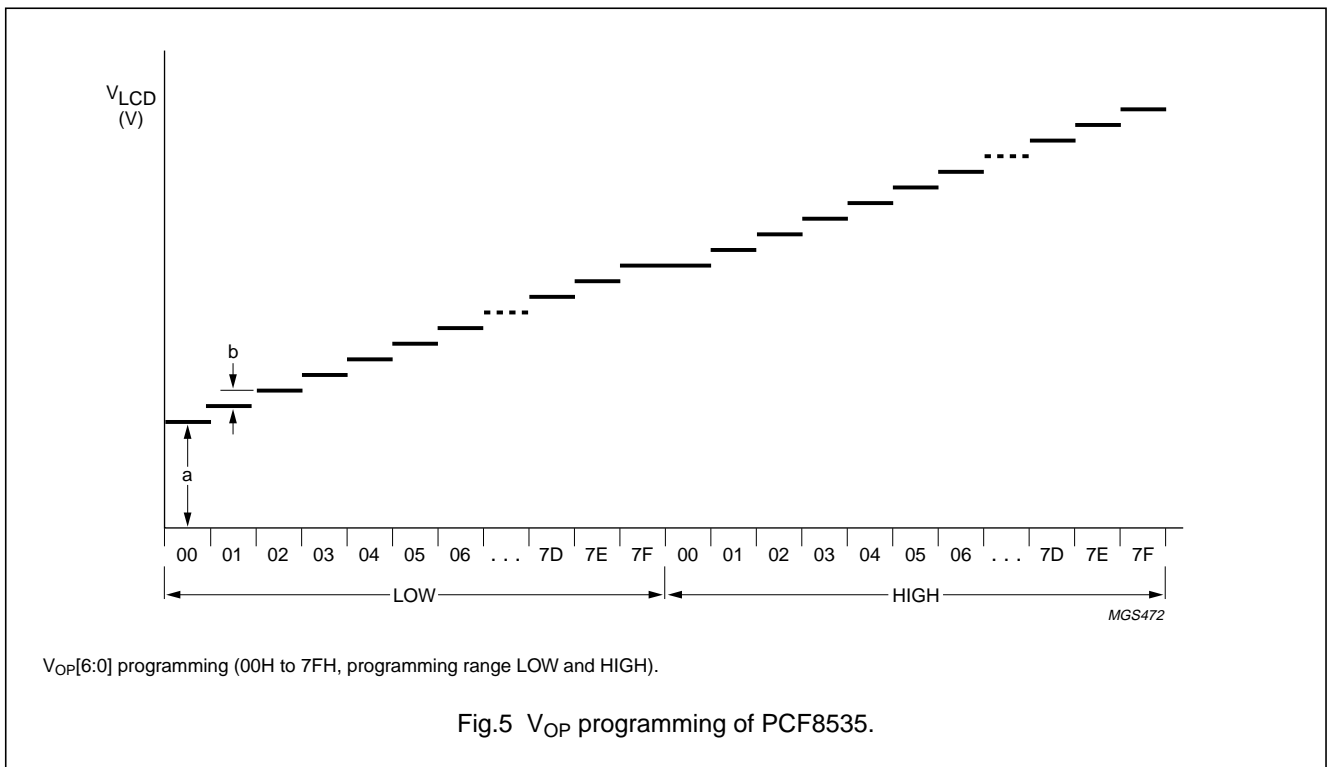

7.14 Voltage multiplier control

7.14.1 S[1:0]

The PCF8535 incorporates a software configurable voltage multiplier. After reset (\overline{RES}) the voltage multiplier is set to $2 \times V_{DD2}$. Other voltage multiplier factors are set via the HV-gen command page. Before switching on the charge pump, the charge pump has to be pre-charged using the following sequence.

A starting state of HVE = 0, DOF = 0, PD = 1 and DM = 0 is assumed. A small delay between the steps is indicated. The recommended wait period is 20 μ s per 100 nF of the capacitance on V_{LCD} .

1. Set DM = 1 and PD = 0
2. Delay
3. Set the multiplication factor to 2 by setting S[1:0] = 00

4. Set the required V_{OP} and PRS.
5. Set HVE = 1 to switch-on the charge pump with a multiplication factor of 2
6. Delay
7. Increase the number of stages, one at a time, with a delay between each until the required level is achieved.

Table 7 HV generator multiplication factor

S1	S0	MULTIPLICATION FACTOR
0	0	$2 \times V_{DD2}$
0	1	$3 \times V_{DD2}$
1	0	$4 \times V_{DD2}$
1	1	$5 \times V_{DD2}$

65 × 133 pixel matrix driver

PCF8535

7.15 Addressing

Addressing of the RAM can be split into two parts: input addressing and output addressing. Input addressing is concerned with writing data into the RAM. Output addressing is almost entirely automatic and taken care of by the device, however, it is possible to affect the output mode.

The display RAM has a matrix of 65 × 133 bits. The columns are addressed by a combination of the X address pointer and the X-RAM page pointer, whilst the rows are addressed in groups of 8 by the Y address pointer. The X address pointer has a range of 0 to 127 (7FH). Its range can be extended by the X-RAM page pointer XM₀. The Y address pointer has a range of 0 to 8 (08H). The PCF8535 is limited to 133 columns by 65 rows, addressing the RAM outside of this area is not allowed.

7.15.1 INPUT ADDRESSING

Data is downloaded byte wise into the RAM matrix of the PCF8535 as indicated in Figs 6 to 10.

Table 8 Effect of X-RAM page pointer

X ADDRESS POINTER	X-RAM PAGE POINTER XM ₀	ADDRESSED COLUMN MX = 0	ADDRESSED COLUMN MX = 1
0	0	C0	C132
1	0	C1	C131
2	0	C2	C130
:	:	:	:
125	0	C125	C7
126	0	C126	C6
127	0	C127	C5
0	1	C128	C4
1	1	C129	C3
:	:	:	:
4	1	C132	C0

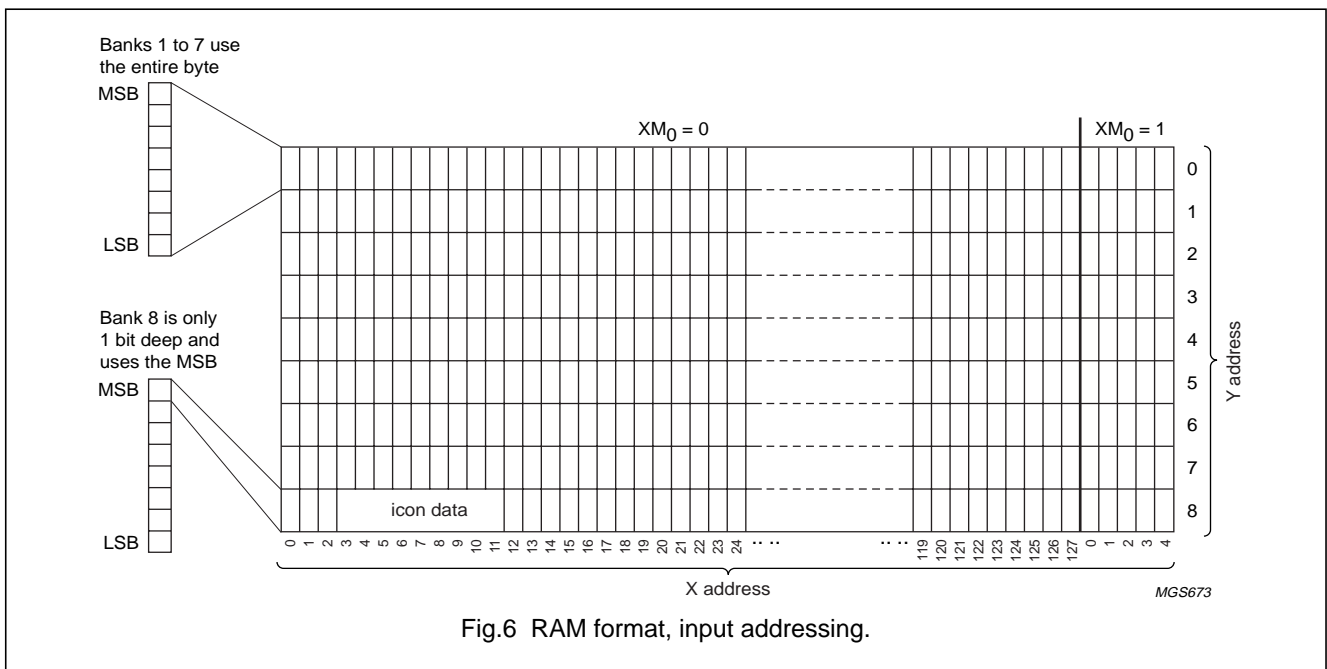

Fig.6 RAM format, input addressing.

65 × 133 pixel matrix driver

PCF8535

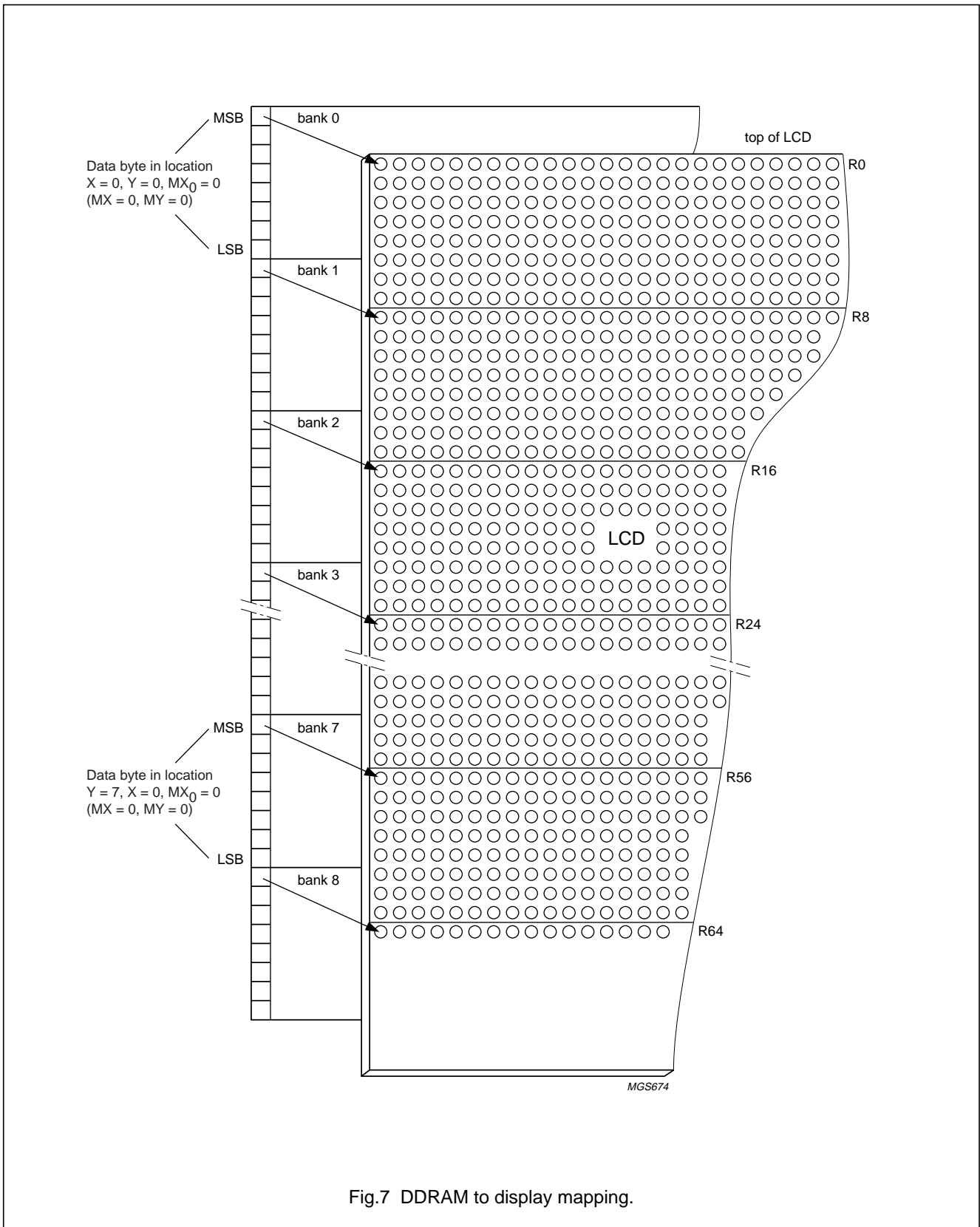

Fig.7 DDRAM to display mapping.

65 × 133 pixel matrix driver

PCF8535

Two automated addressing modes are available: vertical addressing ($V = 1$) and horizontal addressing ($V = 0$). These modes change the way in which the auto-incrementing of the address pointers is handled and are independent of multiplex rate. The auto-incrementing works in a way so as to aid filling of the entire RAM. It is not a prerequisite of operation that the entire RAM is filled: in lower multiplex rates not all of the RAM will be needed. For these multiplex rates, use of horizontal addressing mode ($V = 0$) is recommended.

Addressing the icon row is a special case as these RAM locations are not automatically accessed. These locations must be explicitly addressed by setting the Y address pointer to 8.

The Y address pointer does not auto-increment when the X address over or underflows, it stays set to 8. Writing icon data is independent of the vertical and horizontal addressing mode, but is effected by the mirror X bit as described in Sections 7.15.1.2 and 7.15.1.3.

The addressing modes may be further modified by the mirror X bit MX. This bit causes the data to be written into the RAM from right to left instead of the normal left to right. This effectively flips the display about the Y axis. The MX bit affects the mode of writing into the RAM; changing the MX bit after RAM data is written will not flip the display.

7.15.1.1 Vertical addressing non-mirrored

In the vertical addressing mode data is written top to bottom and left to right. Here, the Y counter will auto-increment from 0 to 7 and then wrap around to 0 (see Fig.8). On each wrap-over, the X counter will increment to address the next column. When the X counter wraps over from 127 to 0, the XM_0 bit will be set. The last address accessible is $Y = 7, X = 4$ and $XM_0 = 1$; after this access the counter will wrap around to $Y = 0, X = 0$ and $XM_0 = 0$.

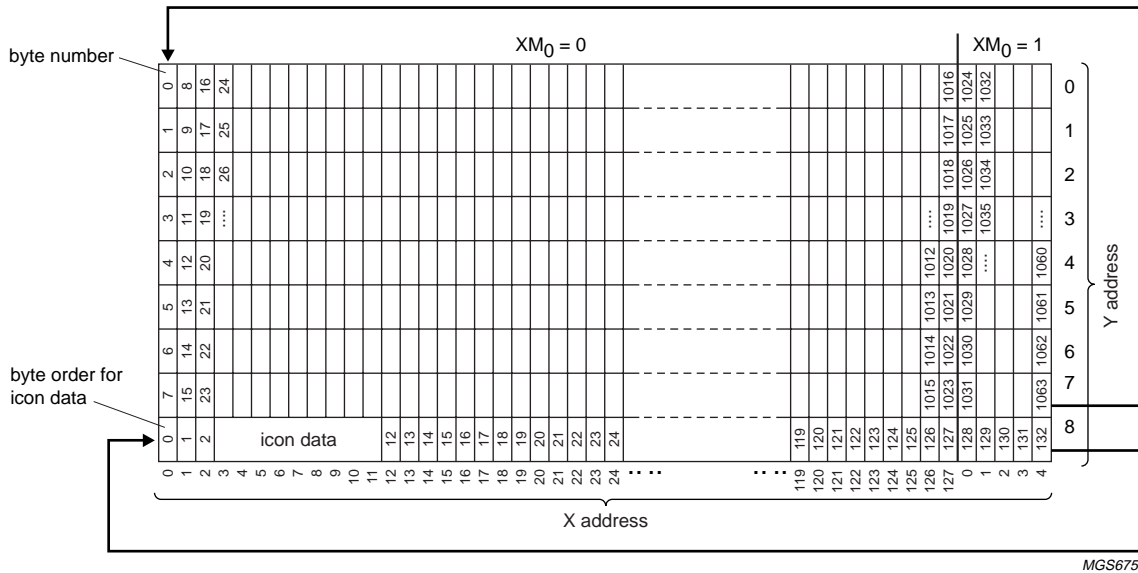

Fig.8 Sequence of writing data bytes into the RAM with normal vertical addressing ($V = 1$ and $MX = 0$).

65 × 133 pixel matrix driver

PCF8535

7.15.1.4 Horizontal addressing mirrored

It is also possible to write data from right to left, instead of from the normal left to right, still going top to bottom. In the mirrored horizontal addressing mode the X counter will auto-decrement from 4 to 0, clear the XM₀, then count

127 to 0 before wrapping around to 4 and setting the XM₀ bit (see Fig.11). On each wrap-over, the Y counter will increment. The last address accessible is Y = 7, X = 4 and XM₀ = 0; after this access the counter will wrap around to Y = 0, X = 0 and XM₀ = 0.

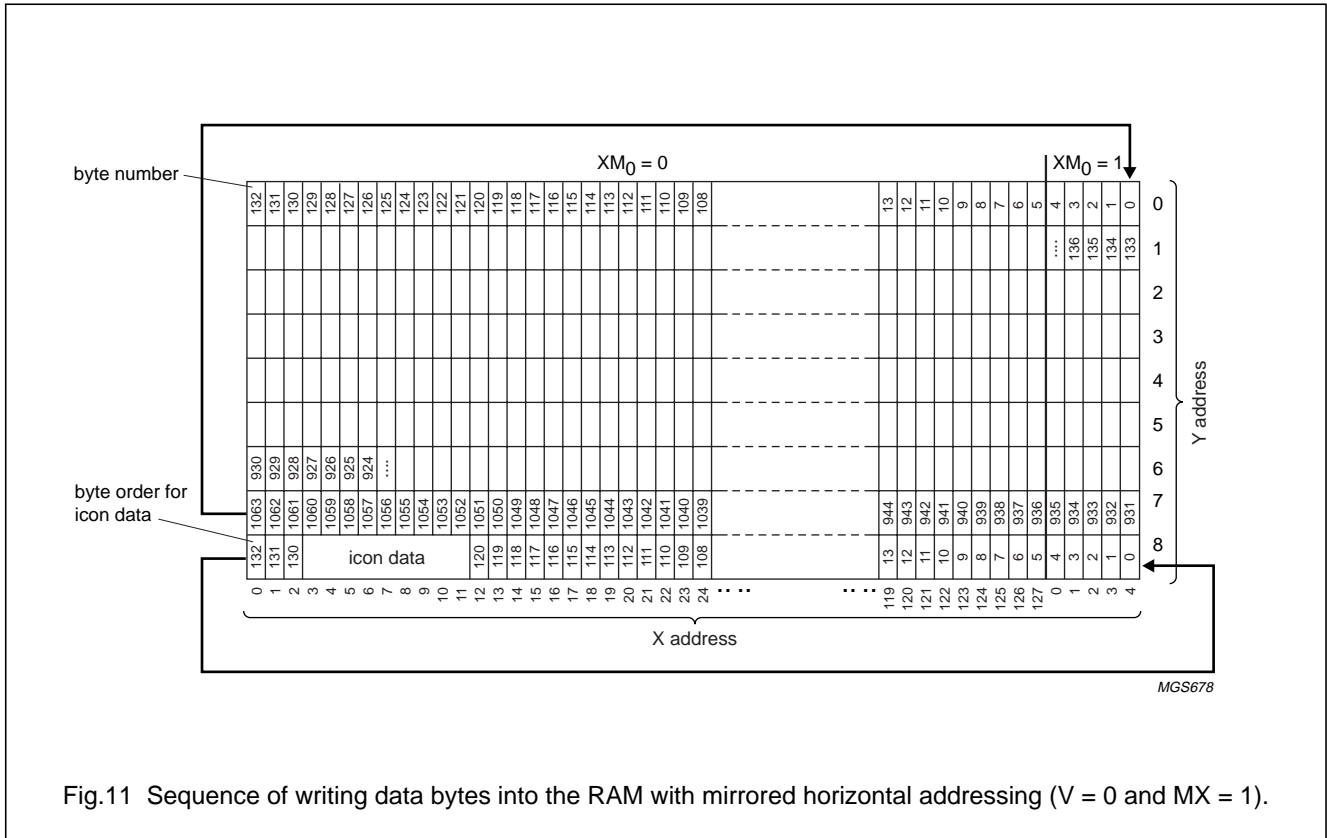

Fig.11 Sequence of writing data bytes into the RAM with mirrored horizontal addressing (V = 0 and MX = 1).

65 × 133 pixel matrix driver

PCF8535

7.15.1.5 Use of MX and MY bits

The MX bit is used to flip the display left to right; as shown in Fig.12. This utility allows the display to be viewed from behind instead of on top, allowing for flexibility in the assembly of equipment and saving complicated data manipulation within the controller.

The MY bits flips the display top to bottom. A combination of MY and MX allows the display to be rotated 180 deg; as shown in Fig.13. This utility is useful for viewing the display from the opposite edge.

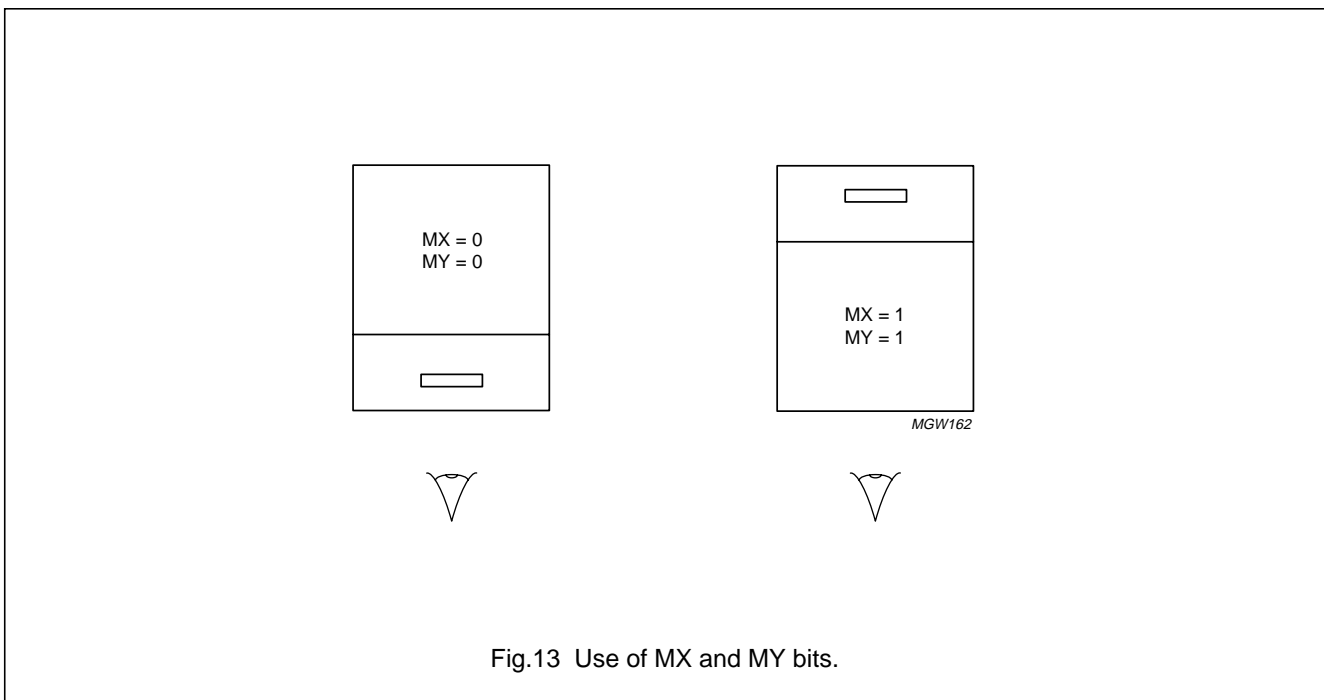
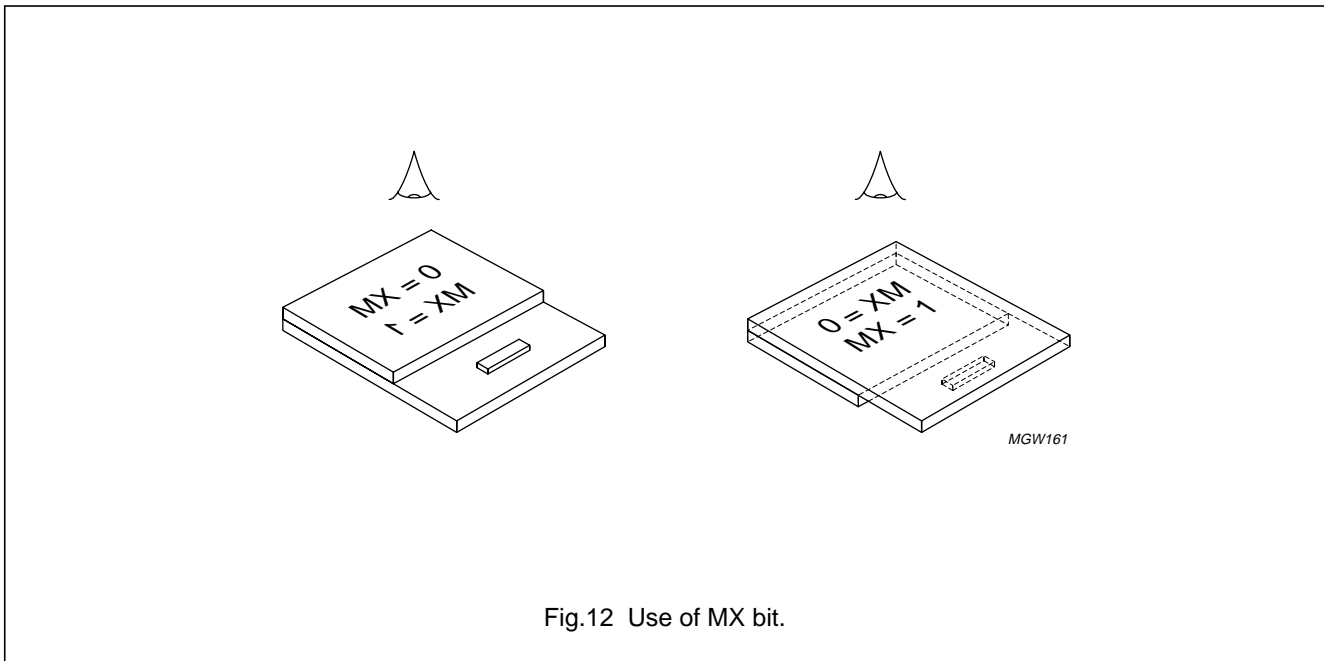

65 × 133 pixel matrix driver

PCF8535

7.15.2 OUTPUT ADDRESSING

The output addressing of the RAM is done automatically in accordance with the currently selected multiplex rate. Normally the user would not need to make any alterations to the addressing. There are, however, circumstances pertaining to various connectivity of the device on a glass that would benefit from some built-in functionality. Three modes exist that enable the user to modify the output addressing:

1. Mirror the Y axis (bit MY). This mode effectively flips the display around the X axis, resulting in an upside down display. The effect is observable immediately the bit is modified. This is useful if the device is to be mounted above the display area instead of below.

2. Bottom Row Swap (BRS). This mode swaps the order of the rows on the bottom⁽¹⁾ edge of the chip. This is useful to aid routing to the display when it is not possible to pass tracks under the device; a typical example would be in tape carrier package. This mode is often used in conjunction with TRS.
3. Top Row Swap (TRS). As with BRS, but swaps the order of rows on the top⁽¹⁾ edge of the chip.

7.15.2.1 Mirror Y

As described above, the Y axis is mirrored in the X axis.

(1) The top edge is defined as the edge containing the user interface pads. The bottom edge is the opposing edge.

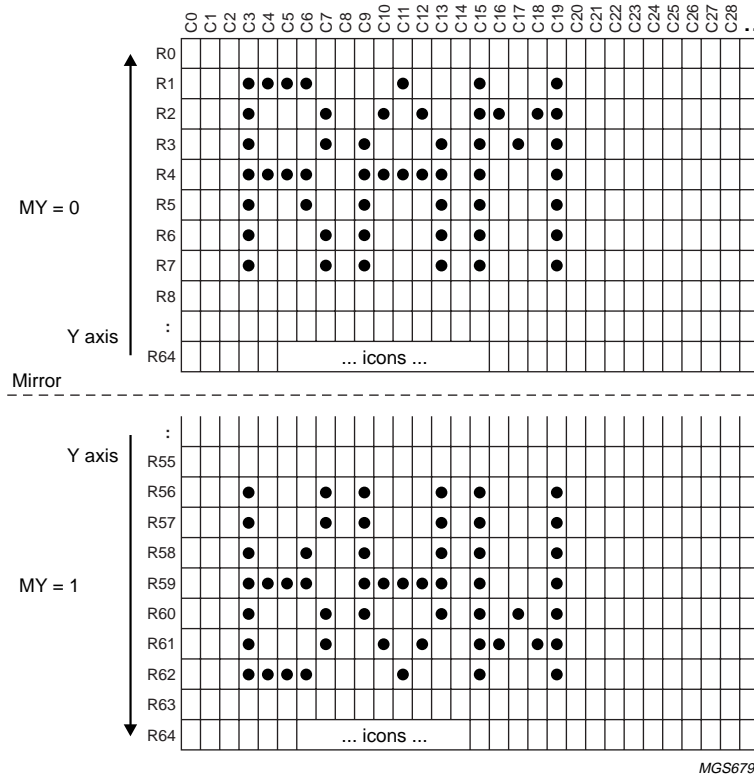

Fig.14 Mirror Y behaviour (Mux rate 1 : 65).

65 × 133 pixel matrix driver

PCF8535

7.15.2.2 Bottom Row Swap

Here the order of the row pads is modified. Each block of rows is swapped around its local Y axis.

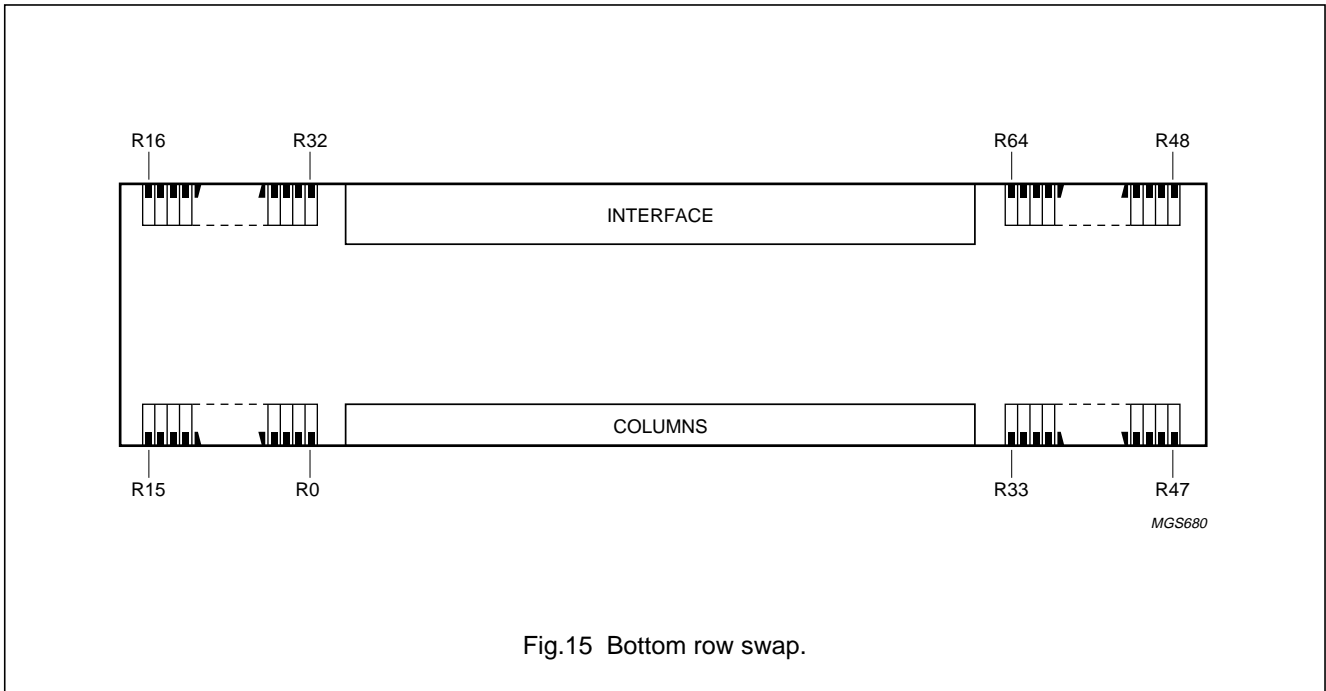

7.15.2.3 Top Row Swap

Here the order of the row pads is modified. Each block of rows is swapped around its local Y axis.

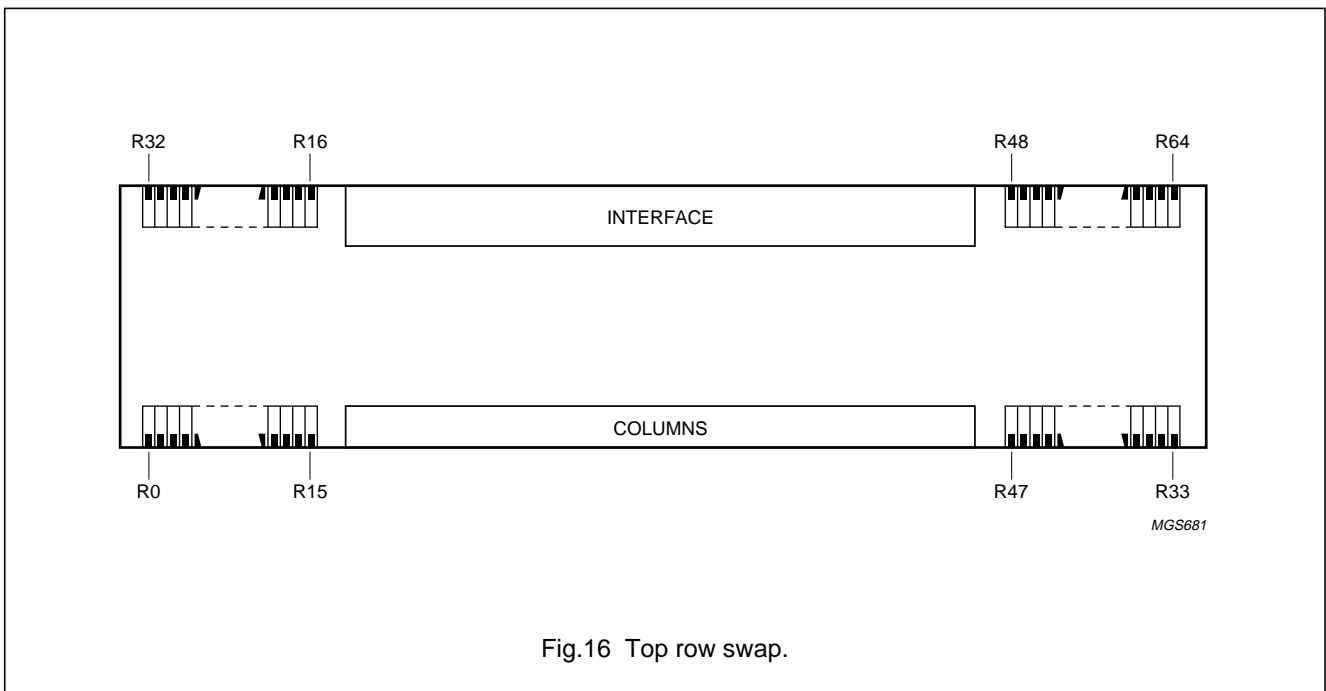

65 × 133 pixel matrix driver

PCF8535

7.15.2.4 Output row order

The order in which the rows are activated is a function of bits MY, TRS, BRS and the selected multiplex rate. Tables 9 to 12 give the order in which the rows are activated. In all cases, the RAM is accessed in a linear

fashion, starting at zero, counting to the last row and then jumping to the end for the icon data. When MY = 1, the RAM is still accessed in a linear fashion but starting from the last row, counting down to zero and then jumping to the icon data.

Table 9 Row order for BRS = 0 and TRS = 0

MULTIPLEX RATE	ROW ACTIVATION	RAM ACCESS (MY = 0)	RAM ACCESS (MY = 1)
1 : 17	R0 to R15 and R64	0 to 15 and 64	15 to 0 and 64
1 : 26	R0 to R24 and R64	0 to 24 and 64	24 to 0 and 64
1 : 34	R0 to R32 and R64	0 to 32 and 64	32 to 0 and 64
1 : 49	R0 to R47 and R64	0 to 47 and 64	47 to 0 and 64
1 : 65	R0 to R64	0 and 64	63 to 0 and 64

Table 10 Row order for BRS = 1 and TRS = 0

MULTIPLEX RATE	ROW ACTIVATION	RAM ACCESS (MY = 0)	RAM ACCESS (MY = 1)
1 : 17	R15 to R0 and R64	0 to 15 and 64	15 to 0 and 64
1 : 26	R15 to R0, R16 to R24 and R64	0 to 24 and 64	24 to 0 and 64
1 : 34	R0 to R32 and R64	0 to 32 and 64	32 to 0 and 64
1 : 49	R15 to R0, R16 to R32, R47 to R33 and R64	0 to 47 and 64	47 to 0 and 64
1 : 65	R15 to R0, R16 to R32, R47 to R33 and R48 to R64	0 and 64	63 to 0 and 64

Table 11 Row order for BRS = 0 and TRS = 1

MULTIPLEX RATE	ROW ACTIVATION	RAM ACCESS (MY = 0)	RAM ACCESS (MY = 1)
1 : 17	R0 to R15 and R48	0 to 15 and 64	15 to 0 and 64
1 : 26	R0 to R15, R32 to R24 and R48	0 to 24 and 64	24 to 0 and 64
1 : 34	R0 to R15, R32 to R16 and R48	0 to 32 and 64	32 to 0 and 64
1 : 49	R0 to R15, R32 to R16, R33 to R47 and R48	0 to 47 and 64	47 to 0 and 64
1 : 65	R0 to R15, R32 to R16, R33 to R47 and R64 to R48	0 and 64	63 to 0 and 64

Table 12 Row order for BRS = 1 and TRS = 1

MULTIPLEX RATE	ROW ACTIVATION	RAM ACCESS (MY = 0)	RAM ACCESS (MY = 1)
1 : 17	R15 to R0 and R48	0 to 15 and 64	15 to 0 and 64
1 : 26	R15 to R0, R32 to R24 and R48	0 to 24 and 64	24 to 0 and 64
1 : 34	R15 to R0, R32 to R16 and R48	0 to 32 and 64	32 to 0 and 64
1 : 49	R15 to R0, R32 to R16, R47 to R33 and R48	0 to 47 and 64	47 to 0 and 64
1 : 65	R15 to R0, R32 to R16, R47 to R33 and R64 to R48	0 and 64	63 to 0 and 64

65 × 133 pixel matrix driver

PCF8535

7.15.2.5 Interconnect possibilities using TRS and BRS

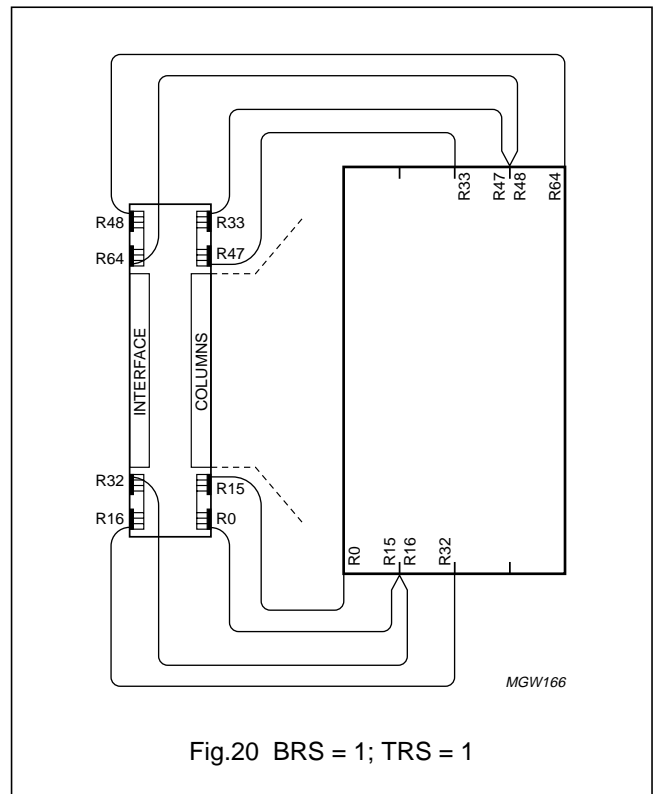
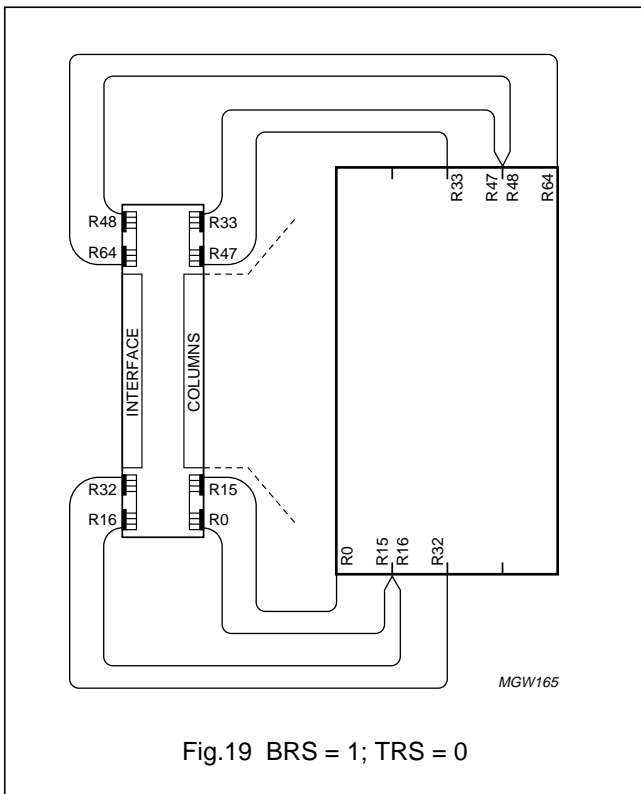
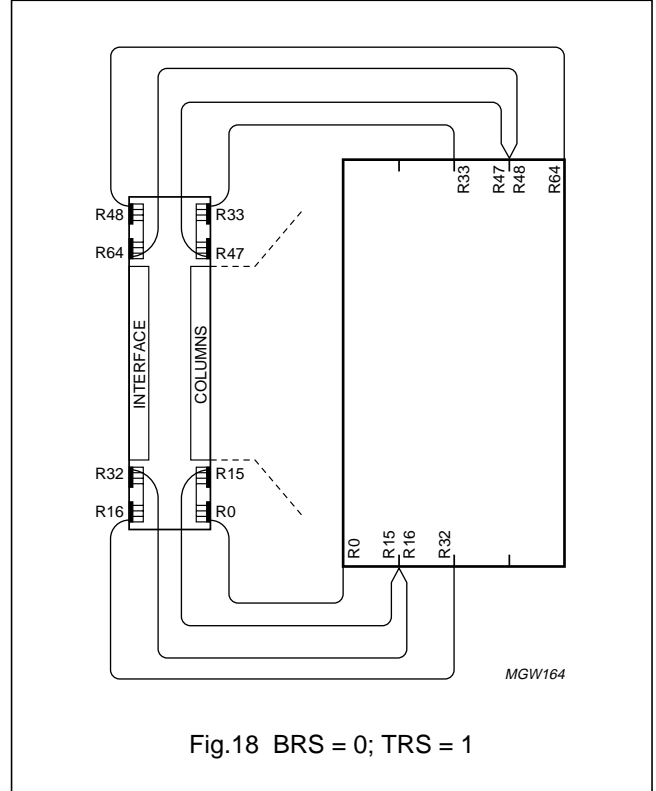
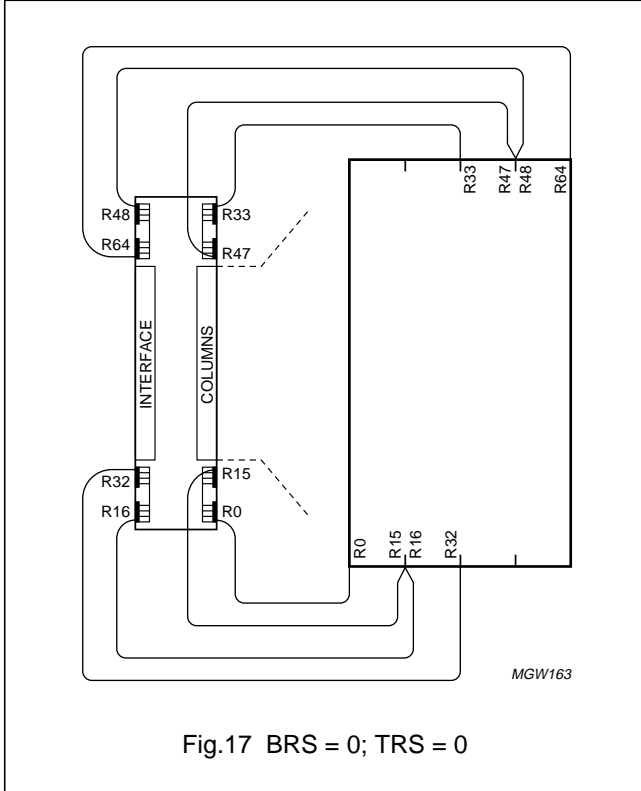

65 × 133 pixel matrix driver

PCF8535

7.16 Instruction set

Data accesses to the PCF8535 can be broken down into two areas, those that define the operating mode of the device and those that fill the display RAM; the distinction being the D/\bar{C} bit. When bit $D/\bar{C} = 0$, the device will respond to instructions as defined in Table 16. When bit $D/\bar{C} = 1$, the device will store data into the RAM. Data may be written to the device that is independent to the presence of the display clock.

There are 4 instruction types:

1. Define PCF8535 functions such as display configuration, etc.
2. Set internal RAM addresses
3. Perform data transfer with internal RAM
4. Others.

In normal use, type 3 instructions are the most frequently used. To lessen the MPU program load, automatic incrementing by one of the internal RAM address pointers after each data write is implemented.

The instruction set is broken down into several pages, each command page being individually addressed via the $H[2:0]$ bits.

7.16.1 RAM READ/WRITE COMMAND PAGE

This page is special in that it is accessible independently of the H bits. This page is mainly used as a stepping stone to other pages. Sending the 'Default $H[2:0]$ ' command will cause an immediate step to the 'Function and RAM command page' which will allow the $H[2:0]$ bits to be set.

7.16.2 FUNCTION AND RAM COMMAND PAGE**7.16.2.1 Command page**

Setting $H[2:0]$ will move the user immediately to the required command page. Pages not listed should not be accessed as the behaviour is not defined.

7.16.2.2 Function set**PD**

When $PD = 1$, the LCD driver is in Power-down mode:

- All LCD outputs at V_{SS}
- Oscillator off
- V_{LCDIN} may be disconnected
- I²C-bus interface accesses are possible
- RAM contents are not cleared; RAM data can be written
- Register settings remain unchanged.

V

When $V = 0$, horizontal addressing is selected. When $V = 1$, vertical addressing is selected. The behaviour is described in Section 7.15.

7.16.2.3 RAM page

The XM_0 bit extends the RAM into a second page. The bit may be considered to be the Most Significant Bit (MSB) of an 8-bit X address. The behaviour is described in Section 7.15.

7.16.2.4 Set Y address of RAM

The Y address is used as a pointer to the RAM for RAM writing. The range is 0 to 8. Each bank corresponds to a set of 8 rows; the only exception being bank 8, which contains the icon data and is only 1-bit deep (see Table 13).

Table 13 Y address pointer

Y[3]	Y[2]	Y[1]	Y[0]	BANK	ROWS
0	0	0	0	bank 0	R0 to R7
0	0	0	1	bank 1	R8 to R15
0	0	1	0	bank 2	R16 to R23
0	0	1	1	bank 3	R24 to R31
0	1	0	0	bank 4	R32 to R39
0	1	0	1	bank 5	R40 to R47
0	1	1	0	bank 6	R48 to R55
0	1	1	1	bank 7	R56 to R63
1	0	0	0	bank 8 (icons)	R64

65 × 133 pixel matrix driver

PCF8535

7.16.2.5 Set X address of RAM

The X address is used as a pointer to the RAM for RAM writing. The range of X is 0 to 127 and may be extended by the XM_0 bit. The combined value of XM_0 and X address directly corresponds to the display column number when $MX = 0$ and corresponds to the inverse display column number when $MX = 1$ (see Table 14).

Table 14 X address pointer

$XM_0, X[6:0]$	ADDRESSED COLUMN	
	$MX = 0$	$MX = 1$
0	C0	C132
1	C1	C131
2	C2	C130
3	C3	C129
:	:	:
129	C129	C3
130	C130	C2
131	C131	C1
132	C132	C0

7.16.3 DISPLAY SETTING COMMAND PAGE

7.16.3.1 Display control

The D and E bits set the display mode as given in Table 15.

Table 15 Display control

D	E	MODE
0	0	display blank
1	0	normal mode
0	1	all display segments on
1	1	inverse video

7.16.3.2 External display control

Mirror X and mirror Y have the effect of flipping the display left to right or top to bottom respectively. MX works by changing the order data that is written into the RAM. As such, the effects of toggling MX will only be seen after data is written into the RAM. MY works by reversing the order that column data is accessed relative to the row outputs. The effect of toggling MY will be seen immediately. The behaviour of both of these bits is further described in Section 7.15.

7.16.3.3 Bias system

BS[2:0] sets the bias system (see Section 7.10).

7.16.3.4 Display size

Physically large displays require stronger drivers. Bit IB enables the user to select a stronger driving mode and should be used if suitable display quality can not be achieved with the default setting.

7.16.3.5 Multiplex rate

M[2:0] sets the multiplex rate (see Section 7.9).

7.16.4 HV-GEN COMMAND PAGE

7.16.4.1 HV-gen control

PRS

Bit PRS selects the programmable charge pump range select. This bit defines whether the programmed voltage for V_{OP} is in the LOW or the HIGH range. The behaviour of this bit is further described in Section 7.13.

HVE

Bit HVE enables the high voltage generator. When set to logic 0, the charge pump is disabled. When set to logic 1, the charge pump is enabled.

7.16.4.2 HV-gen stages

S[1:0] set the multiplication factor of the charge pump ranging from times 2 to times 5. The behaviour of these bits is further described in Section 7.14.

7.16.4.3 Temperature coefficients

TC[2:0] set the required temperature coefficient. The behaviour of these bits is further described in Section 7.12.

7.16.4.4 Temperature measurement control

The SM bit is used to initiate a temperature measurement. The SM bit is automatically cleared at the end of the measurement. The behaviour of this bit is further described in Section 7.11.

7.16.4.5 V_{LCD} control

$V_{OP}[6:0]$ sets the required operating voltage for the display.

65 × 133 pixel matrix driver

PCF8535

7.16.5 SPECIAL FEATURE COMMAND PAGE

7.16.5.1 State control

DM

Direct mode allows V_{LCDOUT} to be sourced directly from V_{DD2} . This may be useful in systems where V_{DD} is to be used for V_{LCD} .

DOF

Display off will turn off all internal analog circuitry that is not required for temperature measurement.

As a consequence the display will be turned off. This mode is only required if temperature measurements are required whilst in Power-down mode.

7.16.5.2 Oscillator setting

The internal oscillator may be disabled and the source clock for the display is derived from the OSC pad. It is important to remember that LCDs are damaged by DC

voltages and that the clock, whether derived internally or externally, should never be disabled whilst the display is active. The internal oscillator is switched off during power-down mode.

Using an external clock and disabling it during power-down mode will further reduce the standby current. If it is not possible to disable it externally, then it is worth noting that by selecting the internal clock, which is disabled during power-down mode, the same effect may be achieved.

7.16.5.3 COG/TCP

The chip may be mounted on either a glass, foil or tape carrier package. For these applications, different organizations of the row pads are required to negate the necessity of routing tracks under the device. The TRS and BRS allow for this swapping. The behaviour of both of these bits is further described in Section 7.15.

7.16.6 INSTRUCTION SET

Table 16 Instruction set

INSTRUCTION	D/C	R/W ⁽¹⁾	I ² C-BUS COMMAND BYTE								I ² C-BUS COMMANDS	
			DB7	DB6	DB5	DB4	DB3	DB2	DB1	DB0		
H[2:0] = XXX; RAM read/write command page												
Write data	1	0	D ₇	D ₆	D ₅	D ₄	D ₃	D ₂	D ₁	D ₀	write data to display RAM	
Read status	0	1	D ₇	D ₆	D ₅	D ₄	D ₃	D ₂	D ₁	D ₀	return result of temperature measurement	
NOP	0	0	0	0	0	0	0	0	0	0	no operation	
Default H[2:0]	0	0	0	0	0	0	0	0	0	1	jump to H[2:0] = 111	
H[2:0] = 111; function and RAM command page												
Command page	0	0	0	0	0	0	1	H ₂	H ₁	H ₀	select command page	
Function set	0	0	0	0	0	1	0	PD	V	0	power-down control, data entry mode	
RAM page	0	0	0	0	1	0	0	XM ₀	0	0	set RAM page for X address	
Set Y address of RAM	0	0	0	1	0	0	0	Y ₃	Y ₂	Y ₁	Y ₀	set Y address of RAM 0 ≤ Y ≤ 8
Set X address of RAM	0	0	1	X ₆	X ₅	X ₄	X ₃	X ₂	X ₁	X ₀	set X address of RAM 0 ≤ X ≤ 127	
H[2:0] = 110; display setting command page												
Display control	0	0	0	0	0	0	0	1	D	E	set display mode	
External display control	0	0	0	0	0	0	1	MX	MY	0	mirror X, mirror Y	
Bias system	0	0	0	0	0	1	0	BS ₂	BS ₁	BS ₀	set bias system	

65 × 133 pixel matrix driver

PCF8535

INSTRUCTION	D/C	R/W ⁽¹⁾	I ² C-BUS COMMAND BYTE								I ² C-BUS COMMANDS
			DB7	DB6	DB5	DB4	DB3	DB2	DB1	DB0	
Display size	0	0	0	0	1	0	0	IB	0	0	set current for bias system
Multiplex rate	0	0	1	0	0	0	0	M ₂	M ₁	M ₀	set multiplex rate
H[2:0] = 101; HV-gen command page											
HV-gen control	0	0	0	0	0	0	0	1	PRS	HVE	select V _{LCD} programming range, enable/disable HV-gen
HV-gen stages	0	0	0	0	0	0	1	0	S ₁	S ₀	select HV-gen voltage multiplication factor
Temperature coefficients	0	0	0	0	0	1	0	TC2	TC1	TC0	set temperature coefficient
Temperature measurement control	0	0	0	0	1	0	0	0	0	SM	start temperature measurement
V _{LCD} control	0	0	1	V _{OP6}	V _{OP5}	V _{OP4}	V _{OP3}	V _{OP2}	V _{OP1}	V _{OP0}	set V _{LCD} register 0 ≤ V _{LCD} ≤ 127
H[2:0] = 011; special feature command page											
State control	0	0	0	0	0	0	0	1	DOF	DM	display off, direct mode
Oscillator setting	0	0	0	0	0	0	1	0	EC	0	enable/disable the internal oscillator
COG/TCP	0	0	0	1	0	TRS	BRS	0	0	0	top row swap, bottom row swap

Note

1. R/W is set in the slave address.

65 × 133 pixel matrix driver

PCF8535

Table 17 Description of the symbols used in Table 16

BIT	0	1
PD	chip is active	chip is in power-down mode
V	horizontal addressing	vertical addressing
HVE	voltage multiplier disabled	voltage multiplier enabled
PRS	V _{LCD} programming range LOW	V _{LCD} programming range HIGH
SM	no measurement	start measurement
MX	no X mirror	mirror X
MY	no Y mirror	mirror Y
TRS	top row swap inactive	top row swap active
BRS	bottom row swap inactive	bottom row swap active
EC	internal oscillator enabled; OSC pad ignored	internal oscillator disabled; OSC pad enabled for input
DM ⁽¹⁾	direct mode disabled	direct mode enabled
DOF ⁽¹⁾	display off mode disabled	display off mode enabled
IB	low current mode for smaller displays	high current mode for larger displays

Note

1. Conditional on other bits.

Table 18 Priority behaviour of bits PD, DOF, HVE and DM; note 1

PD	DOF	HVE	DM	MODE
1	X	X	X	chip is in power-down mode as defined under PD
0	1	X	X	all analog blocks except those required for temperature measurement are off
0	0	1	X	chip is active and using the internal V _{LCD} generator
0	0	0	1	chip is active and using V _{DD} as V _{LCD}
0	0	0	0	chip is active and using an external supply voltage attached to V _{LCDIN}

Note

1. X = don't care state.

65 × 133 pixel matrix driver

PCF8535

7.17 I²C-bus interface7.17.1 CHARACTERISTICS OF THE I²C-BUS

The I²C-bus is for bidirectional, two-line communication between different ICs or modules. The two lines are a serial data line (SDA) and a serial clock line (SCL). Both lines must be connected to a positive supply via a pull-up resistor. Data transfer may be initiated only when the bus is not busy.

7.17.1.1 Bit transfer

One data bit is transferred during each clock pulse. The data on the SDA line must remain stable during the HIGH period of the clock pulse as changes in the data line at this time will be interpreted as a control signal. Bit transfer is illustrated in Fig.21.

7.17.1.2 START and STOP conditions

Both data and clock lines remain HIGH when the bus is not busy. A HIGH-to-LOW transition of the data line, while the clock is HIGH, is defined as the START condition (S). A LOW-to-HIGH transition of the data line, while the clock is HIGH, is defined as the STOP condition (P). The START and STOP conditions are illustrated in Fig.22.

7.17.1.3 System configuration

The system configuration is illustrated in Fig.23:

- Transmitter: the device which sends the data to the bus
- Receiver: the device which receives the data from the bus

- Master: the device which initiates a transfer, generates clock signals and terminates a transfer
- Slave: the device addressed by a master
- Multi-master: more than one master can attempt to control the bus at the same time without corrupting the message
- Arbitration: procedure to ensure that, if more than one master simultaneously tries to control the bus, only one is allowed to do so and the message is not corrupted
- Synchronization: procedure to synchronize the clock signals of two or more devices.

7.17.1.4 Acknowledge

Each byte of 8 bits is followed by an acknowledge bit. The acknowledge bit is a HIGH signal put on the bus by the transmitter during which time the master generates an extra acknowledge related clock pulse. A slave receiver which is addressed must generate an acknowledge after the reception of each byte. Also a master receiver must generate an acknowledge after the reception of each byte that has been clocked out of the slave transmitter. The device that acknowledges must pull-down the SDA line during the acknowledge clock pulse, so that the SDA line is stable LOW during the HIGH period of the acknowledge related clock pulse (set-up and hold times must be taken into consideration). A master receiver must signal an end of data to the transmitter by not generating an acknowledge on the last byte that has been clocked out of the slave. In this event the transmitter must leave the data line HIGH to enable the master to generate a STOP condition. Acknowledgement on the I²C-bus is illustrated in Fig.24.

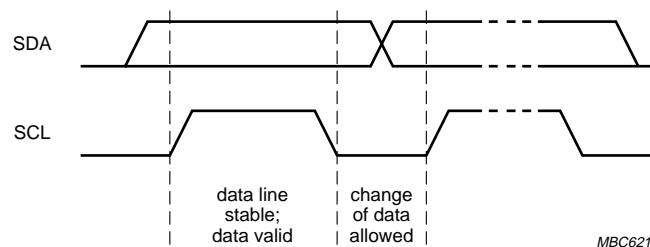
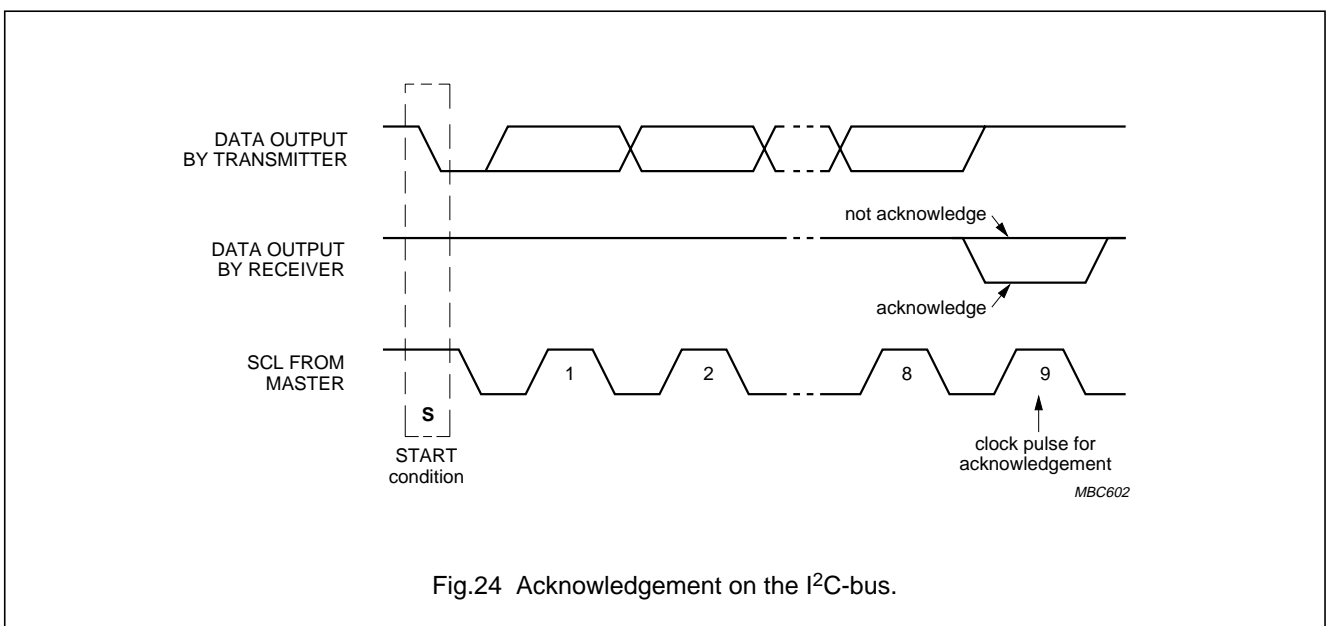
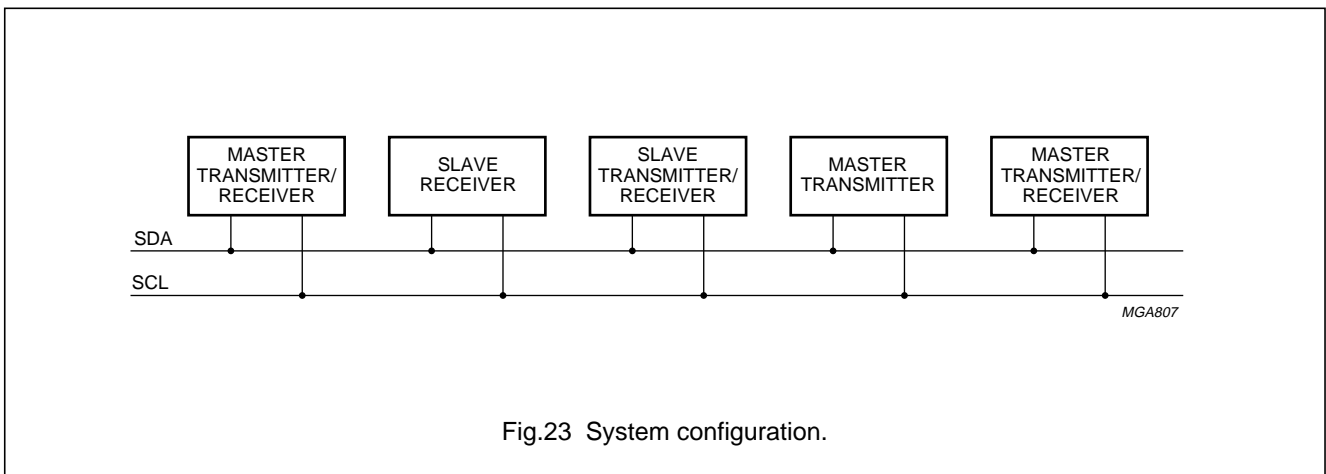
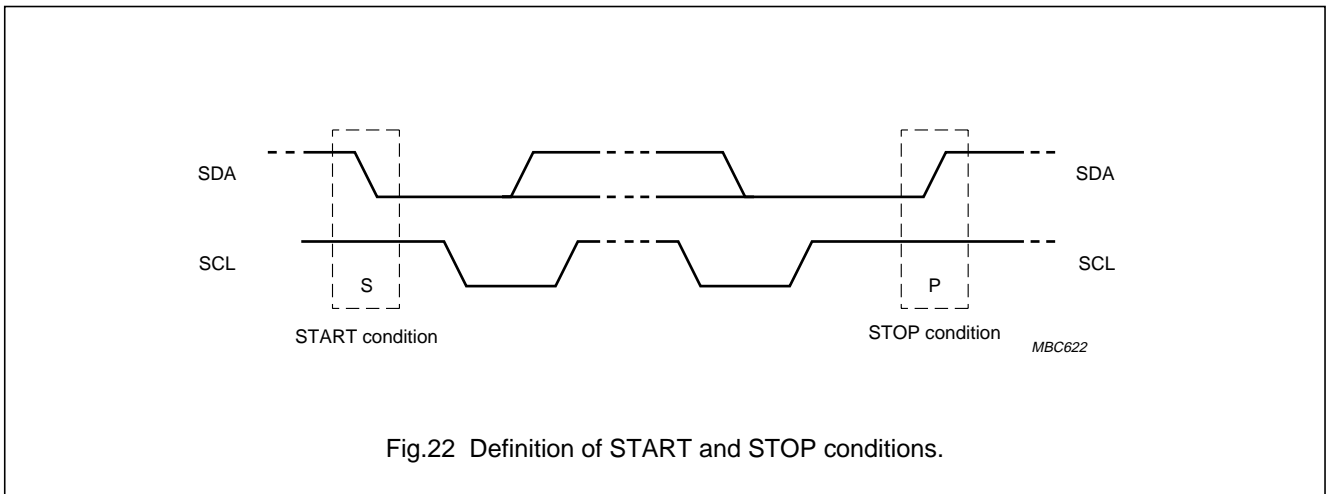

Fig.21 Bit transfer.

65 × 133 pixel matrix driver

PCF8535



65 × 133 pixel matrix driver

PCF8535

7.17.2 I²C-BUS PROTOCOL

The PCF8535 is a slave receiver/transmitter. If data is to be read from the device the SDAOUT pad must be connected, otherwise SDAOUT is unused.

Before any data is transmitted on the I²C-bus, the device which should respond is addressed. Four slave addresses, 0111100, 0111101, 0111110 and 0111111 are reserved for the PCF8535. The Least Significant Bits (LSBs) of the slave address is set by connecting SA1 and SA0 to either logic 0 (V_{SS}) or logic 1 (V_{DD}).

A sequence is initiated with a START condition (S) from the I²C-bus master which is followed by the slave address. All slaves with the corresponding address acknowledge in parallel, all the others will ignore the I²C-bus transfer.

After the acknowledgement cycle of a write, a control byte follows which defines the destination for the forthcoming data byte and the mode for subsequent bytes. For a read,

the PCF8535 will immediately start to output the requested data until a NOT acknowledge is transmitted by the master. The sequence should be terminated by a STOP in the event that no further access is required for the time being, or by a RE-START should further access be required.

For ease of operation a continuation bit Co has been included. This bit allows the user to set-up the chip configuration and transmit RAM data in one access. A data selection bit, D/C, defines the destination for data. These bits are contained in the control byte. DB5 to DB0 should be set to logic 0. These bits are reserved for future expansion.

An example of a write access is given in Fig.25. Here, multiple instruction data is sent, followed by multiple display bytes.

An example of a read access is given in Fig.26.

Table 19 Co and D/C definitions

BIT	VALUE	R/W	ACTION
Co	0	n.a.	last control byte to be sent and only a stream of data bytes are allowed to follow; this stream may only be terminated by a STOP or RE-START condition
	1	n.a.	another control byte will follow the data byte unless a STOP or RE-START condition is received
D/C	0	0	data byte will be decoded and used to set up the device
		1	data byte will return the contents of the currently selected status register
	1	0	data byte will be stored in the display RAM
		1	no provision for RAM read back is provided

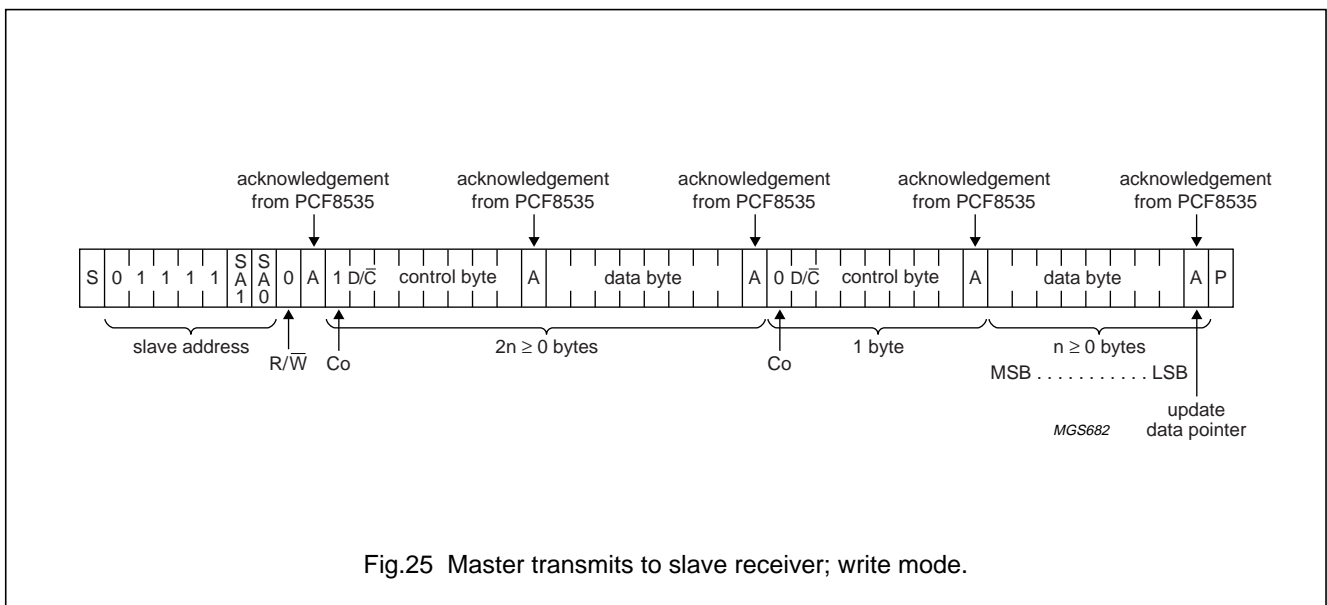
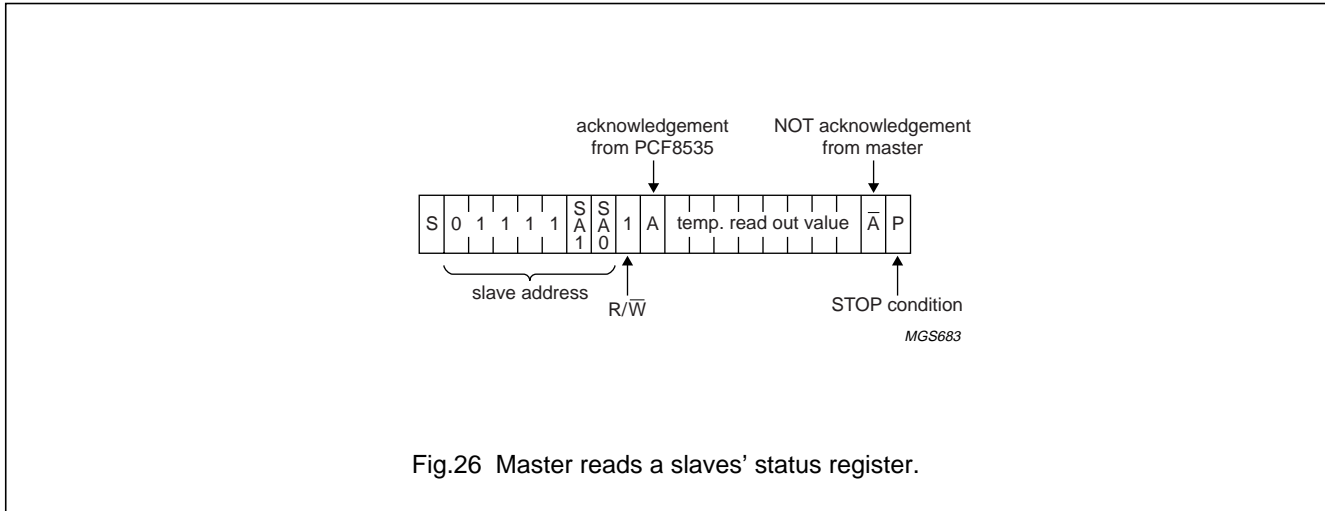

Fig.25 Master transmits to slave receiver; write mode.

65 × 133 pixel matrix driver

PCF8535



8 LIMITING VALUES

In accordance with the Absolute Maximum Rating System (IEC 60134); notes 1, 2 and 3.

SYMBOL	PARAMETER	MIN.	MAX.	UNIT
V _{DD}	supply voltage	-0.5	+7.0	V
I _{DD}	supply current	-50	+50	mA
V _{LCD}	LCD supply voltage	-0.5	+17.0	V
I _{LCD}	LCD supply current	-50	+50	mA
I _{SS}	negative supply current	-50	+50	mA
V _I	input voltage (any input)	-0.5	V _{DD} + 0.5	V
V _O	output voltage (any output)	-0.5	V _{DD} + 0.5	V
I _I	DC input current	-10	+10	mA
I _O	DC output current	-10	+10	mA
P _{tot}	total power dissipation per package	-	300	mW
P/out	power dissipation per output	-	30	mW
T _{amb}	ambient temperature	-40	+85	°C
T _{stg}	storage temperature	-65	+150	°C
T _{j(max)}	maximum junction temperature	-	150	°C

Notes

1. Stresses above these values listed may cause permanent damage to the device.
2. Parameters are valid over the operating temperature range unless otherwise specified. All voltages are referenced to V_{SS} unless otherwise specified.
3. V_{SS} = 0 V.

9 HANDLING

Inputs and outputs are protected against electrostatic discharge in normal handling. However, to be totally safe, it is recommended to take normal precautions appropriate to handling MOS devices (see "Handling MOS Devices").

65 × 133 pixel matrix driver

PCF8535

10 DC CHARACTERISTICS

$V_{DD} = 4.5$ to 5.5 V; $V_{SS} = 0$ V; $V_{LCD} = 4.5$ to 16.0 V; $T_{amb} = -40$ to $+85$ °C; all voltages referenced to V_{SS} ; unless otherwise specified.

SYMBOL	PARAMETER	CONDITIONS	MIN.	TYP.	MAX.	UNIT
Supplies						
V_{LCDIN}	LCD supply voltage	all Mux modes	4.5	–	16.0	V
I_{LCDIN}	I_{LCD} ; LCD supply current	power-down; note 1	–	0	10	μ A
		display active; Mux 1:65, bias 1/9; $V_{LCDIN} = 12$ V; notes 1 and 2	–	63	125	μ A
		display active; Mux 1:17, bias 1/5; $V_{LCDIN} = 5$ V; notes 1 and 2	–	44	88	μ A
V_{LCDOUT}	generated LCD supply voltage	LCD voltage generator enabled	–	–	16.0	V
V_{DD}	supply voltage		4.5	–	5.5	V
I_{DD}	I_{DD} ; V_{DD} supply current	power-down; note 1	–	2	10	μ A
		display active; $V_{LCDIN} = 12$ V; Mux 1:65, bias 1/9; notes 1 and 2	–	30	60	μ A
		display active; $V_{LCDOUT} = 12$ V; times 3 multiplier; Mux 1:65; bias 1/9; notes 1 and 2	–	315	630	μ A
		display active; $V_{LCDIN} = 5$ V; Mux 1:17; bias 1/5; notes 1 and 2	–	22	45	μ A
		display active; direct mode; Mux 1:17, bias 1/5; notes 1 and 2	–	95	190	μ A
Logic						
V_{IL}	LOW-level input voltage		V_{SS}	–	$0.3V_{DD}$	V
V_{IH}	HIGH-level input voltage		$0.7V_{DD}$	–	V_{DD}	V
I_{OL}	LOW-level output current (SDA)	$V_{OL} = 0.4$ V; $V_{DD} = 5$ V	3.0	–	–	mA
I_L	leakage current	$V_I = V_{DD}$ or V_{SS}	–1	–	+1	μ A
Column and row outputs						
$R_{o(col)}$	column output resistance C0 to C132	$V_{LCD} = 12$ V; note 3	–	–	10	k Ω
$R_{o(row)}$	row output resistance R0 to R64	$V_{LCD} = 12$ V; note 3	–	–	3.0	k Ω
$V_{bias(col)}$	bias tolerance C0 to C132		–100	0	+100	mV
$V_{bias(row)}$	bias tolerance R0 to R64		–100	0	+100	mV
LCD supply voltage generator						
$V_{LCD(tol)}$	V_{LCD} tolerance (internal V_{LCD})	$T_{amb} = -20$ to $+85$ °C; $V_{LCD} \leq 12$ V	–	–	4.6	%
Temperature coefficient						
T_{cut}	cut point temperature		–	27	–	°C

Notes

- LCD outputs are open-circuit, inputs at V_{DD} or V_{SS} , bus inactive, f_{OSC} = typical internal oscillator frequency.
- Conditions are: V_{DD1} to $V_{DD3} = 5.0$ V; $I_B = 0$; $D = 1$; $E = 0$; internal oscillator and RAM contains all 0s.
- $I_{LCD} = 10$ μ A. Outputs tested one at a time.

65 × 133 pixel matrix driver

PCF8535

11 AC CHARACTERISTICS

$V_{DD} = 4.5$ to 5.5 V; $V_{SS} = 0$ V; $V_{LCD} = 4.5$ to 16.0 V; $T_{amb} = -40$ to $+85$ °C; unless otherwise specified.

SYMBOL	PARAMETER	CONDITIONS	MIN.	TYP.	MAX.	UNIT
Frequencies						
$f_{fr(LCD)}$	LCD frame frequency (internal clock)		48	80	165	Hz
$f_{clk(ext)}$	external clock frequency	see Table 20	120	–	410	kHz
Reset tuning (see Fig.28)						
$t_{W(RESL)}$	reset LOW pulse width		1	–	–	μs
$t_{W(RESH)}$	reset HIGH pulse width		5	–	–	μs
$t_{SU;RESL}$	reset LOW pulse set-up time after power-on	notes 1 and 2	–	–	30	μs
$t_{R(op)}$	end of reset pulse to interface being operational		–	–	3	μs
Serial-bus interface; note 3 (see Fig.27)						
f_{SCL}	SCL clock frequency		0	–	400	kHz
t_{LOW}	SCL LOW time		1.3	–	–	μs
t_{HIGH}	SCL HIGH time		0.6	–	–	μs
$t_{SU;DAT}$	data set-up time		100	–	–	ns
$t_{HD;DAT}$	data hold time		0	–	0.9	μs
t_r	rise time SDA and SCL	note 4	$20 + 0.1C_b$	–	300	ns
t_f	fall time SDA and SCL	note 4	$20 + 0.1C_b$	–	300	ns
C_b	capacitive load represented by each bus line		–	–	400	pF
$t_{SU;STA}$	set-up time repeated START		0.6	–	–	μs
$t_{HD;STA}$	hold time START condition		0.6	–	–	μs
$t_{SU;STO}$	set-up time STOP condition		0.6	–	–	μs
t_{SP}	tolerable spike width on bus		–	–	50	ns
t_{BUF}	bus free time (between a STOP and START condition)		1.3	–	–	μs

Notes

- V_{DD1} to $V_{DD3} = 5$ V.
- Decoupling capacitor on V_{LCD} and V_{SS} is 100 nF (higher capacitor value increases $t_{SU;RESL}$ and higher V_{DD1} to V_{DD3} reduces $t_{SU;RESL}$).
- All timing values are valid within the operating supply voltage and ambient temperature range and are referenced to V_{IL} and V_{IH} with an input voltage swing of V_{SS} to V_{DD} .
- C_b is total capacitance of one bus line in pF.

65 × 133 pixel matrix driver

PCF8535

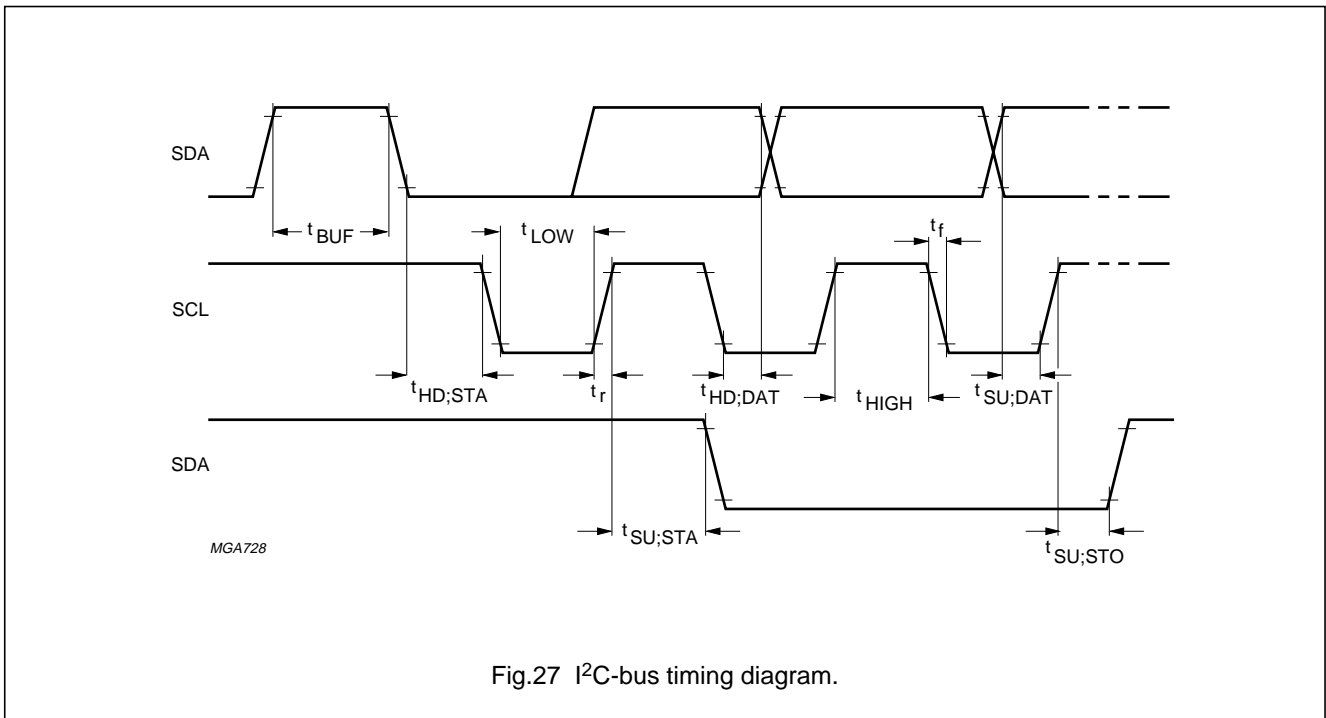

Fig.27 I²C-bus timing diagram.

Table 20 External clock frequency for an 80 Hz frame frequency

MUX MODE	DIVISION RATIO	EXTERNAL CLOCK FREQUENCY
1 : 65	3168	253 kHz
1 : 48	3136	251 kHz
1 : 34	2720	218 kHz
1 : 26	2592	207 kHz
1 : 17	2592	207 kHz

65 × 133 pixel matrix driver

PCF8535

12 RESET TIMING

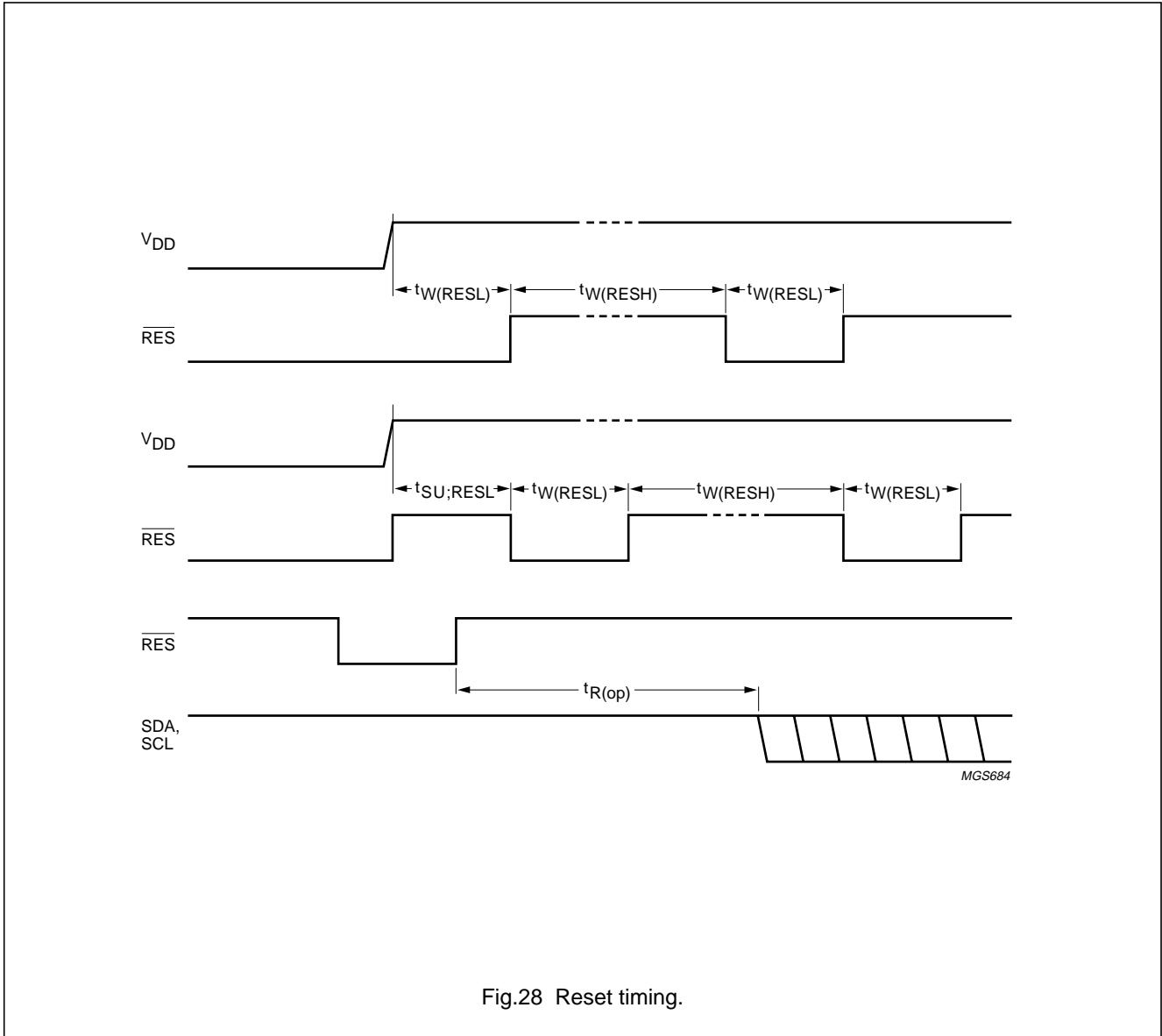

Fig.28 Reset timing.

65 × 133 pixel matrix driver

PCF8535

13 APPLICATION INFORMATION

Table 21 Programming example for PCF8535

STEP	SERIAL BUS BYTE	DISPLAY ⁽¹⁾	OPERATION
1	START condition	BLANK	start
2	DB7 DB6 DB5 DB4 DB3 DB2 DB1 DB0 0 1 1 1 1 SA1 SA0 0	BLANK	slave address, $R/\overline{W} = 0$
3	DB7 DB6 DB5 DB4 DB3 DB2 DB1 DB0 0 0 0 0 0 0 0 0	BLANK	control byte, $Co = 0, D/\overline{C} = 0$
4	DB7 DB6 DB5 DB4 DB3 DB2 DB1 DB0 0 0 0 0 0 0 0 1	BLANK	H[2:0] independent command; select function and RAM command page H[1:0] = 111
5	DB7 DB6 DB5 DB4 DB3 DB2 DB1 DB0 0 0 0 1 0 0 0 0	BLANK	function and RAM command page; PD = 0, V = 0
6	DB7 DB6 DB5 DB4 DB3 DB2 DB1 DB0 0 0 0 0 1 1 1 0	BLANK	function and RAM command page; select display setting command page H[1:0] = 110
7	DB7 DB6 DB5 DB4 DB3 DB2 DB1 DB0 0 0 0 1 0 0 1 0	BLANK	display setting command page; set bias system to $1/9$ (BS[2:0] = 010)
8	DB7 DB6 DB5 DB4 DB3 DB2 DB1 DB0 0 0 0 0 0 1 1 0	BLANK	display setting command page; set normal mode (D = 1, E = 0)
9	DB7 DB6 DB5 DB4 DB3 DB2 DB1 DB0 1 0 0 0 0 1 0 0	BLANK	select Mux rate 1 : 65
10	DB7 DB6 DB5 DB4 DB3 DB2 DB1 DB0 0 0 0 0 0 0 0 1	BLANK	H[2:0] independent command; select function and RAM command page H[1:0] = 111
11	DB7 DB6 DB5 DB4 DB3 DB2 DB1 DB0 0 0 0 0 1 1 0 1	BLANK	function and RAM command page; select HV-gen command page H[2:0] = 101
12	DB7 DB6 DB5 DB4 DB3 DB2 DB1 DB0 0 0 0 0 1 0 0 1	BLANK	HV-gen command page; select voltage multiplication factor 3 S[1:0] = 01
13	DB7 DB6 DB5 DB4 DB3 DB2 DB1 DB0 0 0 0 1 0 0 1 0	BLANK	HV-gen command page; select temperature coefficient 2 TC[2:0] = 010
14	DB7 DB6 DB5 DB4 DB3 DB2 DB1 DB0 1 0 1 0 1 0 0 0	BLANK	HV-gen command page; set $V_{LCD} = 12.02$ V; $V_{OP}[6:0] = 0101000$
15	DB7 DB6 DB5 DB4 DB3 DB2 DB1 DB0 0 0 0 0 0 1 1 1	BLANK	HV-gen command page; select HIGH V_{LCD} programming range (PRS = 1), voltage multiplier on (HVE = 1)
16	START condition	BLANK	repeat start
17	DB7 DB6 DB5 DB4 DB3 DB2 DB1 DB0 0 1 1 1 1 SA1 SA0 0	BLANK	slave address, $R/\overline{W} = 0$

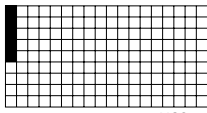
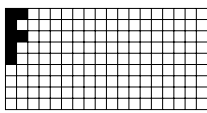
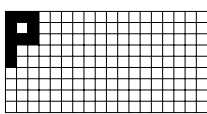
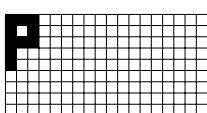
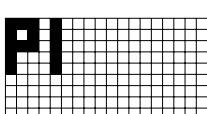
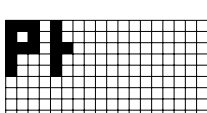
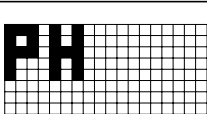
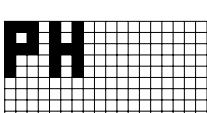

65 × 133 pixel matrix driver

PCF8535

STEP	SERIAL BUS BYTE	DISPLAY ⁽¹⁾	OPERATION
18	DB7 DB6 DB5 DB4 DB3 DB2 DB1 DB0 0 1 0 0 0 0 0 0	BLANK	control byte, Co = 0, D/C = 1
19	DB7 DB6 DB5 DB4 DB3 DB2 DB1 DB0 0 0 0 1 1 1 1 1	 <small>MGS405</small>	data write; Y, X are initialized to logic 0 by default, so they are not set here
20	DB7 DB6 DB5 DB4 DB3 DB2 DB1 DB0 0 0 0 0 0 1 0 1	 <small>MGS406</small>	data write
21	DB7 DB6 DB5 DB4 DB3 DB2 DB1 DB0 0 0 0 0 0 1 1 1	 <small>MGS407</small>	data write
22	DB7 DB6 DB5 DB4 DB3 DB2 DB1 DB0 0 0 0 0 0 0 0 0	 <small>MGS408</small>	data write
23	DB7 DB6 DB5 DB4 DB3 DB2 DB1 DB0 0 0 0 1 1 1 1 1	 <small>MGS409</small>	data write
24	DB7 DB6 DB5 DB4 DB3 DB2 DB1 DB0 0 0 0 0 0 1 0 0	 <small>MGS410</small>	data write
25	DB7 DB6 DB5 DB4 DB3 DB2 DB1 DB0 0 0 0 1 1 1 1 1	 <small>MGS411</small>	data write, last data, stop transmission
26	START condition		repeat start
27	DB7 DB6 DB5 DB4 DB3 DB2 DB1 DB0 0 1 1 1 1 SA1 SA0 0	 <small>MGS411</small>	slave address, R/W = 0

65 × 133 pixel matrix driver

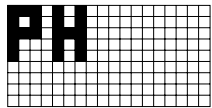
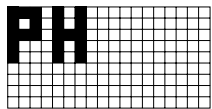
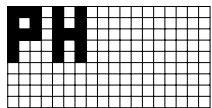
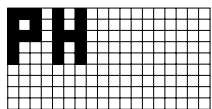
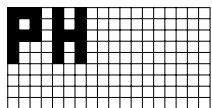
PCF8535

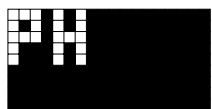
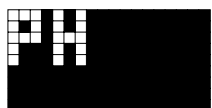
STEP	SERIAL BUS BYTE	DISPLAY ⁽¹⁾	OPERATION
28	DB7 DB6 DB5 DB4 DB3 DB2 DB1 DB0 1 0 0 0 0 0 0 0		control byte, Co = 1, D/C = 0
29	DB7 DB6 DB5 DB4 DB3 DB2 DB1 DB0 0 0 0 0 0 0 0 0		H[2:0] independent command; select function and RAM command page H[2:0] = 111
30	DB7 DB6 DB5 DB4 DB3 DB2 DB1 DB0 1 0 0 0 0 0 0 0		control byte, Co = 1, D/C = 0 function and RAM command page; select display setting command page H[2:0] = 110
31	DB7 DB6 DB5 DB4 DB3 DB2 DB1 DB0 0 0 0 0 1 1 1 0		
32	DB7 DB6 DB5 DB4 DB3 DB2 DB1 DB0 1 0 0 0 0 0 0 0		control byte, Co = 1, D/C = 0
33	DB7 DB6 DB5 DB4 DB3 DB2 DB1 DB0 0 0 0 0 1 1 0 1		display control; set inverse video mode (D = 1, E = 1)
34	DB7 DB6 DB5 DB4 DB3 DB2 DB1 DB0 1 0 0 0 0 0 0 0		control byte, Co = 1, D/C = 0
35	DB7 DB6 DB5 DB4 DB3 DB2 DB1 DB0 1 0 0 0 0 0 0 0		set X address of RAM; set address to '000000'

65 × 133 pixel matrix driver

PCF8535

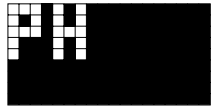
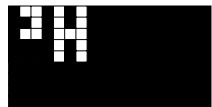
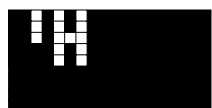
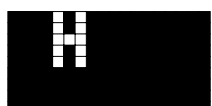
STEP	SERIAL BUS BYTE	DISPLAY ⁽¹⁾	OPERATION
36	DB7 DB6 DB5 DB4 DB3 DB2 DB1 DB0 0 1 0 0 0 0 0 0	 <p>MGS412</p>	control byte, Co = 0, D/C = 1
37	DB7 DB6 DB5 DB4 DB3 DB2 DB1 DB0 0 0 0 0 0 0 0 0	 <p>MGS414</p>	data write
38	DB7 DB6 DB5 DB4 DB3 DB2 DB1 DB0 0 0 0 0 0 0 0 0	 <p>MGS685</p>	data write
39	DB7 DB6 DB5 DB4 DB3 DB2 DB1 DB0 0 0 0 0 0 0 0 0	 <p>MGS686</p>	data write
40	STOP condition		end of transfer

Note

1. Assumes the display RAM was previously empty.

65 × 133 pixel matrix driver

PCF8535

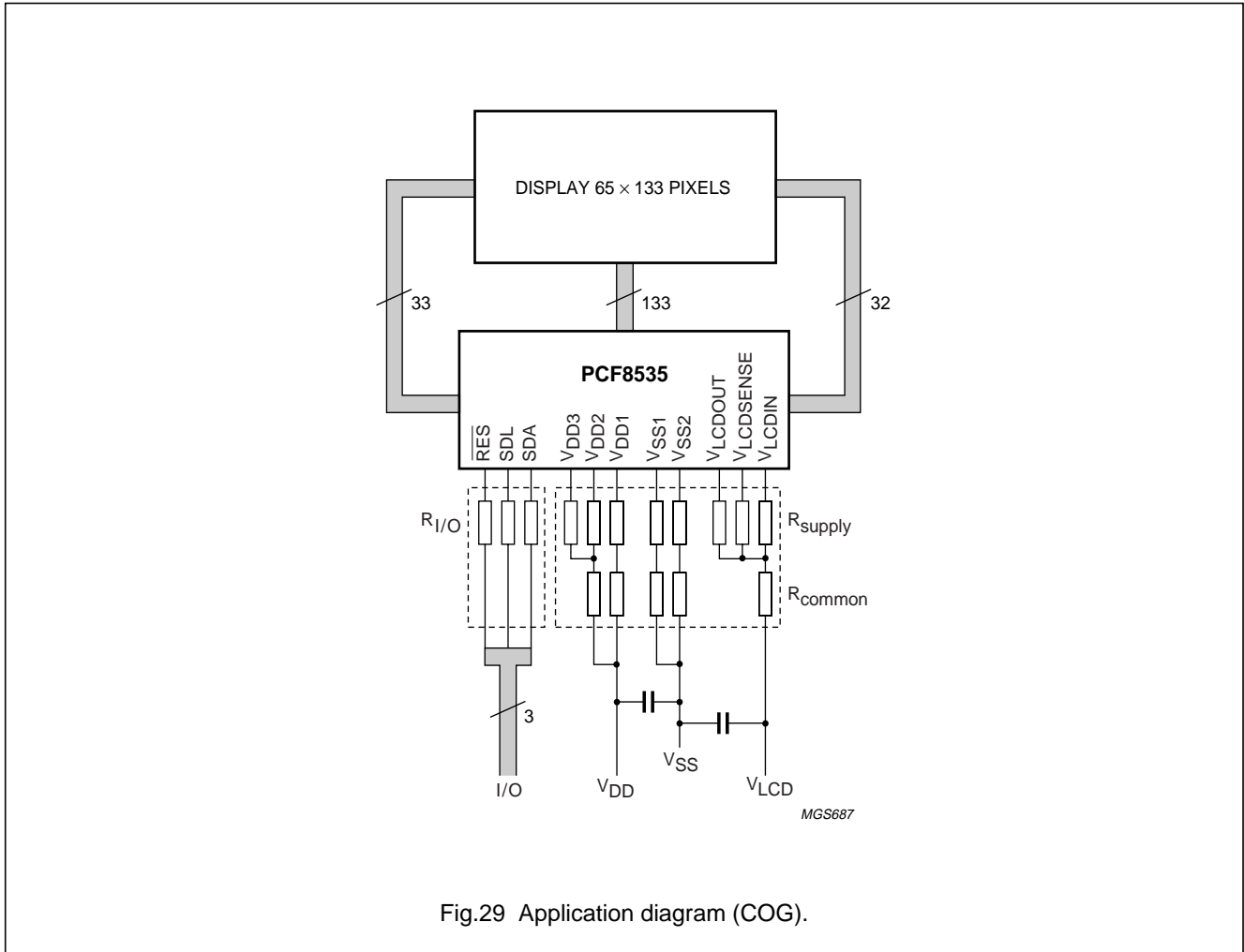

Fig.29 Application diagram (COG).

13.1 Application for chip-on-glass

The pinning of the PCF8535 is optimized for single plane wiring e.g. for chip-on-glass display modules.

The required minimum value for the external capacitors in an application with the PCF8535 are:

Between V_{LCD} and V_{SS} is 100 nF (min.) (recommended 470 nF to 1 μ F): Between V_{DD} and V_{SS} is 470 nF (recommended capacitor larger than the capacitor between V_{LCD} and V_{SS}).

Higher capacitor values are recommended for ripple reduction.

For COG applications the recommended ITO track resistance is to be minimized for the I/O and supply

connections. Maximum resistance for supply tracks (R_{supply}) are 120 Ω . Maximum values for the common resistance to the source (R_{common}) are 120 Ω . Higher track resistance reduces performance and increases current consumption.

Three I/O lines are required for the COG module: SDA, SCL and \overline{RES} (optional). Other signals may be fixed on the module to appropriate levels. $R_{I/O}$ should also be minimized. In particular, if the I²C-bus acknowledge or temperature read back is required, the $R_{I/O}$ for the SDA line must be carefully considered in conjunction with the value of the external pull-up resistor.

Inputs SA0, SA1, OSC, T4, T5 and \overline{RES} are CMOS inputs and hence may be routed to V_{SS} or V_{DD} using relatively high track impedances e.g. up to 100 k Ω .

65 × 133 pixel matrix driver

PCF8535

14 BONDING PAD LOCATIONS

Table 22 Bonding pad locations

All x and y coordinates are referenced to the centre of the chip (dimensions in μm ; see Fig.33).

SYMBOL	PAD	x	y
dummy	1	+1050	-6156
bump/align 1	2	+1050	-6081
R0	3	+1050	-5985
R1	4	+1050	-5915
R2	5	+1050	-5845
R3	6	+1050	-5775
R4	7	+1050	-5705
R5	8	+1050	-5635
R6	9	+1050	-5565
R7	10	+1050	-5495
R8	11	+1050	-5425
R9	12	+1050	-5355
R10	13	+1050	-5285
R11	14	+1050	-5215
R12	15	+1050	-5145
R13	16	+1050	-5075
R14	17	+1050	-5005
R15	18	+1050	-4935
C0	19	+1050	-4725
C1	20	+1050	-4655
C2	21	+1050	-4585
C3	22	+1050	-4515
C4	23	+1050	-4445
C5	24	+1050	-4305
C6	25	+1050	-4235
C7	26	+1050	-4165
C8	27	+1050	-4095
C9	28	+1050	-4025
C10	29	+1050	-3955
C11	30	+1050	-3885
C12	31	+1050	-3815
C13	32	+1050	-3745
C14	33	+1050	-3675
C15	34	+1050	-3605
C16	35	+1050	-3535
C17	36	+1050	-3465
C18	37	+1050	-3395

SYMBOL	PAD	x	y
C19	38	+1050	-3325
C20	39	+1050	-3255
C21	40	+1050	-3185
C22	41	+1050	-3115
C23	42	+1050	-3045
C24	43	+1050	-2975
C25	44	+1050	-2905
C26	45	+1050	-2835
C27	46	+1050	-2765
C28	47	+1050	-2695
C29	48	+1050	-2625
C30	49	+1050	-2555
C31	50	+1050	-2485
C32	51	+1050	-2415
C33	52	+1050	-2345
C34	53	+1050	-2275
C35	54	+1050	-2205
C36	55	+1050	-2135
C37	56	+1050	-1995
C38	57	+1050	-1925
C39	58	+1050	-1855
C40	59	+1050	-1785
C41	60	+1050	-1715
C42	61	+1050	-1645
C43	62	+1050	-1575
C44	63	+1050	-1505
C45	64	+1050	-1435
C46	65	+1050	-1365
C47	66	+1050	-1295
C48	67	+1050	-1225
C49	68	+1050	-1155
C50	69	+1050	-1085
C51	70	+1050	-1015
C52	71	+1050	-945
C53	72	+1050	-875
C54	73	+1050	-805
C55	74	+1050	-735
C56	75	+1050	-665
C57	76	+1050	-595
C58	77	+1050	-525
C59	78	+1050	-455

65 × 133 pixel matrix driver

PCF8535

SYMBOL	PAD	x	y
C60	79	+1050	-385
C61	80	+1050	-315
C62	81	+1050	-245
C63	82	+1050	-175
C64	83	+1050	-105
C65	84	+1050	-35
C66	85	+1050	+35
C67	86	+1050	+105
C68	87	+1050	+175
C69	88	+1050	+315
C70	89	+1050	+385
C71	90	+1050	+455
C72	91	+1050	+525
C73	92	+1050	+595
C74	93	+1050	+665
C75	94	+1050	+735
C76	95	+1050	+805
C77	96	+1050	+875
C78	97	+1050	+945
C79	98	+1050	+1015
C80	99	+1050	+1085
C81	100	+1050	+1155
C82	101	+1050	+1225
C83	102	+1050	+1295
C84	103	+1050	+1365
C85	104	+1050	+1435
C86	105	+1050	+1505
C87	106	+1050	+1575
C88	107	+1050	+1645
C89	108	+1050	+1715
C90	109	+1050	+1785
C91	110	+1050	+1855
C92	111	+1050	+1925
C93	112	+1050	+1995
C94	113	+1050	+2065
C95	114	+1050	+2135
C96	115	+1050	+2205
C97	116	+1050	+2275
C98	117	+1050	+2345
C99	118	+1050	+2415
C100	119	+1050	+2485

SYMBOL	PAD	x	y
C101	120	+1050	+2625
C102	121	+1050	+2695
C103	122	+1050	+2765
C104	123	+1050	+2835
C105	124	+1050	+2905
C106	125	+1050	+2975
C107	126	+1050	+3045
C108	127	+1050	+3115
C109	128	+1050	+3185
C110	129	+1050	+3255
C111	130	+1050	+3325
C112	131	+1050	+3395
C113	132	+1050	+3465
C114	133	+1050	+3535
C115	134	+1050	+3605
C116	135	+1050	+3675
C117	136	+1050	+3745
C118	137	+1050	+3815
C119	138	+1050	+3885
C120	139	+1050	+3955
C121	140	+1050	+4025
C122	141	+1050	+4095
C123	142	+1050	+4165
C124	143	+1050	+4235
C125	144	+1050	+4305
C126	145	+1050	+4375
C127	146	+1050	+4445
C128	147	+1050	+4515
C129	148	+1050	+4585
C130	149	+1050	+4655
C131	150	+1050	+4725
C132	151	+1050	+4795
R47	152	+1050	+5005
R46	153	+1050	+5075
R45	154	+1050	+5145
R44	155	+1050	+5215
R43	156	+1050	+5285
R42	157	+1050	+5355
R41	158	+1050	+5425
R40	159	+1050	+5495
R39	160	+1050	+5565

65 × 133 pixel matrix driver

PCF8535

SYMBOL	PAD	x	y
R38	161	+1050	+5635
R37	162	+1050	+5705
R36	163	+1050	+5775
R35	164	+1050	+5845
R34	165	+1050	+5915
R33	166	+1050	+5985
bump/align 2	167	+1050	+6081
dummy	168	-1050	+6094
R48	169	-1050	+5954
R49	170	-1050	+5884
R50	171	-1050	+5814
R51	172	-1050	+5744
R52	173	-1050	+5674
R53	174	-1050	+5604
R54	175	-1050	+5534
R55	176	-1050	+5464
R56	177	-1050	+5394
R57	178	-1050	+5324
R58	179	-1050	+5254
R59	180	-1050	+5184
R60	181	-1050	+5114
R61	182	-1050	+5044
R62	183	-1050	+4974
R63	184	-1050	+4904
R64	185	-1050	+4834
bump/align 3	186	-1050	+4414
dummy	187	-1050	+4274
dummy	188	-1050	+3996
dummy	189	-1050	+3574
OSC	190	-1050	+3154
V _{LCDIN}	191	-1050	+2874
V _{LCDIN}	192	-1050	+2804
V _{LCDIN}	193	-1050	+2734
V _{LCDIN}	194	-1050	+2664
V _{LCDIN}	195	-1050	+2594
V _{LCDIN}	196	-1050	+2524
V _{LCDOUT}	197	-1050	+2384
V _{LCDOUT}	198	-1050	+2314
V _{LCDOUT}	199	-1050	+2244
V _{LCDOUT}	200	-1050	+2174
V _{LCDOUT}	201	-1050	+2104

SYMBOL	PAD	x	y
V _{LCDOUT}	202	-1050	+2034
V _{LCDOUT}	203	-1050	+1964
V _{LCDSENCE}	204	-1050	+1894
dummy	205	-1050	+1544
dummy	206	-1050	+1264
RES	207	-1050	+914
T3	208	-1050	+704
T2	209	-1050	+494
T1	210	-1050	+284
V _{DD2}	211	-1050	+144
V _{DD2}	212	-1050	+74
V _{DD2}	213	-1050	+4
V _{DD2}	214	-1050	-66
V _{DD2}	215	-1050	-136
V _{DD2}	216	-1050	-206
V _{DD2}	217	-1050	-276
V _{DD2}	218	-1050	-346
V _{DD3}	219	-1050	-416
V _{DD3}	220	-1050	-486
V _{DD3}	221	-1050	-556
V _{DD3}	222	-1050	-626
V _{DD1}	223	-1050	-696
V _{DD1}	224	-1050	-766
V _{DD1}	225	-1050	-836
V _{DD1}	226	-1050	-906
V _{DD1}	227	-1050	-976
V _{DD1}	228	-1050	-1046
dummy	229	-1050	-1186
SDA	230	-1050	-1466
SDA	231	-1050	-1536
SDAOUT	232	-1050	-1886
SA1	233	-1050	-2166
SA0	234	-1050	-2376
V _{SS2}	235	-1050	-2586
V _{SS2}	236	-1050	-2656
V _{SS2}	237	-1050	-2726
V _{SS2}	238	-1050	-2796
V _{SS2}	239	-1050	-2866
V _{SS2}	240	-1050	-2936
V _{SS2}	241	-1050	-3006
V _{SS2}	242	-1050	-3076

65 × 133 pixel matrix driver

PCF8535

SYMBOL	PAD	x	y
V _{SS1}	243	-1050	-3146
V _{SS1}	244	-1050	-3216
V _{SS1}	245	-1050	-3286
V _{SS1}	246	-1050	-3356
V _{SS1}	247	-1050	-3426
V _{SS1}	248	-1050	-3496
V _{SS1}	249	-1050	-3566
V _{SS1}	250	-1050	-3636
T5	251	-1050	-3846
T4	252	-1050	-4056
dummy	253	-1050	-4126
SCL	254	-1050	-4406
SCL	255	-1050	-4476
bump/align 4	256	-1050	-4605
R32	257	-1050	-4826
R31	258	-1050	-4896
R30	259	-1050	-4966
R29	260	-1050	-5036
R28	261	-1050	-5106
R27	262	-1050	-5176
R26	263	-1050	-5246
R25	264	-1050	-5316
R24	265	-1050	-5386
R23	266	-1050	-5456
R22	267	-1050	-5526
R21	268	-1050	-5596
R20	269	-1050	-5666
R19	270	-1050	-5736
R18	271	-1050	-5806
R17	272	-1050	-5876
R16	273	-1050	-5946

Table 23 Alignment marks

MARKS	x	y
Alignment mark 1	-1045	-4720
Alignment mark 2	-1045	+4620
Alignment mark 3	+1045	+6196
Alignment mark 4	+1045	-6196
Dummy bump/alignment mark 1	+1050	-6081
Dummy bump/alignment mark 2	+1050	+6081
Dummy bump/alignment mark 3	-1050	+4414
Dummy bump/alignment mark 4	-1050	-4605
Bottom left	-1180	-6330
Top right	+1180	+6330

Table 24 Dimensions

PAD	SIZE	UNIT
Pad pitch	minimum 70 (see Fig.32)	μm
Pad size; Al	62 × 100 (see Fig.32)	μm
CBB opening	36 × 76 (see Fig.32)	μm
Bump dimensions	50 × 90 × 17.5 (± 5)	μm
Wafer thickness	381 ± 25	μm
Alignment mark	φ100 (see Fig.30)	μm
Dummy/alignment mark	φ80 (see Fig.31)	μm
Wafer dimensions	12.660 x 2360 (see Fig.32)	μm

65 × 133 pixel matrix driver

PCF8535

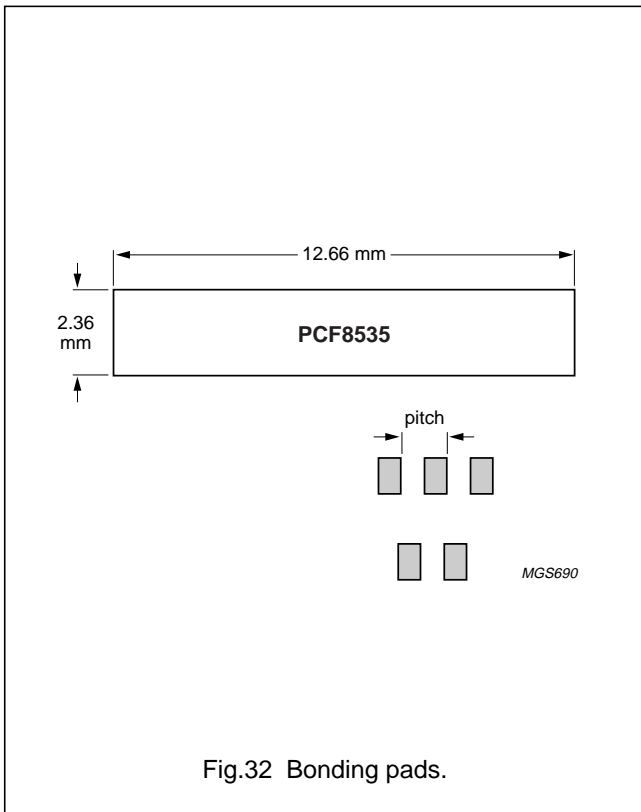
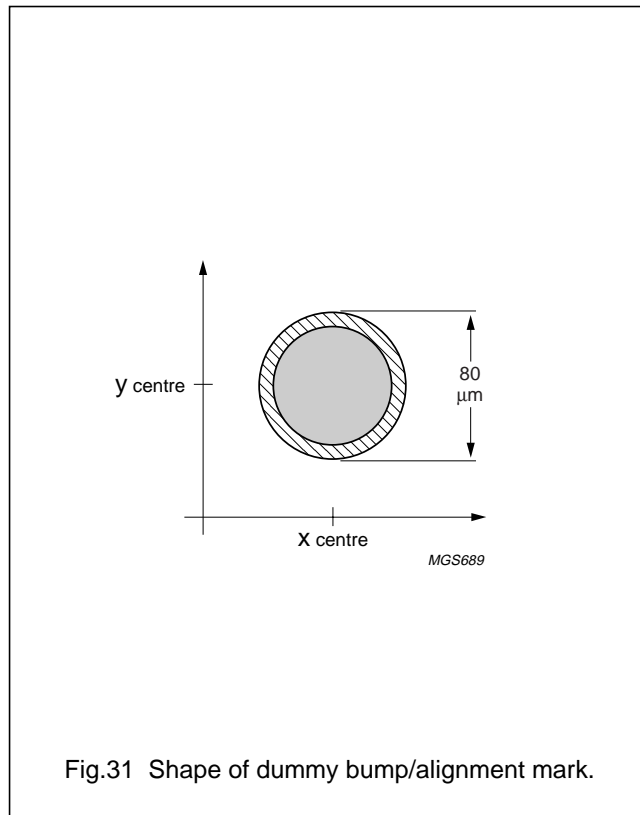
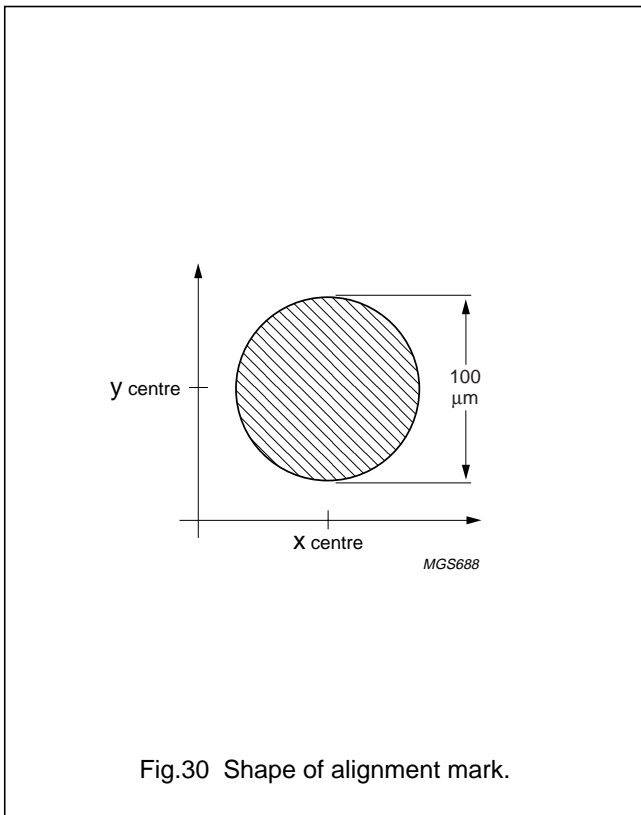

65 × 133 pixel matrix driver

PCF8535

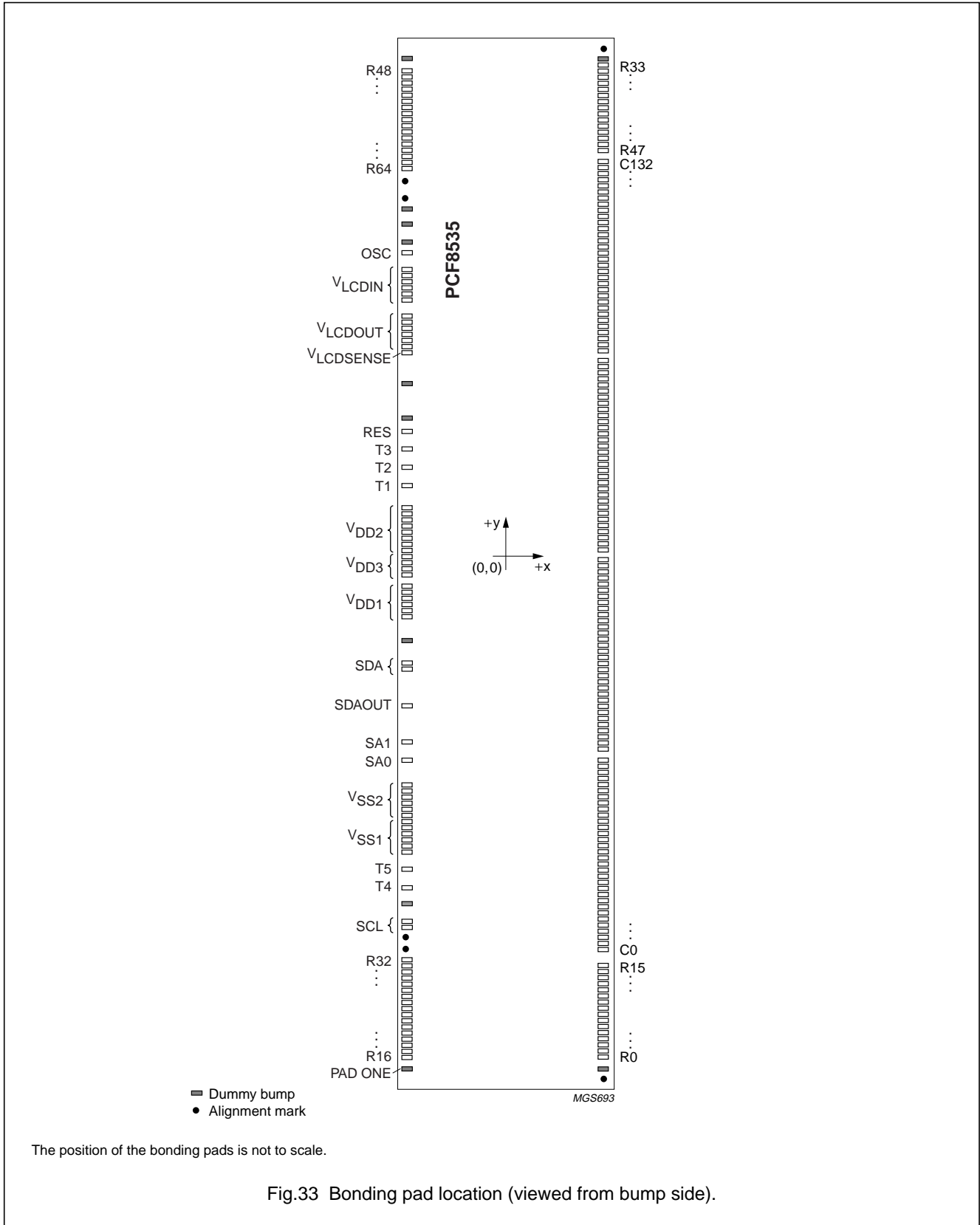

The position of the bonding pads is not to scale.

Fig.33 Bonding pad location (viewed from bump side).

65 × 133 pixel matrix driver

PCF8535

15 DEVICE PROTECTION

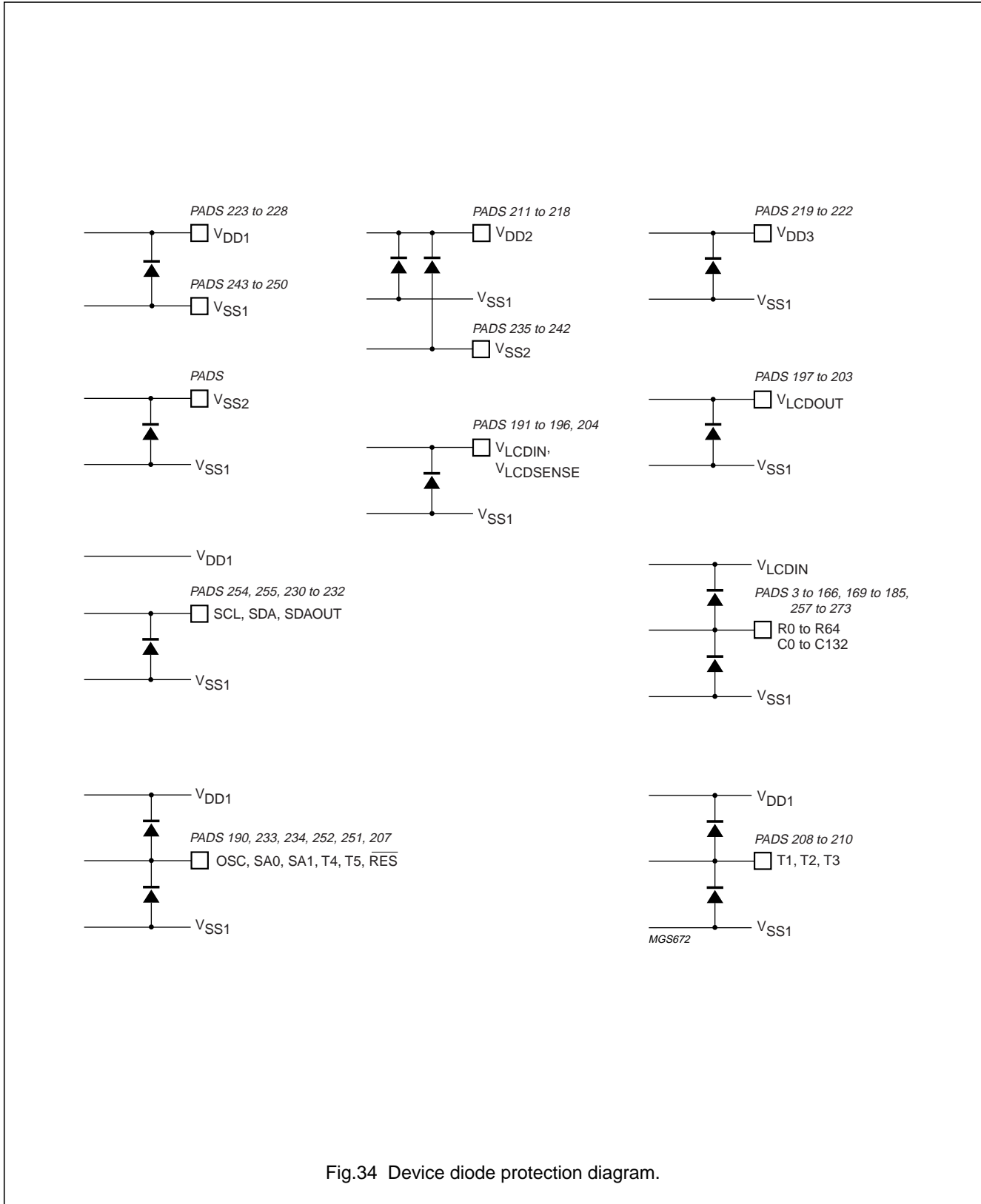

Fig.34 Device diode protection diagram.

65 × 133 pixel matrix driver

PCF8535

16 TRAY INFORMATION

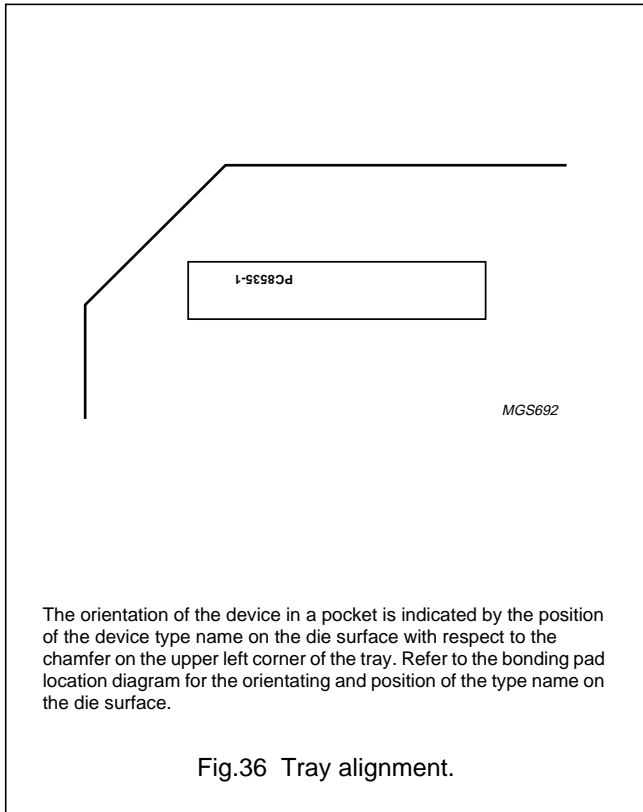
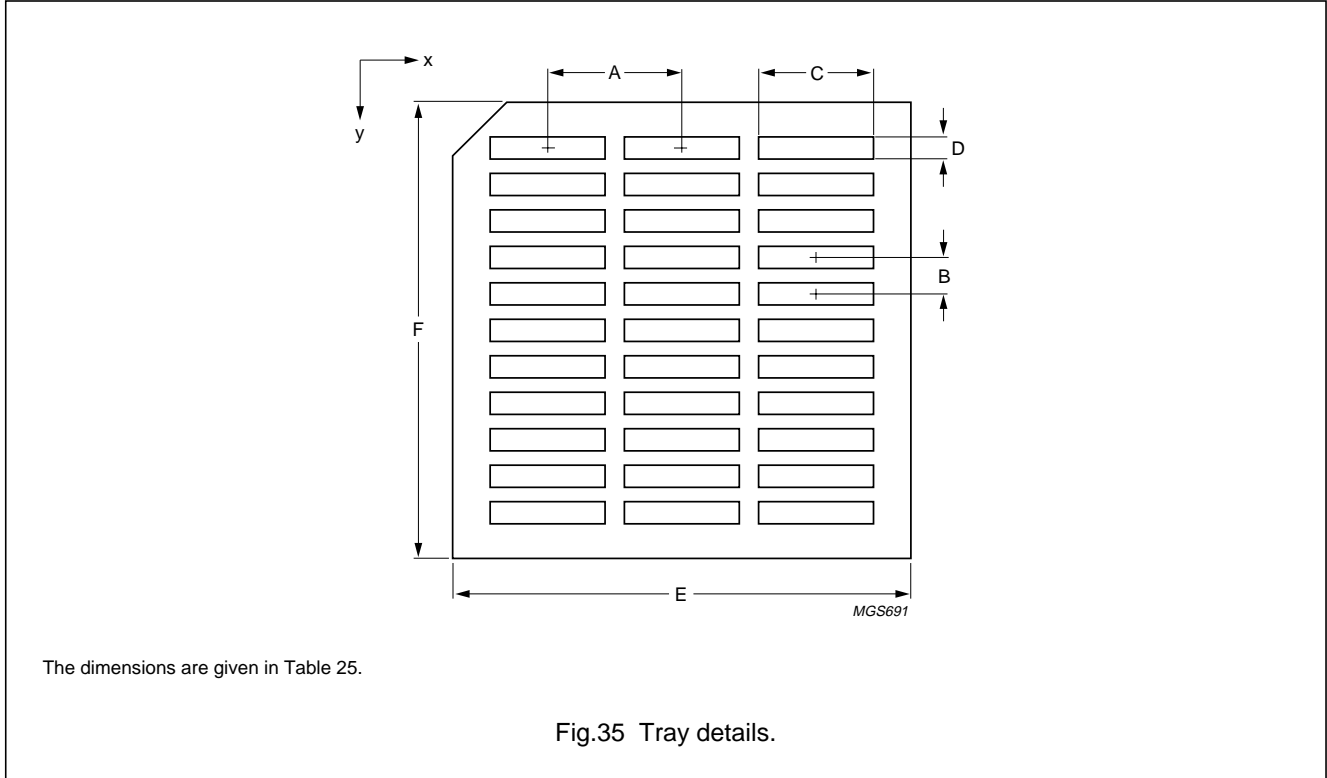

Table 25 Tray dimensions

DIM.	DESCRIPTION	VALUE
A	pocket pitch in x direction	14.88 mm
B	pocket pitch in y direction	4.06 mm
C	pocket width in x direction	12.76 mm
D	pocket width in y direction	2.46 mm
E	tray width in x direction	50.8 mm
F	tray width in y direction	50.8 mm
x	number of pockets in x direction	3
y	number of pockets in y direction	11

65 × 133 pixel matrix driver

PCF8535

17 DATA SHEET STATUS

DATA SHEET STATUS ⁽¹⁾	PRODUCT STATUS ⁽²⁾	DEFINITIONS
Objective data	Development	This data sheet contains data from the objective specification for product development. Philips Semiconductors reserves the right to change the specification in any manner without notice.
Preliminary data	Qualification	This data sheet contains data from the preliminary specification. Supplementary data will be published at a later date. Philips Semiconductors reserves the right to change the specification without notice, in order to improve the design and supply the best possible product.
Product data	Production	This data sheet contains data from the product specification. Philips Semiconductors reserves the right to make changes at any time in order to improve the design, manufacturing and supply. Changes will be communicated according to the Customer Product/Process Change Notification (CPCN) procedure SNW-SQ-650A.

Notes

1. Please consult the most recently issued data sheet before initiating or completing a design.
2. The product status of the device(s) described in this data sheet may have changed since this data sheet was published. The latest information is available on the Internet at URL <http://www.semiconductors.philips.com>.

18 DEFINITIONS

Short-form specification — The data in a short-form specification is extracted from a full data sheet with the same type number and title. For detailed information see the relevant data sheet or data handbook.

Limiting values definition — Limiting values given are in accordance with the Absolute Maximum Rating System (IEC 60134). Stress above one or more of the limiting values may cause permanent damage to the device. These are stress ratings only and operation of the device at these or at any other conditions above those given in the Characteristics sections of the specification is not implied. Exposure to limiting values for extended periods may affect device reliability.

Application information — Applications that are described herein for any of these products are for illustrative purposes only. Philips Semiconductors make no representation or warranty that such applications will be suitable for the specified use without further testing or modification.

19 DISCLAIMERS

Life support applications — These products are not designed for use in life support appliances, devices, or systems where malfunction of these products can reasonably be expected to result in personal injury. Philips Semiconductors customers using or selling these products for use in such applications do so at their own risk and agree to fully indemnify Philips Semiconductors for any damages resulting from such application.

Right to make changes — Philips Semiconductors reserves the right to make changes, without notice, in the products, including circuits, standard cells, and/or software, described or contained herein in order to improve design and/or performance. Philips Semiconductors assumes no responsibility or liability for the use of any of these products, conveys no licence or title under any patent, copyright, or mask work right to these products, and makes no representations or warranties that these products are free from patent, copyright, or mask work right infringement, unless otherwise specified.

65 × 133 pixel matrix driver**PCF8535**

20 PURCHASE OF PHILIPS I²C COMPONENTS

Purchase of Philips I²C components conveys a license under the Philips' I²C patent to use the components in the I²C system provided the system conforms to the I²C specification defined by Philips. This specification can be ordered using the code 9398 393 40011.

21 BARE DIE DISCLAIMER

All die are tested and are guaranteed to comply with all data sheet limits up to the point of wafer sawing for a period of ninety (90) days from the date of Philips' delivery. If there are data sheet limits not guaranteed, these will be separately indicated in the data sheet. There is no post waffle pack testing performed on individual die. Although the most modern processes are utilized for wafer sawing and die pick and place into waffle pack carriers, Philips Semiconductors has no control of third party procedures in the handling, packing or assembly of the die. Accordingly, Philips Semiconductors assumes no liability for device functionality or performance of the die or systems after handling, packing or assembly of the die. It is the responsibility of the customer to test and qualify their application in which the die is used.

65 × 133 pixel matrix driver

PCF8535

NOTES

65 × 133 pixel matrix driver

PCF8535

NOTES

65 × 133 pixel matrix driver

PCF8535

NOTES

Philips Semiconductors – a worldwide company

Contact information

For additional information please visit <http://www.semiconductors.philips.com>. Fax: +31 40 27 24825

For sales offices addresses send e-mail to: sales.addresses@www.semiconductors.philips.com.

© Koninklijke Philips Electronics N.V. 2001

SCA73

All rights are reserved. Reproduction in whole or in part is prohibited without the prior written consent of the copyright owner.

The information presented in this document does not form part of any quotation or contract, is believed to be accurate and reliable and may be changed without notice. No liability will be accepted by the publisher for any consequence of its use. Publication thereof does not convey nor imply any license under patent- or other industrial or intellectual property rights.

Printed in The Netherlands

403512/02/pp56

Date of release: 2001 Nov 07

Document order number: 9397 750 08229

Let's make things better.

**Philips
Semiconductors**



PHILIPS