

# MC33501, MC33503

## 1.0 V, Rail-to-Rail, Single Operational Amplifiers

The MC33501/503 operational amplifier provides rail-to-rail operation on both the input and output. The output can swing within 50 mV of each rail. This rail-to-rail operation enables the user to make full use of the entire supply voltage range available. It is designed to work at very low supply voltages (1.0 V and ground), yet can operate with a supply of up to 7.0 V and ground. Output current boosting techniques provide high output current capability while keeping the drain current of the amplifier to a minimum.

### Features

- Low Voltage, Single Supply Operation (1.0 V and Ground to 7.0 V and Ground)
- High Input Impedance: Typically 40 fA Input Bias Current
- Typical Unity Gain Bandwidth @ 5.0 V = 4.0 MHz, @ 1.0 V = 3.0 MHz
- High Output Current ( $I_{SC} = 40 \text{ mA @ } 5.0 \text{ V}$ ,  $13 \text{ mA @ } 1.0 \text{ V}$ )
- Output Voltage Swings within 50 mV of Both Rails @ 1.0 V
- Input Voltage Range Includes Both Supply Rails
- High Voltage Gain: 100 dB Typical @ 1.0 V
- No Phase Reversal on the Output for Over-Driven Input Signals
- Typical Input Offset of 0.5 mV
- Low Supply Current ( $I_D = 1.2 \text{ mA/per Amplifier}$ , Typical)
- 600  $\Omega$  Drive Capability
- Extended Operating Temperature Range (-40 to 105°C)
- Pb-Free Packages are Available

### Applications

- Single Cell NiCd/Ni MH Powered Systems
- Interface to DSP
- Portable Communication Devices
- Low Voltage Active Filters
- Telephone Circuits
- Instrumentation Amplifiers
- Audio Applications
- Power Supply Monitor and Control
- Transistor Count: 98



**ON Semiconductor®**

<http://onsemi.com>

### MARKING DIAGRAM

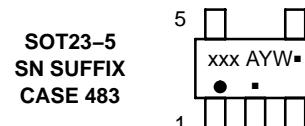

**SOT23-5  
SN SUFFIX  
CASE 483**

xxx = AAA; MC33501  
 AAB; MC33503  
 A = Assembly Location  
 Y = Year  
 WW = Work Week  
 ■ = Pb-Free Package

(Note: Microdot may be in either location)

### PIN CONNECTIONS

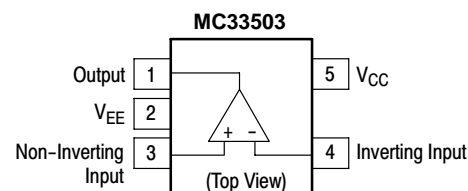
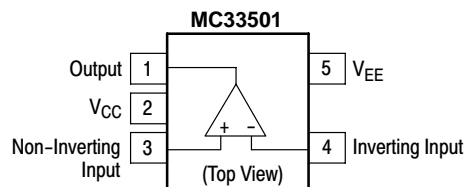

### ORDERING INFORMATION

| Device       | Package           | Shipping†        |
|--------------|-------------------|------------------|
| MC33501SNT1  | SOT23-5           | 3000 Tape & Reel |
| MC33501SNT1G | SOT23-5 (Pb-Free) | 3000 Tape & Reel |
| MC33503SNT1  | SOT23-5           | 3000 Tape & Reel |
| MC33503SNT1G | SOT23-5 (Pb-Free) | 3000 Tape & Reel |

†For information on tape and reel specifications, including part orientation and tape sizes, please refer to our Tape and Reel Packaging Specifications Brochure, BRD8011/D.

# MC33501, MC33503

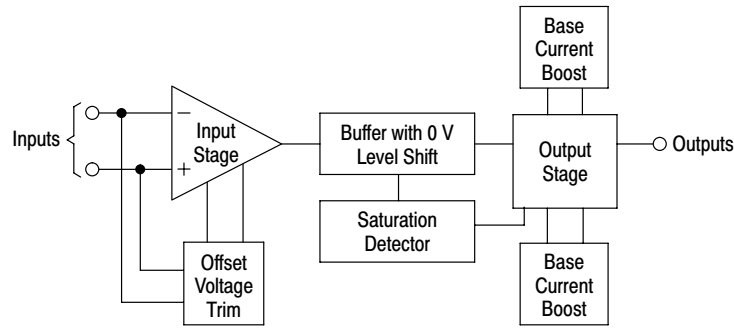

This device contains 98 active transistors per amplifier.

**Figure 1. Simplified Block Diagram**

## MAXIMUM RATINGS

| Rating  | Symbol    | Value                | Unit |
|---|-----------|----------------------|------|
| Supply Voltage ( $V_{CC}$ to $V_{EE}$ )               | $V_S$     | 7.0                  | V    |
| ESD Protection Voltage at any Pin<br>Human Body Model | $V_{ESD}$ | 2000                 | V    |
| Voltage at Any Device Pin                             | $V_{DP}$  | $V_S \pm 0.3$        | V    |
| Input Differential Voltage Range                      | $V_{IDR}$ | $V_{CC}$ to $V_{EE}$ | V    |
| Common Mode Input Voltage Range                       | $V_{CM}$  | $V_{CC}$ to $V_{EE}$ | V    |
| Output Short Circuit Duration                         | $t_S$     | Note 1               | s    |
| Maximum Junction Temperature                          | $T_J$     | 150                  | °C   |
| Storage Temperature Range                             | $T_{stg}$ | -65 to 150           | °C   |
| Maximum Power Dissipation                             | $P_D$     | Note 1               | mW   |

Stresses exceeding Maximum Ratings may damage the device. Maximum Ratings are stress ratings only. Functional operation above the Recommended Operating Conditions is not implied. Extended exposure to stresses above the Recommended Operating Conditions may affect device reliability.

1. Power dissipation must be considered to ensure maximum junction temperature ( $T_J$ ) is not exceeded.
2. ESD data available upon request.

# MC33501, MC33503

**DC ELECTRICAL CHARACTERISTICS** ( $V_{CC} = 5.0\text{ V}$ ,  $V_{EE} = 0\text{ V}$ ,  $V_{CM} = V_O = V_{CC}/2$ ,  $R_L$  to  $V_{CC}/2$ ,  $T_A = 25^\circ\text{C}$ , unless otherwise noted.)

| Characteristic   | Symbol                   | Min          | Typ          | Max        | Unit                         |
|--|--------------------------|--------------|--------------|------------|------------------------------|
| Input Offset Voltage ( $V_{CM} = 0$ to $V_{CC}$ )<br>$V_{CC} = 1.0\text{ V}$<br>$T_A = 25^\circ\text{C}$<br>$T_A = -40^\circ$ to $105^\circ\text{C}$<br>$V_{CC} = 3.0\text{ V}$<br>$T_A = 25^\circ\text{C}$<br>$T_A = -40^\circ$ to $105^\circ\text{C}$<br>$V_{CC} = 5.0\text{ V}$<br>$T_A = 25^\circ\text{C}$<br>$T_A = -40^\circ$ to $105^\circ\text{C}$   | $V_{IO}$                 | -5.0<br>-7.0 | 0.5<br>-     | 5.0<br>7.0 | mV                           |
| Input Offset Voltage Temperature Coefficient ( $R_S = 50\ \Omega$ )<br>$T_A = -40^\circ$ to $105^\circ\text{C}$  | $\Delta V_{IO}/\Delta T$ | -            | 8.0          | -          | $\mu\text{V}/^\circ\text{C}$ |
| Input Bias Current ( $V_{CC} = 1.0$ to $5.0\text{ V}$ )  | $ I_{IB} $               | -            | 0.00004      | 1.0        | nA                           |
| Common Mode Input Voltage Range  | $V_{ICR}$                | $V_{EE}$     | -            | $V_{CC}$   | V                            |
| Large Signal Voltage Gain<br>$V_{CC} = 1.0\text{ V}$ ( $T_A = 25^\circ\text{C}$ )<br>$R_L = 10\text{ k}\Omega$<br>$R_L = 1.0\text{ k}\Omega$<br>$V_{CC} = 3.0\text{ V}$ ( $T_A = 25^\circ\text{C}$ )<br>$R_L = 10\text{ k}\Omega$<br>$R_L = 1.0\text{ k}\Omega$<br>$V_{CC} = 5.0\text{ V}$ ( $T_A = 25^\circ\text{C}$ )<br>$R_L = 10\text{ k}\Omega$<br>$R_L = 1.0\text{ k}\Omega$   | $A_{VOL}$                | 25<br>5.0    | 100<br>50    | -<br>-     | kV/V                         |
| Output Voltage Swing, High ( $V_{ID} = \pm 0.2\text{ V}$ )<br>$V_{CC} = 1.0\text{ V}$ ( $T_A = 25^\circ\text{C}$ )<br>$R_L = 10\text{ k}\Omega$<br>$R_L = 600\ \Omega$<br>$V_{CC} = 1.0\text{ V}$ ( $T_A = -40^\circ$ to $105^\circ\text{C}$ )<br>$R_L = 10\text{ k}\Omega$<br>$R_L = 600\ \Omega$<br>$V_{CC} = 3.0\text{ V}$ ( $T_A = 25^\circ\text{C}$ )<br>$R_L = 10\text{ k}\Omega$<br>$R_L = 600\ \Omega$<br>$V_{CC} = 3.0\text{ V}$ ( $T_A = -40^\circ$ to $105^\circ\text{C}$ )<br>$R_L = 10\text{ k}\Omega$<br>$R_L = 600\ \Omega$<br>$V_{CC} = 5.0\text{ V}$ ( $T_A = 25^\circ\text{C}$ )<br>$R_L = 10\text{ k}\Omega$<br>$R_L = 600\ \Omega$<br>$V_{CC} = 5.0\text{ V}$ ( $T_A = -40^\circ$ to $105^\circ\text{C}$ )<br>$R_L = 10\text{ k}\Omega$<br>$R_L = 600\ \Omega$ | $V_{OH}$                 | 0.9<br>0.85  | 0.95<br>0.88 | -<br>-     | V                            |

# MC33501, MC33503

**DC ELECTRICAL CHARACTERISTICS (continued)** ( $V_{CC} = 5.0\text{ V}$ ,  $V_{EE} = 0\text{ V}$ ,  $V_{CM} = V_O = V_{CC}/2$ ,  $R_L$  to  $V_{CC}/2$ ,  $T_A = 25^\circ\text{C}$ , unless otherwise noted.)

| Characteristic  | Symbol   | Min  | Typ   | Max  | Unit |
|---|----------|--|---|--|------|
| Output Voltage Swing, Low ( $V_{ID} = \pm 0.2\text{ V}$ )<br>$V_{CC} = 1.0\text{ V}$ ( $T_A = 25^\circ\text{C}$ )<br>$R_L = 10\text{ k}\Omega$<br>$R_L = 600\ \Omega$<br>$V_{CC} = 1.0\text{ V}$ ( $T_A = -40^\circ$ to $105^\circ\text{C}$ )<br>$R_L = 10\text{ k}\Omega$<br>$R_L = 600\ \Omega$<br>$V_{CC} = 3.0\text{ V}$ ( $T_A = 25^\circ\text{C}$ )<br>$R_L = 10\text{ k}\Omega$<br>$R_L = 600\ \Omega$<br>$V_{CC} = 3.0\text{ V}$ ( $T_A = -40^\circ$ to $105^\circ\text{C}$ )<br>$R_L = 10\text{ k}\Omega$<br>$R_L = 600\ \Omega$<br>$V_{CC} = 5.0\text{ V}$ ( $T_A = 25^\circ\text{C}$ )<br>$R_L = 10\text{ k}\Omega$<br>$R_L = 600\ \Omega$<br>$V_{CC} = 5.0\text{ V}$ ( $T_A = -40^\circ$ to $105^\circ\text{C}$ )<br>$R_L = 10\text{ k}\Omega$<br>$R_L = 600\ \Omega$ | $V_{OL}$ | 0.05<br>0.1<br>0.1<br>0.15<br>0.05<br>0.1<br>0.1<br>0.15<br>0.05<br>0.1<br>0.1<br>0.15<br>0.1<br>0.2 | 0.02<br>0.05<br>–<br>–<br>0.02<br>0.08<br>–<br>–<br>0.02<br>0.1<br>–<br>–<br>–<br>– | –<br>–<br>–<br>–<br>–<br>–<br>–<br>–<br>–<br>–<br>–<br>–<br>–<br>– | V    |
| Common Mode Rejection ( $V_{in} = 0$ to $5.0\text{ V}$ )  | CMR      | 60   | 75  | –  | dB   |
| Power Supply Rejection<br>$V_{CC}/V_{EE} = 5.0\text{ V/Ground}$ to $3.0\text{ V/Ground}$  | PSR      | 60   | 75  | –  | dB   |
| Output Short Circuit Current ( $V_{in}$ Diff = $\pm 1.0\text{ V}$ )<br>$V_{CC} = 1.0\text{ V}$<br>Source<br>Sink<br>$V_{CC} = 3.0\text{ V}$<br>Source<br>Sink<br>$V_{CC} = 5.0\text{ V}$<br>Source<br>Sink  | $I_{SC}$ | 6.0<br>10<br>15<br>40<br>20<br>40  | 13<br>13<br>32<br>64<br>40<br>70  | 26<br>26<br>60<br>140<br>140<br>140                                | mA   |
| Power Supply Current (Per Amplifier, $V_O = 0\text{ V}$ )<br>$V_{CC} = 1.0\text{ V}$<br>$V_{CC} = 3.0\text{ V}$<br>$V_{CC} = 5.0\text{ V}$<br>$V_{CC} = 1.0\text{ V}$ ( $T_A = -40$ to $105^\circ\text{C}$ )<br>$V_{CC} = 3.0\text{ V}$ ( $T_A = -40$ to $105^\circ\text{C}$ )<br>$V_{CC} = 5.0\text{ V}$ ( $T_A = -40$ to $105^\circ\text{C}$ )  | $I_D$    | –<br>–<br>–<br>–<br>–<br>–   | 1.2<br>1.5<br>1.65<br>–<br>–<br>–   | 1.75<br>2.0<br>2.25<br>2.0<br>2.25<br>2.5                          | mA   |

# MC33501, MC33503

**AC ELECTRICAL CHARACTERISTICS** ( $V_{CC} = 5.0\text{ V}$ ,  $V_{EE} = 0\text{ V}$ ,  $V_{CM} = V_O = V_{CC}/2$ ,  $T_A = 25^\circ\text{C}$ , unless otherwise noted.)

| Characteristic  | Symbol        | Min               | Typ               | Max               | Unit                   |
|---|---------------|-------------------|-------------------|-------------------|------------------------|
| Slew Rate ( $V_S = \pm 2.5\text{ V}$ , $V_O = -2.0\text{ to }2.0\text{ V}$ , $R_L = 2.0\text{ k}\Omega$ , $A_V = 1.0$ )<br>Positive Slope<br>Negative Slope   | SR            | 1.8<br>1.8        | 3.0<br>3.0        | 6.0<br>6.0        | V/ $\mu\text{s}$       |
| Gain Bandwidth Product ( $f = 100\text{ kHz}$ )<br>$V_{CC} = 0.5\text{ V}$ , $V_{EE} = -0.5\text{ V}$<br>$V_{CC} = 1.5\text{ V}$ , $V_{EE} = -1.5\text{ V}$<br>$V_{CC} = 2.5\text{ V}$ , $V_{EE} = -2.5\text{ V}$ | GBW           | 2.0<br>2.5<br>3.0 | 3.0<br>3.5<br>4.0 | 6.0<br>7.0<br>8.0 | MHz                    |
| Gain Margin ( $R_L = 10\text{ k}\Omega$ , $C_L = 0\text{ pF}$ )   | $A_m$         | -                 | 6.5               | -                 | dB                     |
| Phase Margin ( $R_L = 10\text{ k}\Omega$ , $C_L = 0\text{ pF}$ )  | $\phi_m$      | -                 | 60                | -                 | Deg                    |
| Channel Separation ( $f = 1.0\text{ Hz to }20\text{ kHz}$ , $R_L = 600\ \Omega$ )   | CS            | -                 | 120               | -                 | dB                     |
| Power Bandwidth ( $V_O = 4.0\text{ V}_{pp}$ , $R_L = 1.0\text{ k}\Omega$ , $\text{THD} \leq 1.0\%$ )  | $\text{BW}_P$ | -                 | 200               | -                 | kHz                    |
| Total Harmonic Distortion ( $V_O = 4.5\text{ V}_{pp}$ , $R_L = 600\ \Omega$ , $A_V = 1.0$ )<br>$f = 1.0\text{ kHz}$<br>$f = 10\text{ kHz}$  | THD           | -<br>-            | 0.004<br>0.01     | -<br>-            | %                      |
| Differential Input Resistance ( $V_{CM} = 0\text{ V}$ )   | $R_{in}$      | -                 | >1.0              | -                 | terra $\Omega$         |
| Differential Input Capacitance ( $V_{CM} = 0\text{ V}$ )  | $C_{in}$      | -                 | 2.0               | -                 | pF                     |
| Equivalent Input Noise Voltage ( $V_{CC} = 1.0\text{ V}$ , $V_{CM} = 0\text{ V}$ , $V_{EE} = \text{GND}$ ,<br>$R_S = 100\ \Omega$ )<br>$f = 1.0\text{ kHz}$   | $e_n$         | -                 | 30                | -                 | nV/ $\sqrt{\text{Hz}}$ |

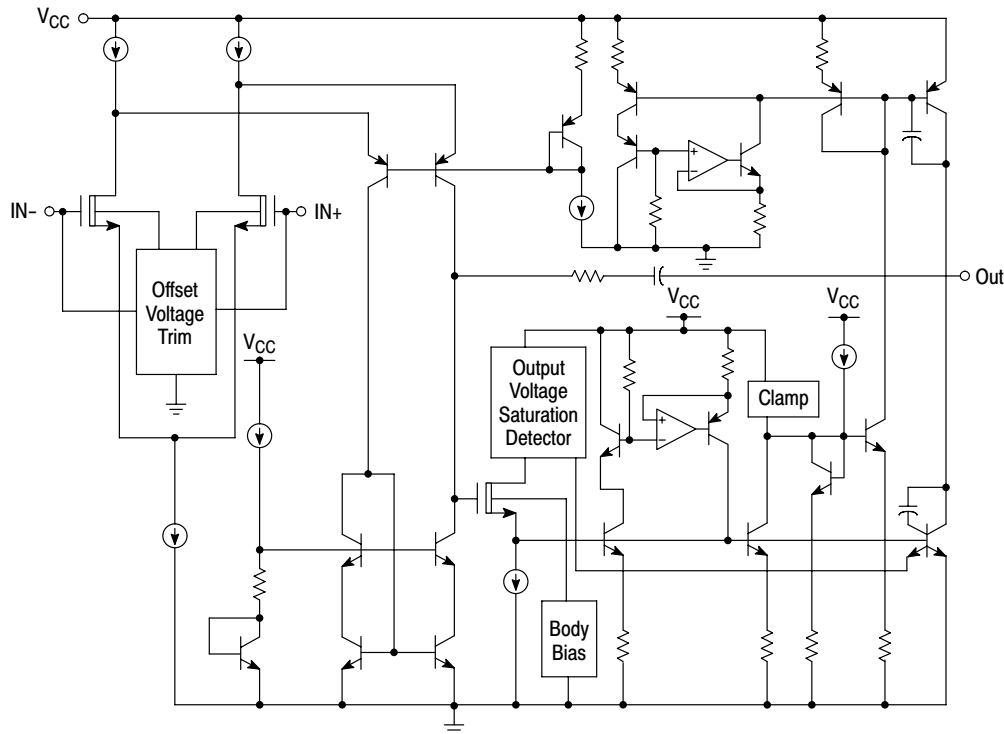

Figure 2. Representative Block Diagram

## General Information

The MC33501/503 dual operational amplifier is unique in its ability to provide 1.0 V rail-to-rail performance on both the input and output by using a SMARTMOS™ process. The amplifier output swings within 50 mV of both rails and is able to provide 50 mA of output drive current with a 5.0 V supply, and 10 mA with a 1.0 V supply. A 5.0 MHz bandwidth and a slew rate of 3.0 V/μs is achieved with high speed depletion mode NMOS (DNMOS) and vertical PNP transistors. This device is characterized over a temperature range of -40°C to 105°C.

## Circuit Information

### Input Stage

One volt rail-to-rail performance is achieved in the MC33501/503 at the input by using a single pair of depletion mode NMOS devices (DNMOS) to form a differential amplifier with a very low input current of 40 fA. The normal input common mode range of a DNMOS device, with an ion implanted negative threshold, includes ground and relies on the body effect to dynamically shift the threshold to a positive value as the gates are moved from ground towards the positive supply. Because the device is manufactured in a p-well process, the body effect coefficient is sufficiently large to ensure that the input stage will remain substantially saturated when the inputs are at the positive rail. This also applies at very low supply voltages. The 1.0 V rail-to-rail input stage consists of a DNMOS differential amplifier, a folded cascode, and a low voltage balanced mirror. The low voltage cascaded balanced mirror provides high 1st stage gain and base current cancellation without sacrificing signal integrity. A common mode feedback path is also employed to enable the offset voltage to track over the input common mode voltage. The total operational amplifier quiescent current drop is 1.3 mA/amp.

### Output Stage

An additional feature of this device is an “on demand” base current cancellation amplifier. This feature provides base drive to the output power devices by making use of a buffer amplifier to perform a voltage-to-current conversion. This is done in direct proportion to the load conditions. This “on demand” feature allows these amplifiers to consume only a few micro-amps of current when the output stage is in its quiescent mode. Yet it provides high output current when required by the load. The rail-to-rail output stage current boost circuit provides 50 mA of output current with a 5.0 V supply (For a 1.0 V supply output stage will do 10 mA) enabling the operational amplifier to drive a 600 Ω load. A buffer is necessary to isolate the load current effects in the output stage from the input stage. Because of the low voltage conditions, a DNMOS follower is used to provide an essentially zero voltage level shift. This buffer isolates any load current changes on the output stage from loading the input stage. A high speed vertical PNP transistor provides excellent frequency performance while sourcing current. The operational amplifier is also internally compensated to provide a phase margin of 60 degrees. It has a unity gain of 5.0 MHz with a 5.0 V supply and 4.0 MHz with a 1.0 V supply.

### Low Voltage Operation

The MC33501/503 will operate at supply voltages from 0.9 to 7.0 V and ground. When using the MC33501/503 at supply voltages of less than 1.2 V, input offset voltage may increase slightly as the input signal swings within approximately 50 mV of the positive supply rail. This effect occurs only for supply voltages below 1.2 V, due to the input depletion mode MOSFETs starting to transition between the saturated to linear region, and should be considered when designing high side dc sensing applications operating at the positive supply rail. Since the device is rail-to-rail on both input and output, high dynamic range single battery cell applications are now possible.

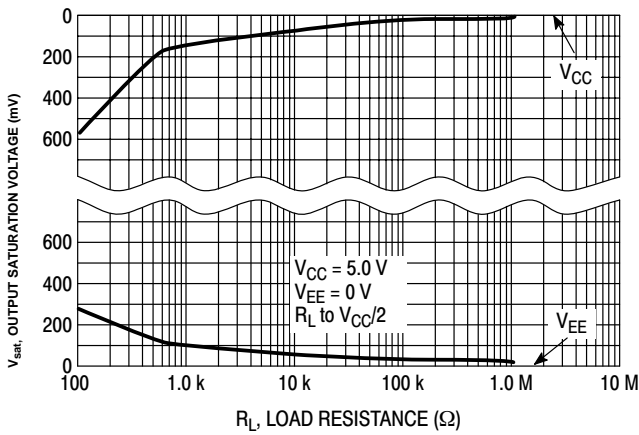

Figure 3. Output Saturation versus Load Resistance

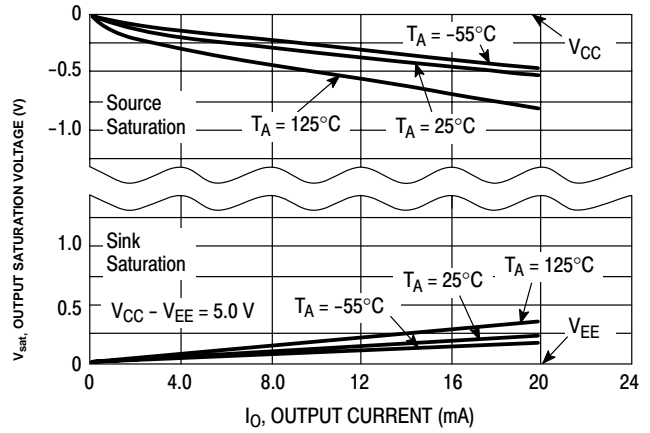

Figure 4. Drive Output Source/Sink Saturation Voltage versus Load Current

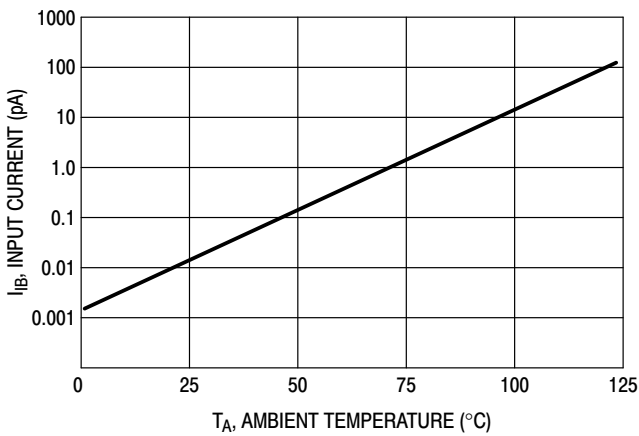

Figure 5. Input Current versus Temperature

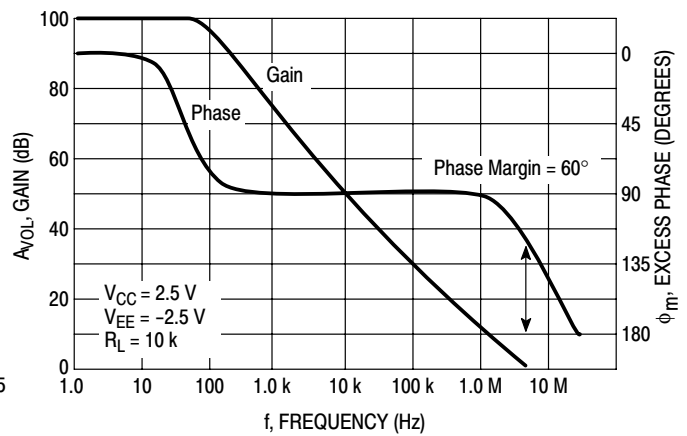

Figure 6. Gain and Phase versus Frequency

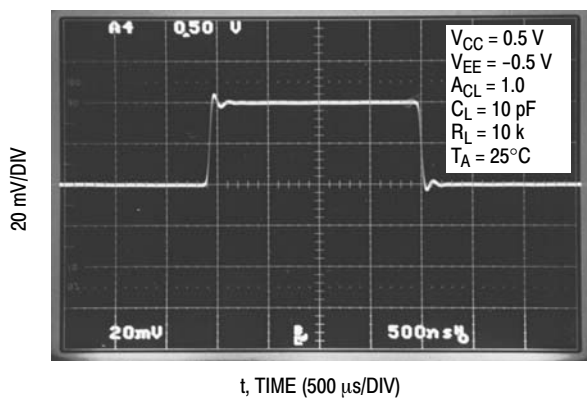

Figure 7. Transient Response

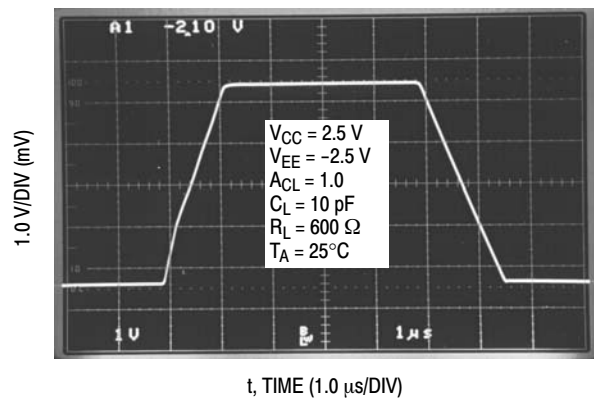
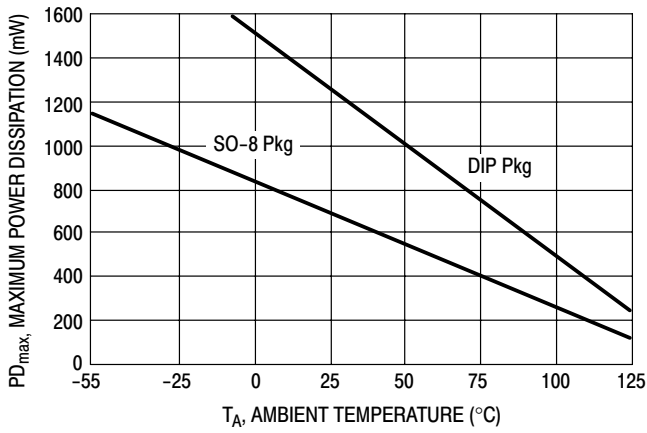
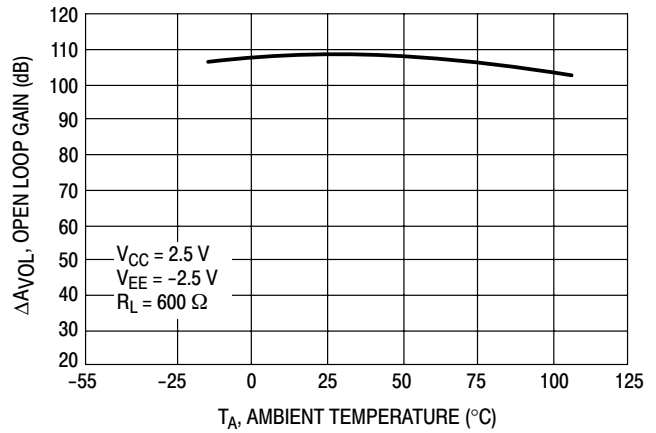

Figure 8. Slew Rate

# MC33501, MC33503



**Figure 9. Maximum Power Dissipation versus Temperature**



**Figure 10. Open Loop Voltage Gain versus Temperature**

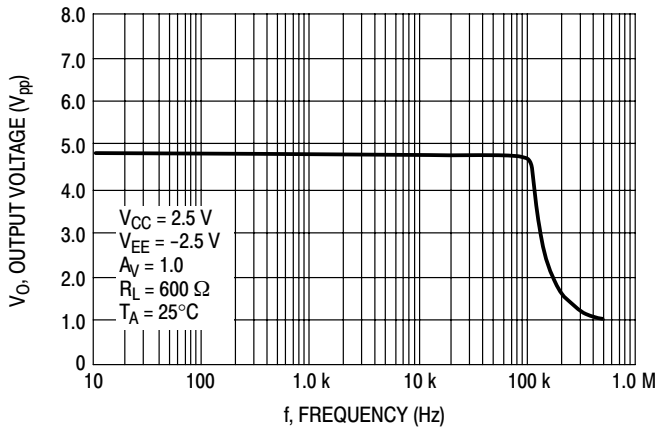

**Figure 11. Output Voltage versus Frequency**

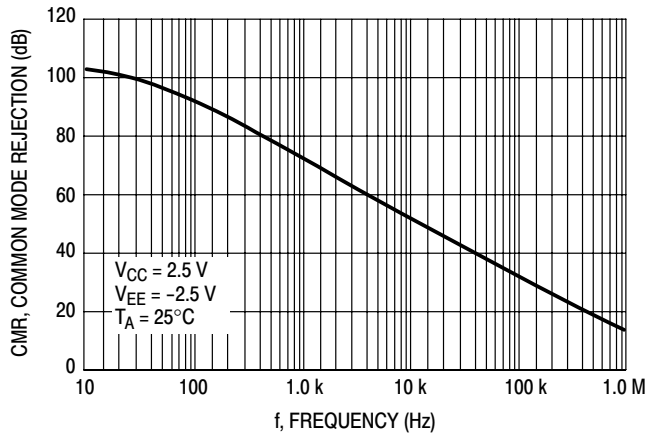

**Figure 12. Common Mode Rejection versus Frequency**

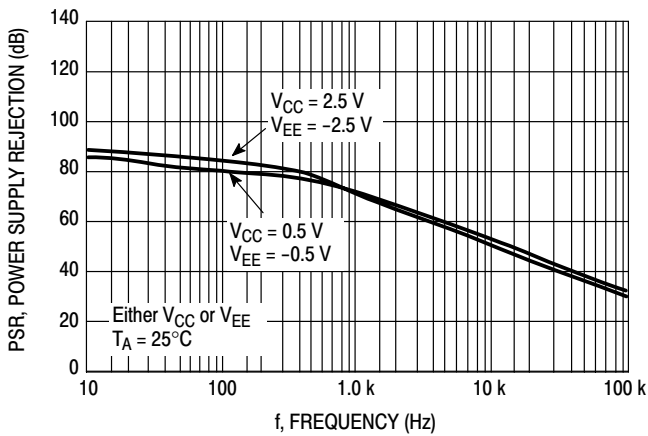

**Figure 13. Power Supply Rejection versus Frequency**

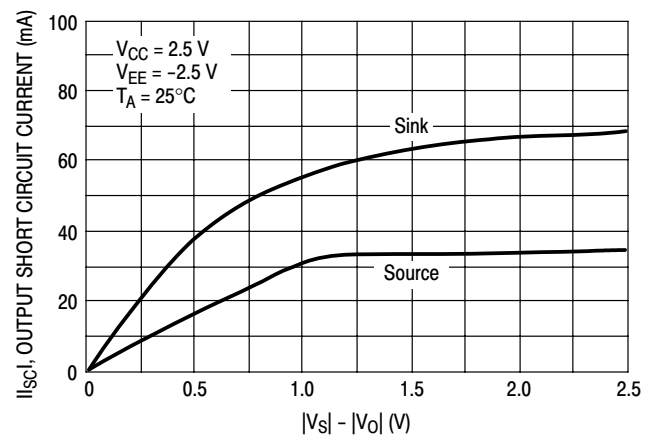

**Figure 14. Output Short Circuit Current versus Output Voltage**



# MC33501, MC33503

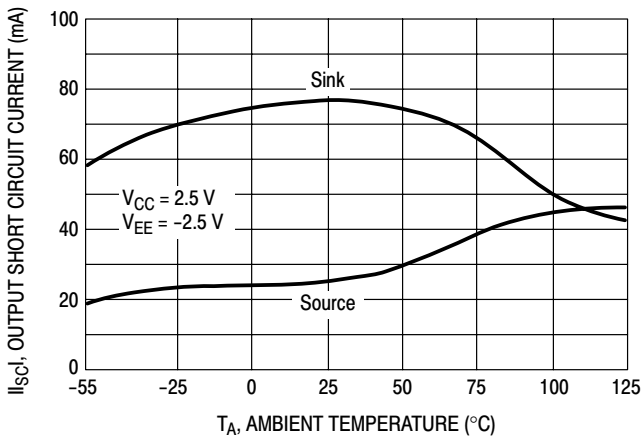

**Figure 15. Output Short Circuit Current versus Temperature**

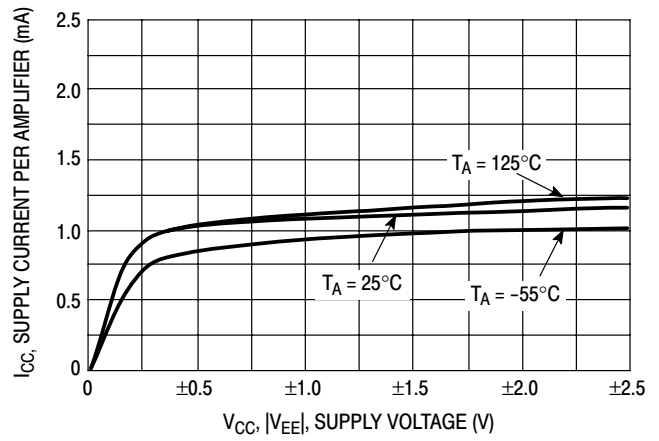

**Figure 16. Supply Current per Amplifier versus Supply Voltage with No Load**

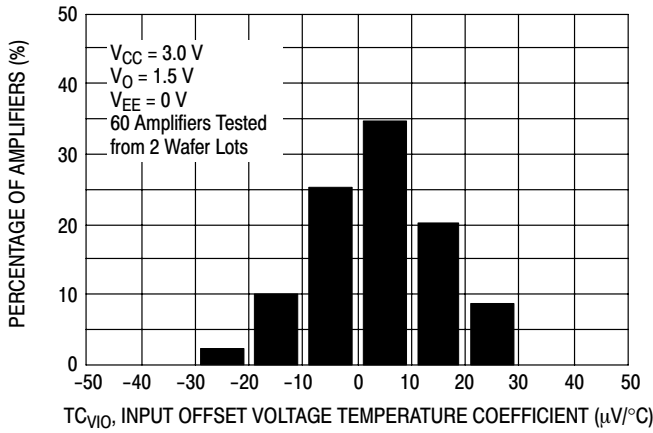

**Figure 17. Input Offset Voltage Temperature Coefficient Distribution**

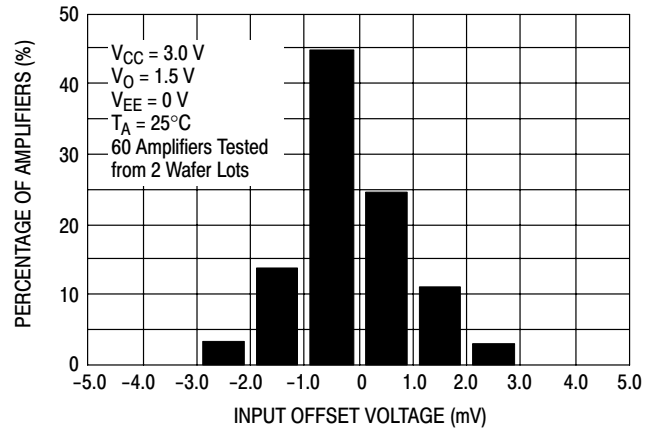

**Figure 18. Input Offset Voltage Distribution**

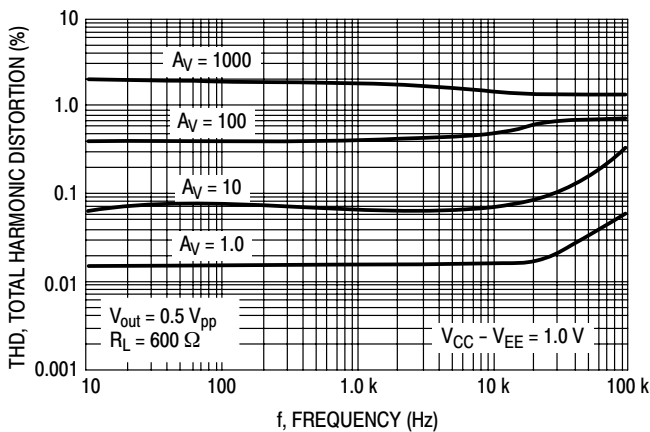

**Figure 19. Total Harmonic Distortion versus Frequency with 1.0 V Supply**

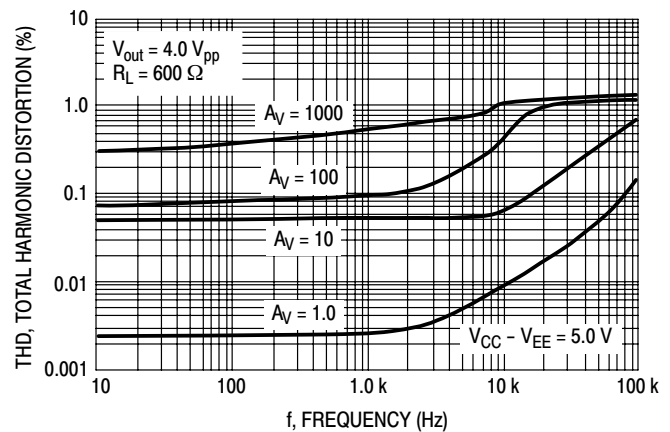

**Figure 20. Total Harmonic Distortion versus Frequency with 5.0 V Supply**

# MC33501, MC33503

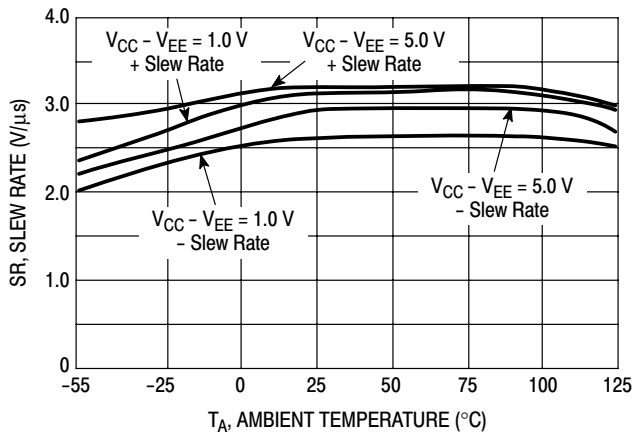

Figure 21. Slew Rate versus Temperature

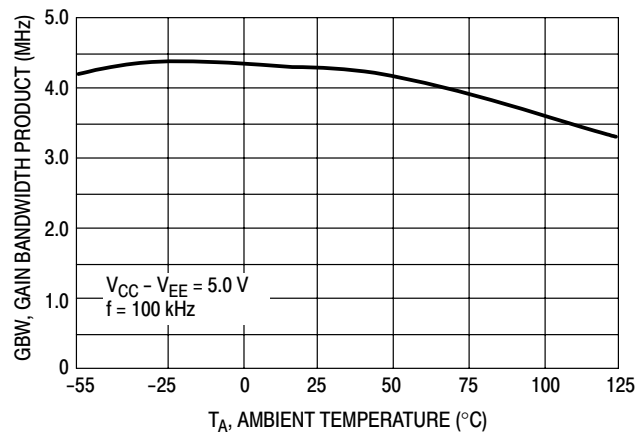

Figure 22. Gain Bandwidth Product versus Temperature

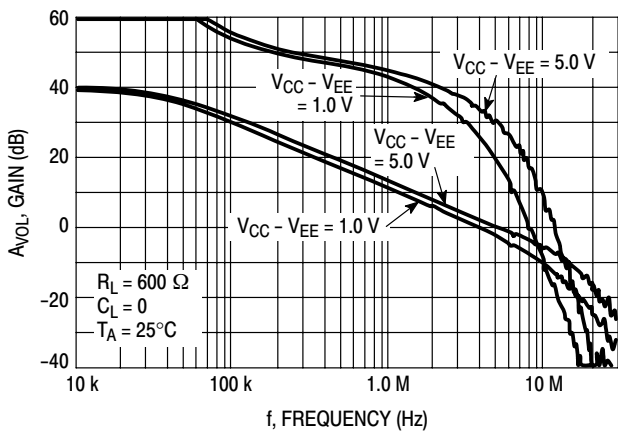

Figure 23. Voltage Gain and Phase versus Frequency

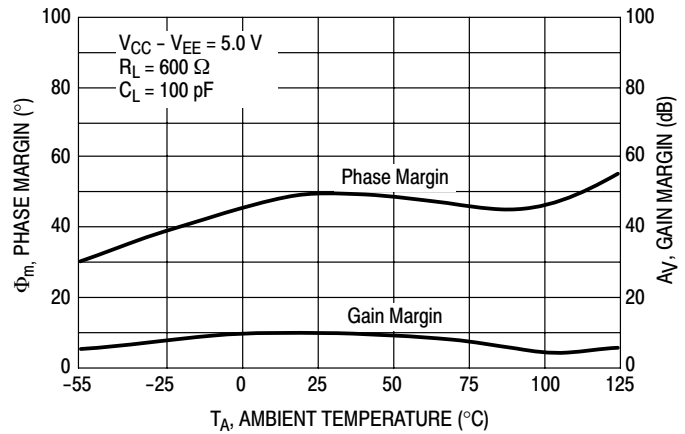

Figure 24. Gain and Phase Margin versus Temperature

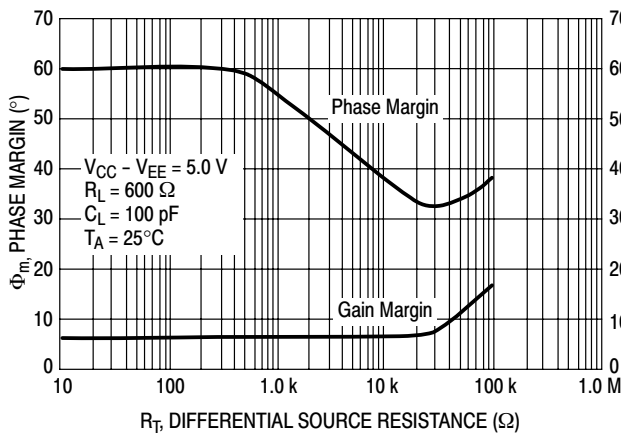

Figure 25. Gain and Phase Margin versus Differential Source Resistance

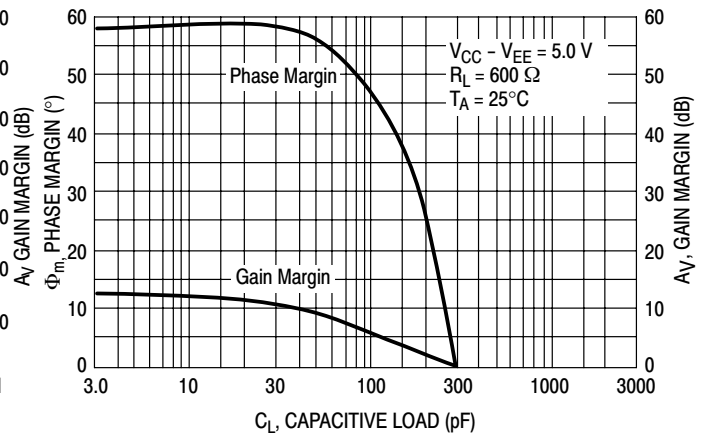
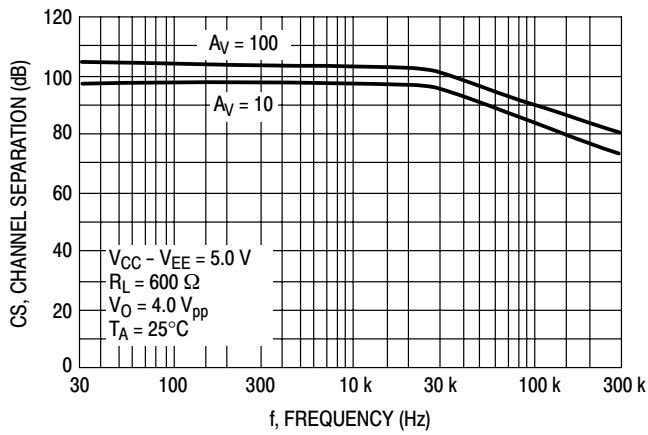
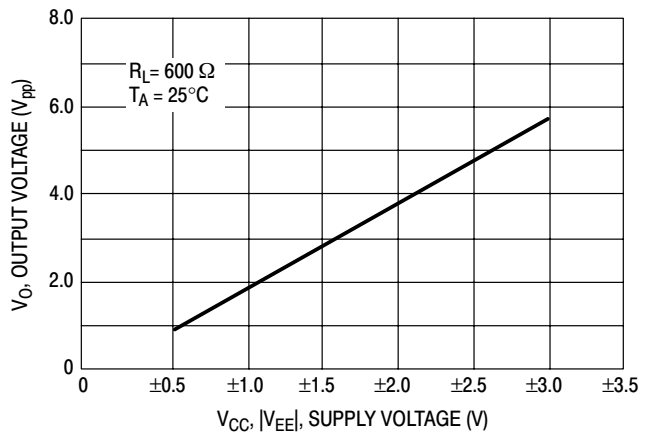

Figure 26. Feedback Loop Gain and Phase versus Capacitive Load

# MC33501, MC33503



**Figure 27. Channel Separation versus Frequency**



**Figure 28. Output Voltage Swing versus Supply Voltage**

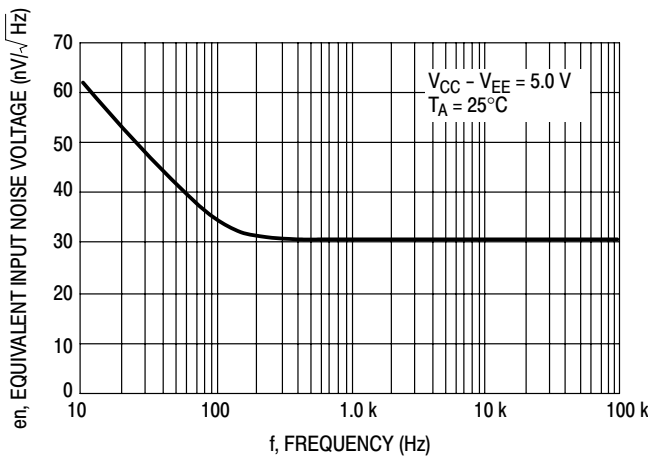

**Figure 29. Equivalent Input Noise Voltage versus Frequency**

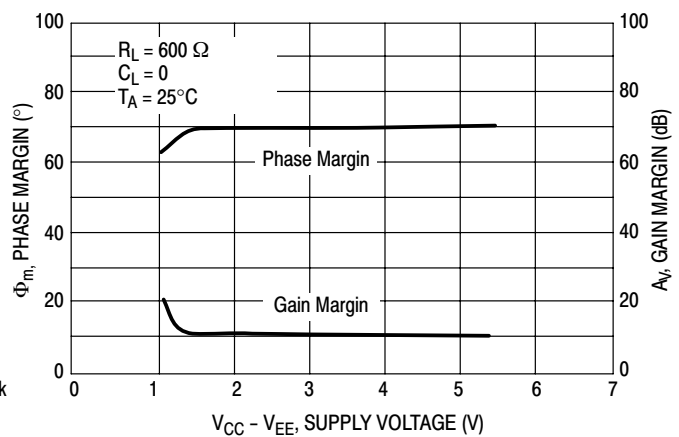

**Figure 30. Gain and Phase Margin versus Supply Voltage**

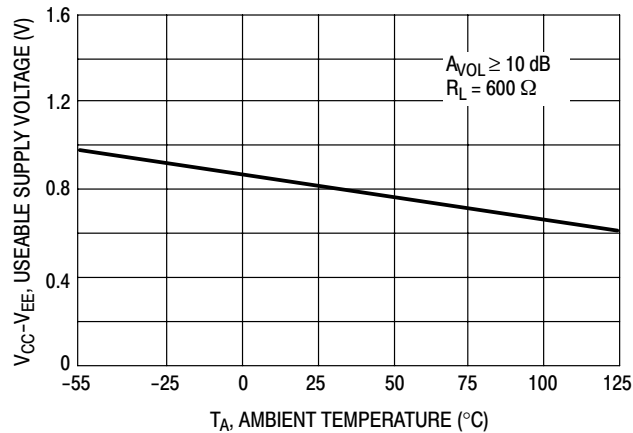

**Figure 31. Useable Supply Voltage versus Temperature**

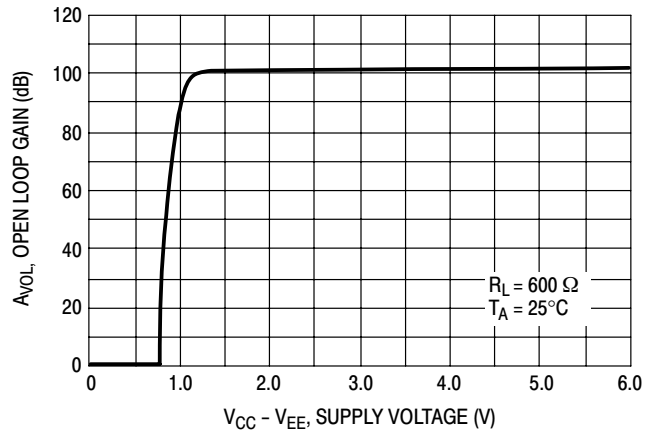

**Figure 32. Open Loop Gain versus Supply Voltage**

# MC33501, MC33503

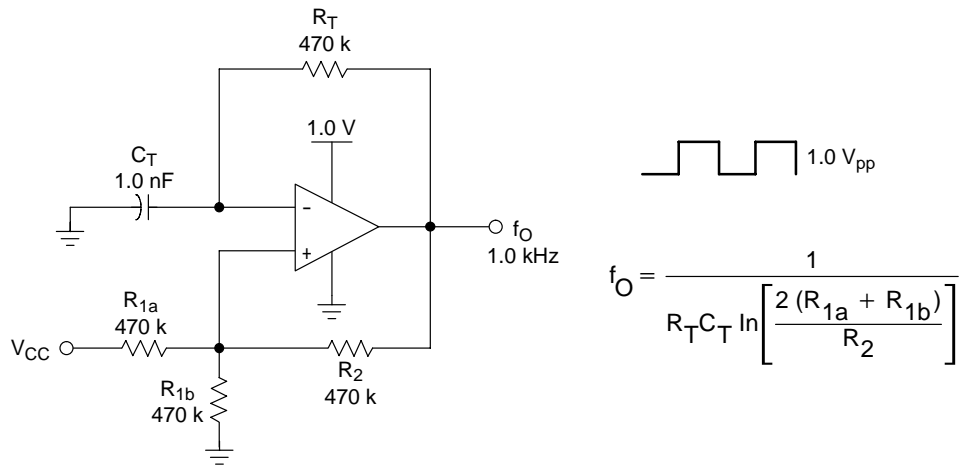
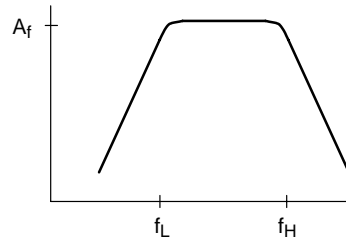
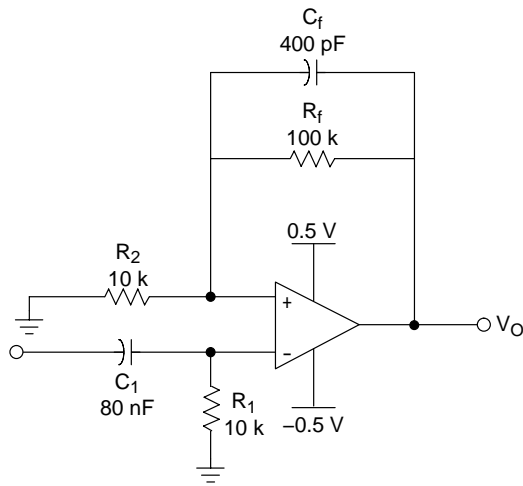

Figure 33. 1.0 V Oscillator



$$f_L = \frac{1}{2\pi R_1 C_1} \approx 200 \text{ Hz}$$

$$f_H = \frac{1}{2\pi R_f C_f} \approx 4.0 \text{ kHz}$$

$$A_f = 1 + \frac{R_f}{R_2} = 11$$

Figure 34. 1.0 V Voiceband Filter

# MC33501, MC33503

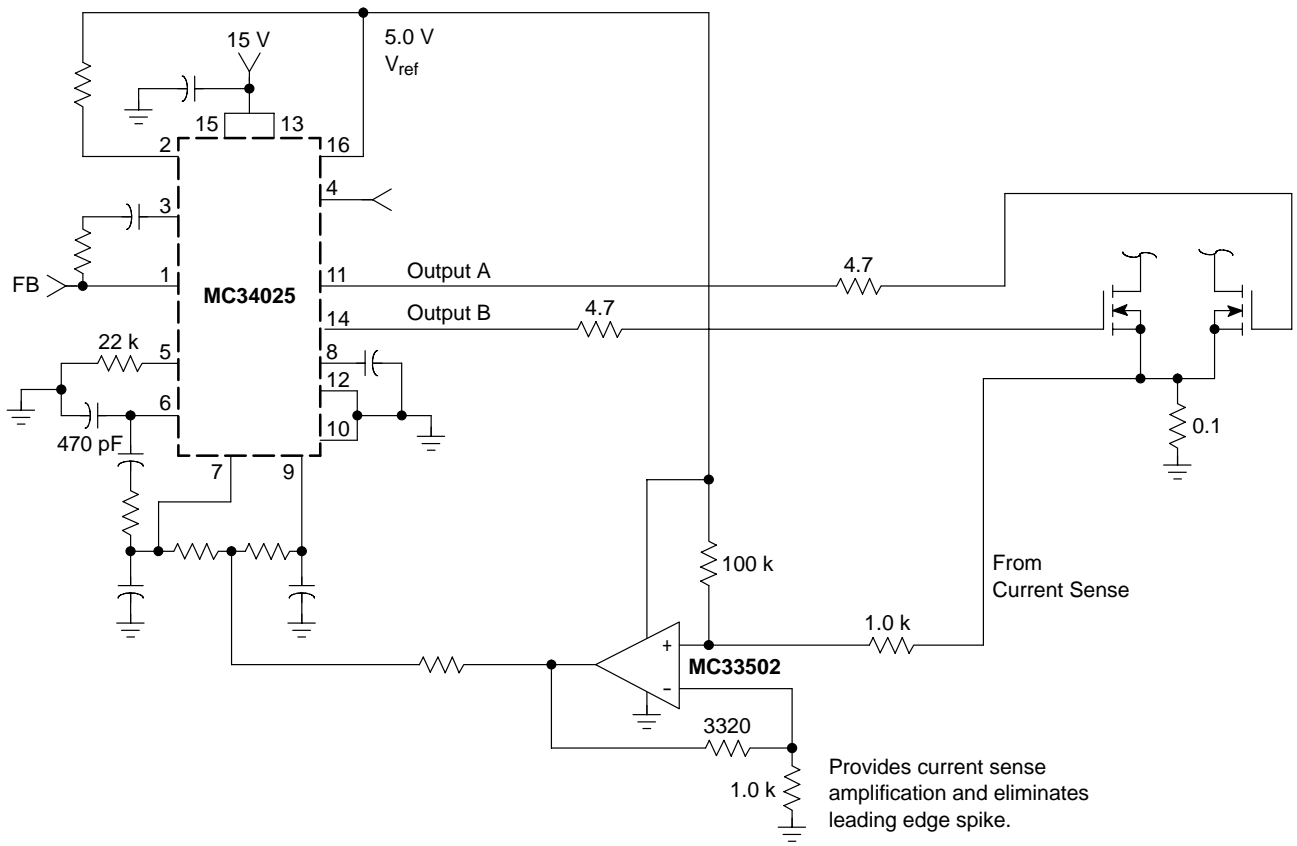
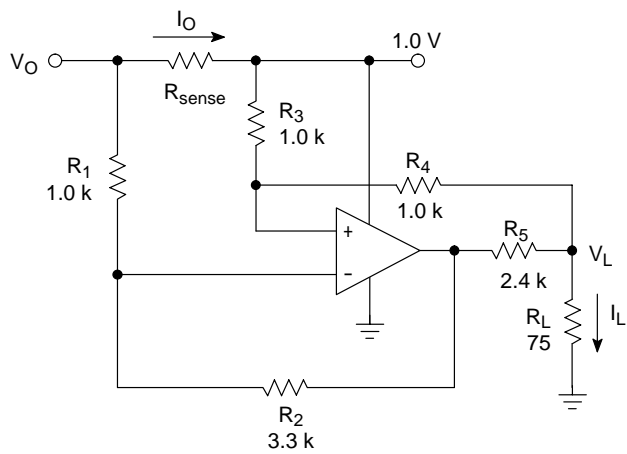

Figure 35. Power Supply Application



| $I_o$  | $I_L$       | $\Delta I_o / \Delta I_L$ |
|--------|-------------|---------------------------|
| 435 mA | 463 $\mu$ A | $-120 \times 10^{-6}$     |
| 212 mA | 492 $\mu$ A |                           |

For best performance, use low tolerance resistors.

Figure 36. 1.0 V Current Pump

# MC33501, MC33503

## PACKAGE DIMENSIONS

SOT23-5  
(TSOP-5, SC59-5)  
SN SUFFIX  
CASE 483-02  
ISSUE E

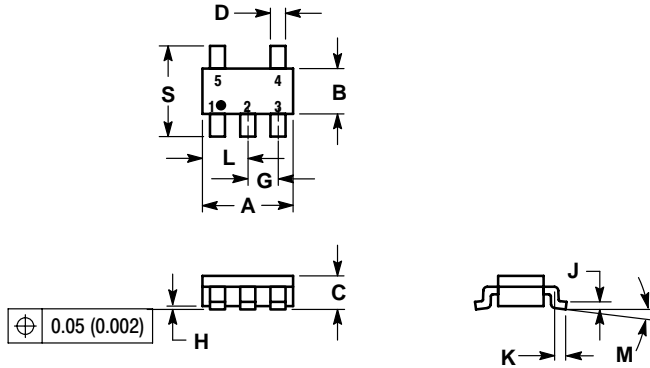

### NOTES:

1. DIMENSIONING AND TOLERANCING PER ANSI Y14.5M, 1982.
2. CONTROLLING DIMENSION: MILLIMETER.
3. MAXIMUM LEAD THICKNESS INCLUDES LEAD FINISH THICKNESS. MINIMUM LEAD THICKNESS IS THE MINIMUM THICKNESS OF BASE MATERIAL.
4. A AND B DIMENSIONS DO NOT INCLUDE MOLD FLASH, PROTRUSIONS, OR GATE BURRS.

| DIM | MILLIMETERS |       | INCHES |        |
|-----|-------------|-------|--------|--------|
|     | MIN         | MAX   | MIN    | MAX    |
| A   | 2.90        | 3.10  | 0.1142 | 0.1220 |
| B   | 1.30        | 1.70  | 0.0512 | 0.0669 |
| C   | 0.90        | 1.10  | 0.0354 | 0.0433 |
| D   | 0.25        | 0.50  | 0.0098 | 0.0197 |
| G   | 0.85        | 1.05  | 0.0335 | 0.0413 |
| H   | 0.013       | 0.100 | 0.0005 | 0.0040 |
| J   | 0.10        | 0.26  | 0.0040 | 0.0102 |
| K   | 0.20        | 0.60  | 0.0079 | 0.0236 |
| L   | 1.25        | 1.55  | 0.0493 | 0.0610 |
| M   | 0°          | 10°   | 0°     | 10°    |
| S   | 2.50        | 3.00  | 0.0985 | 0.1181 |

### SOLDERING FOOTPRINT\*

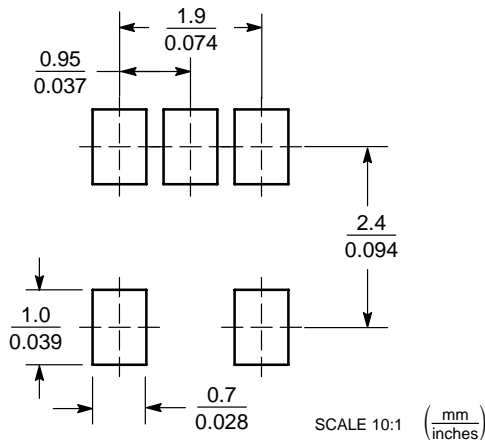

\*For additional information on our Pb-Free strategy and soldering details, please download the ON Semiconductor Soldering and Mounting Techniques Reference Manual, SOLDERRM/D.

SMARTMOS is a trademark of Motorola, Inc.

ON Semiconductor and are registered trademarks of Semiconductor Components Industries, LLC (SCILLC). SCILLC reserves the right to make changes without further notice to any products herein. SCILLC makes no warranty, representation or guarantee regarding the suitability of its products for any particular purpose, nor does SCILLC assume any liability arising out of the application or use of any product or circuit, and specifically disclaims any and all liability, including without limitation special, consequential or incidental damages. "Typical" parameters which may be provided in SCILLC data sheets and/or specifications can and do vary in different applications and actual performance may vary over time. All operating parameters, including "Typicals" must be validated for each customer application by customer's technical experts. SCILLC does not convey any license under its patent rights nor the rights of others. SCILLC products are not designed, intended, or authorized for use as components in systems intended for surgical implant into the body, or other applications intended to support or sustain life, or for any other application in which the failure of the SCILLC product could create a situation where personal injury or death may occur. Should Buyer purchase or use SCILLC products for any such unintended or unauthorized application, Buyer shall indemnify and hold SCILLC and its officers, employees, subsidiaries, affiliates, and distributors harmless against all claims, costs, damages, and expenses, and reasonable attorney fees arising out of, directly or indirectly, any claim of personal injury or death associated with such unintended or unauthorized use, even if such claim alleges that SCILLC was negligent regarding the design or manufacture of the part. SCILLC is an Equal Opportunity/Affirmative Action Employer. This literature is subject to all applicable copyright laws and is not for resale in any manner.

### PUBLICATION ORDERING INFORMATION

**LITERATURE FULFILLMENT:**  
Literature Distribution Center for ON Semiconductor  
P.O. Box 5163, Denver, Colorado 80217 USA  
**Phone:** 303-675-2175 or 800-344-3860 Toll Free USA/Canada  
**Fax:** 303-675-2176 or 800-344-3867 Toll Free USA/Canada  
**Email:** orderlit@onsemi.com

**N. American Technical Support:** 800-282-9855 Toll Free  
USA/Canada  
**Europe, Middle East and Africa Technical Support:**  
Phone: 421 33 790 2910  
**Japan Customer Focus Center**  
Phone: 81-3-5773-3850

**ON Semiconductor Website:** [www.onsemi.com](http://www.onsemi.com)

**Order Literature:** <http://www.onsemi.com/orderlit>

For additional information, please contact your local Sales Representative

MC33501/D