

MC33283

Versatile 6 Regulator Power Management Circuit for Cellular Subscriber Terminal

The MC33283 is a complete power management solution for portable devices such as telephone handsets, two-way radios, etc. Thanks to its large scale integration, the device offers up to seven Low DropOut regulators (LDO), two of them delivering a voltage higher than the battery's.

Despite the presence of an internal charge pump, the overall noise specification makes the circuit an ideal candidate where noise is an important feature. Outputs deliver 40mVRMS typical (10–100kHz) at nominal output current.

With a 50dB ripple rejection under 10kHz, the circuit naturally shields the downstream electronics against DC choppy lines. This parameter guarantees a clean operation for battery operated devices.

Finally, housed in a compact Thin Quad Flat Pack TQFP–32 package, the MC33283 gathers all the features necessary to power future portable radios.

Features:

- 6 regulated outputs:
2.85V, four outputs: 10–135mA
4.75V @ 15mA
5.0V @ 20mA
- Low-noise: 40 μ VRMS at nominal output levels (10Hz–100kHz)
- Ultra-low reverse current in OFF mode (200nA typical)
- Two-mode regulator: output 5 switches from 3 to 5V with SEL pin activated
- Thermal shutdown for a rugged and reliable operation
- All outputs are short-circuit proof

Applications:

- All Portable radios (GSM etc.)
- Bursting systems (TDMA etc.)
- Battery operated devices



ON Semiconductor®

<http://onsemi.com>

**POWER MANAGEMENT
CIRCUIT FOR
PORTABLE DEVICES
SILICON MONOLITHIC
INTEGRATED CIRCUIT**

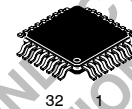

**FTB SUFFIX
PLASTIC PACKAGE
CASE 873B-02
(TQFP-32)**

PIN CONNECTIONS

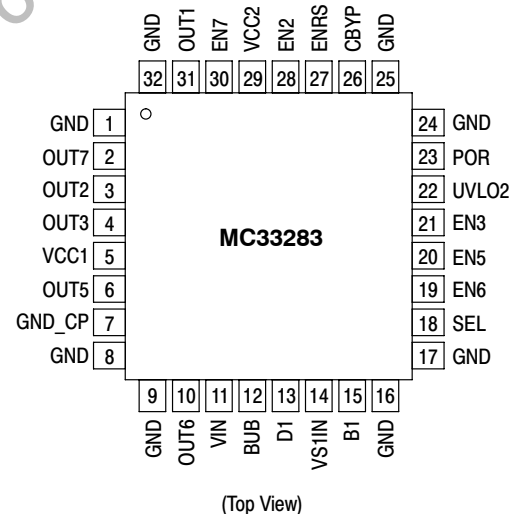

ORDERING INFORMATION

Device	Temperature Range	Package
MC33283FTB28,R2	-20°C to +70°C	TQFP32

MC33283

Simplified Block Diagram

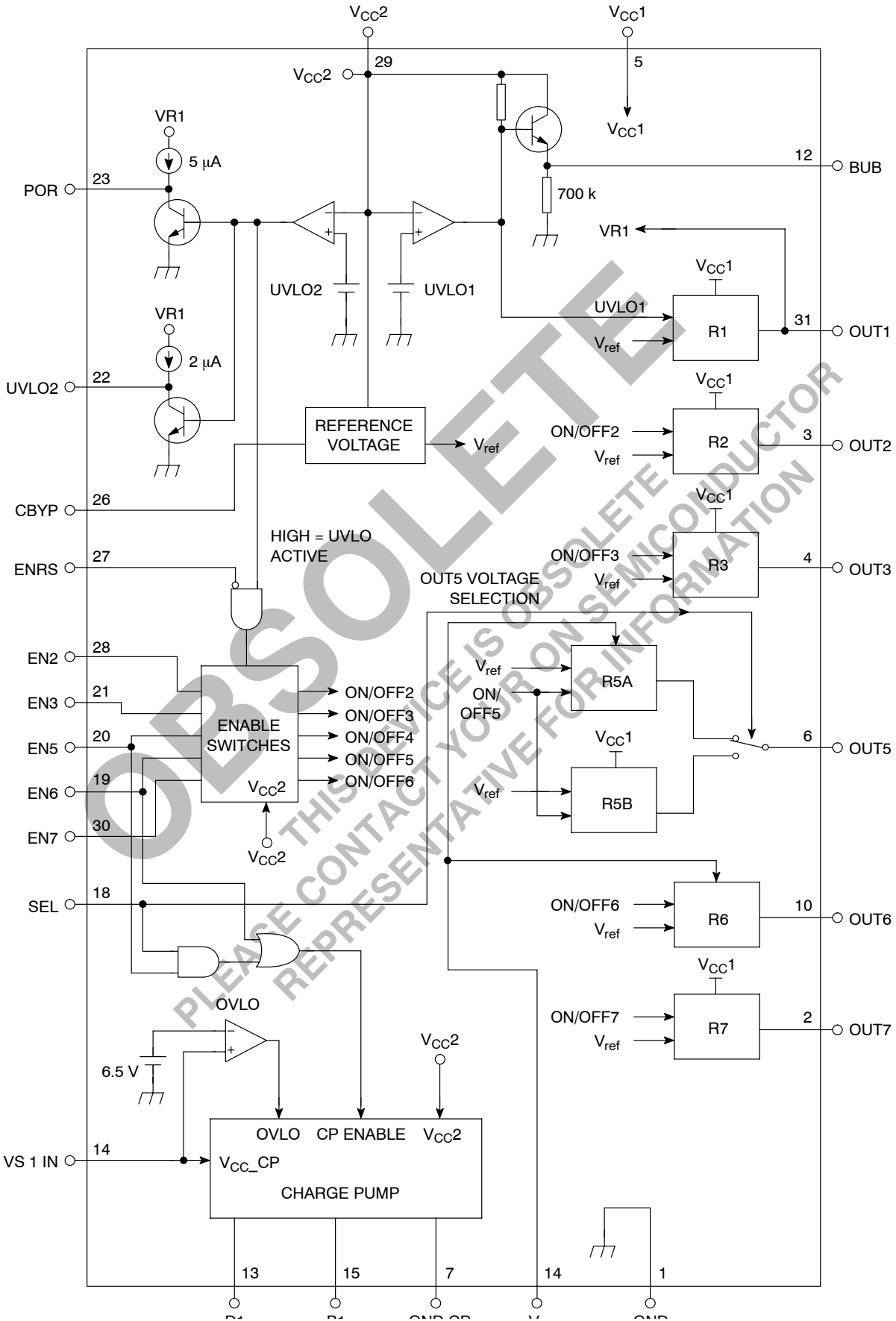

MC33283

PIN FUNCTION DESCRIPTIONS

Pin #	Pin Name	Input Output	Function	Description
1	GND	I	Grounds the IC	
2	OUT7	O	Output 7 regulator	Output 7 delivers up to 50mA
3	OUT2	O	Output 2 regulator	Output 2 delivers up to 120mA
4	OUT3	O	Output 3 regulator	Output 3 delivers up to 135mA
5	VCC1	I	IC supply voltage	This pin supplies the 2.85/3V LDOs
6	OUT5	O	Output 5 regulator	Output 5 delivers either 2.85V or 4.75V, depending on the level applied on pin 18
7	GND_CP	I	Charge pump ground	This pin requires proper grounding to keep switching noise at the lowest level
8	GND	I	Grounds the IC	
9	GND	I	Grounds the IC	
10	OUT6	O	Output 6 regulator	Output 6 delivers up to 20mA
11	VIN	I	Supplies the 5V reg.	This pin injects the charge-pump output to feed the 5V LDOs
12	BUB	O	Backup battery buffer output	This pin is able to drive an external transistor to active a backup battery
13	D1	O	Charge Pump output	D1 delivers a square-wave from the Charge Pump output
14	VS1IN	I	Charge Pump V _{CC}	Supplies the charge pump separately
15	B1	I	Boost voltage	Part of the charge pump wiring diagram
16	GND	I	Grounds the IC	
17	GND	I	Grounds the IC	
18	SEL	I	Toggles Out 5	The pin activates Out 5 either as a 4.75V or a 2.85V
19	EN6	I	Activates Out 6	Switches ON or OFF Out 6
20	EN5	I	Activates Out 5	Switches ON or OFF Out 5
21	EN3	I	Activates Out 3	Switches ON or OFF Out 3
22	UVLO2	O	Under voltage detection	Delivers a level low to warn of a low battery condition
23	POR	O	Reset signal	Goes high during the Power-on sequence
24	GND	I	Grounds the IC	
25	GND	I	Grounds the IC	
26	CBYP	I	Bypass Capacitor	Bypasses the internal bandgap
27	ENRS	I	Reset Enable	A logic high prevents Out 2, 3, 5, 6 and 7 from being switched off by UVLO2
28	EN2	I	Activates Out 2	Switches ON or OFF Out 2
29	VCC2	I	IC supply voltage	Should be connected to pin 5 for normal use
30	EN7	I	Activates Out 7	Switches ON or OFF Out 7
31	OUT1	O	Output 1 regulator	Output 6 delivers up to 50mA
32	GND	I	Grounds the IC	

MC33283

MAXIMUM RATINGS

Rating	Pin #	Symbol	Min	Max	Unit
Supply Voltage (@ battery pins)	5-29	V_{in}	-0.3	13	V
Logic Input Voltage		V_{logic}	-0.3	V_{in}	V
Logic Output Current		I_{logic}	Internally limited		A
Peak Output Current (each regulator)		I_{peak}	Internally limited		A
Thermal Resistance Junction-to-Air		$R_{\theta JA}$	80° typical		°C/W
Operating Ambient Temperature		T_A	-20	+70	°C
Maximum Operating Junction Temperature		T_J		150	°C
Storage Temperature Range		T_{stg}	-30	+85	°C
Lead Temperature				230 for 10s	°C

- NOTES:** 1. Stresses beyond those listed under "absolute maximum ratings" may cause permanent damage to the device. See "Recommended operating conditions" for functional operation of the device. The device may not operate under these conditions but will not be destroyed.
 2. All voltages are with respect to GND.

RECOMMENDED OPERATING CONDITIONS

Characteristics	Pin #	Symbol	Min	Typ	Max	Unit
Supply Voltage (Vcc1)	5	Vcc1	3.13	-	6.5	V
Supply Voltage (Vcc2)	29	Vcc2	0	-	6.5	V
Supply Voltage (VS1IN)	14	VS1IN	3.13	-	6.5	V
Operating free-air temperature			-20	-	+70	°C

DEVICE MARKING

Line 1	(M)
Line 2	MC33283F
Line 3	TB28
Line 4	Date and traceability code

MC33283

REGULATOR R1

ELECTRICAL CHARACTERISTICS (For typical values $T_A = 25^\circ\text{C}$, for min/max values $T_A = -40^\circ\text{C}$ to $+85^\circ\text{C}$ / Max $T_J = 125^\circ\text{C}$ unless otherwise noted)

Characteristics	Test Conditions	Min	Typ	Max	Unit	Notes
Output Voltage	$3.13\text{V} < V_{cc1} < 6.5\text{V}$	2.70	2.85	3.00	V	Limits apply over all normal operating conditions, except load transient response
Line Regulation	$1\text{Vpp} @ I_{out} = 11\text{mA}$		1.0	10	mV	
Load Regulation	$0\text{mA} < I_{out} < 50\text{mA}$		12	25	mV	
PSRR	$1\text{V pk-pk}, I_{out} = 11\text{mA}$ $0\text{kHz} < f < 3\text{kHz}$ $3\text{kHz} < f < 8\text{kHz}$ $8\text{kHz} < f < 10\text{kHz}$	50 40 35	60 50 45		dB	EN2-EN7 disabled, V_{cc2} connected
Quiescent current (ground current)	ON, $I_{out} = 50\text{mA}$ ON, $I_{out} = 50\mu\text{A}$		2.0 270	3.0 330	mA μA	
Short circuit current		75	100		mA	
Reverse output current	$V_{backup} = 2.85\text{V}$		0.2	5.0	μA	R1 disabled
Integrated RMS Noise	$10\text{Hz} - 100\text{kHz}, I_{out} = 11\text{mA}$		40		μV	
Settling time	$3.0\text{V} > V_{out} > 2.7\text{V}, I_{out} = 50\text{mA}$		0.1		ms	V_{cc} (1&2) 0 to 3.13V (battery connected)

The regulator must function normally under the following conditions:

Load current		0		50	mA	
Output capacitor		0.8	1.0		μF	Ceramic
Capacitor ESR		0.01	0.1	1.0	Ω	

MC33283

REGULATOR R2

ELECTRICAL CHARACTERISTICS (For typical values $T_A = 25^\circ\text{C}$, for min/max values $T_A = -40^\circ\text{C}$ to $+85^\circ\text{C}$ / Max $T_J = 125^\circ\text{C}$ unless otherwise noted)

Characteristics	Test Conditions	Min	Typ	Max	Unit	Notes
Output Voltage	$3.13\text{V} < V_{cc1} < 6.5\text{V}$	2.70	2.85	3.00	V	Limits apply over all normal operating conditions, except load transient response
Line Regulation	$1\text{Vpp} @ I_{out} = 75\text{mA}$		0.5	10	mV	
Load Regulation	$0\text{mA} < I_{out} < 100\text{mA}$		3.0	12	mV	
PSRR	$1\text{V pk-pk}, I_{out} = 75\text{mA}$ $0\text{kHz} < f < 3\text{kHz}$ $3\text{kHz} < f < 8\text{kHz}$ $8\text{kHz} < f < 10\text{kHz}$	50 40 35	60 50 45		dB	EN2-EN7 disabled, V_{cc2} connected
Quiescent current (ground current)	ON, $I_{out} = 120\text{mA}$ ON, $I_{out} = 100\mu\text{A}$		4.5 70	6.5 120	mA μA	
Short circuit current		180	250		mA	
Integrated RMS Noise	$10\text{Hz} - 100\text{kHz}, I_{out} = 75\text{mA}$		40		μV	
Settling time	$3.0\text{V} > V_{out} > 2.7\text{V}, I_{out} = 120\text{mA}$		0.1		ms	$V_{on/off}$ 0 to 2.4V (regulated enabled)

The regulator must function normally under the following conditions:

Load current		0		120	mA	
Output capacitor		0.8	1.0		μF	Ceramic
Capacitor ESR		0.01	0.1	1.0	Ω	

MC33283

REGULATOR R3

ELECTRICAL CHARACTERISTICS (For typical values $T_A = 25^\circ\text{C}$, for min/max values $T_A = -40^\circ\text{C}$ to $+85^\circ\text{C}$ / Max $T_J = 125^\circ\text{C}$ unless otherwise noted)

Characteristics	Test Conditions	Min	Typ	Max	Unit	Notes
Output Voltage	$3.13\text{V} < V_{cc1} < 6.5\text{V}$	2.70	2.85	3.00	V	Limits apply over all normal operating conditions, except load transient response
Line Regulation	$1\text{Vpp} @ I_{out} = 82\text{mA}$		0.3	10	mV	
Load Regulation	$0\text{mA} < I_{out} < 135\text{mA}$		3.0	13.5	mV	
PSRR	$1\text{V pk-pk}, I_{out} = 11\text{mA}$ $0\text{kHz} < f < 3\text{kHz}$ $3\text{kHz} < f < 8\text{kHz}$ $8\text{kHz} < f < 10\text{kHz}$	50 40 35	60 50 45		dB	EN2-EN7 disabled, V_{cc2} connected
Quiescent current (ground current)	ON, $I_{out} = 50\text{mA}$ ON, $I_{out} = 10\mu\text{A}$		4.5 70	6.5 120	mA μA	
Short circuit current		203	270		mA	
Integrated RMS Noise	$10\text{Hz} - 100\text{kHz}, I_{out} = 79\text{mA}$		40		μV	
Settling time	$3.0\text{V} > V_{out} > 2.7\text{V}, I_{out} = 135\text{mA}$		0.1		ms	$V_{on/off}$ 0 to 2.4V (regulator enabled)

The regulator must function normally under the following conditions:

Load current		0		135	mA	
Output capacitor		0.8	1.0		μF	Ceramic
Capacitor ESR		0.01	0.1	1.0	Ω	

MC33283

REGULATOR R5 (R5A, "5V")

ELECTRICAL CHARACTERISTICS (For typical values $T_A = 25^\circ\text{C}$, for min/max values $T_A = -40^\circ\text{C}$ to $+85^\circ\text{C}$ / Max $T_J = 125^\circ\text{C}$ unless otherwise noted)

Characteristics	Test Conditions	Min	Typ	Max	Unit	Notes
Output Voltage	Recommended operating conditions SEL = HIGH	4.5	4.75	5.0	V	Limits apply over all normal operating conditions, except load transient response
Line Regulation	1Vpp input on VS1IN at 6mA output		0.3	20	mV	
Load Regulation	0mA < Iout < 15mA		3.0	7.5	mV	
PSRR	1V pk-pk, Iout = 11mA 0kHz < f < 3kHz 3kHz < f < 8kHz 8kHz < f < 10kHz	50 40 35	60 50 45		dB	EN2-EN7 disabled, Vcc2 connected
Quiescent current (ground current)	ON, Iout = 10mA ON, Iout = 100μA		1.2 120	2.0 160	mA μA	Include R5b output divider
Short circuit current		22.5	30		mA	
Integrated RMS Noise	10Hz - 100kHz, Iout = 6mA		40		μV	
Settling time	5.0V > Vout > 4.5V		0.1		ms	Von/off 0 to 2.4V (regulator enabled)
	Iout = 15mA		0.5		ms	Charge pump not running when Reg. enabled

The regulator must function normally under the following conditions:

Load current	SEL = HIGH	0		15	mA	
Output capacitor		0.8	1.0		μF	Ceramic
Capacitor ESR		0.01	0.1	1.0	Ω	

MC33283

REGULATOR R5 (R5B, "3V")

ELECTRICAL CHARACTERISTICS (For typical values $T_A = 25^\circ\text{C}$, for min/max values $T_A = -40^\circ\text{C}$ to $+85^\circ\text{C}$ / Max $T_J = 125^\circ\text{C}$ unless otherwise noted)

Characteristics	Test Conditions	Min	Typ	Max	Unit	Notes
Output Voltage	$3.13\text{V} < V_{CC} < 6.5\text{V}$ SEL = LOW	2.70	2.85	3.00	V	Limits apply over all normal operating conditions, except load transient response
Line Regulation	$1\text{Vpp} @ I_{out} = 3\text{mA}$		0.3	10	mV	
Load Regulation	$0\text{mA} < I_{out} < 10\text{mA}$		2.0	7.5	mV	
PSRR	$1\text{V pk-pk}, I_{out} = 3\text{mA}$ $0\text{kHz} < f < 3\text{kHz}$ $3\text{kHz} < f < 8\text{kHz}$ $8\text{kHz} < f < 10\text{kHz}$	50 40 35	60 50 45		dB	
Quiescent current (ground current)	ON, $I_{out} = 15\text{mA}$ ON, $I_{out} = 100\mu\text{A}$		1.2 80	2.0 120	mA μA	
Short circuit current		22.5	30		mA	
Integrated RMS Noise	$10\text{Hz} - 100\text{kHz}, I_{out} = 6\text{mA}$		25		μV	
Settling time	$3.0\text{V} > V_{out} > 2.7\text{V}$		0.1		ms	$V_{on/off}$ 0 to 2.4V (regulator enabled)

The regulator must function normally under the following conditions:

Load current	SEL = LOW	0		10	mA	
Output capacitor		0.8	1.0		μF	Ceramic
Capacitor ESR		0.01	0.1	1.0	Ω	

MC33283

REGULATOR R6

ELECTRICAL CHARACTERISTICS (For typical values $T_A = 25^\circ\text{C}$, for min/max values $T_A = -40^\circ\text{C}$ to $+85^\circ\text{C}$ / Max $T_J = 125^\circ\text{C}$ unless otherwise noted)

Characteristics	Test Conditions	Min	Typ	Max	Unit	Notes
Output Voltage	Recommended operating conditions	4.75	4.9	5.25	V	Limits apply over all normal operating conditions, except load transient response
Line Regulation	1Vpp input on VS1IN at 6mA output		0.3	4.0	mV	
Load Regulation	0mA < Iout < 20mA		2.0	6.0	mV	
PSRR	1V pk-pk, Iout = 11mA 0kHz < f < 3kHz 3kHz < f < 8kHz 8kHz < f < 10kHz	50 40 35	60 50 45		dB	
Quiescent current (ground current)	ON, Iout = 20mA ON, Iout = 100μA		1.2 70	2.0 120	mA μA	
Short circuit current		30	40		mA	
Integrated RMS Noise	10Hz - 100kHz, Iout = 6mA		25		μV	
Settling time	4.75V > Vout > 5.25V		0.1		ms	Von/off 0 to 2.4V (regulator enabled)
	Iout = 20mA		0.5		ms	Charge pump not running when Reg. enabled

The regulator must function normally under the following conditions:

Load current		0		20	mA	
Output capacitor		0.8	1.0		μF	Ceramic
Capacitor ESR		0.01	0.1	1.0	Ω	

MC33283

REGULATOR R7

ELECTRICAL CHARACTERISTICS (For typical values $T_A = 25^\circ\text{C}$, for min/max values $T_A = -40^\circ\text{C}$ to $+85^\circ\text{C}$ / Max $T_J = 125^\circ\text{C}$ unless otherwise noted)

Characteristics	Test Conditions	Min	Typ	Max	Unit	Notes
Output Voltage	$3.13\text{V} < V_{cc1} < 6.5\text{V}$	2.70	2.85	3.00	V	Limits apply over all normal operating conditions, except load transient response
Line Regulation	$1\text{Vpp} @ I_{out} = 50\text{mA}$		0.3	10	mV	
Load Regulation	$0\text{mA} < I_{out} < 50\text{mA}$		12	25	mV	
PSRR	$1\text{V pk-pk}, I_{out} = 37\text{mA}$ $0\text{kHz} < f < 3\text{kHz}$ $3\text{kHz} < f < 8\text{kHz}$ $8\text{kHz} < f < 10\text{kHz}$	50 40 35	60 50 45		dB	
Quiescent current (ground current)	ON, $I_{out} = 50\text{mA}$ ON, $I_{out} = 100\mu\text{A}$		2.0 70	3.0 120	mA μA	
Short circuit current		75	100		mA	
Integrated RMS Noise	$10\text{Hz} - 100\text{kHz}, I_{out} = 50\text{mA}$		25		μV	
Settling time	$3.0\text{V} > V_{out} > 2.7\text{V}, I_{out} = 50\text{mA}$		0.1		ms	$V_{on/off}$ 0 to 2.4V (regulator enabled)

The regulator must function normally under the following conditions:

Load current		0		50	mA	
Output capacitor		0.8	1.0		μF	Ceramic
Capacitor ESR		0.01	0.1	1.0	Ω	

CHARGE PUMP

Characteristics	Test Conditions	Min	Typ	Max	Unit	Notes
The charge pump must function normally under the following conditions:						
Frequency		270	300	330	kHz	
Noise injected by the charge pump on the battery line	$0 < f < 220\text{kHz}$ and $350 < f < 410\text{kHz}$		20		μVrms	$Z_{in} = 300\text{m}\Omega$
Quiescent Current	On, $I_{out} = 25\text{mA}$ On, $I_{out} = 200\mu\text{A}$		1.5 1.2	2.5 2.0	mA	
Output Current				25	mA	
Source Impedance				300	$\text{m}\Omega$	Battery Z_{in}
Input Capacitor			1.0	4.7	μF	Ceramic
Output Capacitor			1.0	4.7	μF	Ceramic
Switching Capacitor				4.7	μF	Ceramic; preferred value $\leq 1\mu\text{F}$

NOTES: 1. The structure of the charge pump is a doubler.

REGULATOR ELECTRICAL CHARACTERISTICS

ELECTRICAL CHARACTERISTICS (For typical values $T_A = 25^\circ\text{C}$, for min/max values $T_A = -40^\circ\text{C}$ to $+85^\circ\text{C}$ / Max $T_J = 125^\circ\text{C}$ unless otherwise noted)

UNDERVOLTAGE LOCKOUT**Undervoltage lockout 1 (UVLO1)**

Characteristics	Test Conditions	Min	Typ	Max	Unit	Notes
Threshold Voltage	UVLO2h – UVLO1h > 100mV*	2.6	2.72	2.9	V	
Hysteresis			90		mV	

Undervoltage lockout 2 (UVLO2)

Threshold Voltage	UVLO2h – UVLO1h > 100mV*	2.85	2.95	3.1	V	
Hysteresis			100		mV	

*NOTE: Where the values of UVLO1h and UVLO2h are defined in the section "application hints".

Over temperature protection

Threshold			155		$^\circ\text{C}$	
-----------	--	--	-----	--	------------------	--

OBSOLETE

THIS DEVICE IS OBSOLETE
PLEASE CONTACT YOUR ON SEMICONDUCTOR
REPRESENTATIVE FOR INFORMATION

MC33283

DEDICATED CONTROL PINS

Characteristics	Test Conditions	Min	Typ	Max	Unit	Notes
Power ON Reset (POR) logic output						
Output Current	Range 0V to 2.2V	4.0	5.0	6.0	μA	
Output Low Voltage			0.01	0.3	V	V _{cc} < UVLO2 Threshold
Output High Voltage		2.2	2.8	Vr1*	V	V _{cc} ≥ UVLO2 Threshold + Hysteresis
Discharge Current	V _{cc} ≥ 2.75V V _{out1} > VPOR > 0.6V	10	20		μA	

*NOTE: Vr1 is the output voltage of regulator 1

Backup Battery Buffer Output (BUB) logic output

Output Low Voltage			0.01	0.7	V	V _{cc} < UVLO1 Threshold
Output High Voltage		2.0	2.3	V _{cc}	V	V _{cc} ≥ UVLO1 Threshold + Hysteresis

UVLO2 logic output (UVLO2OUT)

Output Low Voltage			0.01	0.3	V	V _{cc} < UVLO2 Threshold
Output High Voltage		2.3	2.8	Vr1*	V	V _{cc} ≥ UVLO2 Threshold + Hysteresis

*NOTE: Vr1 is the output voltage of regulator 1

ON/OFF logic inputs (EN2, EN3, EN5, EN6, EN7)

On/Off Control Voltage		1.5	1.2	0.5	V	Logic '0' = shutdown Logic '1' = enabled
On/Off Input Current	Control Voltage 2.85V		2.0 0.001	± 8.0 ≤ 1.0	μA	Enabled Shutdown

OUT5 voltage selection pin (SEL) logic input

On/Off Control Voltage		2.2	1.2	0.5	V	Logic '0' = 3V Operation Logic '1' = 5V Operation
On/Off Input Current	Control Voltage 2.85V		2.0 0.001	± 8.0 ≤ 1.0	μA	5V Operation 3V Operation

Enable Reset from UVLO2 signal (ENRS) logic input

On/Off Control Voltage		2.2	0.5	0.25	V	Logic '0' = UVLO2 disables regulators Logic '1' = UVLO2 no effect on regulators
On/Off Input Current	Control Voltage 2.85V		3.0 0.001	± 8.0 ≤ 1.0	μA	UVLO2 no effect UVLO2 disables regs.

TOTAL QUIESCENT CURRENT

Quiescent Current	V _{cc2} disconnected		1.0	20	μA	V _{cc} = 4.8V
Max. Input Current for V _{cc2}	V _{cc2} = 4.8V		240	300	μA	

STATE TABLES

Regulators

Regulators	Regulator Status	Mode
Regulator 1	Enabled	Vcc > UVLO1 threshold + hysteresis
	Disabled	Vcc < UVLO1 threshold
Regulator 2	Enabled	ON/OFF2 = logic "1"
	Disabled	ON/OFF2 = logic "0"
Regulator 3	Enabled	ON/OFF3 = logic "1"
	Disabled	ON/OFF3 = logic "0"
Regulator 6	Enabled	ON/OFF6 = logic "1"
	Disabled	ON/OFF6 = logic "0"
Regulator 7	Enabled	ON/OFF7 = logic "1"
	Disabled	ON/OFF7 = logic "0"
Regulator 5 Selection between 3V/5V		
	3V	SEL = logic low
	5V	SEL = logic high
Enabling Regulator 5	Disabled	ON/OFF5 = logic "0"
	Enabled	ON/OFF5 = logic "1"

CHARGE PUMP

Control Signal			Charge Pump Status
ON/OFF6	ON/OFF5	SEL	
0	0	X	Disabled
0	X	0	Disabled
X	1	1	Enabled
1	X	X	Enabled

TYPICAL CHARACTERIZATION CURVES

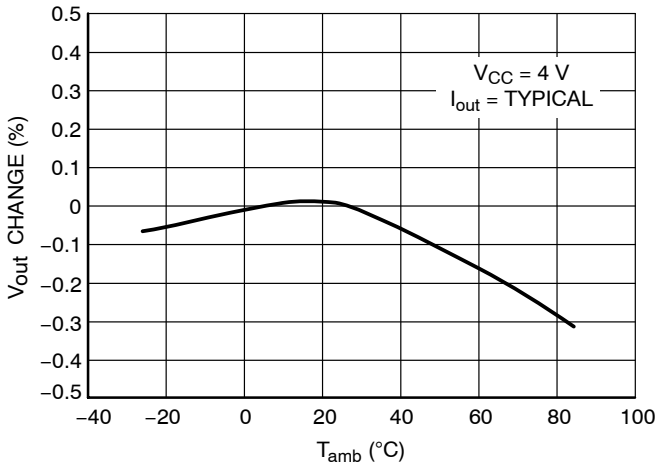

Figure 1. Normalized Output Voltage Change versus Temperature (2.85 V Regulators)

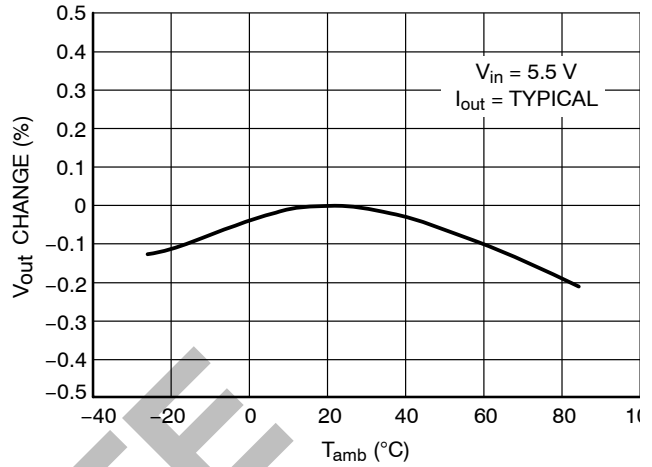

Figure 2. Normalized Output Voltage Change versus Temperature (5 V Regulators)

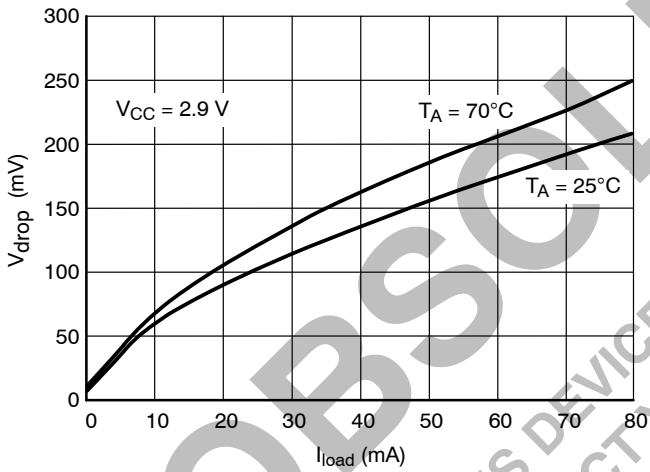

Figure 3. Dropout versus Load Current (Regulators R1, R7)

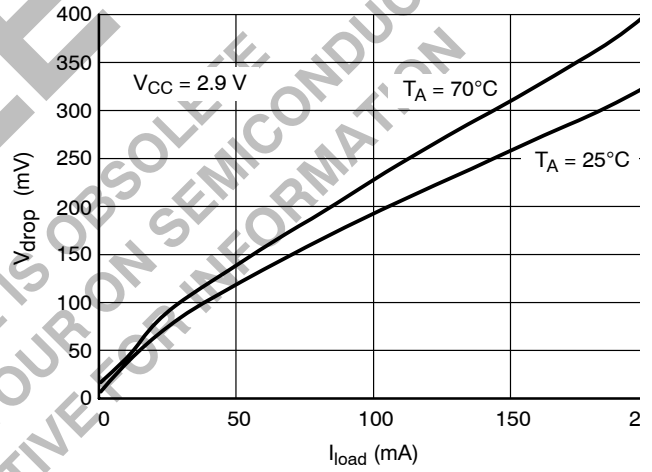

Figure 4. Dropout versus Load Current (Regulator R2)

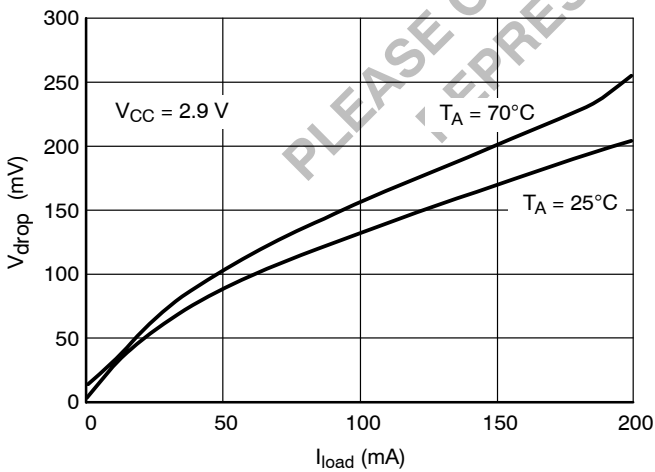

Figure 5. Dropout versus Load Current (Regulator R3)

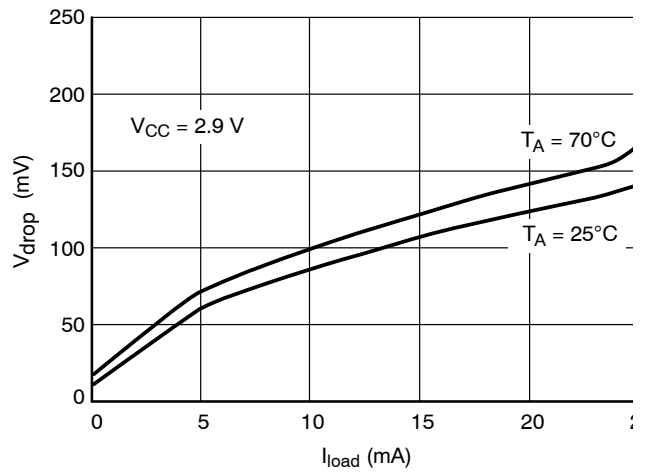

Figure 6. Dropout versus Load Current (Regulator R5b)

TYPICAL CHARACTERIZATION CURVES

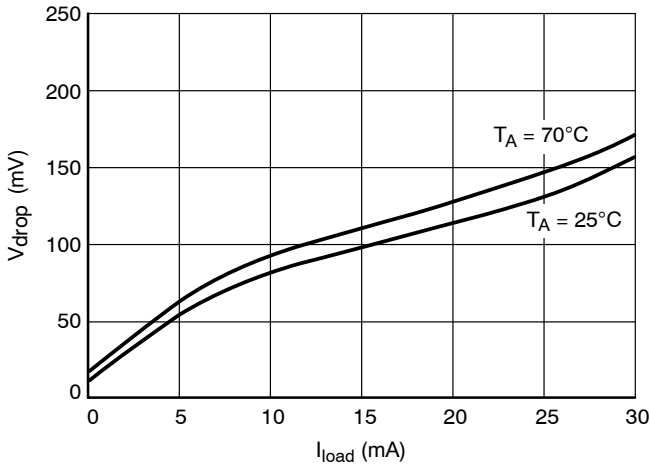

Figure 7. Dropout versus Load Current (Regulators R5a, R6)

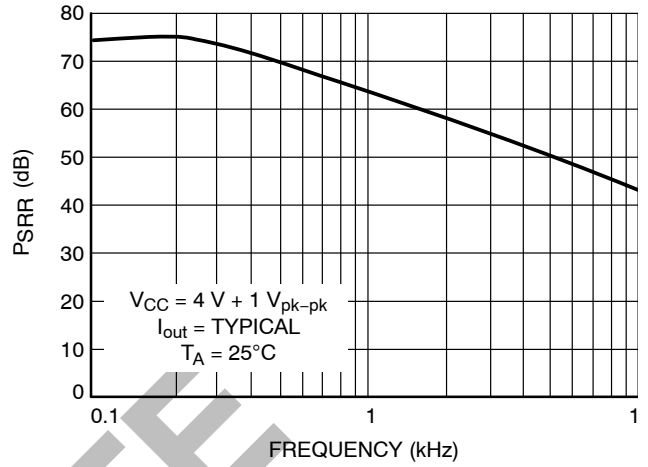

Figure 8. PSRR versus Frequency (All Regulators)

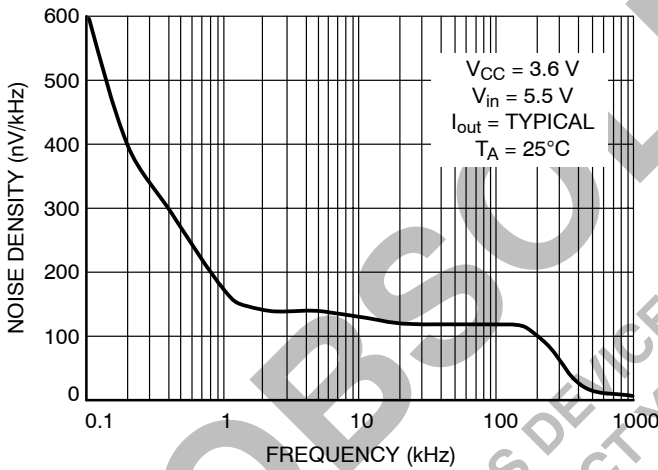

Figure 9. Output Noise Density versus Frequency (Regulators R1, R2, R3, R5a, b)

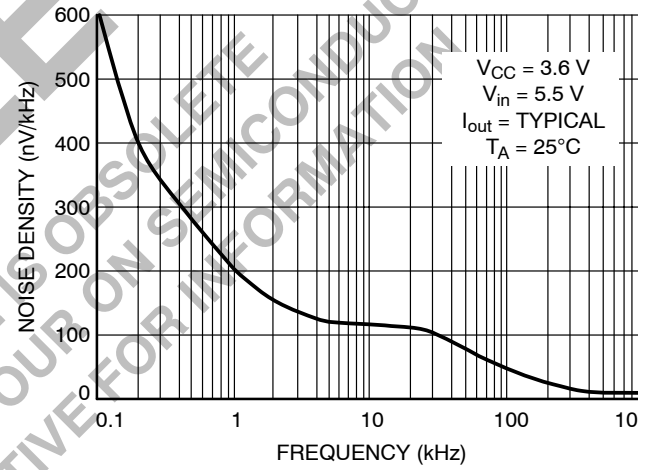

Figure 10. Output Noise Density versus Frequency (Regulators R6, R7)

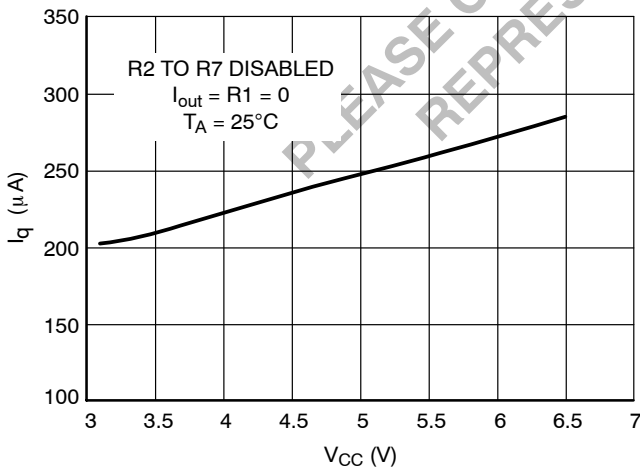

Figure 11. Quiescent Current versus Supply Voltage

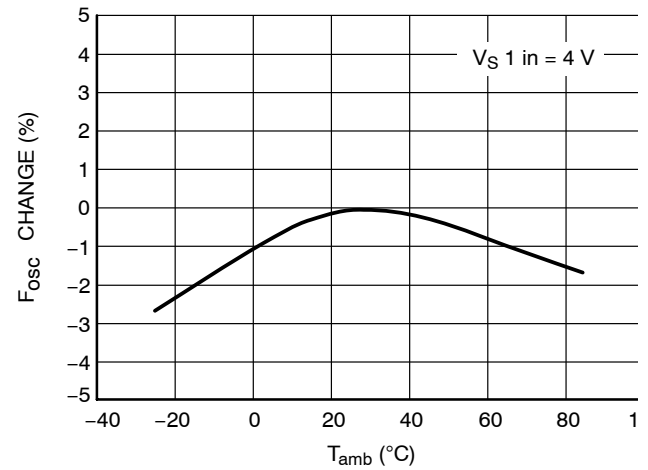

Figure 12. Normalized Charge Pump Oscillator Frequency Change versus Temperature

TYPICAL OSCILLOSCOPE SHOTS

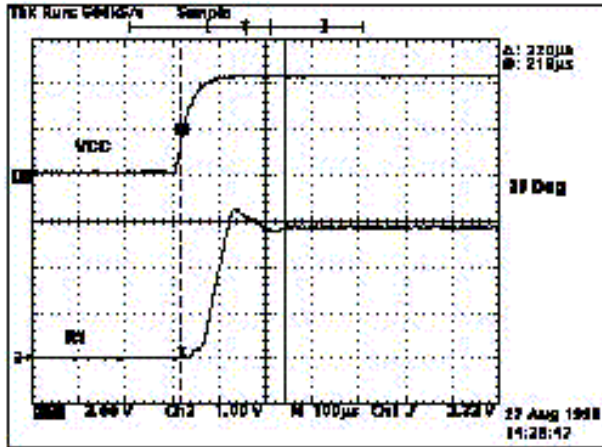

Figure 13. Start-up response: Regulator 1

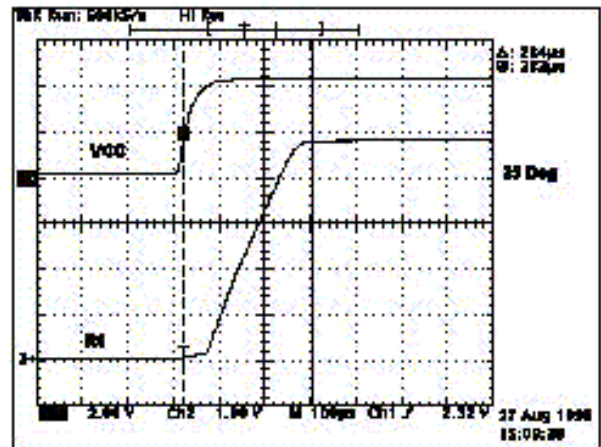

Figure 14. Start-up response: Regulator 6

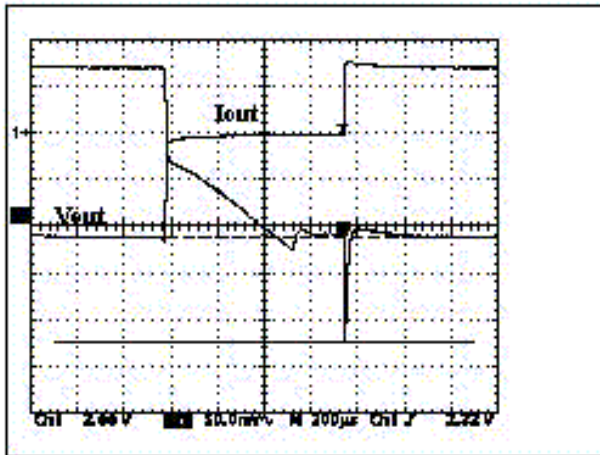

Figure 15. Current step response: Regulator 1

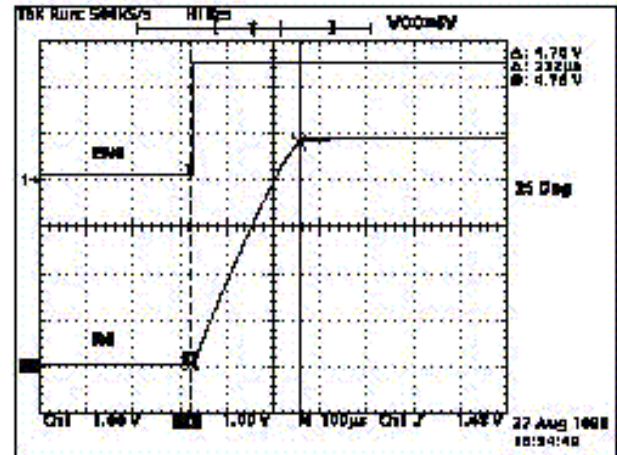

Figure 16. Enable response: Regulator 6

Product Description and Application Hints

Introduction

The MC33283 represents a major lead toward large-scale analog integration. More than a simple multi-output low dropout regulator (LDO), it offers a comprehensive solution to power any portable device such as GSM phones etc.

The system includes four 2.85V regulators featuring different output current capabilities. These regulators are marked R1, R2, R3 and R7 on the simplified block diagram. This configuration ensures an excellent noise isolation between the LDOs and thus between the downstream electronics.

Thanks to the implementation of the charge pump, regulator R6 delivers 5V up to 20mA while the battery is at a lower value. Finally, for maximum flexibility, regulator R5 is a multi-output device in one part: with the help of an external pin, the designer can toggle its value between 4.75V or 2.85V. This regulator is split in two distinct references: R5A and R5B.

Individual selection lines are available to enable/disable each regulator. The IC also delivers logical signals to warn the operating system of any abnormal conditions (low battery etc.)

Regulators R1, R2, R3, R6, and R7

R1, R2 and R3 are set to a 2.85V nominal value (MC33283FTB28). The LDOs exhibit excellent noise characteristics with a typical $40\mu\text{VRMS}$ (10Hz–100kHz) @ $I_{\text{out}} = \text{nominal}$. In a typical GSM application, R1 can be used to charge a backup battery which safely feeds the operating system when the battery is low (e.g. to keep the clock or any configuration data). The commutation between the supplies (the normal battery or the backup one) is ensured by the BUB signal on pin 12. This level goes low when a weak battery is sensed by UVLO1 and accordingly drives an external P-channel gate. Its purpose is to route the safe battery to the system supply.

The regulators accept decoupling capacitors as low as $1\mu\text{F}$ with Equivalent Series Resistor (ESR) varying between $10\text{m}\Omega$ and 3Ω without jeopardizing the regulator's stability.

R1 is only disabled by the UVLO1 circuit when it senses a low battery condition. On the other hand, R2, R3, R6 and R7 can be driven by their respective validation pins.

Regulator R5

R5 is multi-output regulator that can be implemented to supply a SIM connector and adapt its operating voltage to either 2.85V (noted R5B) or 4.75V (noted R5A). The selection of the voltage is simply done via the dedicated SEL pin (18) while R5's logical control is ensured through pin 20 (EN5).

Charge Pump

The charge pump is a stand-alone device. This means that its output can be used to supply another circuitry as long as its maximum current capability is respected (25mA). Operating at a typical 300kHz, it has been designed to lower the injection of high-frequency ripple noise into the battery line. Two separate standard Schottky diodes like the BAT54LT1 can be used to perform the rectification function. If space is of concern, a dual cathode-to-anode BAT54SLT1 will also perfectly suit. The charge pump accepts up to $4.7\mu\text{F}$ filtering capacitor values. These values impact the output ripple and the output transient capability of the charge pump.

As we previously said, the charge pump can supply regulators R5A and R6. In that case, the final charge pump stage (see below drawing) enters the V_{in} pin (14). The 14 pin can also be supplied by an external power supply as long as it fulfills R5A and R6 dropout conditions.

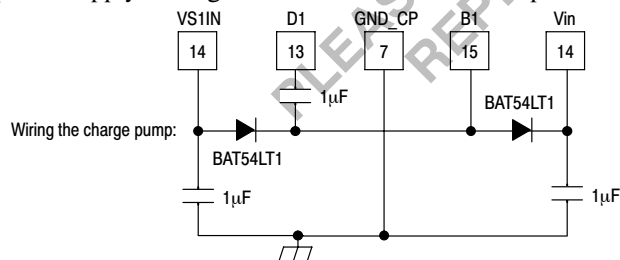

The charge pump is equipped with an overvoltage (OVLO) comparator. If VS1IN is greater than 6.5V, the charge pump function is disabled. A doubled output voltage could damage R5A, R6 regulators, while 6.5V is enough to supply R5A, R6 directly through the charge pump diodes. The common V_{ref} voltage is used, requiring V_{cc2} to be supplied.

To minimize the common impedance noise, the charge pump implements its own ground pin (15) whose return length shall be kept as short as possible.

Internal voltage reference

This reference implements a classical bandgap structure and requires an external bypass capacitor to reduce its noise. A typical ceramic 10nF capacitor will fulfill this function. Please note that this decoupling pin shall not be externally loaded.

Under Voltage Lockouts (UVLOs)

The UVLO1 block monitors the voltage present upon the Vcc2 pin and disables R1 regulator if the battery weakens below 2.72V typical. In that case, R1 is stopped and a low level appears on the BUB pin (12).

UVLO2 also monitors the battery level but does not affect R1. UVLO2 directly drives the R2 through R7 ON/OFF authorizations. The UVLO2 signal goes through an internal AND gate whose other input receives the ENRS level (pin 27). If ENRS is low, UVLO2 pilots R2–R7 ON/OFF authorizations. If ENRS is high, UVLO2 level does no longer affect R2–R7 ON/OFF authorizations.

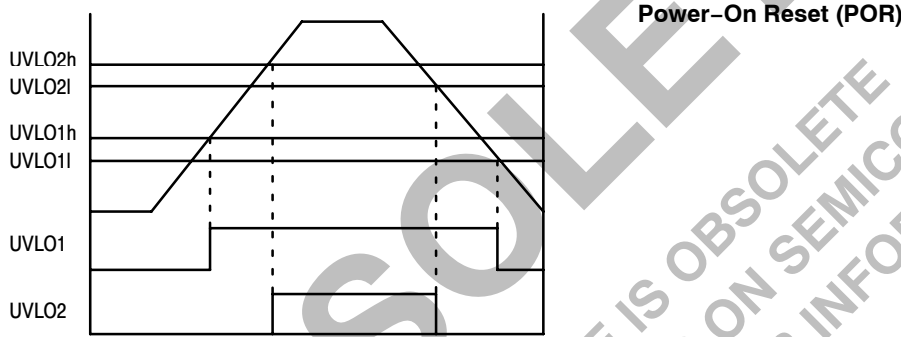

Note: h represents the maximum value while l the minimum

The power-on reset is asserted (low) immediately when the battery voltage drops below the UVLO2 threshold. When the battery voltage rises above this threshold, a typical 5µA current source charges an external capacitor whose value is selected so as to accommodate with any chosen delay.

Overall Chip Enable

If VCC2 is disconnected, the whole chip is disabled, including the voltage reference, the regulators, the charge pump, the under voltage lock out circuits, the power-on reset and the backup battery switch buffer.

Maximum Power Dissipation

The maximum power dissipation is given by the following formula:

$$P_{max} = \frac{T_{Jmax} - T_A}{R_{\theta JA}}$$

Applying this statement with the MC33283 maximum ratings gives a total maximum power of 1W @ T_A = 70°C. This 1W corresponds to the sum of all regulators powers. Individual regulator power is obtained by multiplying its operating dropout by its operating currents, at which you add the input voltage multiplied by the quiescent current:

$$P_{reg} = (V_{in_{reg}} - V_{out_{reg}}) \cdot I_{out_{reg}} + V_{in_{reg}} \cdot I_{quiescent@I_{out}}$$

Total power is then: P_{R1} + P_{R2} + P_{R3} + P_{R5} + P_{R6} + P_{R7} and shall be kept lower than 1W if operating at an ambient temperature of 70°C.

MC33283

OUTLINE DIMENSIONS

FTB SUFFIX
 PLASTIC PACKAGE
 CASE 873B-02
 (TQFP-32)
 ISSUE A

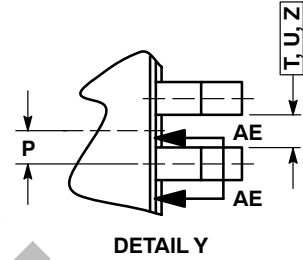
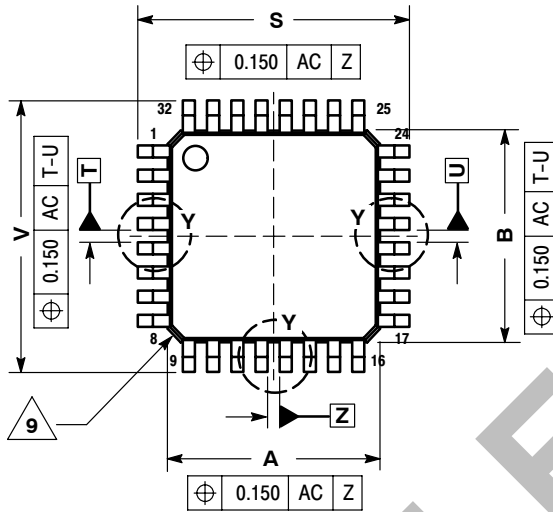

- NOTES:
1. DIMENSIONS AND TOLERANCING PER ASME Y14.5M, 1994.
 2. CONTROLLING DIMENSION: MILLIMETER.
 3. DATUM PLANE AB IS LOCATED AT BOTTOM OF LEAD AND IS COINCIDENT WITH THE LEAD WHERE THE LEAD EXITS THE PLASTIC BODY AT THE BOTTOM OF THE PARTING LINE.
 4. DATUMS T, U AND Z TO BE DETERMINED AT DATUM PLANE AB.
 5. DIMENSIONS S AND V TO BE DETERMINED AT SEATING PLANE AC.
 6. DIMENSIONS A AND B DO NOT INCLUDE MOLD PROTRUSIONS, ALLOWABLE PROTRUSION IS 0.25 PER SIDE. DIMENSIONS A AND B DO INCLUDE MOLD MISMATCH AND ARE DETERMINED AT DATUM PLANE AB.
 7. DIMENSION D DOES NOT INCLUDE DAMBAR PROTRUSION. DAMBAR PROTRUSION SHALL NOT CAUSE THE D DIMENSION TO EXCEED 0.533.
 8. MINIMUM SOLDER PLATE THICKNESS SHALL BE 0.0076.
 9. EXACT SHAPE OF EACH CORNER MAY VARY FROM DEPICTION.

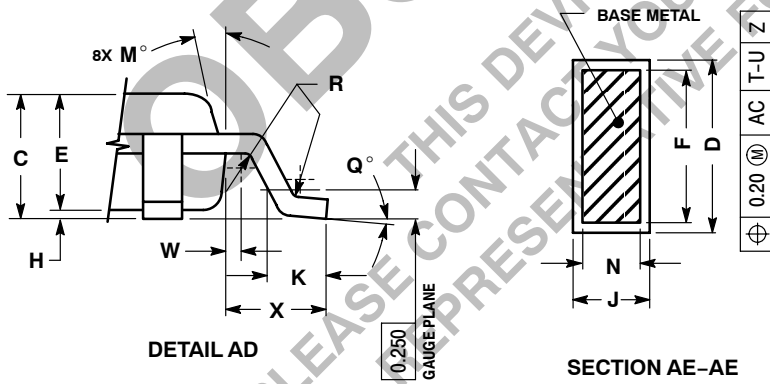
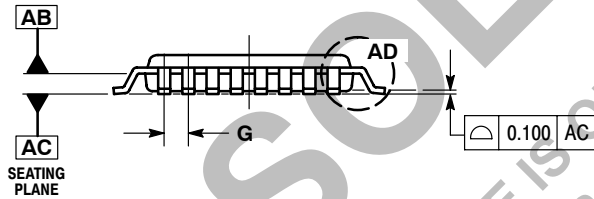

DIM	MILLIMETERS	
	MIN	MAX
A	6.950	7.050
B	6.950	7.050
C	1.000	1.200
D	0.300	0.450
E	0.950	1.050
F	0.300	0.400
G	0.800 BSC	
H	0.050	0.150
J	0.090	0.200
K	0.500	0.700
M	12° REF	
N	0.090	0.178
P	0.400 BSC	
Q	0° - 7°	
R	0.150	0.250
S	8.950	9.050
V	8.950	9.050
W	0.200 REF	
X	1.000 REF	

OBSOLETE
 THIS DEVICE IS OBSOLETE
 PLEASE CONTACT YOUR ON SEMICONDUCTOR
 REPRESENTATIVE FOR INFORMATION

ON Semiconductor and **ON** are registered trademarks of Semiconductor Components Industries, LLC (SCILLC). SCILLC reserves the right to make changes without further notice to any products herein. SCILLC makes no warranty, representation or guarantee regarding the suitability of its products for any particular purpose, nor does SCILLC assume any liability arising out of the application or use of any product or circuit, and specifically disclaims any and all liability, including without limitation special, consequential or incidental damages. "Typical" parameters which may be provided in SCILLC data sheets and/or specifications can and do vary in different applications and actual performance may vary over time. All operating parameters, including "Typicals" must be validated for each customer application by customer's technical experts. SCILLC does not convey any license under its patent rights nor the rights of others. SCILLC products are not designed, intended, or authorized for use as components in systems intended for surgical implant into the body, or other applications intended to support or sustain life, or for any other application in which the failure of the SCILLC product could create a situation where personal injury or death may occur. Should Buyer purchase or use SCILLC products for any such unintended or unauthorized application, Buyer shall indemnify and hold SCILLC and its officers, employees, subsidiaries, affiliates, and distributors harmless against all claims, costs, damages, and expenses, and reasonable attorney fees arising out of, directly or indirectly, any claim of personal injury or death associated with such unintended or unauthorized use, even if such claim alleges that SCILLC was negligent regarding the design or manufacture of the part. SCILLC is an Equal Opportunity/Affirmative Action Employer. This literature is subject to all applicable copyright laws and is not for resale in any manner.

PUBLICATION ORDERING INFORMATION

LITERATURE FULFILLMENT:

Literature Distribution Center for ON Semiconductor
 P.O. Box 5163, Denver, Colorado 80217 USA
Phone: 303-675-2175 or 800-344-3860 Toll Free USA/Canada
Fax: 303-675-2176 or 800-344-3867 Toll Free USA/Canada
Email: orderlit@onsemi.com

N. American Technical Support: 800-282-9855 Toll Free
 USA/Canada
Europe, Middle East and Africa Technical Support:
 Phone: 421 33 790 2910
Japan Customer Focus Center
 Phone: 81-3-5773-3850

ON Semiconductor Website: www.onsemi.com

Order Literature: <http://www.onsemi.com/orderlit>

For additional information, please contact your local Sales Representative