

# MC33272A, MC33274A, NCV33272A, NCV33274A

## Single Supply, High Slew Rate, Low Input Offset Voltage Operational Amplifiers

The MC33272/74 series of monolithic operational amplifiers are quality fabricated with innovative Bipolar design concepts. This dual and quad operational amplifier series incorporates Bipolar inputs along with a patented Zip-R-Trim element for input offset voltage reduction. The MC33272/74 series of operational amplifiers exhibits low input offset voltage and high gain bandwidth product. Dual-doublet frequency compensation is used to increase the slew rate while maintaining low input noise characteristics. Its all NPN output stage exhibits no deadband crossover distortion, large output voltage swing, and an excellent phase and gain margin. It also provides a low open loop high frequency output impedance with symmetrical source and sink AC frequency performance.

### Features

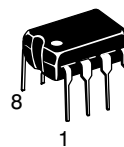
- Input Offset Voltage Trimmed to 100  $\mu\text{V}$  (Typ)
- Low Input Bias Current: 300 nA
- Low Input Offset Current: 3.0 nA
- High Input Resistance: 16 M $\Omega$
- Low Noise: 18 nV/ $\sqrt{\text{Hz}}$  @ 1.0 kHz
- High Gain Bandwidth Product: 24 MHz @ 100 kHz
- High Slew Rate: 10 V/ $\mu\text{s}$
- Power Bandwidth: 160 kHz
- Excellent Frequency Stability
- Unity Gain Stable: w/Capacitance Loads to 500 pF
- Large Output Voltage Swing: +14.1 V/ -14.6 V
- Low Total Harmonic Distortion: 0.003%
- Power Supply Drain Current: 2.15 mA per Amplifier
- Single or Split Supply Operation: +3.0 V to +36 V or  $\pm 1.5$  V to  $\pm 18$  V
- ESD Diodes Provide Added Protection to the Inputs
- NCV Prefix for Automotive and Other Applications Requiring Site and Control Changes
- Pb-Free Packages are Available



ON Semiconductor®

<http://onsemi.com>

### DUAL



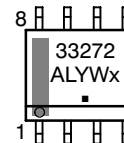
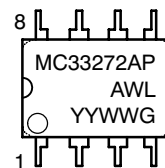
PDIP-8  
P SUFFIX  
CASE 626



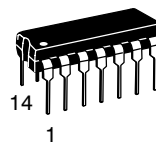
SOIC-8  
D SUFFIX  
CASE 751

x = A for MC33272AD/DR2  
= N for NCV33272ADR2

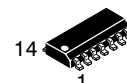
### MARKING DIAGRAMS



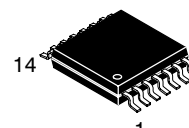
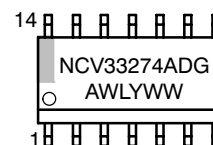
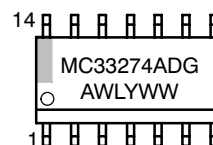
### QUAD



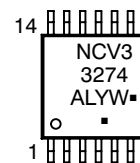
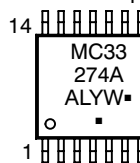
PDIP-14  
P SUFFIX  
CASE 646



SOIC-14  
D SUFFIX  
CASE 751A



TSSOP-14  
DTB SUFFIX  
CASE 948G



A = Assembly Location  
WL, L = Wafer Lot  
YY, Y = Year  
WW, W = Work Week  
G or ▪ = Pb-Free Package

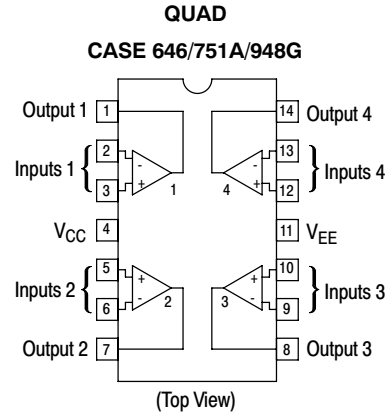
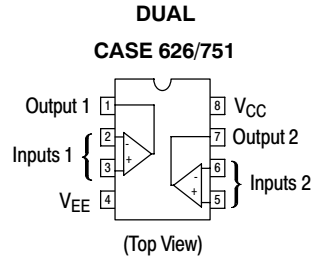
(Note: Microdot may be in either location)

### ORDERING INFORMATION

See detailed ordering and shipping information in the package dimensions section on page 11 of this data sheet.

# MC33272A, MC33274A, NCV33272A, NCV33274A

## PIN CONNECTIONS



## MAXIMUM RATINGS

Rating	Symbol	Value	Unit
Supply Voltage	$V_{CC}$ to $V_{EE}$	+36	V
Input Differential Voltage Range	$V_{IDR}$	Note 1	V
Input Voltage Range	$V_{IR}$	Note 1	V
Output Short Circuit Duration (Note 2)	$t_{SC}$	Indefinite	sec
Maximum Junction Temperature	$T_J$	+150	°C
Storage Temperature	$T_{stg}$	-60 to +150	°C
ESD Protection at Any Pin	$V_{esd}$	2000 200	V
	- Human Body Model - Machine Model		
Maximum Power Dissipation	$P_D$	Note 2	mW
Operating Temperature Range	$T_A$	-40 to +85 -40 to +125	°C
	MC33272A, MC33274A NCV33272A, NCV33274A		

Stresses exceeding Maximum Ratings may damage the device. Maximum Ratings are stress ratings only. Functional operation above the Recommended Operating Conditions is not implied. Extended exposure to stresses above the Recommended Operating Conditions may affect device reliability.

1. Either or both input voltages should not exceed  $V_{CC}$  or  $V_{EE}$ .
2. Power dissipation must be considered to ensure maximum junction temperature ( $T_J$ ) is not exceeded (see Figure 2).

# MC33272A, MC33274A, NCV33272A, NCV33274A

## DC ELECTRICAL CHARACTERISTICS ( $V_{CC} = +15\text{ V}$ , $V_{EE} = -15\text{ V}$ , $T_A = 25^\circ\text{C}$ , unless otherwise noted.)

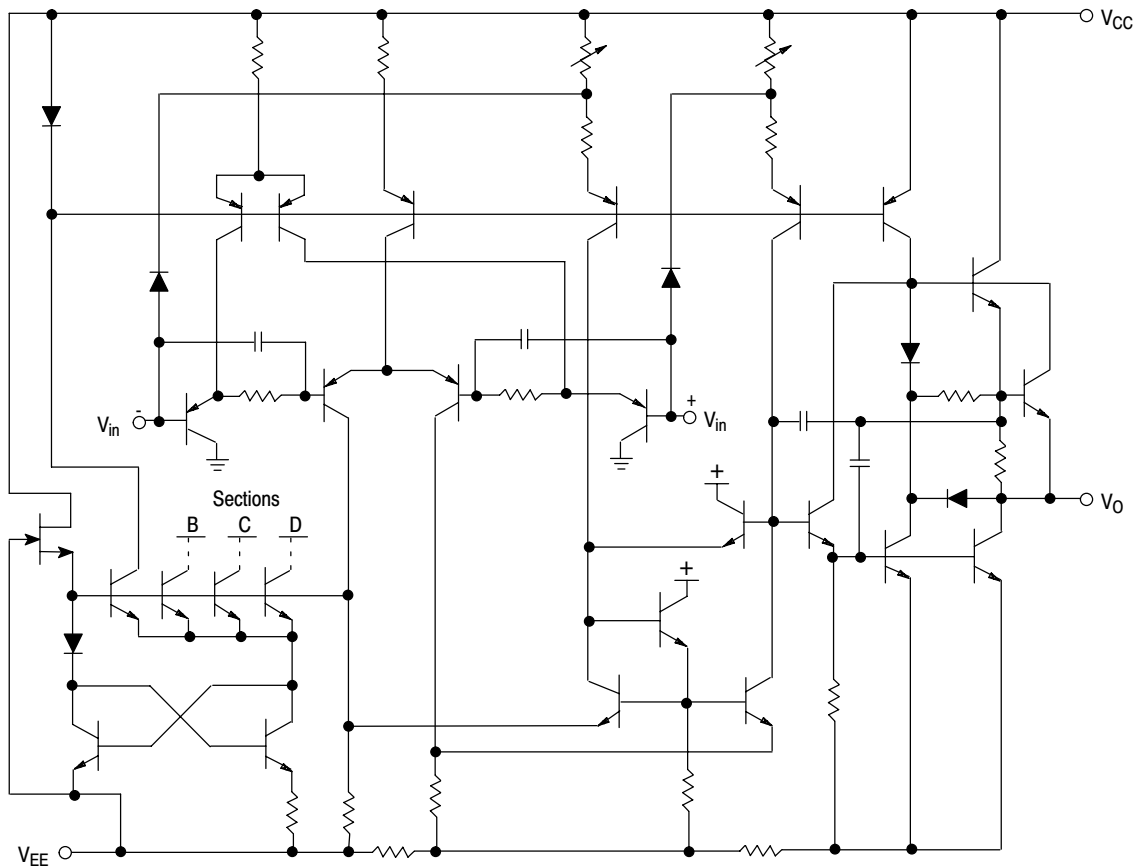
Characteristics	Figure	Symbol	Min	Typ	Max	Unit
Input Offset Voltage ( $R_S = 10\ \Omega$ , $V_{CM} = 0\text{ V}$ , $V_O = 0\text{ V}$ ) ( $V_{CC} = +15\text{ V}$ , $V_{EE} = -15\text{ V}$ ) $T_A = +25^\circ\text{C}$ $T_A = -40^\circ\text{ to }+85^\circ\text{C}$ $T_A = -40^\circ\text{ to }+125^\circ\text{C}$ (NCV33272A) $T_A = -40^\circ\text{ to }+125^\circ\text{C}$ (NCV33274A) ( $V_{CC} = 5.0\text{ V}$ , $V_{EE} = 0$ ) $T_A = +25^\circ\text{C}$	3	$ V_{IO} $	- - - -	0.1 - - -	1.0 1.8 2.5 3.5	mV
Average Temperature Coefficient of Input Offset Voltage $R_S = 10\ \Omega$ , $V_{CM} = 0\text{ V}$ , $V_O = 0\text{ V}$ , $T_A = -40^\circ\text{ to }+125^\circ\text{C}$	3	$\Delta V_{IO}/\Delta T$	-	2.0	-	$\mu\text{V}/^\circ\text{C}$
Input Bias Current ( $V_{CM} = 0\text{ V}$ , $V_O = 0\text{ V}$ ) $T_A = +25^\circ\text{C}$ $T_A = T_{low}\text{ to }T_{high}$	4, 5	$I_{IB}$	- -	300 -	650 800	nA
Input Offset Current ( $V_{CM} = 0\text{ V}$ , $V_O = 0\text{ V}$ ) $T_A = +25^\circ\text{C}$ $T_A = T_{low}\text{ to }T_{high}$		$ I_{IO} $	- -	3.0 -	65 80	nA
Common Mode Input Voltage Range ( $\Delta V_{IO} = 5.0\text{ mV}$ , $V_O = 0\text{ V}$ ) $T_A = +25^\circ\text{C}$	6	$V_{ICR}$	$V_{EE}\text{ to } (V_{CC} - 1.8)$			V
Large Signal Voltage Gain ( $V_O = 0\text{ V to }10\text{ V}$ , $R_L = 2.0\text{ k}\Omega$ ) $T_A = +25^\circ\text{C}$ $T_A = T_{low}\text{ to }T_{high}$	7	$A_{VOL}$	90 86	100 -	- -	dB
Output Voltage Swing ( $V_{ID} = \pm 1.0\text{ V}$ ) ( $V_{CC} = +15\text{ V}$ , $V_{EE} = -15\text{ V}$ ) $R_L = 2.0\text{ k}\Omega$ $R_L = 2.0\text{ k}\Omega$ $R_L = 10\text{ k}\Omega$ $R_L = 10\text{ k}\Omega$ ( $V_{CC} = 5.0\text{ V}$ , $V_{EE} = 0\text{ V}$ ) $R_L = 2.0\text{ k}\Omega$ $R_L = 2.0\text{ k}\Omega$	8, 9, 12     10, 11	$V_{O+}$ $V_{O-}$ $V_{O+}$ $V_{O-}$  $V_{OL}$ $V_{OH}$	13.4 - 13.4 -  - 3.7	13.9 -13.9 14 -14.7  - -	- -13.5 - -14.1  0.2 5.0	V
Common Mode Rejection ( $V_{in} = +13.2\text{ V to }-15\text{ V}$ )	13	CMR	80	100	-	dB
Power Supply Rejection $V_{CC}/V_{EE} = +15\text{ V}/-15\text{ V}$ , $+5.0\text{ V}/-15\text{ V}$ , $+15\text{ V}/-5.0\text{ V}$	14, 15	PSR	80	105	-	dB
Output Short Circuit Current ( $V_{ID} = 1.0\text{ V}$ , Output to Ground) Source Sink	16	$I_{SC}$	+25 -25	+37 -37	- -	mA
Power Supply Current Per Amplifier ( $V_O = 0\text{ V}$ ) ( $V_{CC} = +15\text{ V}$ , $V_{EE} = -15\text{ V}$ ) $T_A = +25^\circ\text{C}$ $T_A = T_{low}\text{ to }T_{high}$ ( $V_{CC} = 5.0\text{ V}$ , $V_{EE} = 0\text{ V}$ ) $T_A = +25^\circ\text{C}$	17	$I_{CC}$	- - -	2.15 - -	2.75 3.0 2.75	mA

3. MC33272A, MC33274A  $T_{low} = -40^\circ\text{C}$   $T_{high} = +85^\circ\text{C}$   
 NCV33272A, NCV33274A  $T_{low} = -40^\circ\text{C}$   $T_{high} = +125^\circ\text{C}$

# MC33272A, MC33274A, NCV33272A, NCV33274A

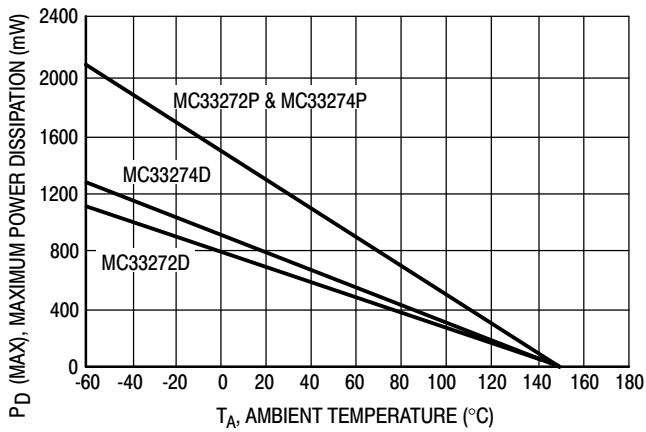
**AC ELECTRICAL CHARACTERISTICS** ( $V_{CC} = +15\text{ V}$ ,  $V_{EE} = -15\text{ V}$ ,  $T_A = 25^\circ\text{C}$ , unless otherwise noted.)

Characteristics	Figure	Symbol	Min	Typ	Max	Unit
Slew Rate ( $V_{in} = -10\text{ V}$ to $+10\text{ V}$ , $R_L = 2.0\text{ k}\Omega$ , $C_L = 100\text{ pF}$ , $A_V = +1.0\text{ V}$ )	18, 33	SR	8.0	10	-	$\text{V}/\mu\text{s}$
Gain Bandwidth Product ( $f = 100\text{ kHz}$ )	19	GBW	17	24	-	MHz
AC Voltage Gain ( $R_L = 2.0\text{ k}\Omega$ , $V_O = 0\text{ V}$ , $f = 20\text{ kHz}$ )	20, 21, 22	$A_{VO}$	-	65	-	dB
Unity Gain Bandwidth (Open Loop)		BW	-	5.5	-	MHz
Gain Margin ( $R_L = 2.0\text{ k}\Omega$ , $C_L = 0\text{ pF}$ )	23, 24, 26	$A_m$	-	12	-	dB
Phase Margin ( $R_L = 2.0\text{ k}\Omega$ , $C_L = 0\text{ pF}$ )	23, 25, 26	$\phi_m$	-	55	-	Deg
Channel Separation ( $f = 20\text{ Hz}$ to $20\text{ kHz}$ )	27	CS	-	-120	-	dB
Power Bandwidth ( $V_O = 20\text{ V}_{pp}$ , $R_L = 2.0\text{ k}\Omega$ , $\text{THD} \leq 1.0\%$ )		$\text{BW}_P$	-	160	-	kHz
Total Harmonic Distortion ( $R_L = 2.0\text{ k}\Omega$ , $f = 20\text{ Hz}$ to $20\text{ kHz}$ , $V_O = 3.0\text{ V}_{rms}$ , $A_V = +1.0$ )	28	THD	-	0.003	-	%
Open Loop Output Impedance ( $V_O = 0\text{ V}$ , $f = 6.0\text{ MHz}$ )	29	$ Z_O $	-	35	-	$\Omega$
Differential Input Resistance ( $V_{CM} = 0\text{ V}$ )		$R_{in}$	-	16	-	$\text{M}\Omega$
Differential Input Capacitance ( $V_{CM} = 0\text{ V}$ )		$C_{in}$	-	3.0	-	pF
Equivalent Input Noise Voltage ( $R_S = 100\ \Omega$ , $f = 1.0\text{ kHz}$ )	30	$e_n$	-	18	-	$\text{nV}/\sqrt{\text{Hz}}$
Equivalent Input Noise Current ( $f = 1.0\text{ kHz}$ )	31	$i_n$	-	0.5	-	$\text{pA}/\sqrt{\text{Hz}}$

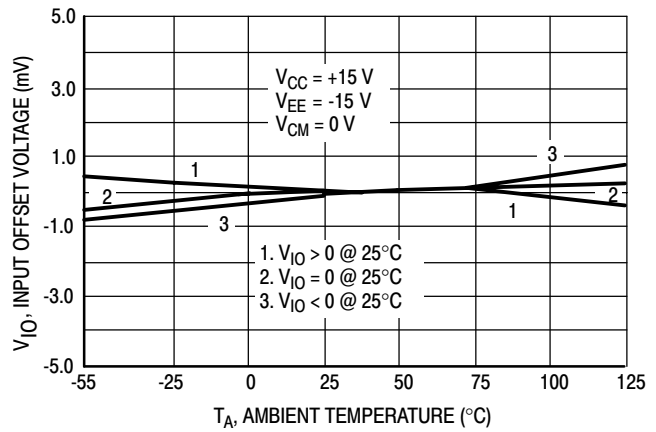


**Figure 1. Equivalent Circuit Schematic**  
(Each Amplifier)

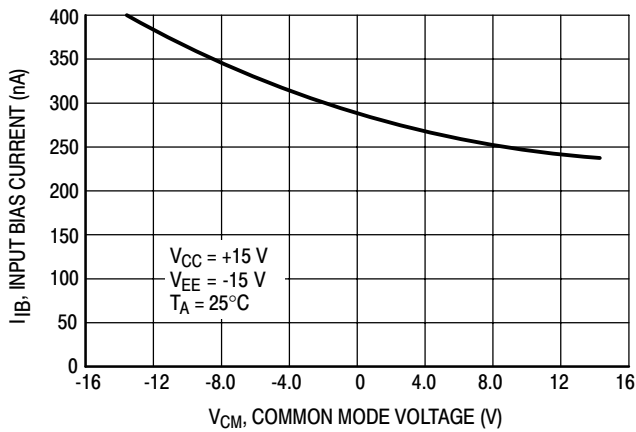
# MC33272A, MC33274A, NCV33272A, NCV33274A



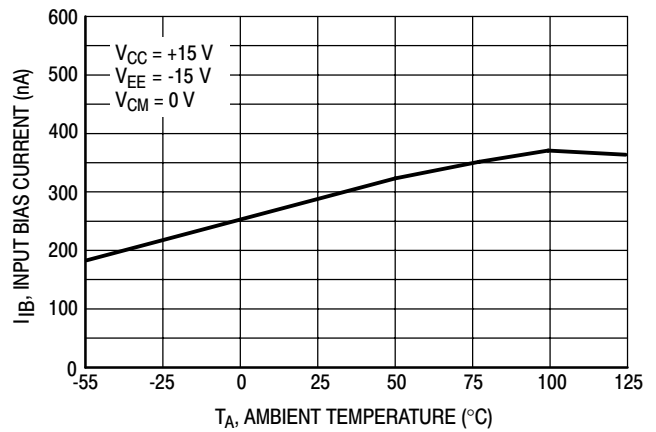
**Figure 2. Maximum Power Dissipation versus Temperature**



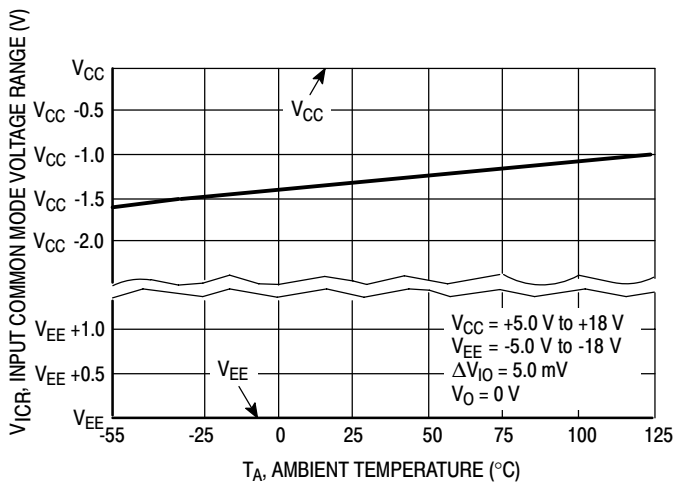
**Figure 3. Input Offset Voltage versus Temperature for Typical Units**



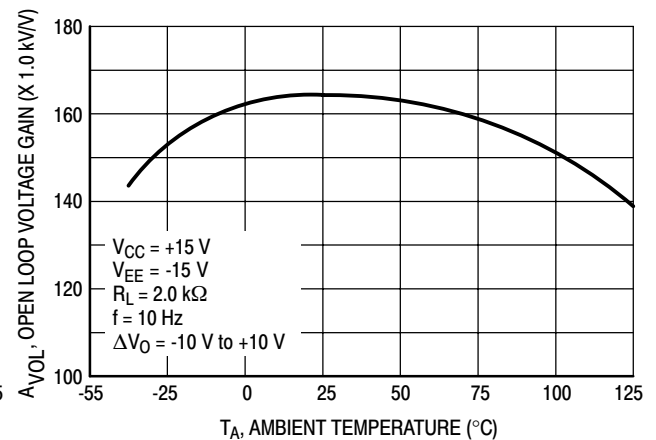
**Figure 4. Input Bias Current versus Common Mode Voltage**



**Figure 5. Input Bias Current versus Temperature**



**Figure 6. Input Common Mode Voltage Range versus Temperature**



**Figure 7. Open Loop Voltage Gain versus Temperature**

MC33272A, MC33274A, NCV33272A, NCV33274A

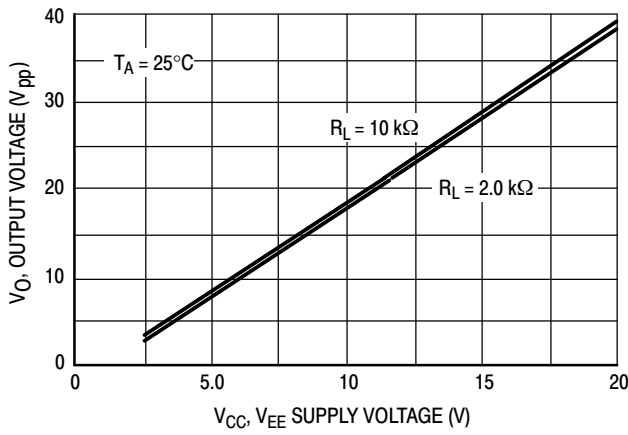


Figure 8. Split Supply Output Voltage Swing versus Supply Voltage

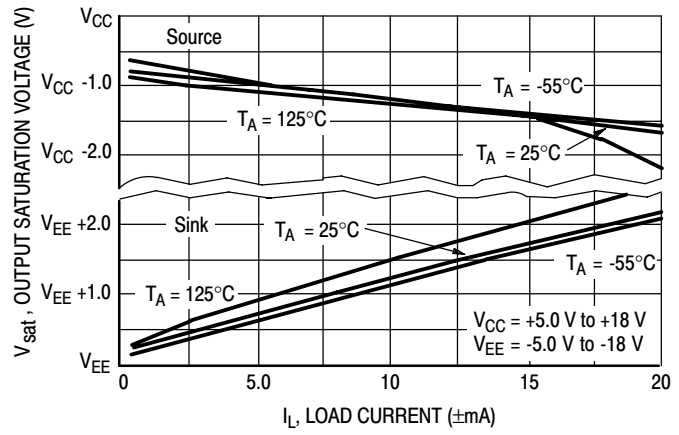


Figure 9. Split Supply Output Saturation Voltage versus Load Current

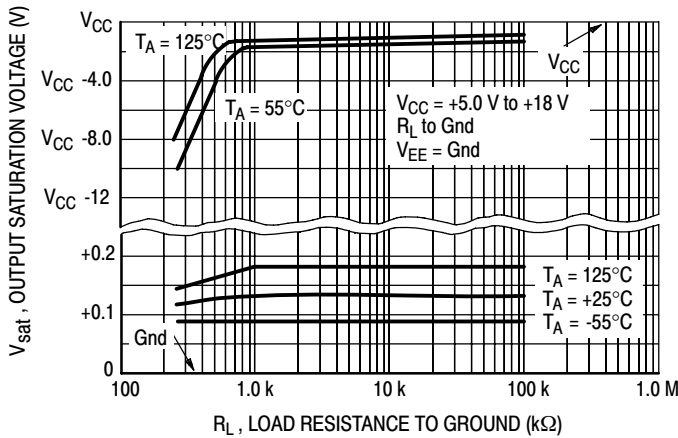


Figure 10. Single Supply Output Saturation Voltage versus Load Resistance to Ground

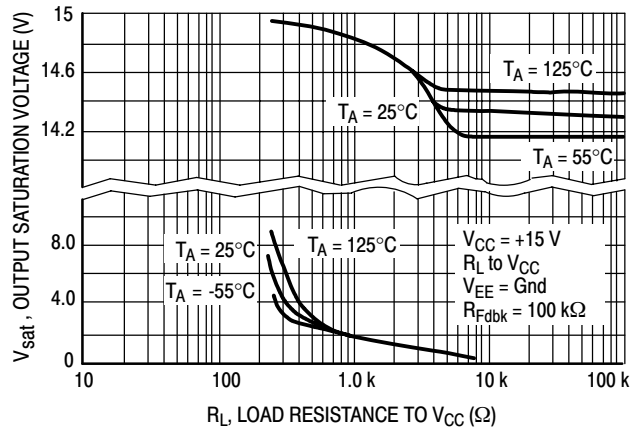


Figure 11. Single Supply Output Saturation Voltage versus Load Resistance to V<sub>CC</sub>

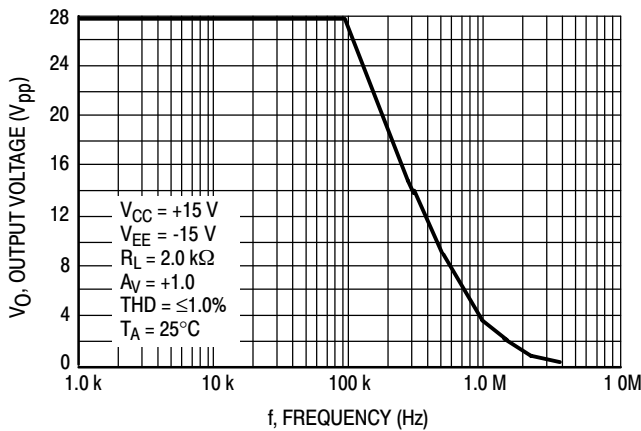


Figure 12. Output Voltage versus Frequency

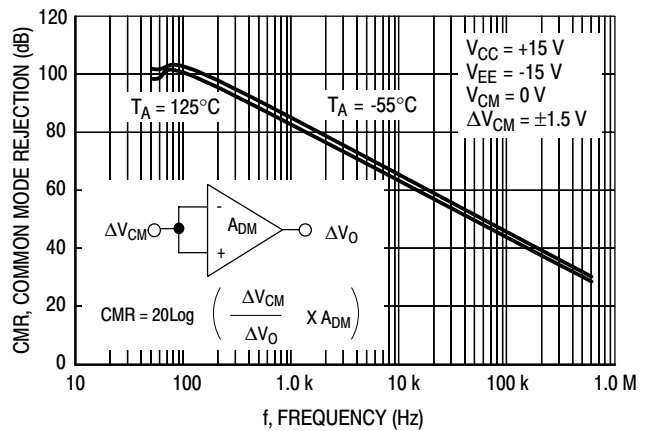


Figure 13. Common Mode Rejection versus Frequency

MC33272A, MC33274A, NCV33272A, NCV33274A

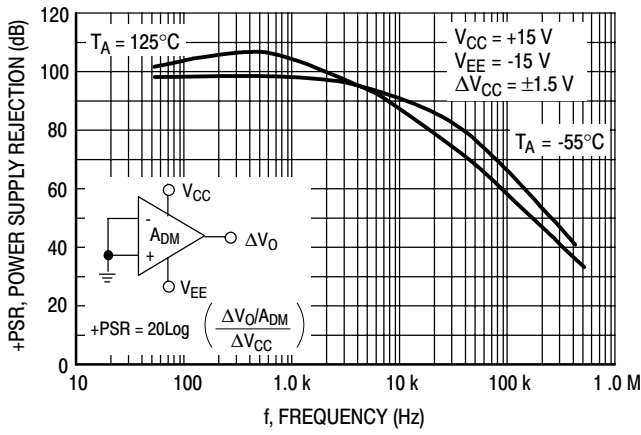


Figure 14. Positive Power Supply Rejection versus Frequency

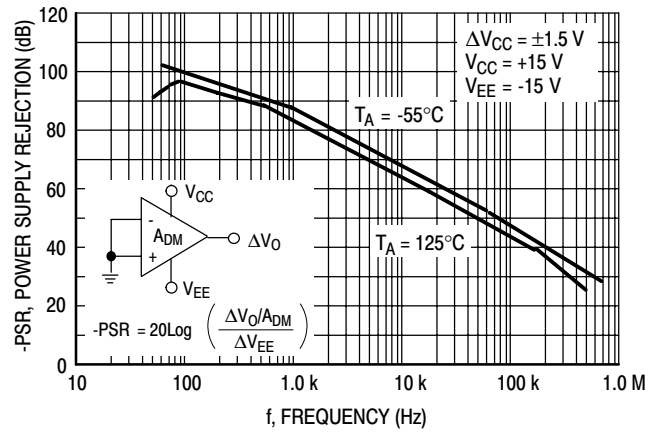


Figure 15. Negative Power Supply Rejection versus Frequency

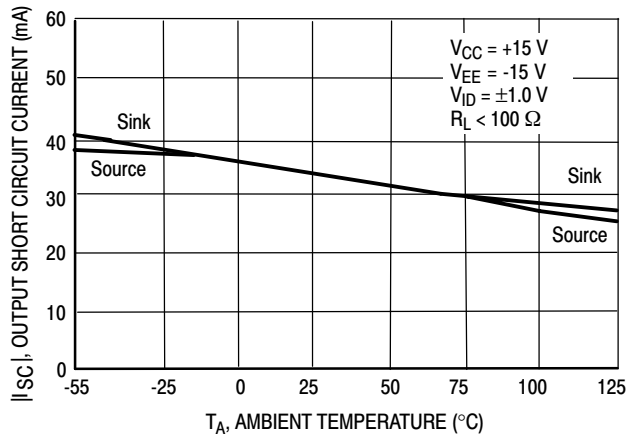


Figure 16. Output Short Circuit Current versus Temperature

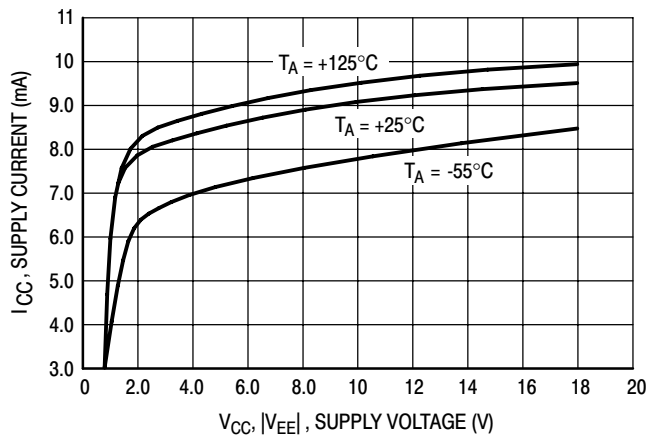


Figure 17. Supply Current versus Supply Voltage

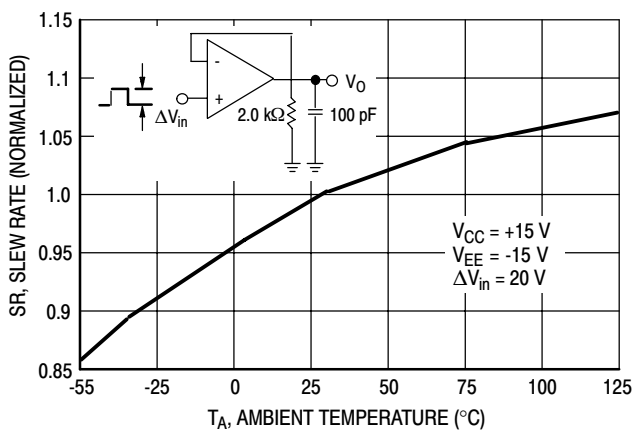


Figure 18. Normalized Slew Rate versus Temperature

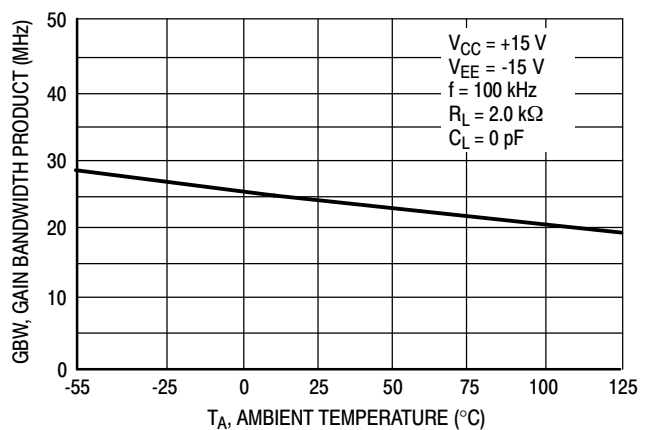
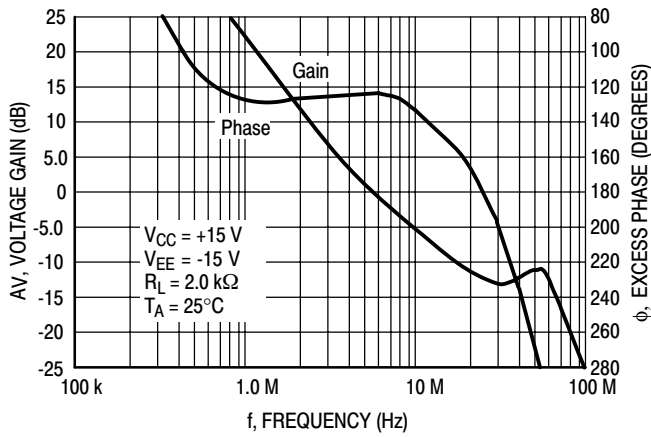
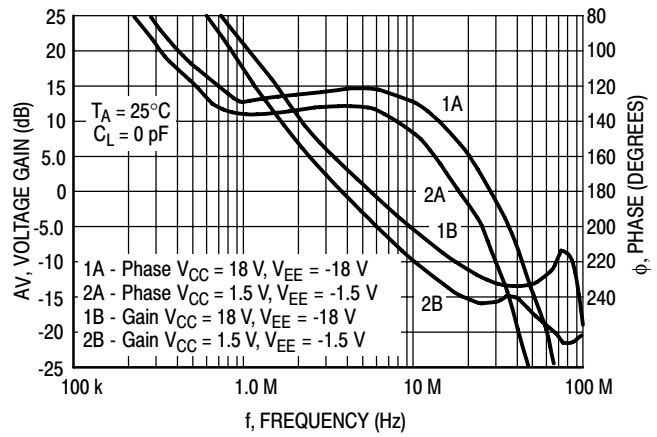


Figure 19. Gain Bandwidth Product versus Temperature

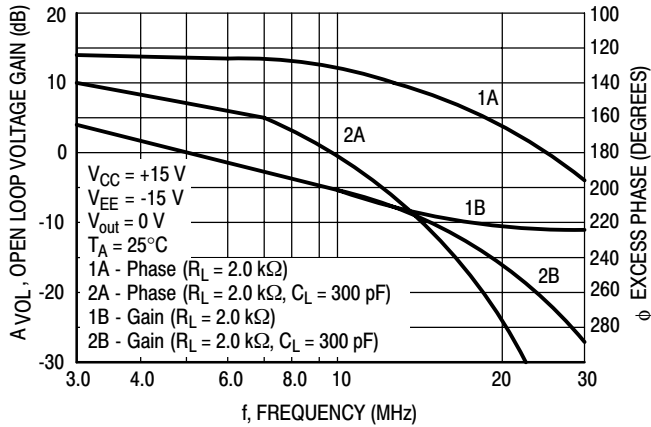
# MC33272A, MC33274A, NCV33272A, NCV33274A



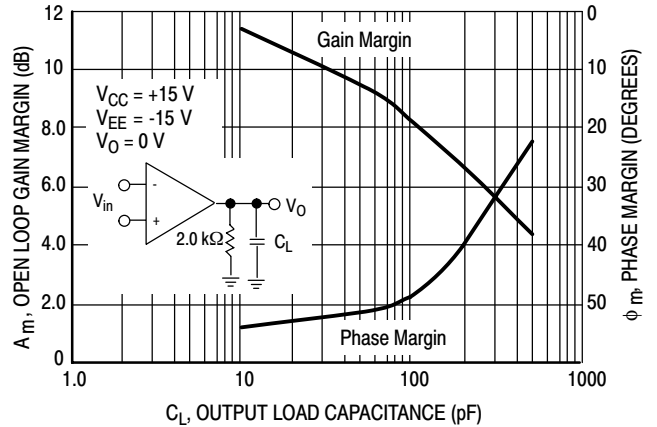
**Figure 20. Voltage Gain and Phase versus Frequency**



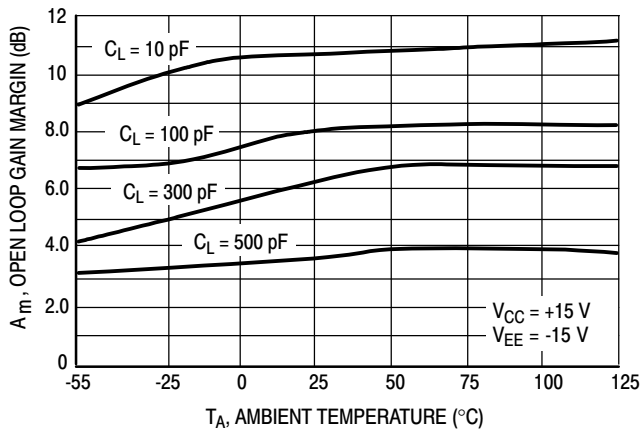
**Figure 21. Gain and Phase versus Frequency**



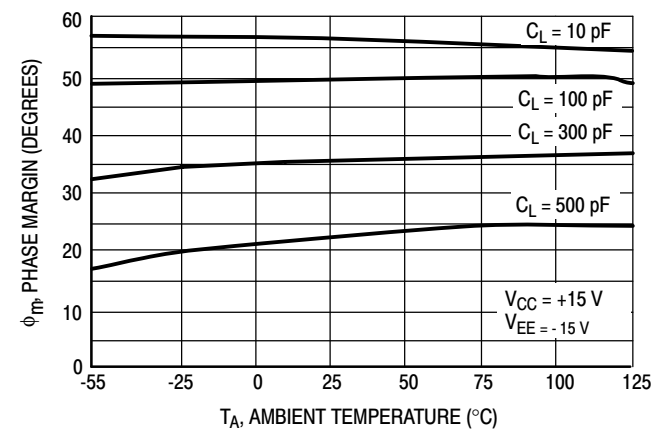
**Figure 22. Open Loop Voltage Gain and Phase versus Frequency**



**Figure 23. Open Loop Gain Margin and Phase Margin versus Output Load Capacitance**



**Figure 24. Open Loop Gain Margin versus Temperature**



**Figure 25. Phase Margin versus Temperature**



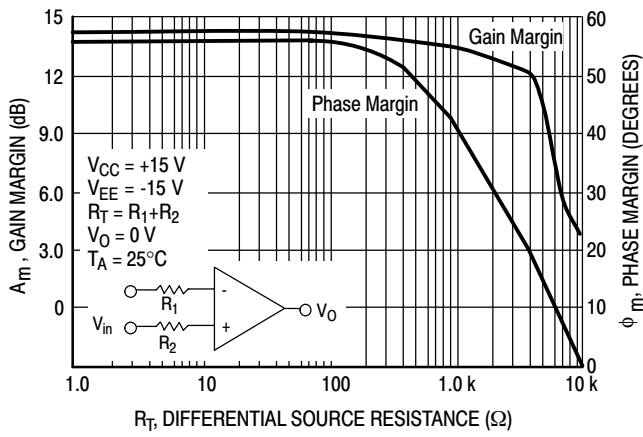


Figure 26. Phase Margin and Gain Margin versus Differential Source Resistance

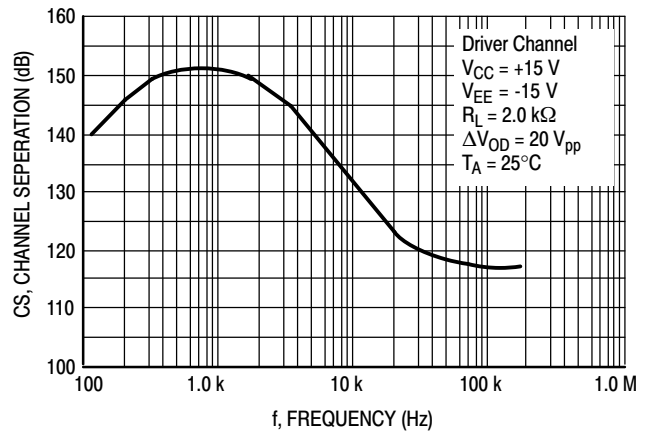


Figure 27. Channel Separation versus Frequency

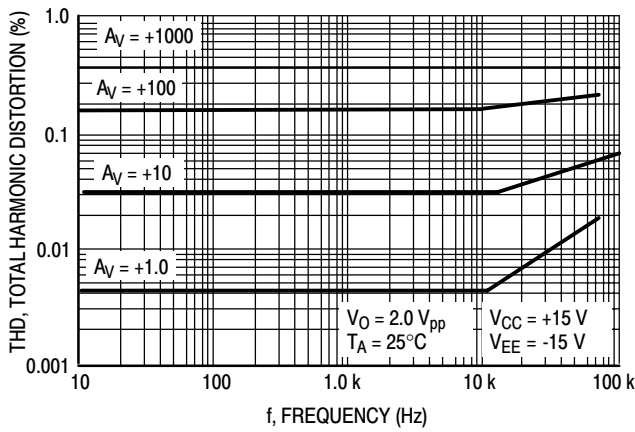


Figure 28. Total Harmonic Distortion versus Frequency

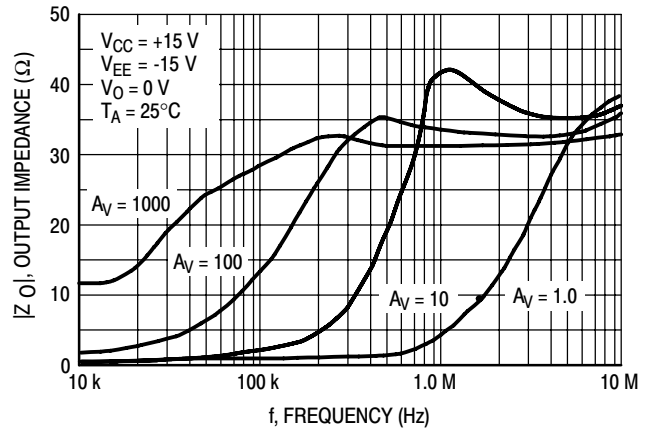


Figure 29. Output Impedance versus Frequency

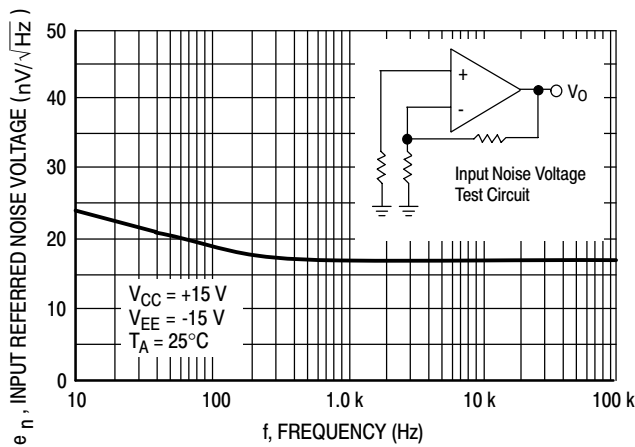


Figure 30. Input Referred Noise Voltage versus Frequency

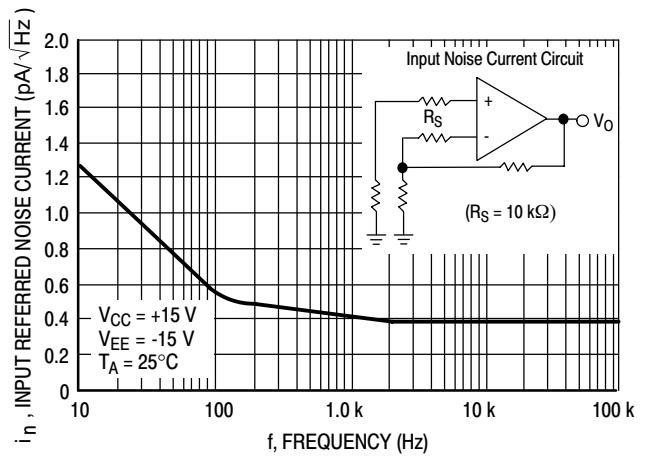


Figure 31. Input Referred Noise Current versus Frequency

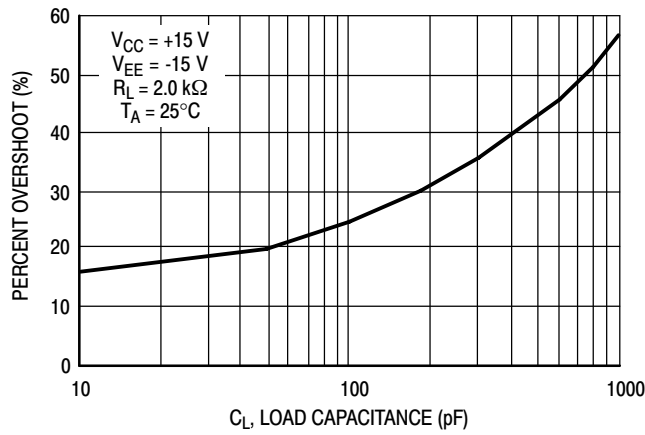


Figure 32. Percent Overshoot versus Load Capacitance

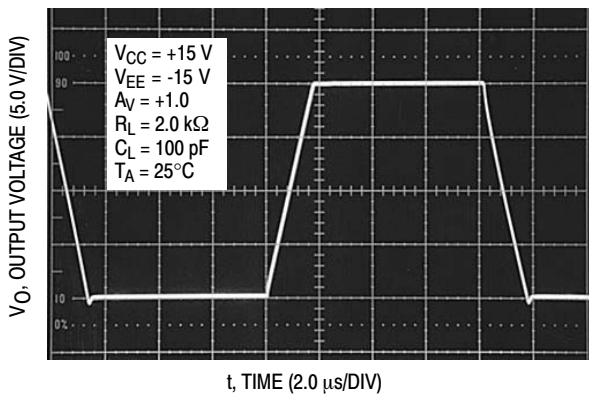


Figure 33. Non-inverting Amplifier Slew Rate for the MC33274

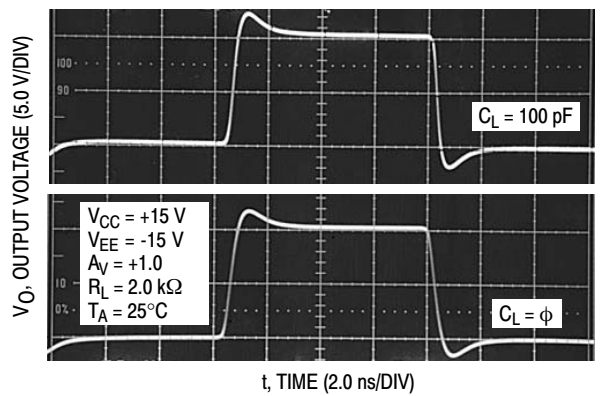


Figure 34. Non-inverting Amplifier Overshoot for the MC33274

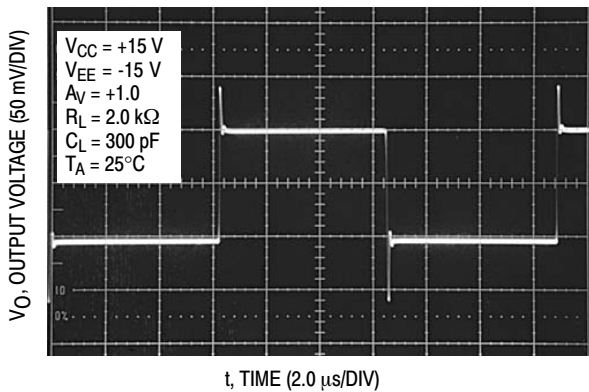


Figure 35. Small Signal Transient Response for MC33274

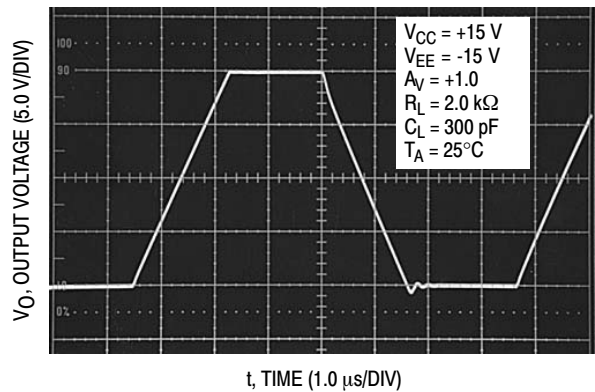


Figure 36. Large Signal Transient Response for MC33274

## MC33272A, MC33274A, NCV33272A, NCV33274A

### ORDERING INFORMATION

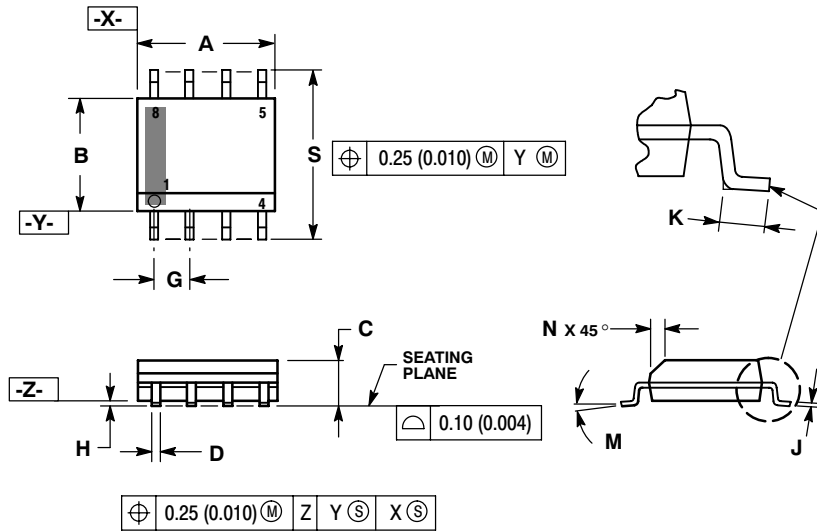
Device	Package	Shipping†
MC33272AD	SOIC-8	98 Units / Rail
MC33272ADG	SOIC-8 (Pb-Free)	
MC33272ADR2	SOIC-8	2500 / Tape & Reel
MC33272ADR2G	SOIC-8 (Pb-Free)	
MC33272AP	PDIP-8	50 Units / Rail
MC33272APG	PDIP-8 (Pb-Free)	
NCV33272ADR2*	SOIC-8	2500 / Tape & Reel
NCV33272ADR2G*	SOIC-8 (Pb-Free)	
MC33274AD	SOIC-14	55 Units / Rail
MC33274ADG	SOIC-14 (Pb-Free)	
MC33274ADR2	SOIC-14	2500 / Tape & Reel
MC33274ADR2G	SOIC-14 (Pb-Free)	
MC33274ADTBR2G	SOIC-14 (Pb-Free)	
MC33274AP	PDIP-14	25 Units / Rail
MC33274APG	PDIP-14 (Pb-Free)	
NCV33274AD*	SOIC-14	55 Units / Rail
NCV33274ADG*	SOIC-14 (Pb-Free)	
NCV33274ADR2*	SOIC-14	2500 / Tape & Reel
NCV33274ADR2G*	SOIC-14 (Pb-Free)	
NCV33274ADTBR2G*	TSSOP-14 (Pb-Free)	

†For information on tape and reel specifications, including part orientation and tape sizes, please refer to our Tape and Reel Packaging Specifications Brochure, BRD8011/D.

\*NCV prefix for automotive and other applications requiring site and control changes.

PACKAGE DIMENSIONS

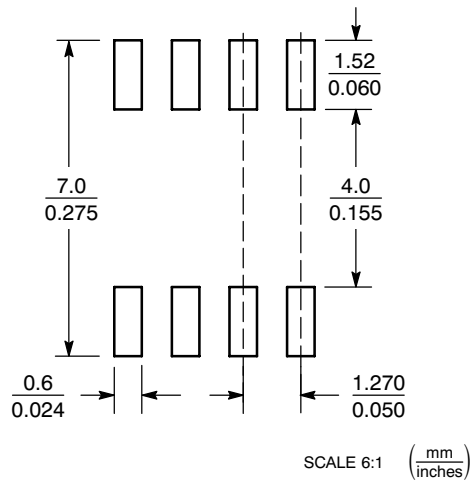
SOIC-8 NB  
CASE 751-07  
ISSUE AH



- NOTES:
1. DIMENSIONING AND TOLERANCING PER ANSI Y14.5M, 1982.
  2. CONTROLLING DIMENSION: MILLIMETER.
  3. DIMENSION A AND B DO NOT INCLUDE MOLD PROTRUSION.
  4. MAXIMUM MOLD PROTRUSION 0.15 (0.006) PER SIDE.
  5. DIMENSION D DOES NOT INCLUDE DAMBAR PROTRUSION. ALLOWABLE DAMBAR PROTRUSION SHALL BE 0.127 (0.005) TOTAL IN EXCESS OF THE D DIMENSION AT MAXIMUM MATERIAL CONDITION.
  6. 751-01 THRU 751-06 ARE OBSOLETE. NEW STANDARD IS 751-07.

DIM	MILLIMETERS		INCHES	
	MIN	MAX	MIN	MAX
A	4.80	5.00	0.189	0.197
B	3.80	4.00	0.150	0.157
C	1.35	1.75	0.053	0.069
D	0.33	0.51	0.013	0.020
G	1.27 BSC		0.050 BSC	
H	0.10	0.25	0.004	0.010
J	0.19	0.25	0.007	0.010
K	0.40	1.27	0.016	0.050
M	0°	8°	0°	8°
N	0.25	0.50	0.010	0.020
S	5.80	6.20	0.228	0.244

SOLDERING FOOTPRINT\*

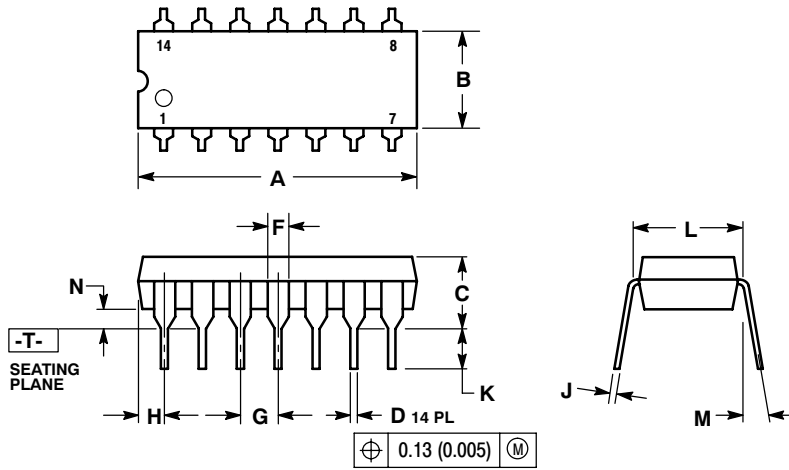


\*For additional information on our Pb-Free strategy and soldering details, please download the ON Semiconductor Soldering and Mounting Techniques Reference Manual, SOLDERRM/D.

# MC33272A, MC33274A, NCV33272A, NCV33274A

## PACKAGE DIMENSIONS

**PDIP-14**  
CASE 646-06  
ISSUE P



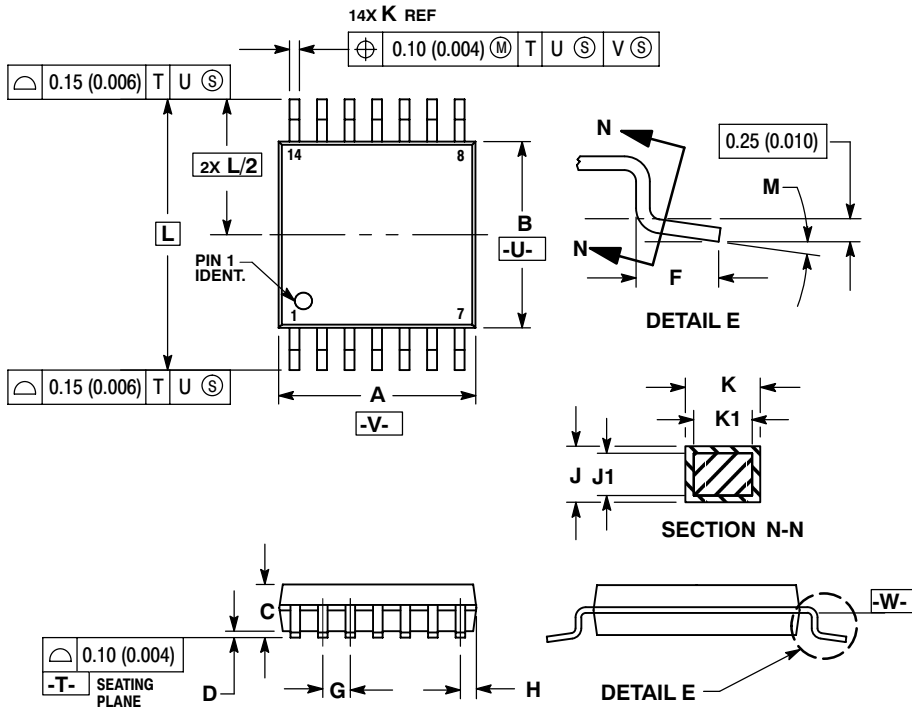
**NOTES:**

1. DIMENSIONING AND TOLERANCING PER ANSI Y14.5M, 1982.
2. CONTROLLING DIMENSION: INCH.
3. DIMENSION L TO CENTER OF LEADS WHEN FORMED PARALLEL.
4. DIMENSION B DOES NOT INCLUDE MOLD FLASH.
5. ROUNDED CORNERS OPTIONAL.

DIM	INCHES		MILLIMETERS	
	MIN	MAX	MIN	MAX
A	0.715	0.770	18.16	19.56
B	0.240	0.260	6.10	6.60
C	0.145	0.185	3.69	4.69
D	0.015	0.021	0.38	0.53
F	0.040	0.070	1.02	1.78
G	0.100 BSC		2.54 BSC	
H	0.052	0.095	1.32	2.41
J	0.008	0.015	0.20	0.38
K	0.115	0.135	2.92	3.43
L	0.290	0.310	7.37	7.87
M	---	10°	---	10°
N	0.015	0.039	0.38	1.01

# MC33272A, MC33274A, NCV33272A, NCV33274A

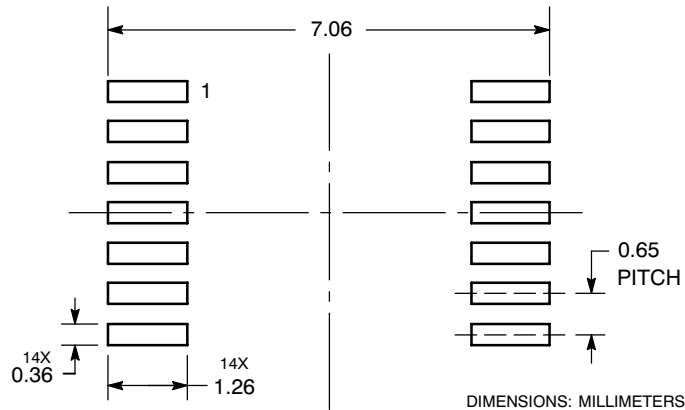
## TSSOP-14 CASE 948G-01 ISSUE B



- NOTES:
1. DIMENSIONING AND TOLERANCING PER ANSI Y14.5M, 1982.
  2. CONTROLLING DIMENSION: MILLIMETER.
  3. DIMENSION A DOES NOT INCLUDE MOLD FLASH, PROTRUSIONS OR GATE BURRS. MOLD FLASH OR GATE BURRS SHALL NOT EXCEED  $0.15 (0.006)$  PER SIDE.
  4. DIMENSION B DOES NOT INCLUDE INTERLEAD FLASH OR PROTRUSION. INTERLEAD FLASH OR PROTRUSION SHALL NOT EXCEED  $0.25 (0.010)$  PER SIDE.
  5. DIMENSION K DOES NOT INCLUDE DAMBAR PROTRUSION. ALLOWABLE DAMBAR PROTRUSION SHALL BE  $0.08 (0.003)$  TOTAL IN EXCESS OF THE K DIMENSION AT MAXIMUM MATERIAL CONDITION.
  6. TERMINAL NUMBERS ARE SHOWN FOR REFERENCE ONLY.
  7. DIMENSION A AND B ARE TO BE DETERMINED AT DATUM PLANE -W-.

DIM	MILLIMETERS		INCHES	
	MIN	MAX	MIN	MAX
A	4.90	5.10	0.193	0.200
B	4.30	4.50	0.169	0.177
C	---	1.20	---	0.047
D	0.05	0.15	0.002	0.006
F	0.50	0.75	0.020	0.030
G	0.65 BSC		0.026 BSC	
H	0.50	0.60	0.020	0.024
J	0.09	0.20	0.004	0.008
J1	0.09	0.16	0.004	0.006
K	0.19	0.30	0.007	0.012
K1	0.19	0.25	0.007	0.010
L	6.40 BSC		0.252 BSC	
M	0° 8°		0° 8°	

### SOLDERING FOOTPRINT\*

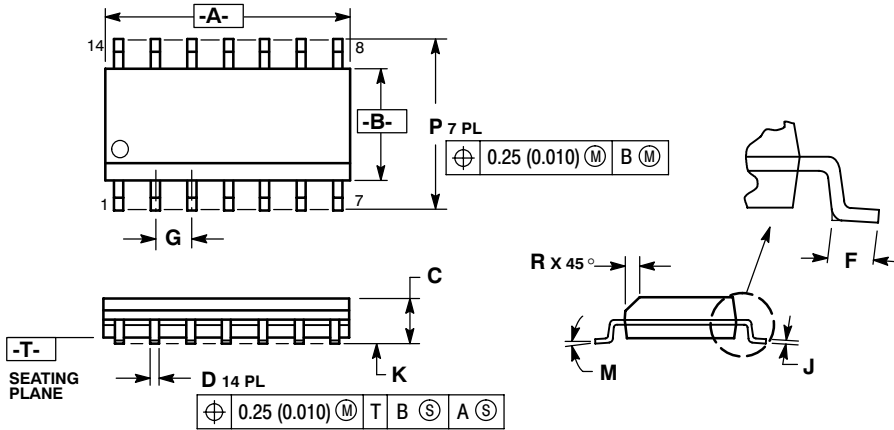


\*For additional information on our Pb-Free strategy and soldering details, please download the ON Semiconductor Soldering and Mounting Techniques Reference Manual, SOLDERRM/D.

# MC33272A, MC33274A, NCV33272A, NCV33274A

## PACKAGE DIMENSIONS

SOIC-14  
CASE 751A-03  
ISSUE H

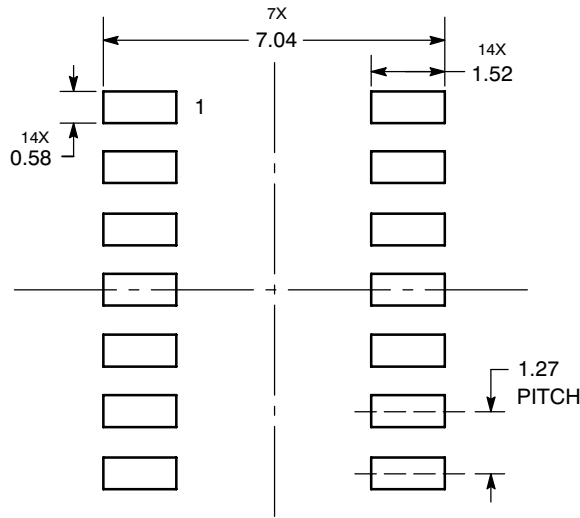


**NOTES:**

1. DIMENSIONING AND TOLERANCING PER ANSI Y14.5M, 1982.
2. CONTROLLING DIMENSION: MILLIMETER.
3. DIMENSIONS A AND B DO NOT INCLUDE MOLD PROTRUSION.
4. MAXIMUM MOLD PROTRUSION 0.15 (0.006) PER SIDE.
5. DIMENSION D DOES NOT INCLUDE DAMBAR PROTRUSION. ALLOWABLE DAMBAR PROTRUSION SHALL BE 0.127 (0.005) TOTAL IN EXCESS OF THE D DIMENSION AT MAXIMUM MATERIAL CONDITION.

DIM	MILLIMETERS		INCHES	
	MIN	MAX	MIN	MAX
A	8.55	8.75	0.337	0.344
B	3.80	4.00	0.150	0.157
C	1.35	1.75	0.054	0.068
D	0.35	0.49	0.014	0.019
F	0.40	1.25	0.016	0.049
G	1.27 BSC		0.050 BSC	
J	0.19	0.25	0.008	0.009
K	0.10	0.25	0.004	0.009
M	0°	7°	0°	7°
P	5.80	6.20	0.228	0.244
R	0.25	0.50	0.010	0.019

### SOLDERING FOOTPRINT\*



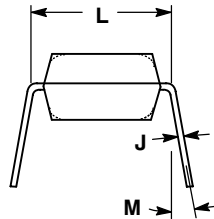
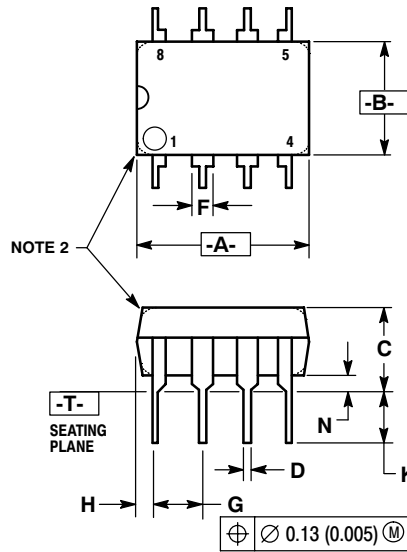
DIMENSIONS: MILLIMETERS

\*For additional information on our Pb-Free strategy and soldering details, please download the ON Semiconductor Soldering and Mounting Techniques Reference Manual, SOLDERRM/D.

# MC33272A, MC33274A, NCV33272A, NCV33274A

## PACKAGE DIMENSIONS

PDIP-8  
P SUFFIX  
CASE 626-05  
ISSUE L



NOTES:

1. DIMENSION L TO CENTER OF LEAD WHEN FORMED PARALLEL.
2. PACKAGE CONTOUR OPTIONAL (ROUND OR SQUARE CORNERS).
3. DIMENSIONING AND TOLERANCING PER ANSI Y14.5M, 1982.

DIM	MILLIMETERS		INCHES	
	MIN	MAX	MIN	MAX
A	9.40	10.16	0.370	0.400
B	6.10	6.60	0.240	0.260
C	3.94	4.45	0.155	0.175
D	0.38	0.51	0.015	0.020
F	1.02	1.78	0.040	0.070
G	2.54 BSC		0.100 BSC	
H	0.76	1.27	0.030	0.050
J	0.20	0.30	0.008	0.012
K	2.92	3.43	0.115	0.135
L	7.62 BSC		0.300 BSC	
M	---	10°	---	10°
N	0.76	1.01	0.030	0.040

ON Semiconductor and are registered trademarks of Semiconductor Components Industries, LLC (SCILLC). SCILLC reserves the right to make changes without further notice to any products herein. SCILLC makes no warranty, representation or guarantee regarding the suitability of its products for any particular purpose, nor does SCILLC assume any liability arising out of the application or use of any product or circuit, and specifically disclaims any and all liability, including without limitation special, consequential or incidental damages. "Typical" parameters which may be provided in SCILLC data sheets and/or specifications can and do vary in different applications and actual performance may vary over time. All operating parameters, including "Typicals" must be validated for each customer application by customer's technical experts. SCILLC does not convey any license under its patent rights nor the rights of others. SCILLC products are not designed, intended, or authorized for use as components in systems intended for surgical implant into the body, or other applications intended to support or sustain life, or for any other application in which the failure of the SCILLC product could create a situation where personal injury or death may occur. Should Buyer purchase or use SCILLC products for any such unintended or unauthorized application, Buyer shall indemnify and hold SCILLC and its officers, employees, subsidiaries, affiliates, and distributors harmless against all claims, costs, damages, and expenses, and reasonable attorney fees arising out of, directly or indirectly, any claim of personal injury or death associated with such unintended or unauthorized use, even if such claim alleges that SCILLC was negligent regarding the design or manufacture of the part. SCILLC is an Equal Opportunity/Affirmative Action Employer. This literature is subject to all applicable copyright laws and is not for resale in any manner.

### PUBLICATION ORDERING INFORMATION

**LITERATURE FULFILLMENT:**  
Literature Distribution Center for ON Semiconductor  
P.O. Box 5163, Denver, Colorado 80217 USA  
**Phone:** 303-675-2175 or 800-344-3860 Toll Free USA/Canada  
**Fax:** 303-675-2176 or 800-344-3867 Toll Free USA/Canada  
**Email:** orderlit@onsemi.com

**N. American Technical Support:** 800-282-9855 Toll Free USA/Canada  
**Europe, Middle East and Africa Technical Support:**  
Phone: 421 33 790 2910  
**Japan Customer Focus Center**  
Phone: 81-3-5773-3850

**ON Semiconductor Website:** [www.onsemi.com](http://www.onsemi.com)  
**Order Literature:** <http://www.onsemi.com/orderlit>

For additional information, please contact your local Sales Representative

MC33272A/D