

Dual Output Low ESR Cap. Low-Dropout 150mA Linear Regulator

FEATURES

- Up to 150mA Output Current (each LDO).
- Low Quiescent Current : 50 μ A at single output.
- Low Dropout : 145mV at 100mA load current and 3.3V output voltage.
- High PSRR : 60dB at 1kHz.
- Independent Shutdown Controls.
- Current Limit and Thermal Protection.
- Tiny SOT-23-6, TSOT-23-6 and DFN6L 2x2 Package.

APPLICATIONS

- Cellular Phones.
- PDAs.
- Digital Still Cameras.
- Portable Consumer Equipments.

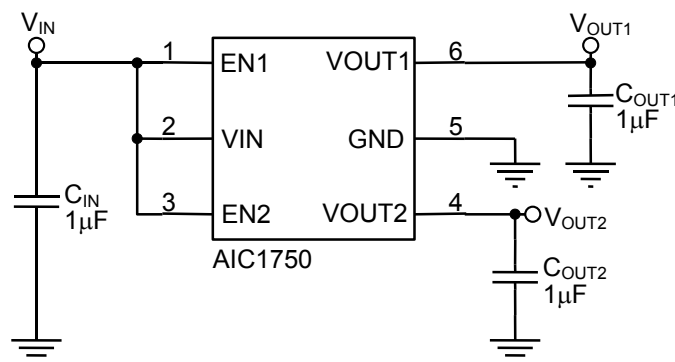
DESCRIPTION

The AIC1750 is a dual output linear regulator in a tiny SOT-23-6, TSOT-23-6 and DFN6L 2X2 package. It is optimized for low ESR ceramic capacitors operation and up to 150mA continuous current on each output.

The AIC1750 offers high precision output voltage of $\pm 2\%$. At 100mA load current, a 145mV dropout is performed when output voltage is equal to 3.3V. The quality of low quiescent current and low dropout voltage makes this device ideal for battery power applications. The high ripple rejection and low noise of the AIC1750 provide enhanced performances for critical applications such as cellular phones, and PDAs.

The AIC1750 includes current limit and thermal shutdown protection. Each of the output is controlled independently.

TYPICAL APPLICATION CIRCUIT



ORDERING INFORMATION

AIC1750-XXXXXXXX

 PACKING TYPE
 TR: TAPE & REEL

 PACKAGE TYPE
 GT: SOT-23-6
 GL: SOT-23-6
 KT: TSOT-23-6
 KL: TSOT-23-6
 DA: DFN6L 2X2

 P: LEAD FREE COMMERCIAL
 G: GREEN PACKAGE
 (Only for DFN6L 2X2)

OUTPUT2 VOLTAGE:

	VOUT2
A	1.1V
:	:
:	:
W	3.3V

OUTPUT1 VOLTAGE:

	VOUT1
A	1.1V
:	:
:	:
W	3.3V

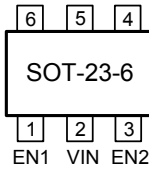
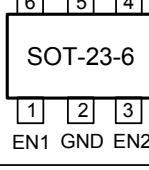
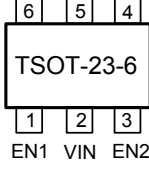
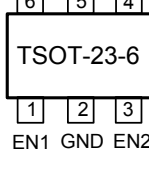
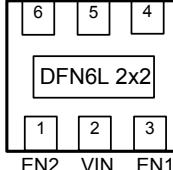
* LDO Output1 Voltage and Output2 Voltage with every 0.1V a step.

Example: AIC1750-OHPGTTR

- Vout1 = 2.5V, Vout2 = 1.8V, with GT type pin configuration in SOT-23-6 lead free package and TAPE & REEL packing.

AIC1750-CAPGLTR

- Vout1 = 1.3V, Vout2 = 1.1V, with GL type pin configuration in SOT-23-6 lead free package and TAPE & REEL packing.

PACKAGE TYPE	PIN CONFIGURATION
GT (SOT-23-6)	FRONT VIEW VOUT1 GND VOUT2 
GL (SOT-23-6)	FRONT VIEW VOUT1 VIN VOUT2 
KT (TSOT-23-6)	FRONT VIEW VOUT1 GND VOUT2 
KL (TSOT-23-6)	FRONT VIEW VOUT1 VIN VOUT2 
DA (DFN6L 2x2)	FRONT VIEW VOUT2 VOUT1 GND 

•SOT-23-6 Marking

Part No.	Marking	Output Voltage
AIC1750-XXPGT	BVXXP	1st X -> Vout1, 2nd X -> Vout2 X=A,B,C...,W (A=1.1V, B=1.2V,C=1.3V,D=1.4V.....,W=3.3V, 0.1V a step)
AIC1750-XXPGL	BWXXP	1st X -> Vout1, 2nd X -> Vout2 X=A,B,C...,W (A=1.1V, B=1.2V,C=1.3V,D=1.4V.....,W=3.3V, 0.1V a step)

•TSOT-23-6 Marking

Part No.	Marking	Output Voltage
AIC1750-XXPKT	BYXXP	1st X -> Vout1, 2nd X -> Vout2 X=A,B,C...,W (A=1.1V, B=1.2V,C=1.3V,D=1.4V.....,W=3.3V, 0.1V a step)
AIC1750-XXPKL	BZXXP	1st X -> Vout1, 2nd X -> Vout2 X=A,B,C...,W (A=1.1V, B=1.2V,C=1.3V,D=1.4V.....,W=3.3V, 0.1V a step)

•DFN6L 2X2 Marking

Part No.	Marking	Output Voltage
AIC1750-XXPDA	CYXXP	1st X -> Vout1, 2nd X -> Vout2 X=A,B,C...,W (A=1.1V, B=1.2V,C=1.3V,D=1.4V.....,W=3.3V, 0.1V a step)
AIC1750-XXGDA	CYXXG	1st X -> Vout1, 2nd X -> Vout2 X=A,B,C...,W (A=1.1V, B=1.2V,C=1.3V,D=1.4V.....,W=3.3V, 0.1V a step)

■ ABSOLUTE MAXIMUM RATINGS

Input Voltage	6V
EN Pin Voltage.....	6V
Operating Ambient Temperature Range T_A	-40°C~85°C
Operating Maximum Junction Temperature T_J	125°C
Storage Temperature Range T_{STG}	-65°C~150°C
Lead Temperature (Soldering 10 Sec.).....	260°C
Thermal Resistance Junction to Case	
SOT-23-6	115°C/W
TSOT-23-6	115°C/W
DFN6L 2X2	30°C/W
Thermal Resistance Junction to Ambient	
SOT-23-6	250°C/W
TSOT-23-6	250°C/W
DFN6L 2X2	165°C/W

(Assume no Ambient Airflow, no Heatsink)

Absolute Maximum Ratings are those values beyond which the life of a device may be impaired.

ELECTRICAL CHARACTERISTICS
($V_{IN} = V_{OUT} + 1V$, $V_{EN1}=V_{EN2}= V_{IN}$, $T_J=25^{\circ}C$, unless otherwise specified) (Note 1)

PARAMETER	TEST CONDITIONS	SYMBOL	MIN.	TYP.	MAX.	UNIT	
Input Voltage <small>(Note 2)</small>		V_{IN}	2.0		5.5	V	
Output Voltage Tolerance	$I_{OUT} = 30mA$	V_{OUT}	-2		2	%	
Continuous Output Current		I_{OUT}	150			mA	
Quiescent Current	$I_{OUT1} = 0mA$ & $V_{EN2} = 0V$ or $I_{OUT2} = 0mA$ & $V_{EN1} = 0V$	I_Q		50	75	μA	
GND Pin Current	$I_{OUT1} = 150mA$ & $V_{EN2} = 0V$ or $I_{OUT2} = 150mA$ & $V_{EN1} = 0V$	I_{GND}		55	75	μA	
Standby Current	$V_{EN1}=V_{EN2}= 0$	I_{STBY}			0.1	μA	
Output Current Limit	$V_{OUT} = GND$	I_{IL}	180	350	500	mA	
Dropout Voltage (1)	$I_{OUT} = 30 mA$	$V_{OUT}=1.2V$	V_{DROP1}		550	750	mV
	$I_{OUT} = 100 mA$				640	800	
	$I_{OUT} = 150 mA$				800	1000	
Dropout Voltage (2)	$I_{OUT} = 30 mA$	$V_{OUT}=1.8V$	V_{DROP2}		85	150	mV
	$I_{OUT} = 100 mA$				280	400	
	$I_{OUT} = 150 mA$				410	600	
Dropout Voltage (3)	$I_{OUT} = 30 mA$	$V_{OUT}=3.3V$	V_{DROP3}		45	60	mV
	$I_{OUT} = 100 mA$				145	200	
	$I_{OUT} = 150 mA$				240	300	
Line Regulation	$V_{IN} = V_{OUT} + 1V$ to 5.5V	ΔV_{LIR}			10	mV	
Load Regulation	$I_{OUT} = 1mA$ to 150mA	ΔV_{LOR}		15	60	mV	
Ripple Rejection	f=1kHz, Ripple=0.5Vp-p,	PSRR		60		dB	
Temperature Coefficient		TC		50		ppm/ $^{\circ}C$	
Thermal Shutdown Temperature	$V_{IN} = V_{OUT} + 1V$			150		$^{\circ}C$	
Thermal Shutdown Hysteresis				20		$^{\circ}C$	
EN Pin SPECIFICATIONS							
EN Pin Current	$V_{EN1} = V_{EN2} = V_{IN}$	I_{EN}		0.1	1	μA	
EN Input Threshold	Output ON	V_{ENH}	1.6			V	
	Output OFF	V_{ENL}			0.25		

Note 1: Specifications are production tested at $T_A=25^{\circ}C$. Specifications over the $-40^{\circ}C$ to $85^{\circ}C$ operating temperature range are assured by design, characterization and correlation with Statistical Quality Controls (SQC).

Note 2: Choose the maximum value of $(V_{OUT}+V_{DROP})$ or 2.0V as $V_{IN(min)}$.

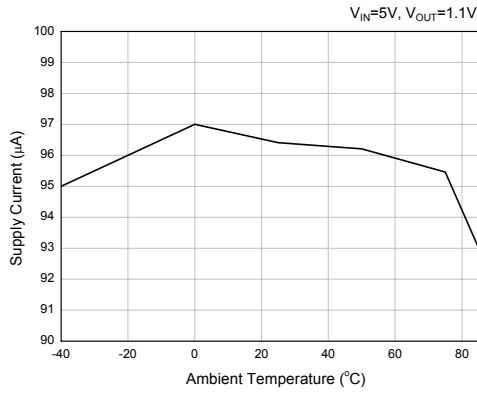
TYPICAL PERFORMANCE CHARACTERISTICS


Fig. 1 Supply Current vs. Temperature

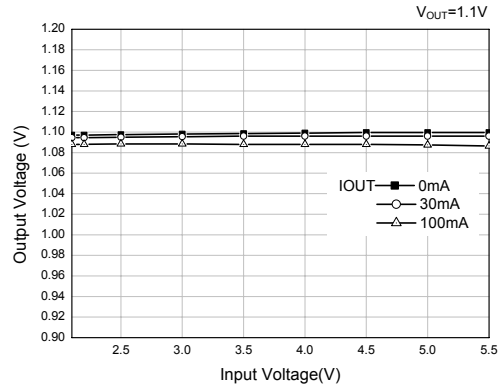


Fig. 2 Output Voltage vs. Input Voltage

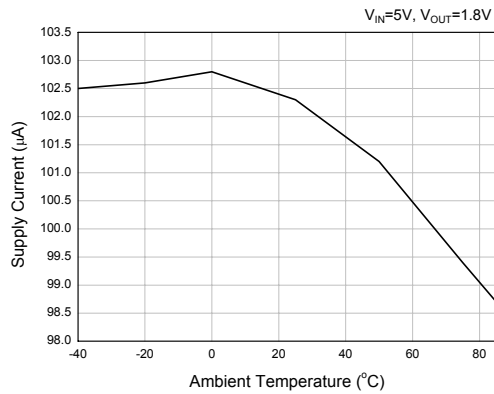


Fig. 3 Supply Current vs. Temperature

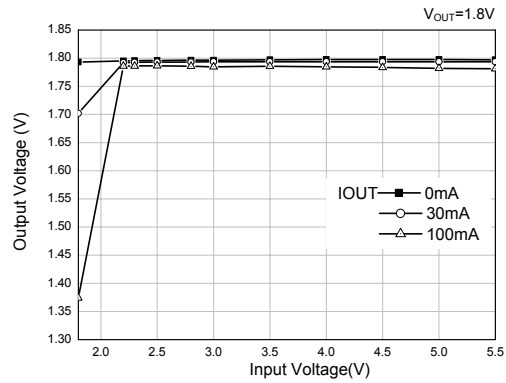


Fig. 4 Output Voltage vs. Input Voltage

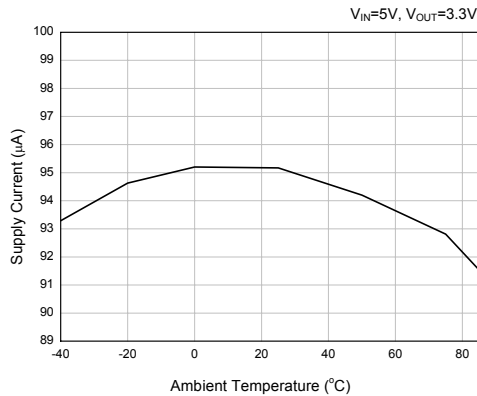


Fig. 5 Supply Current vs. Temperature

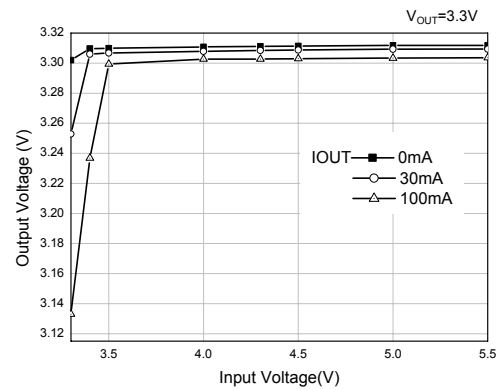


Fig. 6 Output Voltage vs. Input Voltage

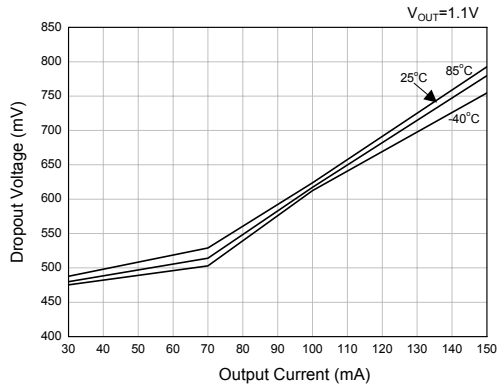


Fig. 7 Dropout Voltage vs. Output Current

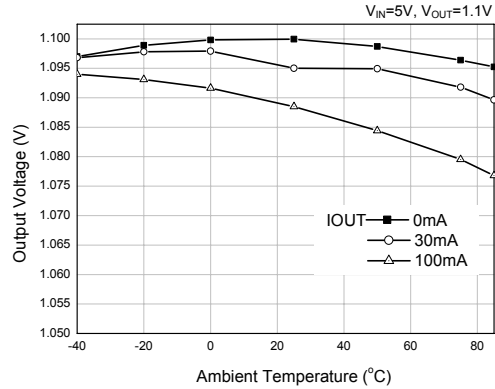


Fig. 8 Output Voltage vs. Temperature

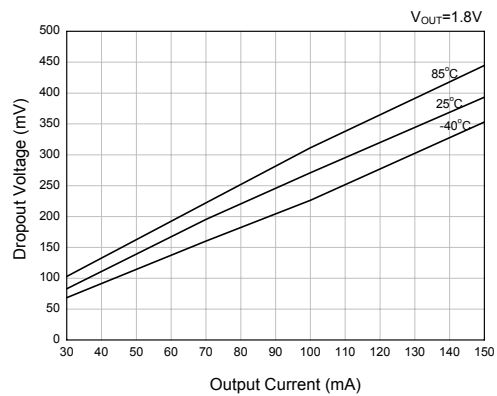


Fig. 9 Dropout Voltage vs. Output Current

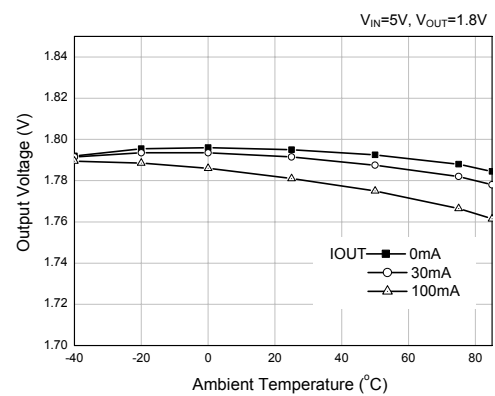


Fig. 10 Output Voltage vs. Temperature

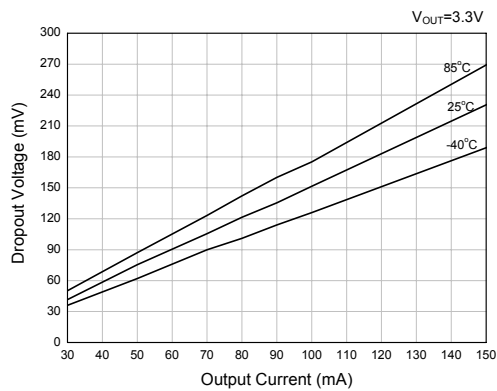


Fig. 11 Dropout Voltage vs. Output Current

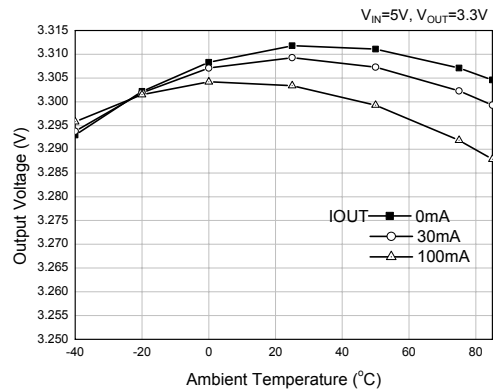
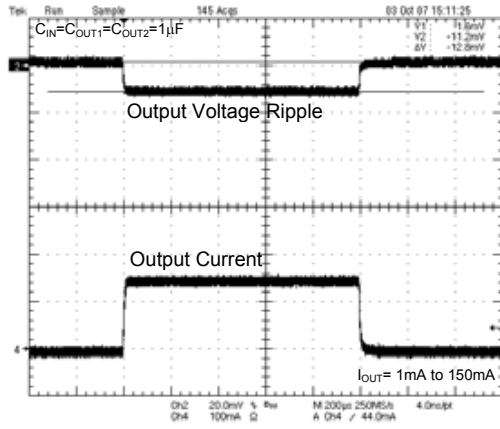
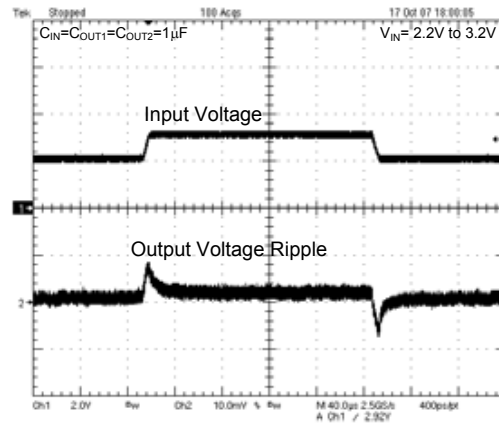
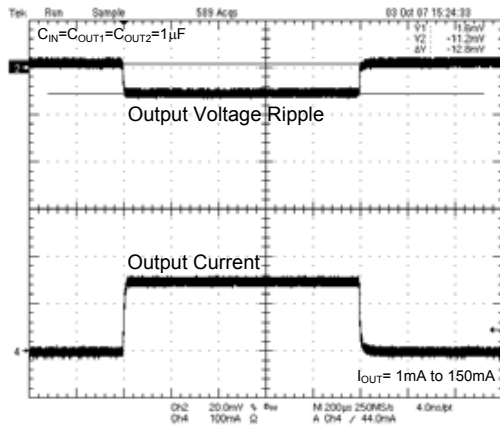
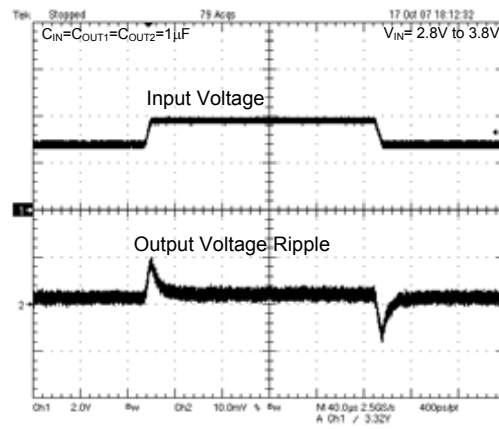
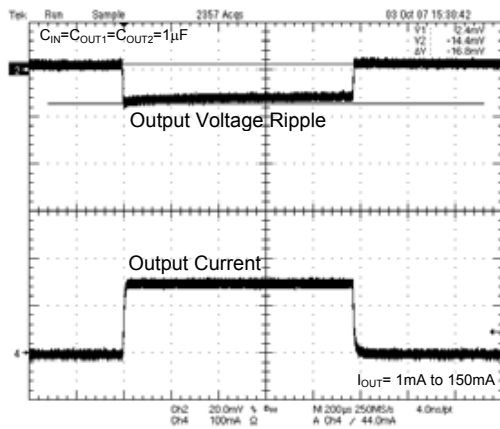
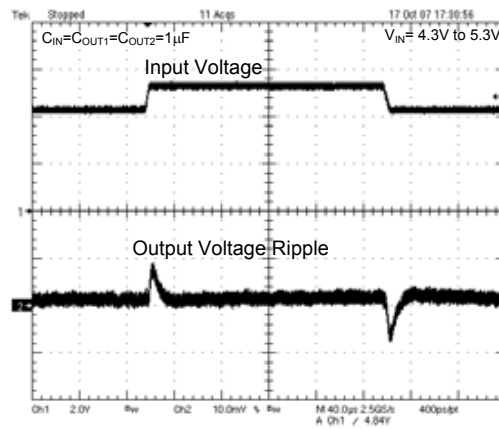


Fig. 12 Output Voltage vs. Temperature


 Fig. 13 Load Transient Response at $V_{IN}=5.5V$, $V_{OUT}=1.1V$

 Fig. 14 Line Transient Response at $V_{OUT}=1.1V$, $I_{OUT}=150mA$

 Fig. 15 Load Transient Response at $V_{IN}=5.5V$, $V_{OUT}=1.8V$

 Fig. 16 Line Transient Response at $V_{OUT}=1.8V$, $I_{OUT}=150mA$

 Fig. 17 Load Transient Response at $V_{IN}=5.5V$, $V_{OUT}=3.3V$

 Fig. 18 Line Transient Response at $V_{OUT}=3.3V$, $I_{OUT}=150mA$

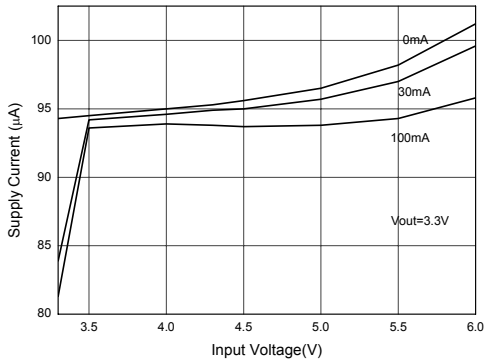


Fig. 19 Supply Current vs. Input Voltage

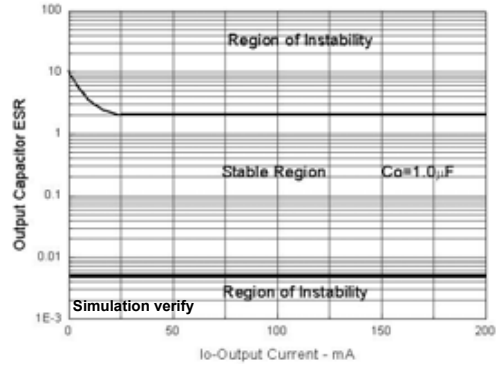


Fig. 20 Region of Stable C_{OUT} ESR vs. Load Current

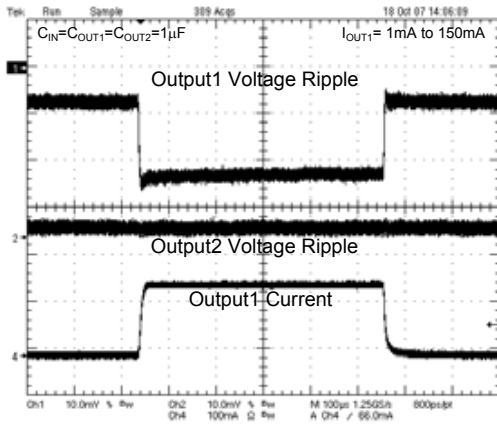


Fig. 21 Cross talk at V_{IN}=3.8V, V_{OUT1}=1.8V, V_{OUT2}=2.8V, I_{OUT2}=150mA

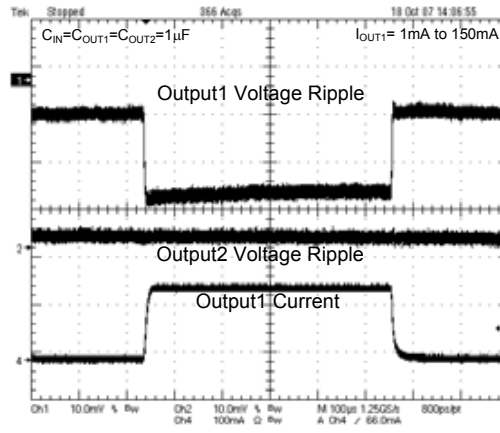
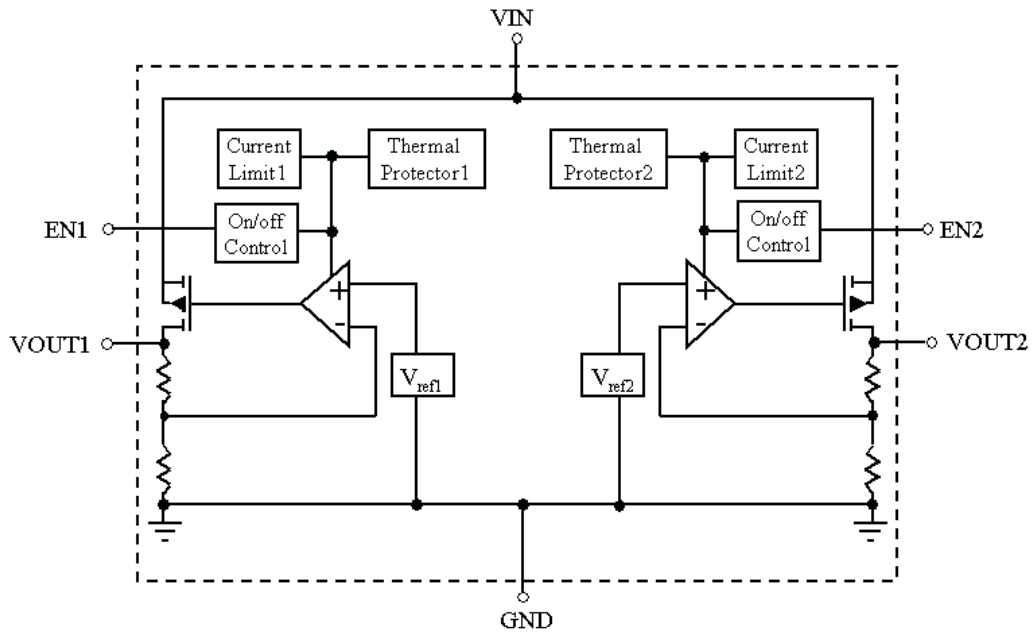


Fig. 22 Cross talk at V_{IN}=5.5V, V_{OUT1}=1.8V, V_{OUT2}=2.8V, I_{OUT2}=150mA

■ BLOCK DIAGRAM

■ PIN DESCRIPTION

- VIN PIN - Power input.
- GND PIN - Ground.
- EN1 PIN - Output 1 ON/OFF controller. This pin isn't allowed to float.
- EN2 PIN - Output 2 ON/OFF controller. This pin isn't allowed to float.
- VOUT1 PIN - Output 1.
- VOUT2 PIN - Output 2.

■ APPLICATION INFORMATION

The AIC1750 is a low-dropout, low quiescent-current, dual-output linear regulator for battery power applications. These parts are available with preset output voltages ranging from 1.1V to 3.3V, and the parts can supply loads up to 150mA.

SHUTDOWN

The AIC1750 has two independent shutdown control inputs (EN1 and EN2). By connecting EN1 pin to ground, output1 can be shut down. By connecting EN2 pin to ground, output2 can be shut down. By connecting both of EN1 pin and EN2 pin to ground, the AIC1750 can be shut down to reduce the supply current to 0.1μA.

CURRENT LIMIT

The AIC1750 includes two independent current limiters, which monitor and control the maximum output current. If the output is overloaded or shorted to ground, this can protect the device from being damaged.

THERMAL PROTECTION

The AIC1750 includes two independent thermal-limiting circuits, which are designed to protect the device against overload condition. When the junction temperature exceeds $T_J=150^{\circ}\text{C}$, the thermal-limiting circuit turns off the pass transistor and allows the IC to cool. For continuous load condition, maximum rating of junction temperature must not be exceeded.

INPUT-OUTPUT CAPACITORS

Linear regulators require input and output capacitors to maintain stability. Input capacitor at 1μF with a 1μF ceramic output capacitor for each regulator is

recommended. To avoid oscillation, it is recommended to follow the figure of “Region of Stable C_{OUT} ESR vs. Load Current” to choose proper capacitor specifications.

When choosing the input and output ceramic capacitors, X5R and X7R types are recommended because they retain their capacitance over wider ranges of voltage and temperature than other types.

POWER DISSIPATION

The maximum power dissipation of AIC1750 depends on the thermal resistance of its case and circuit board, the temperature difference between the die junction and ambient air, and the rate of airflow. The rate of temperature rise is greatly affected by the mounting pad configuration on the PCB, the board material, and the ambient temperature. When the IC mounting with good thermal conductivity is used, the junction temperature will be low even when large power dissipation applies.

The power dissipation across the device is

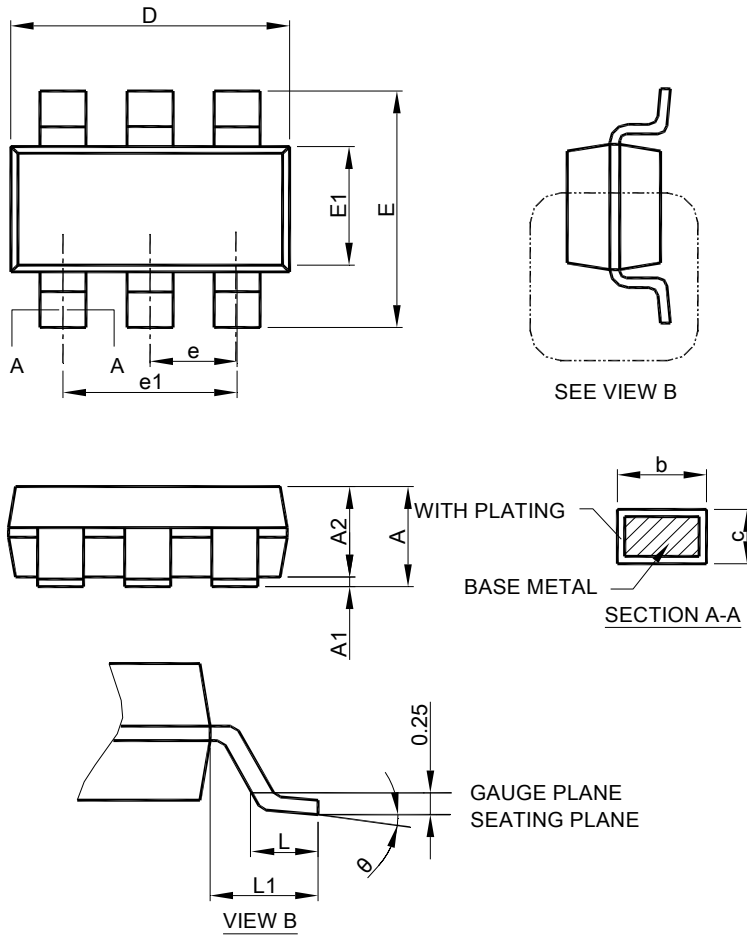
$$P = I_{\text{OUT1}} (V_{\text{IN}} - V_{\text{OUT1}}) + I_{\text{OUT2}} (V_{\text{IN}} - V_{\text{OUT2}})$$

The maximum power dissipation is:

$$P_{\text{MAX}} = \frac{(T_{\text{J-max}} - T_{\text{A}})}{R\theta_{\text{JA}}}$$

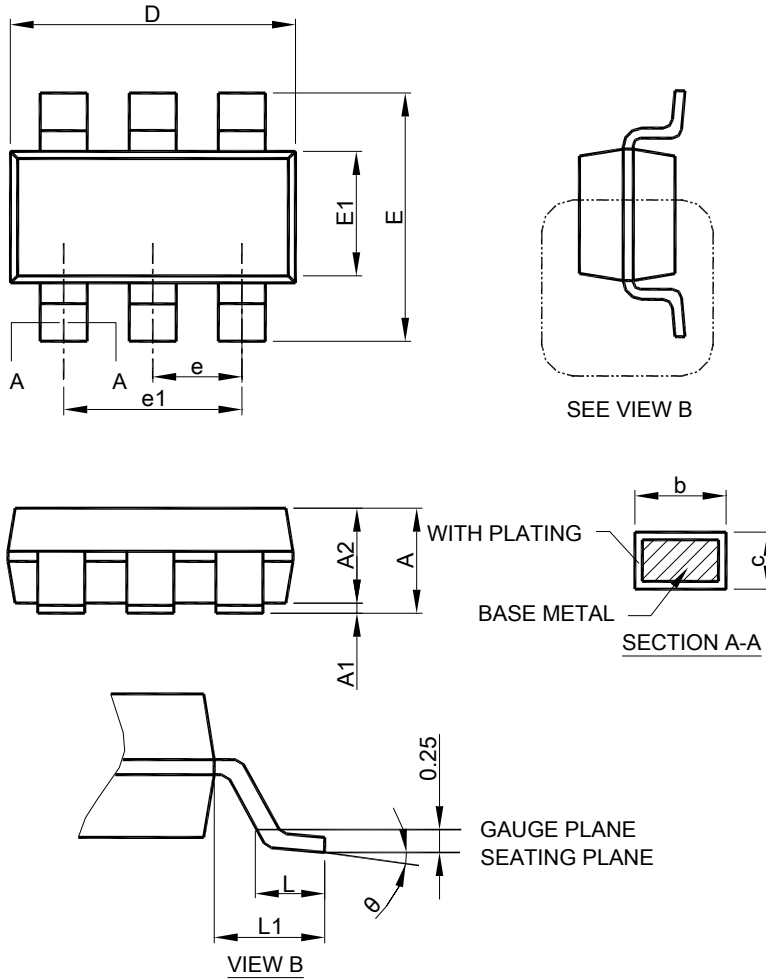
Where $T_{\text{J-max}}$ is the maximum allowable junction temperature (125°C), and T_{A} is the ambient temperature suitable in application.

As a general rule, the lower temperature is, the better reliability of the device is. So the PCB mounting pad should provide maximum thermal conductivity to maintain low device temperature.

PHYSICAL DIMENSIONS
SOT-23-6


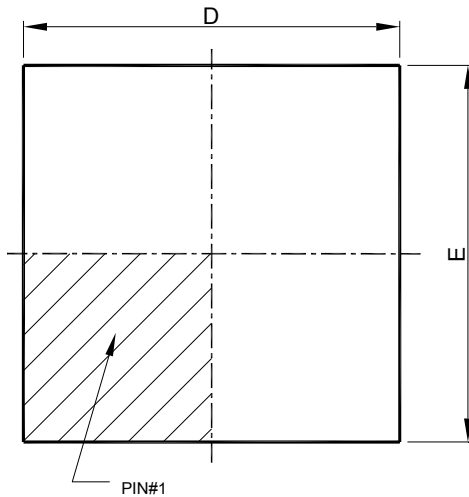
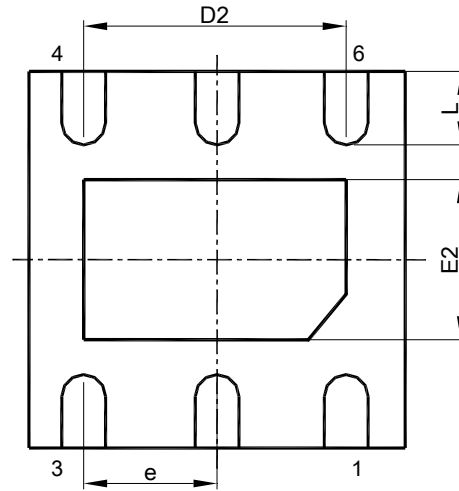
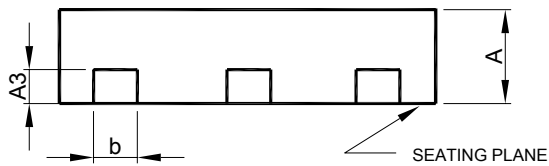
- Note :
1. Refer to JEDEC MO-178AB.
 2. Dimension "D" does not include mold flash, protrusions or gate burrs. Mold flash, protrusion or gate burrs shall not exceed 10 mil per side.
 3. Dimension "E1" does not include inter-lead flash or protrusions.
 4. Controlling dimension is millimeter, converted inch dimensions are not necessarily exact.

SYMBOL	SOT-23-6	
	MILLIMETERS	
	MIN.	MAX.
A	0.95	1.45
A1	0.05	0.15
A2	0.90	1.30
b	0.30	0.50
c	0.08	0.22
D	2.80	3.00
E	2.60	3.00
E1	1.50	1.70
e	0.95 BSC	
e1	1.90 BSC	
L	0.30	0.60
L1	0.42 REF	
θ	0°	8°

● TSOT-23-6


- Note : 1. Refer to JEDEC MO-193AA.
 2. Dimension "D" does not include mold flash, protrusions or gate burrs. Mold flash, protrusion or gate burrs shall not exceed 6 mil per side.
 3. Dimension "E1" does not include inter-lead flash or protrusions.
 4. Controlling dimension is millimeter, converted inch dimensions are not necessarily exact.

SYMBOL	TSOT-23-6	
	MILLIMETERS	
	MIN.	MAX.
A	-	1.00
A1	0	0.10
A2	0.70	0.90
b	0.30	0.50
c	0.08	0.22
D	2.80	3.00
E	2.60	3.00
E1	1.50	1.70
e	0.95 BSC	
e1	1.90 BSC	
L	0.30	0.60
L1	0.60 REF	
θ	0°	8°

● DFN6L 2X2

TOP VIEW

BOTTOM VIEW

SIDE VIEW

SYMBOL	DFN 6L-2x2x0.75-0.65mm	
	MILLIMETERS	
	MIN.	MAX.
A	0.70	0.80
A3	0.20 BSC	
b	0.25	0.35
D	2.00 BSC	
D2	1.35	1.45
E	2.00 BSC	
E2	0.55	0.65
e	0.65 BSC	
L	0.25	0.35

- Note : 1. DIMENSION AND TOLERANCING CONFORM TO ASME Y14.5M-1994.
 2. CONTROLLING DIMENSIONS : MILLIMETER , CONVERTED INCH DIMENSION ARE NOT NECESSARILY EXACT.
 3. DIMENSION b APPLIES TO METALLIZED TERMINAL AND IS MEASURED BETWEEN 0.10 AND 0.25 mm FROM TERMINAL TIP.

Note:

Information provided by AIC is believed to be accurate and reliable. However, we cannot assume responsibility for use of any circuitry other than circuitry entirely embodied in an AIC product; nor for any infringement of patents or other rights of third parties that may result from its use. We reserve the right to change the circuitry and specifications without notice.

Life Support Policy: AIC does not authorize any AIC product for use in life support devices and/or systems. Life support devices or systems are devices or systems which, (i) are intended for surgical implant into the body or (ii) support or sustain life, and whose failure to perform, when properly used in accordance with instructions for use provided in the labeling, can be reasonably expected to result in a significant injury to the user.