

# MC68HC908LD64

Data Sheet

**M68HC08  
Microcontrollers**

MC68HC908LD64  
Rev. 3.0  
07/2004

*freescale.com*





# MC68HC908LD64

## Data Sheet

---

---

To provide the most up-to-date information, the revision of our documents on the World Wide Web will be the most current. Your printed copy may be an earlier revision. To verify you have the latest information available, refer to:

<http://www.freescale.com>

The following revision history table summarizes changes contained in this document. For your convenience, the page number designators have been linked to the appropriate location.

# Revision History

## Revision History

Date	Revision Level	Description	Page Number(s)
July 2004	3	<b>Figure 13-2 . ADC Block Diagram</b> — Removed incorrect ADICLK input to clock generator in block diagram.	179
		<b>18.7.1 OSD Control Register (OSDCR)</b> — Corrected HALFCLK bit definitions.	278
		<b>18.7.2 OSD Status Register (OSDSR)</b> — Corrected WRDY bit description.	278
		<b>18.7.3 OSD Data Registers (OSDDRH:OSDDRL)</b> — Corrected OSDD[15:0] bits description.	279
		<b>18.8.3.5 Frame Control Registers</b> — Corrected OSD_EN bit location.	288
		<b>Section 11. Timer Interface Module (TIM)</b> — Corrected timer discrepancies throughout.	149
		<b>Section 16. DDC12AB Interface</b> — Changed the prefix "D" to "DDC" in DDC12AB register name abbreviations throughout.	235

## List of Sections

Section 1. General Description .....	31
Section 2. Memory Map .....	41
Section 3. Random-Access Memory (RAM) .....	61
Section 4. FLASH Memory .....	63
Section 5. Configuration Register (CONFIG) .....	75
Section 6. Central Processor Unit (CPU) .....	77
Section 7. Oscillator (OSC) .....	95
Section 8. Clock Generator Module (CGM).....	99
Section 9. System Integration Module (SIM) .....	113
Section 10. Monitor ROM (MON) .....	137
Section 11. Timer Interface Module (TIM).....	149
Section 12. Pulse Width Modulator (PWM).....	171
Section 13. Analog-to-Digital Converter (ADC) .....	177
Section 14. Universal Serial Bus Module (USB).....	187
Section 15. Multi-Master IIC Interface (MMIIC) .....	221
Section 16. DDC12AB Interface .....	235
Section 17. Sync Processor.....	251
Section 18. On-Screen Display (OSD).....	271
Section 19. Input/Output (I/O) Ports .....	293
Section 20. External Interrupt (IRQ) .....	315
Section 21. Keyboard Interrupt Module (KBI).....	321
Section 22. Computer Operating Properly (COP) .....	329
Section 23. Break Module (BRK) .....	335
Section 24. Electrical Specifications.....	343
Section 25. Mechanical Specifications .....	357
Section 26. Ordering Information .....	359

# List of Sections

## Table of Contents

### Section 1. General Description

1.1	Contents . . . . .	31
1.2	Introduction . . . . .	31
1.3	Features . . . . .	32
1.4	MCU Block Diagram . . . . .	34
1.5	Pin Assignments . . . . .	36
1.6	Pin Functions . . . . .	37

### Section 2. Memory Map

2.1	Contents . . . . .	41
2.2	Introduction . . . . .	41
2.3	Unimplemented Memory Locations . . . . .	41
2.4	Reserved Memory Locations . . . . .	42
2.5	Input/Output (I/O) Section . . . . .	42

### Section 3. Random-Access Memory (RAM)

3.1	Contents . . . . .	61
3.2	Introduction . . . . .	61
3.3	Functional Description . . . . .	61

### Section 4. FLASH Memory

4.1	Contents . . . . .	63
4.2	Introduction . . . . .	64

4.3	Functional Description . . . . .	64
4.4	FLASH Control Registers . . . . .	66
4.4.1	OSD FLASH Even High Byte Write Buffer (OSDEHBUF) . .	67
4.5	FLASH Block Erase Operation . . . . .	68
4.6	FLASH Mass Erase Operation . . . . .	69
4.7	FLASH Program Operation . . . . .	70
4.8	FLASH Block Protection . . . . .	72
4.8.1	FLASH Block Protect Registers . . . . .	72

## **Section 5. Configuration Register (CONFIG)**

5.1	Contents . . . . .	75
5.2	Introduction . . . . .	75
5.3	Functional Description . . . . .	75
5.4	Configuration Register . . . . .	76

## **Section 6. Central Processor Unit (CPU)**

6.1	Contents . . . . .	77
6.2	Introduction . . . . .	78
6.3	Features . . . . .	78
6.4	CPU Registers . . . . .	79
6.4.1	Accumulator . . . . .	79
6.4.2	Index Register . . . . .	80
6.4.3	Stack Pointer . . . . .	80
6.4.4	Program Counter . . . . .	81
6.4.5	Condition Code Register . . . . .	82
6.5	Arithmetic/Logic Unit (ALU) . . . . .	84
6.6	Low-Power Modes . . . . .	84
6.6.1	Wait Mode . . . . .	84
6.6.2	Stop Mode . . . . .	85
6.7	CPU During Break Interrupts . . . . .	85



6.8	Instruction Set Summary .....	85
6.9	Opcode Map .....	85

## Section 7. Oscillator (OSC)

7.1	Contents .....	95
7.2	Introduction .....	95
7.3	Oscillator External Connections .....	96
7.4	I/O Signals .....	97
7.4.1	Crystal Amplifier Input Pin (OSC1) .....	97
7.4.2	Crystal Amplifier Output Pin (OSC2) .....	97
7.4.3	Oscillator Enable Signal (SIMOSCEN) .....	97
7.4.4	External Clock Source (OSCXCLK) .....	97
7.4.5	Oscillator Out (OSCOUT) .....	97
7.5	Low Power Modes .....	98
7.5.1	Wait Mode .....	98
7.5.2	Stop Mode .....	98
7.6	Oscillator During Break Mode .....	98

## Section 8. Clock Generator Module (CGM)

8.1	Contents .....	99
8.2	Introduction .....	100
8.3	Features .....	100
8.4	Functional Description .....	100
8.4.1	Crystal Oscillator Circuit .....	103
8.5	CGM I/O Signals .....	103
8.5.1	External Filter Capacitor Pin (CGMXFC) .....	103
8.5.2	PLL Analog Power Pin (VDDA) .....	103
8.5.3	PLL Analog Ground Pin (VSSA) .....	103
8.5.4	Crystal Output Frequency Signal (OSCXCLK) .....	104
8.5.5	Crystal Reference Frequency Signal (OSCRCLK) .....	104
8.5.6	CGM Base Clock Output (DCLK1) .....	104
8.5.7	CGM CPU Interrupt (CGMINT) .....	104

8.6	CGM I/O Registers	104
8.6.1	PLL Control Register (PCTL)	105
8.6.2	PLL Bandwidth Control Register (PBWC)	106
8.6.3	PLL Programming Register (PPG)	108
8.6.4	H & V Sync Output Control Register (HVOOCR)	110
8.7	Interrupts	111
8.8	Low-Power Modes	111
8.8.1	Wait Mode	111
8.8.2	Stop Mode	112
8.9	CGM During Break Interrupts	112

## Section 9. System Integration Module (SIM)

9.1	Contents	113
9.2	Introduction	114
9.3	SIM Bus Clock Control and Generation	117
9.3.1	Bus Timing	117
9.3.2	Clock Start-Up from POR	117
9.3.3	Clocks in Stop Mode and Wait Mode	117
9.4	Reset and System Initialization	118
9.4.1	External Pin Reset	118
9.4.2	Active Resets from Internal Sources	119
9.4.2.1	Power-On Reset	120
9.4.2.2	Computer Operating Properly (COP) Reset	121
9.4.2.3	Low-Voltage Inhibit Reset	121
9.4.2.4	Illegal Opcode Reset	121
9.4.2.5	Illegal Address Reset	122
9.5	SIM Counter	122
9.5.1	SIM Counter During Power-On Reset	122
9.5.2	SIM Counter During Stop Mode Recovery	122
9.5.3	SIM Counter and Reset States	123
9.6	Exception Control	123
9.6.1	Interrupts	124
9.6.1.1	Hardware Interrupts	126

9.6.1.2	SWI Instruction . . . . .	127
9.6.2	Interrupt Status Registers . . . . .	127
9.6.2.1	Interrupt Status Register 1 . . . . .	129
9.6.2.2	Interrupt Status Register 2 . . . . .	129
9.6.3	Reset . . . . .	130
9.6.4	Break Interrupts . . . . .	130
9.6.5	Status Flag Protection in Break Mode . . . . .	130
9.7	Low-Power Modes . . . . .	131
9.7.1	Wait Mode . . . . .	131
9.7.2	Stop Mode . . . . .	132
9.8	SIM Registers . . . . .	134
9.8.1	SIM Break Status Register (SBSR) . . . . .	134
9.8.2	SIM Reset Status Register (SRSR) . . . . .	135
9.8.3	SIM Break Flag Control Register (SBFCR) . . . . .	136

## Section 10. Monitor ROM (MON)

10.1	Contents . . . . .	137
10.2	Introduction . . . . .	137
10.3	Features . . . . .	138
10.4	Functional Description . . . . .	138
10.4.1	Entering Monitor Mode . . . . .	140
10.4.2	Data Format . . . . .	142
10.4.3	Echoing . . . . .	143
10.4.4	Break Signal . . . . .	143
10.4.5	Commands . . . . .	144
10.4.6	Baud Rate . . . . .	147

## Section 11. Timer Interface Module (TIM)

11.1	Contents . . . . .	149
11.2	Introduction . . . . .	150
11.3	Features . . . . .	150
11.4	Pin Name Conventions . . . . .	150

11.5	Functional Description	151
11.5.1	TIM Counter Prescaler	153
11.5.2	Input Capture	153
11.5.3	Output Compare	153
11.5.3.1	Unbuffered Output Compare	154
11.5.3.2	Buffered Output Compare	155
11.5.4	Pulse Width Modulation (PWM)	155
11.5.4.1	Unbuffered PWM Signal Generation	156
11.5.4.2	Buffered PWM Signal Generation	157
11.5.4.3	PWM Initialization	158
11.6	Interrupts	159
11.7	Low-Power Modes	159
11.7.1	Wait Mode	159
11.7.2	Stop Mode	160
11.8	TIM During Break Interrupts	160
11.9	I/O Signals	160
11.10	I/O Registers	161
11.10.1	TIM Status and Control Register (TSC)	161
11.10.2	TIM Counter Registers (TCNTH:TCNTL)	163
11.10.3	TIM Counter Modulo Registers (TMODH:TMODL)	164
11.10.4	TIM Channel Status and Control Registers (TSC0:TSC1)	165
11.10.5	TIM Channel Registers (TCH0H/L:TCH1H/L)	168

## Section 12. Pulse Width Modulator (PWM)

12.1	Contents	171
12.2	Introduction	171
12.3	Functional Description	171
12.4	PWM Registers	173
12.4.1	PWM Data Registers 0 to 7 (0PWM–7PWM)	173
12.4.2	PWM Control Register (PWMCR)	174

## Section 13. Analog-to-Digital Converter (ADC)

13.1	Contents	177
13.2	Introduction	178
13.3	Features	178
13.4	Functional Description	179
13.4.1	ADC Port I/O Pins	180
13.4.2	Voltage Conversion	180
13.4.3	Conversion Time	180
13.4.4	Continuous Conversion	181
13.4.5	Accuracy and Precision	181
13.5	Interrupts	181
13.6	Low-Power Modes	181
13.6.1	Wait Mode	181
13.6.2	Stop Mode	182
13.7	I/O Signals	182
13.7.1	ADC Analog Power Pin (VDDA)	182
13.7.2	ADC Analog Ground Pin (VSSA)	182
13.7.3	ADC Voltage Reference High Pin (VRH)	182
13.7.4	ADC Voltage Reference Low Pin (VRL)	182
13.7.5	ADC Voltage In (ADCVIN)	182
13.8	I/O Registers	183
13.8.1	ADC Status and Control Register	183
13.8.2	ADC Data Register	185
13.8.3	ADC Input Clock Register	185

## Section 14. Universal Serial Bus Module (USB)

14.1	Contents	187
14.2	Introduction	188
14.3	Features	188
14.4	I/O Pins	189
14.5	Overview	192

## Table of Contents

14.6	Hub Function I/O Registers	194
14.6.1	USB Hub Root Port Control Register (HRPCR)	194
14.6.2	USB Hub Downstream Port Control Registers (HDP1CR–HDP4CR)	195
14.6.3	USB SIE Timing Interrupt Register (SIETIR)	198
14.6.4	USB SIE Timing Status Register (SIETSR)	200
14.6.5	USB Hub Address Register (HADDR)	202
14.6.6	USB Hub Interrupt Register 0 (HIR0)	203
14.6.7	USB Hub Control Register 0 (HCR0)	205
14.6.8	USB Hub Endpoint 1 Control and Data Register (HCDR)	206
14.6.9	USB Hub Status Register (HSR)	208
14.6.10	USB Hub Endpoint 0 Data Registers (HE0D0–HE0D7)	209
14.7	Embedded Device Function I/O Registers	209
14.7.1	USB Embedded Device Address Register (DADDR)	210
14.7.2	USB Embedded Device Interrupt Register 0 (DIR0)	210
14.7.3	USB Embedded Device Interrupt Register 1 (DIR1)	212
14.7.4	USB Embedded Device Control Register 0 (DCR0)	213
14.7.5	USB Embedded Device Control Register 1 (DCR1)	215
14.7.6	USB Embedded Device Control Register 2 (DCR2)	216
14.7.7	USB Embedded Device Status Register (DSR)	217
14.7.8	USB Embedded Device Endpoint 0 Data Registers (DE0D0–DE0D7)	219
14.7.9	USB Embedded Device Endpoint 1/2 Data Registers (DE1D0–DE1D7)	219

## Section 15. Multi-Master IIC Interface (MMIIC)

15.1	Contents	221
15.2	Introduction	221
15.3	Features	222
15.4	I/O Pins	222
15.5	Multi-Master IIC Registers	223
15.5.1	Multi-Master IIC Address Register (MMADR)	224
15.5.2	Multi-Master IIC Control Register (MMCR)	225
15.5.3	Multi-Master IIC Master Control Register (MIMCR)	226
15.5.4	Multi-Master IIC Status Register (MMSR)	228

15.5.5	Multi-Master IIC Data Transmit Register (MMDTR) . . . . .	230
15.5.6	Multi-Master IIC Data Receive Register (MMDRR) . . . . .	231
15.6	Programming Considerations . . . . .	232

## Section 16. DDC12AB Interface

16.1	Contents . . . . .	235
16.2	Introduction . . . . .	235
16.3	Features . . . . .	236
16.4	I/O Pins . . . . .	236
16.5	DDC Protocols . . . . .	238
16.6	DDC Registers . . . . .	238
16.6.1	DDC Address Register (DDCADR) . . . . .	238
16.6.2	DDC2 Address Register (DDC2ADR) . . . . .	239
16.6.3	DDC Control Register (DDCCR) . . . . .	240
16.6.4	DDC Master Control Register (DDCMCR) . . . . .	241
16.6.5	DDC Status Register (DDCSR) . . . . .	244
16.6.6	DDC Data Transmit Register (DDCDTR) . . . . .	246
16.6.7	DDC Data Receive Register (DDCDRR) . . . . .	247
16.7	Programming Considerations . . . . .	248

## Section 17. Sync Processor

17.1	Contents . . . . .	251
17.2	Introduction . . . . .	252
17.3	Features . . . . .	252
17.4	I/O Pins . . . . .	253
17.5	Functional Blocks . . . . .	255
17.5.1	Polarity Detection . . . . .	256
17.5.1.1	Hsync Polarity Detection . . . . .	256
17.5.1.2	Vsync Polarity Detection . . . . .	256
17.5.1.3	Composite Sync Polarity Detection . . . . .	256
17.5.2	Sync Signal Counters . . . . .	257

17.5.3	Polarity Controlled HOUT and VOUT Outputs . . . . .	257
17.5.4	Clamp Pulse Output . . . . .	258
17.5.5	Low Vertical Frequency Detect . . . . .	259
17.6	Sync Processor I/O Registers. . . . .	259
17.6.1	Sync Processor Control & Status Register (SPCSR). . . . .	259
17.6.2	Sync Processor Input/Output Control Register (SPIOCR) .	261
17.6.3	Vertical Frequency Registers (VFRs). . . . .	263
17.6.4	Hsync Frequency Registers (HFRs). . . . .	265
17.6.5	Sync Processor Control Register 1 (SPCR1). . . . .	267
17.6.6	H & V Sync Output Control Register (HVOCR) . . . . .	268
17.7	System Operation. . . . .	269

## Section 18. On-Screen Display (OSD)

18.1	Contents . . . . .	271
18.2	Introduction . . . . .	272
18.3	Features . . . . .	272
18.4	System Overview . . . . .	273
18.5	OSD FLASH Font Memory Map . . . . .	275
18.6	OSD Screen Memory Map . . . . .	276
18.7	OSD Module I/O Registers . . . . .	277
18.7.1	OSD Control Register (OSDCR) . . . . .	277
18.7.2	OSD Status Register (OSDSR) . . . . .	278
18.7.3	OSD Data Registers (OSDDRH:OSDDRL) . . . . .	279
18.7.4	OSD Row Address Register (OSDRAR) . . . . .	280
18.7.5	OSD Column Address Register (OSDCAR). . . . .	280
18.7.6	OSD FLASH Even High Byte Write Buffer (OSDEHBUF) .	281
18.8	OSD Registers . . . . .	282
18.8.1	OSD Display Registers (Attribute and Code Registers) . .	282
18.8.2	Row Attribute Registers . . . . .	283
18.8.3	Control, Window, and Pattern Registers . . . . .	283
18.8.3.1	Window Registers 1, 2, 3, 4 . . . . .	284
18.8.3.2	Vertical Delay Control Register . . . . .	285
18.8.3.3	Horizontal Delay Control Register . . . . .	286



18.8.3.4	Character Height Control Register .....	286
18.8.3.5	Frame Control Registers .....	288

## Section 19. Input/Output (I/O) Ports

19.1	Contents .....	293
19.2	Introduction .....	294
19.3	Port A .....	297
19.3.1	Port A Data Register .....	297
19.3.2	Data Direction Register A .....	298
19.3.3	Port A Options .....	299
19.4	Port B .....	300
19.4.1	Port B Data Register .....	300
19.4.2	Data Direction Register B .....	301
19.4.3	Port B Options .....	302
19.5	Port C .....	303
19.5.1	Port C Data Register .....	303
19.5.2	Data Direction Register C .....	304
19.5.3	Port C Options .....	305
19.6	Port D .....	306
19.6.1	Port D Data Register .....	306
19.6.2	Data Direction Register D .....	307
19.6.3	Port D Options .....	309
19.7	Port E .....	311
19.7.1	Port E Data Register .....	311
19.7.2	Data Direction Register E .....	312
19.7.3	Port E Options .....	313

## Section 20. External Interrupt (IRQ)

20.1	Contents .....	315
20.2	Introduction .....	315
20.3	Features .....	315
20.4	Functional Description .....	316

20.4.1	$\overline{\text{IRQ}}$ Pin . . . . .	318
20.5	IRQ Status and Control Register (INTSCR) . . . . .	319
20.6	IRQ Module During Break Interrupts . . . . .	320

## Section 21. Keyboard Interrupt Module (KBI)

21.1	Contents . . . . .	321
21.2	Introduction . . . . .	321
21.3	Features . . . . .	322
21.4	I/O Pins . . . . .	322
21.5	Functional Description . . . . .	323
21.6	Keyboard Initialization . . . . .	325
21.7	I/O Registers . . . . .	325
21.7.1	Keyboard Status and Control Register . . . . .	326
21.7.2	Keyboard Interrupt Enable Register . . . . .	327
21.8	Low-Power Modes . . . . .	327
21.8.1	Wait Mode . . . . .	327
21.8.2	Stop Mode . . . . .	327
21.9	Keyboard Module During Break Interrupts . . . . .	328

## Section 22. Computer Operating Properly (COP)

22.1	Contents . . . . .	329
22.2	Introduction . . . . .	329
22.3	Functional Description . . . . .	330
22.4	I/O Signals . . . . .	331
22.4.1	OSCCLK . . . . .	331
22.4.2	STOP Instruction . . . . .	331
22.4.3	COPCTL Write . . . . .	331
22.4.4	Power-On Reset . . . . .	331
22.4.5	Internal Reset . . . . .	332
22.4.6	Reset Vector Fetch . . . . .	332

22.4.7	COPD (COP Disable) . . . . .	332
22.4.8	COPRS (COP Rate Select) . . . . .	332
22.5	COP Control Register . . . . .	333
22.6	Interrupts . . . . .	333
22.7	Monitor Mode . . . . .	333
22.8	Low-Power Modes . . . . .	333
22.8.1	Wait Mode . . . . .	334
22.8.2	Stop Mode . . . . .	334
22.9	COP Module During Break Mode . . . . .	334

## Section 23. Break Module (BRK)

23.1	Contents . . . . .	335
23.2	Introduction . . . . .	335
23.3	Features . . . . .	336
23.4	Functional Description . . . . .	336
23.4.1	Flag Protection During Break Interrupts . . . . .	338
23.4.2	CPU During Break Interrupts . . . . .	338
23.4.3	TIM During Break Interrupts . . . . .	338
23.4.4	COP During Break Interrupts . . . . .	338
23.5	Low-Power Modes . . . . .	338
23.5.1	Wait Mode . . . . .	338
23.5.2	Stop Mode . . . . .	339
23.6	Break Module Registers . . . . .	339
23.6.1	Break Status and Control Register . . . . .	339
23.6.2	Break Address Registers . . . . .	340
23.6.3	SIM Break Status Register . . . . .	340
23.6.4	SIM Break Flag Control Register . . . . .	342

## Section 24. Electrical Specifications

24.1	Contents . . . . .	343
24.2	Introduction . . . . .	344

## Table of Contents

24.3	Absolute Maximum Ratings	344
24.4	Functional Operating Range	345
24.5	Thermal Characteristics	345
24.6	DC Electrical Characteristics	346
24.7	Control Timing	347
24.8	Timer Interface Module Characteristics	347
24.9	Oscillator Characteristics	347
24.10	ADC Electrical Characteristics	348
24.11	Sync Processor Timing	349
24.12	USB DC Electrical Characteristics	349
24.12.1	USB Low Speed Source Electrical Characteristics	350
24.12.2	USB High Speed Source Electrical Characteristics	351
24.12.3	HUB Repeater Electrical Characteristics	352
24.12.4	USB Signaling Levels	353
24.13	DDC12AB/MMIIC Timing	354
24.13.1	DDC12AB/MMIIC Interface Input Signal Timing	354
24.13.2	DDC12AB/MMIIC Interface Output Signal Timing	354
24.14	FLASH Memory Characteristics	355

## Section 25. Mechanical Specifications

25.1	Contents	357
25.2	Introduction	357
25.3	64-Pin Plastic Quad Flat Pack (QFP)	358

## Section 26. Ordering Information

26.1	Contents	359
26.2	Introduction	359
26.3	MC Order Numbers	359

## List of Figures

Figure	Title	Page
1-1	MC68HC908LD64 MCU Block Diagram . . . . .	35
1-2	64-Pin QFP Pin Assignment . . . . .	36
2-1	Memory Map . . . . .	43
2-2	Control, Status, and Data Registers . . . . .	45
4-1	FLASH I/O Register Summary . . . . .	64
4-2	47,616-byte FLASH Control Register (FLCR) . . . . .	66
4-3	13K-byte FLASH Control Register (FLCR1) . . . . .	66
4-4	OSD FLASH Even High Byte Write Buffer (OSDEHBUF) . . . . .	67
4-5	FLASH Programming Flowchart . . . . .	71
4-6	47,616-byte FLASH Block Protect Register (FLBPR) . . . . .	72
4-7	13K-byte FLASH Block Protect Register 1 (FLBPR1) . . . . .	72
4-8	FLASH Block Protect Start Address . . . . .	73
5-1	Configuration Register (CONFIG) . . . . .	76
6-1	CPU Registers . . . . .	79
6-2	Accumulator (A) . . . . .	79
6-3	Index Register (H:X) . . . . .	80
6-4	Stack Pointer (SP) . . . . .	80
6-5	Program Counter (PC) . . . . .	81
6-6	Condition Code Register (CCR) . . . . .	82
7-1	Oscillator External Connections . . . . .	96
8-1	CGM Block Diagram . . . . .	101
8-2	CGM I/O Register Summary . . . . .	102
8-3	PLL Control Register (PCTL) . . . . .	105
8-4	PLL Bandwidth Control Register (PBWC) . . . . .	107

# List of Figures

Figure	Title	Page
8-5	PLL Programming Register (PPG) . . . . .	108
8-6	H&V Sync Output Control Register (HVOCR) . . . . .	110
9-1	SIM Block Diagram . . . . .	115
9-2	SIM I/O Register Summary . . . . .	116
9-3	OSC Clock Signals . . . . .	117
9-4	External Reset Timing . . . . .	119
9-5	Internal Reset Timing . . . . .	119
9-6	Sources of Internal Reset . . . . .	119
9-7	POR Recovery . . . . .	120
9-8	Interrupt Entry . . . . .	124
9-9	Interrupt Recovery . . . . .	124
9-10	Interrupt Processing . . . . .	125
9-11	Interrupt Recognition Example . . . . .	126
9-12	Interrupt Status Register 1 (INT1) . . . . .	129
9-13	Interrupt Status Register 2 (INT2) . . . . .	129
9-14	Wait Mode Entry Timing . . . . .	131
9-15	Wait Recovery from Interrupt or Break . . . . .	132
9-16	Wait Recovery from Internal Reset . . . . .	132
9-17	Stop Mode Entry Timing . . . . .	133
9-18	Stop Mode Recovery from Interrupt or Break . . . . .	133
9-19	SIM Break Status Register (SBSR) . . . . .	134
9-20	SIM Reset Status Register (SRSR) . . . . .	135
9-21	SIM Break Flag Control Register (SBFCR) . . . . .	136
10-1	Monitor Mode Circuit . . . . .	139
10-2	Monitor Data Format . . . . .	143
10-3	Sample Monitor Waveforms . . . . .	143
10-4	Read Transaction . . . . .	143
10-5	Break Transaction . . . . .	144
11-1	TIM Block Diagram . . . . .	151
11-2	PWM Period and Pulse Width . . . . .	156
11-3	TIM Status and Control Register (TSC) . . . . .	161
11-4	TIM Counter Registers (TCNTH:TCNTL) . . . . .	163
11-5	TIM Counter Modulo Registers (TMODH:TMODL) . . . . .	164

<b>Figure</b>	<b>Title</b>	<b>Page</b>
11-6	TIM Channel Status and Control Registers (TSC0:TSC1) . . .	165
11-7	CHxMAX Latency . . . . .	168
11-8	TIM Channel Registers (TCH0H/L:TCH1H/L). . . . .	169
12-1	PWM I/O Register Summary . . . . .	172
12-2	PWM Data Registers 0 to 7 (0PWM–7PWM) . . . . .	173
12-3	PWM Control Register (PWMCR). . . . .	174
12-4	8-Bit PWM Output Waveforms . . . . .	175
13-1	ADC I/O Register Summary . . . . .	178
13-2	ADC Block Diagram . . . . .	179
13-3	ADC Status and Control Register (ADSCR). . . . .	183
13-4	ADC Data Register (ADR) . . . . .	185
13-5	ADC Input Clock Register (ADICLK) . . . . .	185
14-1	USB I/O Register Summary . . . . .	190
14-2	USB Module Block Diagram . . . . .	193
14-3	USB Hub Root Port Control Register (HRPCR) . . . . .	194
14-4	USB Hub Downstream Port Control Registers (HDP1CR–HDP4CR). . . . .	195
14-5	USB SIE Timing Interrupt Register (SIETIR) . . . . .	198
14-6	USB SIE Timing Status Register (SIETSR) . . . . .	200
14-7	USB Hub Address Register (HADDR) . . . . .	202
14-8	USB Hub Interrupt Register 0 (HIR0) . . . . .	203
14-9	USB Hub Control Register 0 (HCR0) . . . . .	205
14-10	USB Hub Endpoint 1 Control and Data Register (HCDR) . . .	206
14-11	USB Hub Status Register (HSR) . . . . .	208
14-12	USB Hub Endpoint 0 Data Registers (HE0D0–HE0D7) . . . .	209
14-13	USB Embedded Device Address Register (DADDR). . . . .	210
14-14	USB Embedded Device Interrupt Register 0 (DIR0). . . . .	210
14-15	USB Embedded Device Interrupt Register 1 (DIR1). . . . .	212
14-16	USB Embedded Device Control Register 0 (DCR0). . . . .	213
14-17	USB Embedded Device Control Register 1 (DCR1). . . . .	215
14-18	USB Embedded Device Control Register 2 (DCR2). . . . .	216
14-19	USB Embedded Device Status Register (DSR) . . . . .	217
14-20	USB Embedded Device Endpoint 0 Data Registers (DE0D0–DE0D7) . . . . .	219

# List of Figures

Figure	Title	Page
14-21	USB Embedded Device Endpoint 1/2 Data Registers (DE1D0–DE1D7) . . . . .	219
15-1	MMIIC I/O Register Summary . . . . .	223
15-2	Multi-Master IIC Address Register (MMADR) . . . . .	224
15-3	Multi-Master IIC Control Register (MMCR) . . . . .	225
15-4	Multi-Master IIC Master Control Register (MIMCR) . . . . .	226
15-5	Multi-Master IIC Status Register (MMSR) . . . . .	228
15-6	Multi-Master IIC Data Transmit Register (MMDTR) . . . . .	230
15-7	Multi-Master IIC Data Receive Register (MMDRR) . . . . .	231
15-8	Data Transfer Sequences for Master/Slave Transmit/Receive Modes . . . . .	233
16-1	DDC I/O Register Summary . . . . .	237
16-2	DDC Address Register (DDCADR) . . . . .	238
16-3	DDC2 Address Register (DDC2ADR) . . . . .	239
16-4	DDC Control Register (DDCCR) . . . . .	240
16-5	DDC Master Control Register (DDCMCR) . . . . .	241
16-6	DDC Status Register (DDCSR) . . . . .	244
16-7	DDC Data Transmit Register (DDCDTR) . . . . .	246
16-8	DDC Data Receive Register (DDCDRR) . . . . .	247
16-9	Data Transfer Sequences for Master/Slave Transmit/Receive Modes . . . . .	249
17-1	Sync Processor I/O Register Summary . . . . .	254
17-2	Sync Processor Block Diagram . . . . .	255
17-3	Clamp Pulse Output Timing . . . . .	258
17-4	Sync Processor Control & Status Register (SPCSR) . . . . .	259
17-5	Sync Processor Input/Output Control Register (SPIOCR) . . . . .	261
17-6	Vertical Frequency High Register . . . . .	263
17-7	Vertical Frequency Low Register . . . . .	263
17-8	Hsync Frequency High Register . . . . .	265
17-9	Hsync Frequency Low Register . . . . .	265
17-10	Sync Processor Control Register 1 (SPCR1) . . . . .	267
17-11	H&V Sync Output Control Register (HVOCR) . . . . .	268



<b>Figure</b>	<b>Title</b>	<b>Page</b>
18-1	On-Screen Display I/O Register Summary . . . . .	273
18-2	OSD Block Diagram . . . . .	274
18-3	Memory Map of OSD FLASH Fonts . . . . .	275
18-4	Memory Map of OSD Registers . . . . .	276
18-5	OSD Control Register (OSDCR) . . . . .	277
18-6	OSD Status Register (OSDSR) . . . . .	278
18-7	OSD Data Register High (OSDDRH) . . . . .	279
18-8	OSD Data Register Low (OSDDRL) . . . . .	279
18-9	OSD Row Address Register (OSDRAR) . . . . .	280
18-10	OSD Column Address Register (OSDCAR) . . . . .	280
18-11	OSD FLASH Even High Byte Write Buffer (OSDEHBUF) . . . . .	281
18-12	OSD Font Even Byte Buffer . . . . .	281
18-13	Character Font Matrix Height Expansion by CH[3:0] . . . . .	287
18-14	Display Character Height . . . . .	287
19-1	Port I/O Register Summary . . . . .	294
19-2	Port A Data Register (PTA) . . . . .	297
19-3	Data Direction Register A (DDRA) . . . . .	298
19-4	Port A I/O Circuit . . . . .	298
19-5	Keyboard Interrupt Enable Register (KIER) . . . . .	299
19-6	Port B Data Register (PTB) . . . . .	300
19-7	Data Direction Register B (DDRB) . . . . .	301
19-8	Port B I/O Circuit . . . . .	301
19-9	PWM Control Register (PWMCR) . . . . .	302
19-10	Port C Data Register (PTC) . . . . .	303
19-11	Data Direction Register C (DDRC) . . . . .	304
19-12	Port C I/O Circuit . . . . .	305
19-13	Port D Data Register (PTD) . . . . .	306
19-14	Data Direction Register D (DDR D) . . . . .	307
19-15	Port D I/O Circuit . . . . .	308
19-16	Port D Control Register (PDCR) . . . . .	309
19-17	Port E Data Register (PTE) . . . . .	311
19-18	Data Direction Register E (DDRE) . . . . .	312
19-19	Port E I/O Circuit . . . . .	312
19-20	Port E Control Register (PECR) . . . . .	313

## List of Figures

Figure	Title	Page
20-1	IRQ Module Block Diagram . . . . .	317
20-2	IRQ I/O Register Summary . . . . .	317
20-3	IRQ Status and Control Register (INTSCR) . . . . .	319
21-1	KBI I/O Register Summary . . . . .	322
21-2	Keyboard Interrupt Module Block Diagram . . . . .	323
21-3	Keyboard Status and Control Register (KBSCR) . . . . .	326
21-4	Keyboard Interrupt Enable Register (KBIER) . . . . .	327
22-1	COP Block Diagram . . . . .	330
22-2	Configuration Register (CONFIG) . . . . .	332
22-3	COP Control Register (COPCTL) . . . . .	333
23-1	Break Module Block Diagram . . . . .	337
23-2	Break Module I/O Register Summary . . . . .	337
23-3	Break Status and Control Register (BRKSCR) . . . . .	339
23-4	Break Address Register High (BRKH) . . . . .	340
23-5	Break Address Register Low (BRKL) . . . . .	340
23-6	SIM Break Status Register (SBSR) . . . . .	341
23-7	SIM Break Flag Control Register (SBFCR) . . . . .	342
24-1	MMIIC Signal Timings . . . . .	354
25-1	64-Pin QFP (Case #840B) . . . . .	358

## List of Tables

Table	Title	Page
1-1	Pin Functions . . . . .	37
2-1	Vector Addresses . . . . .	60
4-1	FLASH Memory Array Summary . . . . .	65
6-1	Instruction Set Summary . . . . .	86
6-2	Opcode Map . . . . .	94
8-1	Free-Running HSOUT, VSOUT, DE, and DCLK Settings . . .	102
8-2	VCO Frequency Multiplier (N) Selection. . . . .	109
9-1	Signal Name Conventions . . . . .	116
9-2	PIN Bit Set Timing . . . . .	118
9-3	Interrupt Sources . . . . .	128
9-4	SIM Registers Summary. . . . .	134
10-1	Monitor Mode Signal Requirements and Options. . . . .	141
10-2	Mode Differences . . . . .	142
10-3	READ (Read Memory) Command . . . . .	144
10-4	WRITE (Write Memory) Command. . . . .	145
10-5	IREAD (Indexed Read) Command . . . . .	145
10-6	IWRITE (Indexed Write) Command . . . . .	146
10-7	READSP (Read Stack Pointer) Command. . . . .	146
10-8	RUN (Run User Program) Command. . . . .	147
10-9	Monitor Baud Rate Selection . . . . .	147
11-1	Pin Name Conventions. . . . .	150
11-2	Prescaler Selection. . . . .	163
11-3	Mode, Edge, and Level Selection. . . . .	167

# List of Tables

Table	Title	Page
12-1	PWM Channels and Port I/O pins . . . . .	174
13-1	MUX Channel Select . . . . .	184
13-2	ADC Clock Divide Ratio . . . . .	186
14-1	USB I/O Pins. . . . .	190
15-1	Pin Name Conventions . . . . .	222
15-2	Baud Rate Select . . . . .	228
16-1	Pin Name Conventions . . . . .	236
16-2	Baud Rate Select . . . . .	243
17-1	Pin Name Conventions . . . . .	253
17-2	Sync Output Control . . . . .	257
17-3	Sync Output Polarity . . . . .	258
17-4	ATPOL, VINVO, and HINVO setting. . . . .	261
17-5	Sample Vertical Frame Frequencies . . . . .	264
17-6	Clamp Pulse Width . . . . .	265
17-7	HSYNC Polarity Detection Pulse Width . . . . .	267
17-8	ATPOL, VINVO, and HINVO setting. . . . .	268
17-9	Free-Running HSOUT, VSOUT, DE, and DCLK Settings . . . . .	269
18-1	Shadow Width Setting . . . . .	289
18-2	Shadow Width Setting . . . . .	290
19-1	Port Control Register Bits Summary. . . . .	296
19-2	Port A Pin Functions. . . . .	299
19-3	Port B Pin Functions. . . . .	302
19-4	Port C Pin Functions. . . . .	305
19-5	Port D Pin Functions. . . . .	308
19-6	Port E Pin Functions. . . . .	313
21-1	Pin Name Conventions . . . . .	322
24-1	Absolute Maximum Ratings . . . . .	344

<b>Table</b>	<b>Title</b>	<b>Page</b>
24-2	Operating Range . . . . .	345
24-3	Thermal Characteristics . . . . .	345
24-4	DC Electrical Characteristics . . . . .	346
24-5	Control Timing . . . . .	347
24-6	TIM Characteristics . . . . .	347
24-7	Oscillator Characteristics . . . . .	347
24-8	ADC Electrical Characteristics . . . . .	348
24-9	Sync Processor Timing . . . . .	349
24-10	USB DC Electrical Characteristics . . . . .	349
24-11	USB Low Speed Source Electrical Characteristics . . . . .	350
24-12	USB High Speed Source Electrical Characteristics . . . . .	351
24-13	HUB Repeater Electrical Characteristics . . . . .	352
24-14	USB Signaling Levels . . . . .	353
24-15	DDC12AB/MMIIC Interface Input Signal Timing . . . . .	354
24-16	DDC12AB/MMIIC Interface Output Signal Timing . . . . .	354
24-17	FLASH Memory Electrical Characteristics . . . . .	355
26-1	MC Order Numbers . . . . .	359



## Section 1. General Description

### 1.1 Contents

1.2	Introduction . . . . .	31
1.3	Features . . . . .	32
1.4	MCU Block Diagram . . . . .	34
1.5	Pin Assignments . . . . .	36
1.6	Pin Functions . . . . .	37

### 1.2 Introduction

The MC68HC908LD64 is a member of the low-cost, high-performance M68HC08 Family of 8-bit microcontroller units (MCUs). The M68HC08 Family is based on the customer-specified integrated circuit (CSIC) design strategy. All MCUs in the family use the enhanced M68HC08 central processor unit (CPU08) and are available with a variety of modules, memory sizes and types, and package types.

With special modules such as the sync processor, on-screen display module, analog-to-digital converter, pulse modulator module, DDC12AB interface, multi-master IIC interface, and universal serial bus interface, the MC68HC908LD64 is designed specifically for use in digital monitor systems.

## 1.3 Features

Features of the MC68HC908LD64 MCU include the following:

- High-performance M68HC08 architecture
- Fully upward-compatible object code with M6805, M146805, and M68HC05 families
- Low-power design; fully static with stop and wait modes
- 3.3V operating voltage
- 6MHz internal bus frequency; with 24MHz external crystal
- 60,928 bytes of on-chip FLASH memory with security<sup>1</sup> feature
- 2,048 bytes of on-chip random access memory (RAM)
- 39 general-purpose input/output (I/O) pins, including:
  - 38 shared-function I/O pins
  - 8-bit keyboard interrupt port
- 2-channel, 16-bit timer interface module (TIM) with selectable input capture, output compare, and PWM capability on one channel
- 6-channel, 8-bit analog-to-digital converter (ADC)
- 8-channel, 8-bit pulse width modulator (PWM)
- Sync signal processor with the following features:
  - Horizontal and vertical frequency counters
  - Low vertical frequency indicator (40.7Hz)
  - Polarity controlled Hsync and Vsync outputs from separate sync or composite sync inputs
  - Internal generated free-running Hsync, Vsync, DE, and DCLK
  - CLAMP pulse output to the external pre-amp chip
- On screen display (OSD) and full screen pattern display

---

1. No security feature is absolutely secure. However, Freescale's strategy is to make reading or copying the FLASH difficult for unauthorized users.



- Full Universal Serial Bus (USB) specification 1.1, composite hub with embedded functions, including:
  - One 12MHz upstream port
  - Four 12MHz/1.5MHz downstream ports
  - One hub control endpoint with 8-byte transmit buffer and 8-byte receive buffer
  - One hub interrupt endpoint with 1-byte transmit buffer
  - One device control endpoint with 8-byte transmit buffer and 8-byte receive buffer
  - Two device interrupt endpoints with shared 8-byte transmit buffer
- DDC12AB<sup>1</sup> module with the following:
  - DDC1 hardware
  - Multi-master IIC<sup>2</sup> hardware for DDC2AB; with dual address
- Additional multi-master IIC module
- In-system programming capability using USB or DDC12AB communication, or standard serial link on PTA0 pin
- System protection features:
  - Optional computer operating properly (COP) reset
  - Illegal opcode detection with reset
  - Illegal address detection with reset
- Master reset pin (with internal pull-up) and power-on reset
- $\overline{\text{IRQ}}$  interrupt pin with internal pull-up and schmitt-trigger input
- 64-pin quad flat pack (QFP) package

---

1. DDC is a VESA bus standard.

2. IIC is a proprietary Philips interface bus.

Features of the CPU08 include the following:

- Enhanced HC05 programming model
- Extensive loop control functions
- 16 addressing modes (eight more than the HC05)
- 16-bit index register and stack pointer
- Memory-to-memory data transfers
- Fast  $8 \times 8$  multiply instruction
- Fast 16/8 divide instruction
- Binary-coded decimal (BCD) instructions
- Optimization for controller applications
- Third party C language support

### 1.4 MCU Block Diagram

**Figure 1-1** shows the structure of the MC68HC908LD64.

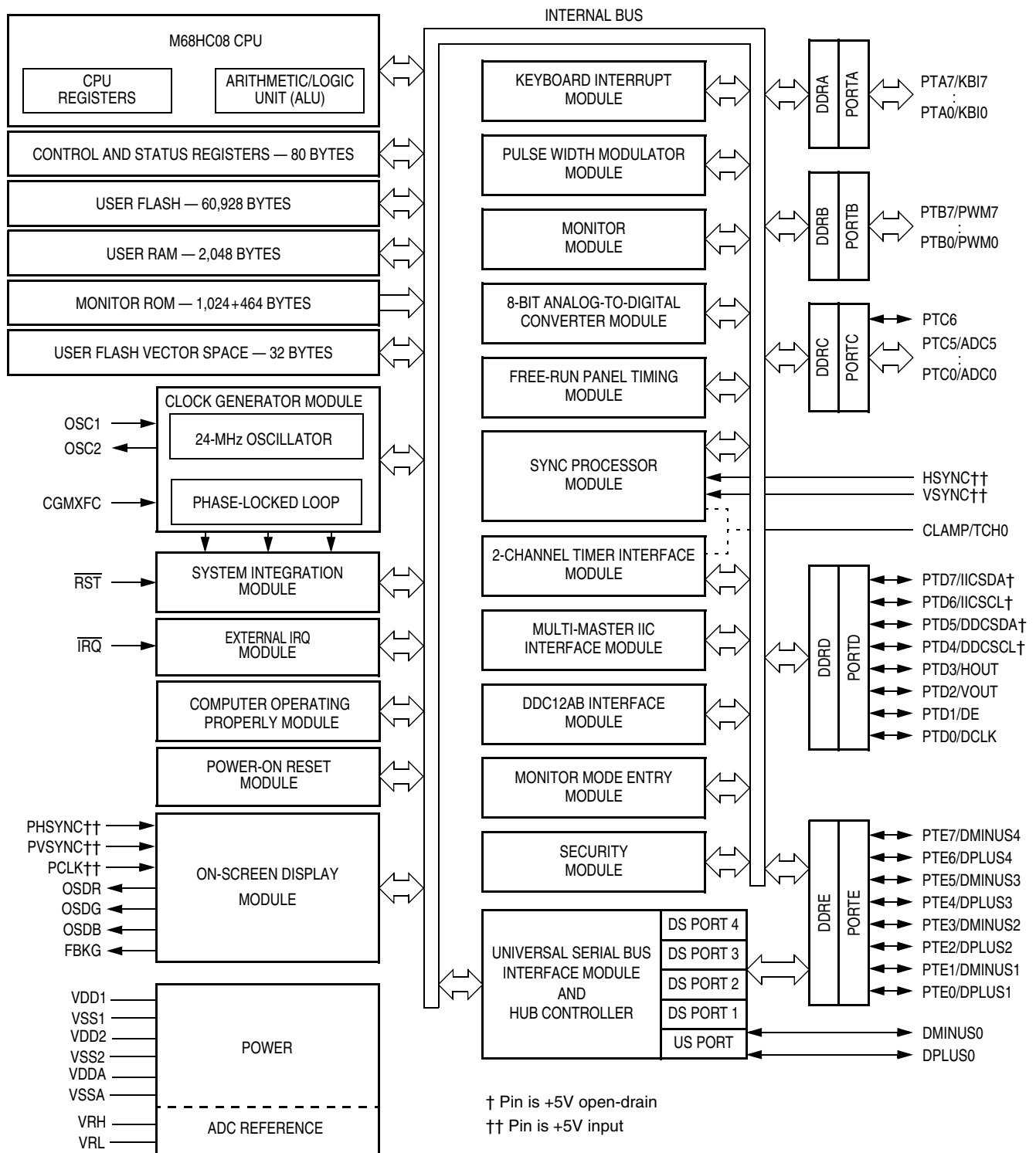

Figure 1-1. MC68HC908LD64 MCU Block Diagram

## 1.5 Pin Assignments

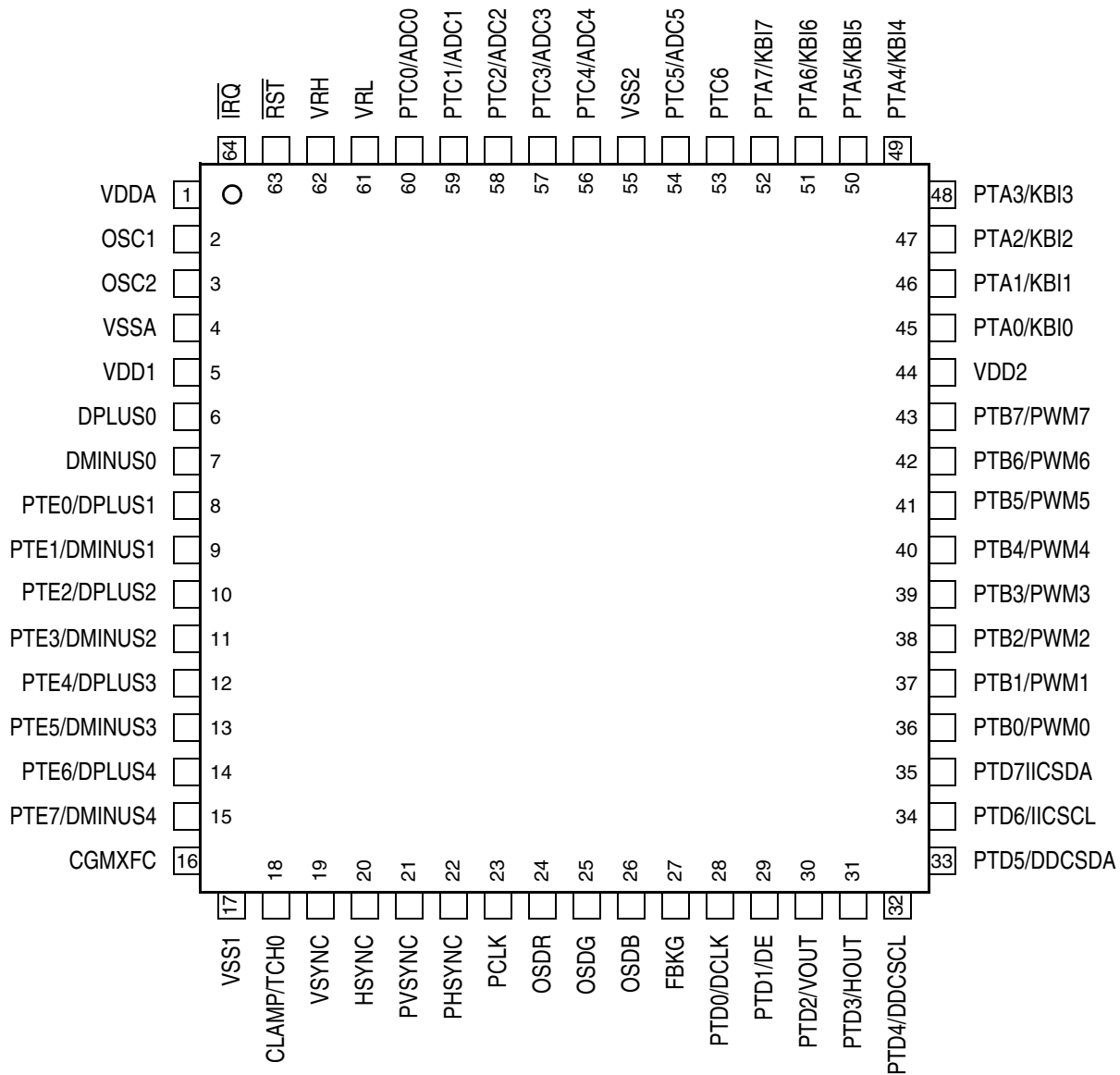

Figure 1-2. 64-Pin QFP Pin Assignment

## 1.6 Pin Functions

Description of the pin functions are provided in [Table 1-1](#).

**Table 1-1. Pin Functions**

PIN NAME	PIN DESCRIPTION
VDD1, VDD2	Power supply input to the MCU.
VSS1, VSS2	Power supply ground.
VDDA	Power supply input for analog circuits.
VSSA	Power supply ground for analog circuits.
OSC1, OSC2	Crystal connections to the on-chip oscillator. An external clock can be connected directly to OSC1; with OSC2 floating. See <a href="#">Section 7. Oscillator (OSC)</a> .
$\overline{\text{RST}}$	External reset pin; active low; with internal pull-up and schmitt trigger input. It is driven low when any internal reset source is asserted. See <a href="#">Section 9. System Integration Module (SIM)</a> .
$\overline{\text{IRQ}}$	External IRQ pin; with schmitt trigger input and internal pull-up. This pin is also used for mode entry selection. See <a href="#">Section 20. External Interrupt (IRQ)</a> and <a href="#">Section 9. System Integration Module (SIM)</a> .
CGMXFC	External filter capacitor connection for the CGM module. See <a href="#">Section 8. Clock Generator Module (CGM)</a> .
VSYNC	Vsync input to the sync processor. This pin is rated at +5V. See <a href="#">Section 17. Sync Processor</a> .
HSYNC	Hsync input to the sync processor. This pin is rated at +5V. See <a href="#">Section 17. Sync Processor</a> .
PTA7/KBI7–PTA0/KBI0	These are shared function, bidirectional I/O port pins. Each pin contains a pull-up device to VDD when it is configured as an external keyboard interrupt pin. See <a href="#">Section 19. Input/Output (I/O) Ports</a> and <a href="#">Section 21. Keyboard Interrupt Module (KBI)</a> .

**Table 1-1. Pin Functions (Continued)**

PIN NAME	PIN DESCRIPTION
PTB7/PWM7–PTB0/PWM0	These are shared-function, bidirectional I/O port pins. Each pin can be configured as a standard I/O pin or a PWM output channel. See <a href="#">Section 19. Input/Output (I/O) Ports</a> and <a href="#">Section 12. Pulse Width Modulator (PWM)</a> .
VRH	High voltage reference input to ADC module.
VRL	Low voltage reference input to ADC module.
PTC6	This pin is a standard bidirectional I/O pin. See <a href="#">Section 19. Input/Output (I/O) Ports</a> .
PTC5/ADC5–PTC0/ADC0	These are shared-function, bidirectional I/O port pins. Each pin can be configured as a standard I/O pin or an ADC input channel. See <a href="#">Section 19. Input/Output (I/O) Ports</a> and <a href="#">Section 13. Analog-to-Digital Converter (ADC)</a> .
PTD7/IICSDA	This is a shared-function pin. It can be configured as a standard I/O pin or the data line of the multi-master IIC module. This pin is +5V open-drain when configured as output. See <a href="#">Section 19. Input/Output (I/O) Ports</a> and <a href="#">Section 15. Multi-Master IIC Interface (MMIIC)</a> .
PTD6/IICSCL	This is a shared function pin. It can be configured as a standard I/O pin or the clock line of the multi-master IIC module. This pin is +5V open-drain when configured as output. See <a href="#">Section 19. Input/Output (I/O) Ports</a> and <a href="#">Section 15. Multi-Master IIC Interface (MMIIC)</a> .
PTD5/DDCSDA	This is a shared function pin. It can be configured as a standard I/O pin or the data line of the DDC12AB module. This pin is +5V open-drain when configured as output. See <a href="#">Section 19. Input/Output (I/O) Ports</a> and <a href="#">Section 16. DDC12AB Interface</a> .
PTD4/DDCSCL	This is a shared function pin. It can be configured as a standard I/O pin or the clock line of the DDC12AB module. This pin is +5V open-drain when configured as output. See <a href="#">Section 19. Input/Output (I/O) Ports</a> and <a href="#">Section 16. DDC12AB Interface</a> .

**Table 1-1. Pin Functions (Continued)**

PIN NAME	PIN DESCRIPTION
PTD3/HOUT PTD2/VOUT PTD1/DE PTD0/DCLK	These are shared function, bidirectional I/O port pins. These pins can be configured as standard I/O pins or free-run timing output signals. See <a href="#">Section 19. Input/Output (I/O) Ports</a> and <a href="#">Section 17. Sync Processor</a> .
CLAMP/TCH0	This is shared function pins. This TIM channel 0 I/O pin can be configured as the Sync processor CLAMP output pin. See <a href="#">Section 11. Timer Interface Module (TIM)</a> and <a href="#">Section 17. Sync Processor</a> .
PVSYNC	Vsync input to the On-Screen Display module. This pin is rated at +5V. See <a href="#">Section 18. On-Screen Display (OSD)</a> .
PHSYNC	Hsync input to the On-Screen Display module. This pin is rated at +5V. See <a href="#">Section 18. On-Screen Display (OSD)</a> .
PCLK	Pixel clock input to the On-Screen Display module. This pin is rated at +5V. See <a href="#">Section 18. On-Screen Display (OSD)</a> .
OSDR OSDG OSDB	R, G, and B output of the On-Screen Display module. See <a href="#">Section 18. On-Screen Display (OSD)</a> .
FBKG	Pixel-enable output of the On-Screen Display module. See <a href="#">Section 18. On-Screen Display (OSD)</a> .
PTE7/DMINUS4 PTE6/DPLUS4 PTE5/DMINUS3 PTE4/4DPLUS3 PTE3/DMINUS2 PTE2/DPLUS2 PTE1/DMINUS1 PTE0/DPLUS1	These are shared function, bidirectional I/O port pins. These pins can be configured as standard I/O pins or downstream data pins of USB module. See <a href="#">Section 19. Input/Output (I/O) Ports</a> and <a href="#">Section 14. Universal Serial Bus Module (USB)</a> .
DPLUS0 DMINUS0	Data pins of USB module upstream port. See <a href="#">Section 14. Universal Serial Bus Module (USB)</a> .

**NOTE:** Any unused inputs and I/O ports should be tied to an appropriate logic level (either  $V_{DD}$  or  $V_{SS}$ ). Although the I/O ports of the MC68HC908LD64 do not require termination, termination is recommended to reduce the possibility of static damage.





## Section 2. Memory Map

### 2.1 Contents

2.2	Introduction . . . . .	41
2.3	Unimplemented Memory Locations . . . . .	41
2.4	Reserved Memory Locations . . . . .	42
2.5	Input/Output (I/O) Section. . . . .	42

### 2.2 Introduction

The CPU08 can address 64K-bytes of memory space. The memory map, shown in **Figure 2-1**, includes:

- 60,928 bytes of FLASH memory
- 2,048 bytes of random-access memory (RAM)
- 32 bytes of user-defined vectors
- 1,024 + 464 bytes of monitor ROM

### 2.3 Unimplemented Memory Locations

Accessing an unimplemented location can cause an illegal address reset if illegal address resets are enabled. In the memory map (**Figure 2-1**) and in register figures in this document, unimplemented locations are shaded.

## 2.4 Reserved Memory Locations

Accessing a reserved location can have unpredictable effects on MCU operation. In the [Figure 2-1](#) and in register figures in this document, reserved locations are marked with the word Reserved or with the letter R.

## 2.5 Input/Output (I/O) Section

Most of the control, status, and data registers are in the zero page area of \$0000–\$007F. Additional I/O registers have these addresses:

- \$FE00; SIM break status register, SBSR
- \$FE01; SIM reset status register, SRSR
- \$FE02; Reserved
- \$FE03; SIM break flag control register, SBFCR
- \$FE04; Interrupt status register 1, INT1
- \$FE05; Interrupt status register 2, INT2
- \$FE06; Reserved
- \$FE07; 47,616 bytes FLASH control register, FLCR
- \$FE08; 47,616 bytes FLASH block protect register, FLBPR
- \$FE09; Reserved
- \$FE0A; 13K-bytes FLASH control register, FLCR1
- \$FE0B; 13K-bytes FLASH block protect register, FLBPR1
- \$FE0C; Break address register high, BRKH
- \$FE0D; Break address register low, BRKL
- \$FE0E; Break status and control register, BRKSCR
- \$FE0F; Reserved
- \$FFFF; COP control register, COPCTL

Data registers are shown in [Figure 2-2](#). [Table 2-1](#) is a list of vector locations.

\$0000 ↓ \$007F	I/O Registers 128 Bytes
\$0080 ↓ \$047F	RAM 1,024 Bytes
\$0480 ↓ \$07FF	Unimplemented 896 Bytes
\$0800 ↓ \$0BFF	OSD RAM 1,024 Bytes
\$0C00 ↓ \$0FFF	FLASH Memory 1,024 Bytes (8 × 128-Byte Blocks)
\$1000 ↓ \$3FFF	OSD FLASH Memory 12,288 Bytes (24 × 512-Byte Blocks)
\$4000 ↓ \$F9FF	FLASH Memory 47,616 Bytes (93 × 512-Byte Blocks)
\$FA00 ↓ \$FDFF	Monitor ROM 1,024 Bytes
\$FE00	SIM Break Status Register (SBSR)
\$FE01	SIM Reset Status Register (SRSR)
\$FE02	Reserved
\$FE03	SIM Break Flag Control Register (SBFCR)
\$FE04	Interrupt Status Register 1 (INT1)

**Figure 2-1. Memory Map**

# Memory Map

\$FE05	Interrupt Status Register 2 (INT2)
\$FE06	Reserved
\$FE07	47,616 bytes FLASH Control Register (FLCR)
\$FE08	47,616 bytes FLASH Block Protect Register (FLBPR)
\$FE09	Reserved
\$FE0A	13K-bytes FLASH Control Register (FLCR1)
\$FE0B	13K-bytes FLASH Block Protect Register (FLBPR1)
\$FE0C	Break Address Register High (BRKH)
\$FE0D	Break Address Register Low (BRKL)
\$FE0E	Break Status and Control Register (BRKSCR)
\$FE0F	Reserved
\$FE10	Monitor ROM 464 Bytes
↓	
\$FFDF	FLASH Vectors 32 Bytes
\$FFE0	
↓	
\$FFFF	

**Figure 2-1. Memory Map (Continued)**

Addr.	Register Name	Bit 7	6	5	4	3	2	1	Bit 0	
\$0000	Port A Data Register (PTA)	Read:	PTA7	PTA6	PTA5	PTA4	PTA3	PTA2	PTA1	PTA0
		Write:								
		Reset:	Unaffected by reset							
\$0001	Port B Data Register (PTB)	Read:	PTB7	PTB6	PTB5	PTB4	PTB3	PTB2	PTB1	PTB0
		Write:								
		Reset:	Unaffected by reset							
\$0002	Port C Data Register (PTC)	Read:	0	PTC6	PTC5	PTC4	PTC3	PTC2	PTC1	PTC0
		Write:								
		Reset:	Unaffected by reset							
\$0003	Port D Data Register (PTD)	Read:	PTD7	PTD6	PTD5	PTD4	PTD3	PTD2	PTD1	PTD0
		Write:								
		Reset:	Unaffected by reset							
\$0004	Data Direction Register A (DDRA)	Read:	DDRA7	DDRA6	DDRA5	DDRA4	DDRA3	DDRA2	DDRA1	DDRA0
		Write:								
		Reset:	0	0	0	0	0	0	0	0
\$0005	Data Direction Register B (DDRB)	Read:	DDRB7	DDRB6	DDRB5	DDRB4	DDRB3	DDRB2	DDRB1	DDRB0
		Write:								
		Reset:	0	0	0	0	0	0	0	0
\$0006	Data Direction Register C (DDRC)	Read:	0	DDRC6	DDRC5	DDRC4	DDRC3	DDRC2	DDRC1	DDRC0
		Write:								
		Reset:	0	0	0	0	0	0	0	0
\$0007	Data Direction Register D (DDRD)	Read:	DDRD7	DDRD6	DDRD5	DDRD4	DDRD3	DDRD2	DDRD1	DDRD0
		Write:								
		Reset:	0	0	0	0	0	0	0	0
\$0008	Port E Data Register (PTE)	Read:	PTE7	PTE6	PTE5	PTE4	PTE3	PTE2	PTE1	PTE0
		Write:								
		Reset:	Unaffected by reset							
\$0009	Data Direction Register E (DDRE)	Read:	DDRE7	DDRE6	DDRE5	DDRE4	DDRE3	DDRE2	DDRE1	DDRE0
		Write:								
		Reset:	0	0	0	0	0	0	0	0

U = Unaffected      X = Indeterminate       = Unimplemented      R = Reserved

**Figure 2-2. Control, Status, and Data Registers (Sheet 1 of 15)**

# Memory Map

Addr.	Register Name		Bit 7	6	5	4	3	2	1	Bit 0
\$000A	TIM Status and Control Register (TSC)	Read:	TOF	TOIE	TSTOP	0	0	PS2	PS1	PS0
		Write:	0			TRST				
		Reset:	0	0	1	0	0	0	0	0
\$000B	Unimplemented	Read:								
		Write:								
		Reset:	0	0	0	0	0	0	0	0
\$000C	TIM Counter Register High (TCNTH)	Read:	Bit15	Bit14	Bit13	Bit12	Bit11	Bit10	Bit9	Bit8
		Write:								
		Reset:	0	0	0	0	0	0	0	0
\$000D	TIM Counter Register Low (TCNTL)	Read:	Bit7	Bit6	Bit5	Bit4	Bit3	Bit2	Bit1	Bit0
		Write:								
		Reset:	0	0	0	0	0	0	0	0
\$000E	TIM Counter Modulo Register High (TMODH)	Read:	Bit15	Bit14	Bit13	Bit12	Bit11	Bit10	Bit9	Bit8
		Write:								
		Reset:	1	1	1	1	1	1	1	1
\$000F	TIM Counter Modulo Register Low (TMDL)	Read:	Bit7	Bit6	Bit5	Bit4	Bit3	Bit2	Bit1	Bit0
		Write:								
		Reset:	1	1	1	1	1	1	1	1
\$0010	TIM Channel 0 Status and Control Register (TSC0)	Read:	CH0F	CH0IE	MS0B	MS0A	ELS0B	ELS0A	TOV0	CH0MAX
		Write:	0							
		Reset:	0	0	0	0	0	0	0	0
\$0011	TIM Channel 0 Register High (TCH0H)	Read:	Bit15	Bit14	Bit13	Bit12	Bit11	Bit10	Bit9	Bit8
		Write:								
		Reset:	Indeterminate after reset							
\$0012	TIM Channel 0 Register Low (TCH0L)	Read:	Bit7	Bit6	Bit5	Bit4	Bit3	Bit2	Bit1	Bit0
		Write:								
		Reset:	Indeterminate after reset							
\$0013	TIM Channel 1 Status and Control Register (TSC1)	Read:	CH1F	CH1IE	0	MS1A	ELS1B	ELS1A	TOV1	CH1MAX
		Write:	0							
		Reset:	0	0	0	0	0	0	0	0

U = Unaffected      X = Indeterminate       = Unimplemented      R = Reserved

**Figure 2-2. Control, Status, and Data Registers (Sheet 2 of 15)**

Addr.	Register Name	Bit 7	6	5	4	3	2	1	Bit 0	
\$0014	TIM Channel 1 Register High (TCH1H)	Read:	Bit15	Bit14	Bit13	Bit12	Bit11	Bit10	Bit9	Bit8
		Write:								
		Reset:	Indeterminate after reset							
\$0015	TIM Channel 1 Register Low (TCH1L)	Read:	Bit7	Bit6	Bit5	Bit4	Bit3	Bit2	Bit1	Bit0
		Write:								
		Reset:	Indeterminate after reset							
\$0016	DDC Master Control Register (DDCMCR)	Read:	ALIF	NAKIF	BB	MAST	MRW	BR2	BR1	BR0
		Write:								
		Reset:	0	0	0	0	0	0	0	0
\$0017	DDC Address Register (DDCADR)	Read:	DAD7	DAD6	DAD5	DAD4	DAD3	DAD2	DAD1	EXTAD
		Write:								
		Reset:	1	0	1	0	0	0	0	0
\$0018	DDC Control Register (DDCCR)	Read:	DEN	DIEN	0	0	TXAK	SCLIEN	DDC1EN	0
		Write:								
		Reset:	0	0	0	0	0	0	0	0
\$0019	DDC Status Register (DDCSR)	Read:	RXIF	TXIF	MATCH	SRW	RXAK	SCLIF	TXBE	RXBF
		Write:	0	0				0		
		Reset:	0	0	0	0	1	0	1	0
\$001A	DDC Data Transmit Register (DDCDTR)	Read:	DTD7	DTD6	DTD5	DTD4	DTD3	DTD2	DTD1	DTD0
		Write:								
		Reset:	1	1	1	1	1	1	1	1
\$001B	DDC Data Receive Register (DDCDRR)	Read:	DRD7	DRD6	DRD5	DRD4	DRD3	DRD2	DRD1	DRD0
		Write:								
		Reset:	0	0	0	0	0	0	0	0
\$001C	DDC2 Address Register (DDC2ADR)	Read:	D2AD7	D2AD6	D2AD5	D2AD4	D2AD3	D2AD2	D2AD1	0
		Write:								
		Reset:	0	0	0	0	0	0	0	0
\$001D	Unimplemented	Read:								
		Write:								
		Reset:								

U = Unaffected      X = Indeterminate       = Unimplemented      R = Reserved

**Figure 2-2. Control, Status, and Data Registers (Sheet 3 of 15)**

# Memory Map

Addr.	Register Name		Bit 7	6	5	4	3	2	1	Bit 0
\$001E	IRQ Status and Control Register (INTSCR)	Read:	0	0	0	0	IRQF	0	IMASK	MODE
		Write:						ACK		
		Reset:	0	0	0	0	0	0	0	0
\$001F	Configuration Register (CONFIG) <sup>†</sup>	Read:	0	0	0	0	SSREC	COPRS	STOP	COPD
		Write:								
		Reset:	0	0	0	0	0	0	0	0

<sup>†</sup> One-time writable register after each reset.

\$0020	USB Embedded Device Endpoint 0 Data Reg. 0 (DE0D0)	Read:	DE0R07	DE0R06	DE0R05	DE0R04	DE0R03	DE0R02	DE0R01	DE0R00
		Write:	DE0T07	DE0T06	DE0T05	DE0T04	DE0T03	DE0T02	DE0T01	DE0T00
		Reset:	Indeterminate after reset							
\$0021	USB Embedded Device Endpoint 0 Data Reg. 1 (DE0D1)	Read:	DE0R17	DE0R16	DE0R15	DE0R14	DE0R13	DE0R12	DE0R11	DE0R10
		Write:	DE0T17	DE0T16	DE0T15	DE0T14	DE0T13	DE0T12	DE0T11	DE0T10
		Reset:	Indeterminate after reset							
\$0022	USB Embedded Device Endpoint 0 Data Reg. 2 (DE0D2)	Read:	DE0R27	DE0R26	DE0R25	DE0R24	DE0R23	DE0R22	DE0R21	DE0R20
		Write:	DE0T27	DE0T26	DE0T25	DE0T24	DE0T23	DE0T22	DE0T21	DE0T20
		Reset:	Indeterminate after reset							
\$0023	USB Embedded Device Endpoint 0 Data Reg. 3 (DE0D3)	Read:	DE0R37	DE0R36	DE0R35	DE0R34	DE0R33	DE0R32	DE0R31	DE0R30
		Write:	DE0T37	DE0T36	DE0T35	DE0T34	DE0T33	DE0T32	DE0T31	DE0T30
		Reset:	Indeterminate after reset							
\$0024	USB Embedded Device Endpoint 0 Data Reg. 4 (DE0D4)	Read:	DE0R47	DE0R46	DE0R45	DE0R44	DE0R43	DE0R42	DE0R41	DE0R40
		Write:	DE0T47	DE0T46	DE0T45	DE0T44	DE0T43	DE0T42	DE0T41	DE0T40
		Reset:	Indeterminate after reset							
\$0025	USB Embedded Device Endpoint 0 Data Reg. 5 (DE0D5)	Read:	DE0R57	DE0R56	DE0R55	DE0R54	DE0R53	DE0R52	DE0R51	DE0R50
		Write:	DE0T57	DE0T56	DE0T55	DE0T54	DE0T53	DE0T52	DE0T51	DE0T50
		Reset:	Indeterminate after reset							
\$0026	USB Embedded Device Endpoint 0 Data Reg. 6 (DE0D6)	Read:	DE0R67	DE0R66	DE0R65	DE0R64	DE0R63	DE0R62	DE0R61	DE0R60
		Write:	DE0T67	DE0T66	DE0T65	DE0T64	DE0T63	DE0T62	DE0T61	DE0T60
		Reset:	Indeterminate after reset							
\$0027	USB Embedded Device Endpoint 0 Data Reg. 7 (DE0D7)	Read:	DE0R77	DE0R76	DE0R75	DE0R74	DE0R73	DE0R72	DE0R71	DE0R70
		Write:	DE0T77	DE0T76	DE0T75	DE0T74	DE0T73	DE0T72	DE0T71	DE0T70
		Reset:	Indeterminate after reset							

U = Unaffected      X = Indeterminate       = Unimplemented       = Reserved

**Figure 2-2. Control, Status, and Data Registers (Sheet 4 of 15)**



Addr.	Register Name		Bit 7	6	5	4	3	2	1	Bit 0
\$0028	USB Embedded Device Endpoint 1/2 Data Reg. 0 (DE1D0)	Read:								
		Write:	DE1T07	DE1T06	DE1T05	DE1T04	DE1T03	DE1T02	DE1T01	DE1T00
		Reset:	Indeterminate after reset							
\$0029	USB Embedded Device Endpoint 1/2 Data Reg. 1 (DE1D1)	Read:								
		Write:	DE1T17	DE1T16	DE1T15	DE1T14	DE1T13	DE1T12	DE1T11	DE1T10
		Reset:	Indeterminate after reset							
\$002A	USB Embedded Device Endpoint 1/2 Data Reg. 2 (DE1D2)	Read:								
		Write:	DE1T27	DE1T26	DE1T25	DE1T24	DE1T23	DE1T22	DE1T21	DE1T20
		Reset:	Indeterminate after reset							
\$002B	USB Embedded Device Endpoint 1/2 Data Reg. 3 (DE1D3)	Read:								
		Write:	DE1T37	DE1T36	DE1T35	DE1T34	DE1T33	DE1T32	DE1T31	DE1T30
		Reset:	Indeterminate after reset							
\$002C	USB Embedded Device Endpoint 1/2 Data Reg. 4 (DE1D4)	Read:								
		Write:	DE1T47	DE1T46	DE1T45	DE1T44	DE1T43	DE1T42	DE1T41	DE1T40
		Reset:	Indeterminate after reset							
\$002D	USB Embedded Device Endpoint 1/2 Data Reg. 5 (DE1D5)	Read:								
		Write:	DE1T57	DE1T56	DE1T55	DE1T54	DE1T53	DE1T52	DE1T51	DE1T50
		Reset:	Indeterminate after reset							
\$002E	USB Embedded Device Endpoint 1/2 Data Reg. 6 (DE1D6)	Read:								
		Write:	DE1T67	DE1T66	DE1T65	DE1T64	DE1T63	DE1T62	DE1T61	DE1T60
		Reset:	Indeterminate after reset							
\$002F	USB Embedded Device Endpoint 1/2 Data Reg. 7 (DE1D7)	Read:								
		Write:	DE1T77	DE1T76	DE1T75	DE1T74	DE1T73	DE1T72	DE1T71	DE1T70
		Reset:	Indeterminate after reset							
\$0030	USB HUB Endpoint 0 Data Register 0 (HE0D0)	Read:	HE0R07	HE0R06	HE0R05	HE0R04	HE0R03	HE0R02	HE0R01	HE0R00
		Write:	HE0T07	HE0T06	HE0T05	HE0T04	HE0T03	HE0T02	HE0T01	HE0T00
		Reset:	Indeterminate after reset							
\$0031	USB HUB Endpoint 0 Data Register 1 (HE0D1)	Read:	HE0R17	HE0R16	HE0R15	HE0R14	HE0R13	HE0R12	HE0R11	HE0R10
		Write:	HE0T17	HE0T16	HE0T15	HE0T14	HE0T13	HE0T12	HE0T11	HE0T10
		Reset:	Indeterminate after reset							

U = Unaffected      X = Indeterminate       = Unimplemented      R = Reserved

**Figure 2-2. Control, Status, and Data Registers (Sheet 5 of 15)**

# Memory Map

Addr.	Register Name	Bit 7	6	5	4	3	2	1	Bit 0	
\$0032	USB HUB Endpoint 0 Data Register 2 (HE0D2)	Read:	HE0R27	HE0R26	HE0R25	HE0R24	HE0R23	HE0R22	HE0R21	HE0R20
		Write:	HE0T27	HE0T26	HE0T25	HE0T24	HE0T23	HE0T22	HE0T21	HE0T20
		Reset:	Indeterminate after reset							
\$0033	USB HUB Endpoint 0 Data Register 3 (HE0D3)	Read:	HE0R37	HE0R36	HE0R35	HE0R34	HE0R33	HE0R32	HE0R31	HE0R30
		Write:	HE0T37	HE0T36	HE0T35	HE0T34	HE0T33	HE0T32	HE0T31	HE0T30
		Reset:	Indeterminate after reset							
\$0034	USB HUB Endpoint 0 Data Register 4 (HE0D4)	Read:	HE0R47	HE0R46	HE0R45	HE0R44	HE0R43	HE0R42	HE0R41	HE0R40
		Write:	HE0T47	HE0T46	HE0T45	HE0T44	HE0T43	HE0T42	HE0T41	HE0T40
		Reset:	Indeterminate after reset							
\$0035	USB HUB Endpoint 0 Data Register 5 (HE0D5)	Read:	HE0R57	HE0R56	HE0R55	HE0R54	HE0R53	HE0R52	HE0R51	HE0R50
		Write:	HE0T57	HE0T56	HE0T55	HE0T54	HE0T53	HE0T52	HE0T51	HE0T50
		Reset:	Indeterminate after reset							
\$0036	USB HUB Endpoint 0 Data Register 6 (HE0D6)	Read:	HE0R67	HE0R66	HE0R65	HE0R64	HE0R63	HE0R62	HE0R61	HE0R60
		Write:	HE0T67	HE0T66	HE0T65	HE0T64	HE0T63	HE0T62	HE0T61	HE0T60
		Reset:	Indeterminate after reset							
\$0037	USB HUB Endpoint 0 Data Register 7 (HE0D7)	Read:	HE0R77	HE0R76	HE0R75	HE0R74	HE0R73	HE0R72	HE0R71	HE0R70
		Write:	HE0T77	HE0T76	HE0T75	HE0T74	HE0T73	HE0T72	HE0T71	HE0T70
		Reset:	Indeterminate after reset							
\$0038	PLL Control Register (PCTL)	Read:	PLLIE	PLLF	PLLON	BCS	1	1	1	1
		Write:								
		Reset:	0	0	1	0	1	1	1	1
\$0039	PLL Bandwidth Control Register (PBWC)	Read:	AUTO	LOCK	ACQ	XLD	0	0	0	0
		Write:								
		Reset:	0	0	0	0	0	0	0	0
\$003A	PLL Programming Register (PPG)	Read:	MUL7	MUL6	MUL5	MUL4	VRS7	VRS6	VRS5	VRS4
		Write:								
		Reset:	0	1	1	0	0	1	1	0
\$003B	ADC Status and Control Register (ADSCR)	Read:	COCO	AIEN	ADCO	ADCH4	ADCH3	ADCH2	ADCH1	ADCH0
		Write:								
		Reset:	0	0	0	1	1	1	1	1

U = Unaffected      X = Indeterminate       = Unimplemented       = Reserved

**Figure 2-2. Control, Status, and Data Registers (Sheet 6 of 15)**

Addr.	Register Name	Bit 7	6	5	4	3	2	1	Bit 0	
\$003C	ADC Data Register (ADR)	Read:	AD7	AD6	AD5	AD4	AD3	AD2	AD1	AD0
		Write:								
		Reset:	Indeterminate after reset							
\$003D	ADC Input Clock Register (ADICLK)	Read:	ADIV2	ADIV1	ADIV0	0	0	0	0	0
		Write:								
		Reset:	0	0	0	0	0	0	0	0
\$003E	Unimplemented	Read:								
		Write:								
		Reset:								
\$003F	H & V Sync Output Control Register (HVOCR)	Read:				DCLKPH1	DCLKPH0	R	HVOCR1	HVOCR0
		Write:								
		Reset:				0	0		0	0
\$0040	Sync Processor Control and Status Register (SPCSR)	Read:	VSIE	VEDGE	VSIF	COMP	VINVO	HINVO	VPOL	HPOL
		Write:			0					
		Reset:	0	0	0	0	0	0	0	0
\$0041	Vertical Frequency High Register (VFHR)	Read:	VOF	0	0	VF12	VF11	VF10	VF9	VF8
		Write:		CPW1	CPW0					
		Reset:	0	0	0	0	0	0	0	0
\$0042	Vertical Frequency Low Register (VFLR)	Read:	VF7	VF6	VF5	VF4	VF3	VF2	VF1	VF0
		Write:								
		Reset:	0	0	0	0	0	0	0	0
\$0043	Hsync Frequency High Register (HFHR)	Read:	HFH7	HFH6	HFH5	HFH4	HFH3	HFH2	HFH1	HFH0
		Write:								
		Reset:	0	0	0	0	0	0	0	0
\$0044	Hsync Frequency Low Register (HFLR)	Read:	HOVER	0	0	HFL4	HFL3	HFL2	HFL1	HFL0
		Write:								
		Reset:	0	0	0	0	0	0	0	0
\$0045	Sync Processor I/O Control Register (SPIOCR)	Read:	VSYNCS	HSYNCS	COINV	R	R	R	BPOR	SOUT
		Write:								
		Reset:	0	0	0				0	0

U = Unaffected      X = Indeterminate       = Unimplemented       = Reserved

**Figure 2-2. Control, Status, and Data Registers (Sheet 7 of 15)**

# Memory Map

Addr.	Register Name	Bit 7	6	5	4	3	2	1	Bit 0	
\$0046	Sync Processor Control Register 1 (SPCR1)	Read:	LVSIE	LVSIF	HPS1	HPS0	R	R	ATPOL	FSHF
		Write:		0						
		Reset:	0	0	0	0			0	0
\$0047	USB Embedded Device Control Register 2 (DCR2)	Read:	0	0	0	0	ENABLE2	ENABLE1	DSTALL2	DSTALL1
		Write:								
		Reset:	0	0	0	0	0	0	0	0
\$0048	USB Embedded Device Address Register (DADDR)	Read:	DEVEN	DADD6	DADD5	DADD4	DADD3	DADD2	DADD1	DADD0
		Write:								
		Reset:	0	0	0	0	0	0	0	0
\$0049	USB Embedded Device Interrupt Register 0 (DIR0)	Read:	TXD0F	RXD0F	0	0	TXD0IE	RXD0IE	0	0
		Write:							TXD0FR	RXD0FR
		Reset:	0	0	0	0	0	0	0	0
\$004A	USB Embedded Device Interrupt Register 1 (DIR1)	Read:	TXD1F	0	0	0	TXD1IE	0	0	0
		Write:							TXD1FR	
		Reset:	0	0	0	0	0	0	0	0
\$004B	USB Embedded Device Control Register 0 (DCR0)	Read:	T0SEQ	DSTALL0	TX0E	RX0E	TP0SIZ3	TP0SIZ2	TP0SIZ1	TP0SIZ0
		Write:								
		Reset:	0	0	0	0	0	0	0	0
\$004C	USB Embedded Device Control Register 1 (DCR1)	Read:	T1SEQ	ENDADD	TX1E	0	TP1SIZ3	TP1SIZ2	TP1SIZ1	TP1SIZ0
		Write:								
		Reset:	0	0	0	0	0	0	0	0
\$004D	USB Embedded Device Status Register (DSR)	Read:	DRSEQ	DSETUP	DTX1ST	0	RP0SIZ3	RP0SIZ2	RP0SIZ1	RP0SIZ0
		Write:				DTX1STR				
		Reset:	0	0	0	0	0	0	0	0
\$004E	Keyboard Status and Control Register (KBSCR)	Read:	0	0	0	0	KEYF	0	IMASKK	MODEK
		Write:						ACKK		
		Reset:	0	0	0	0	0	0	0	0
\$004F	Keyboard Interrupt Enable Register (KBIER)	Read:	KBIE7	KBIE6	KBIE5	KBIE4	KBIE3	KBIE2	KBIE1	KBIE0
		Write:								
		Reset:	0	0	0	0	0	0	0	0

U = Unaffected      X = Indeterminate       = Unimplemented       = Reserved

**Figure 2-2. Control, Status, and Data Registers (Sheet 8 of 15)**

Addr.	Register Name	Bit 7	6	5	4	3	2	1	Bit 0
\$0050	Unimplemented	Read: [Unimplemented] Write: [Unimplemented] Reset:							
\$0051	USB HUB Downstream Port 1 Control Register (HDP1CR)	PEN1	LOWSP1	RST1	RESUM1	SUSP1	0	D1+	D1-
		Reset: 0 0 0 0 0 0 0 X X							
\$0052	USB HUB Downstream Port 2 Control Register (HDP2CR)	PEN2	LOWSP2	RST2	RESUM2	SUSP2	0	D2+	D2-
		Reset: 0 0 0 0 0 0 0 X X							
\$0053	USB HUB Downstream Port 3 Control Register (HDP3CR)	PEN3	LOWSP3	RST3	RESUM3	SUSP3	0	D3+	D3-
		Reset: 0 0 0 0 0 0 0 X X							
\$0054	USB HUB Downstream Port 4 Control Register (HDP4CR)	PEN4	LOWSP4	RST4	RESUM4	SUSP4	0	D4+	D4-
		Reset: 0 0 0 0 0 0 0 X X							
\$0055	Unimplemented	Read: [Unimplemented] Write: [Unimplemented] Reset:							
\$0056	USB SIE Timing Interrupt Register (SIETIR)	SOFF	EOF2F	EOPF	TRANF	SOFIE	EOF2IE	EOPIE	TRANIE
		Reset: 0 0 0 0 0 0 0 0							
\$0057	USB SIE Timing Status Register (SIETSR)	RSTF	0	LOCKF	0	0	0	0	0
		Reset: 0* 0 0 0 0 0 0 0							
\$0058	USB HUB Address Register (HADDR)	USBEN	ADD6	ADD5	ADD4	ADD3	ADD2	ADD1	ADD0
		Reset: 0* 0 0 0 0 0 0 0							
* RSTF and USBEN are reset by a power-on reset (POR) only.									
\$0059	USB HUB Interrupt Register 0 (HIR0)	TXDF	RXDF	0	0	TXDIE	RXDIE	0	0
		Reset: 0 0 0 0 0 0 0 0							

U = Unaffected      X = Indeterminate      [Grey Box] = Unimplemented      [R Box] = Reserved

**Figure 2-2. Control, Status, and Data Registers (Sheet 9 of 15)**

# Memory Map

Addr.	Register Name	Bit 7	6	5	4	3	2	1	Bit 0	
\$005A	Unimplemented	Read: [Unimplemented] Reset: [Unimplemented]								
\$005B	USB HUB Control Register 0 (HCR0)	TSEQ	STALL0	TXE	RXE	TPSIZ3	TPSIZ2	TPSIZ1	TPSIZ0	
\$005C	USB HUB Endpoint 1 Control and Data Register (HCDR)	STALL1	PNEW	PCHG5	PCHG4	PCHG3	PCHG2	PCHG1	PCHG0	
\$005D	USB HUB Status Register (HSR)	RSEQ	SETUP	TX1ST	0	RPSIZ3	RPSIZ2	RPSIZ1	RPSIZ0	
\$005E	USB HUB Root Port Control Register (HRPCR)	0	0	0	RESUM0	SUSPND	0	D0+	D0-	
\$005F	Unimplemented	Read: [Unimplemented] Write: [Unimplemented] Reset: [Unimplemented]								
\$0060	OSD Control Register (OSDCR)	OSDMEN	R	OSDRST	CLKINV	CLKPH1	CLKPH0	HALFCLK	OSDIEN	
\$0061	OSD Status Register (OSDSR)	WRDY	[Unimplemented]						DENDIF	[Unimplemented]
\$0062	OSD Data Register Low (OSDDRL)	OSDD7	OSDD6	OSDD5	OSDD4	OSDD3	OSDD2	OSDD1	OSDD0	
\$0063	OSD Data Register High (OSDDRH)	OSDD15	OSDD14	OSDD13	OSDD12	OSDD11	OSDD10	OSDD9	OSDD8	

U = Unaffected      X = Indeterminate      [Unimplemented] = Unimplemented      R = Reserved

**Figure 2-2. Control, Status, and Data Registers (Sheet 10 of 15)**

Addr.	Register Name	Bit 7	6	5	4	3	2	1	Bit 0	
\$0064	OSD Row Address Register (OSDRAR)	Read:				ROWA3	ROWA2	ROWA1	ROWA0	
		Write:								
		Reset:					0	0	0	0
\$0065	OSD Column Address Register (OSDCAR)	Read:			COLA4	COLA3	COLA2	COLA1	COLA0	
		Write:								
		Reset:					0	0	0	0
\$0066	OSD FLASH Even High Byte Write Buffer (OSDEHBUF)	Read:	DOT15	DOT14	DOT13	DOT12	DOT11	DOT10	DOT9	DOT8
		Write:								
		Reset:	Unaffected by reset							
\$0067	Unimplemented	Read:								
		Write:								
		Reset:								
\$0068	Port E Control Register (PECR)	Read:			R	USBDS4E	USBDS3E	USBDS2E	USBDS1E	
		Write:								
		Reset:					0	0	0	0
\$0069	Port D Control Register (PDCR)	Read:	IICDATE	IICSCLE	DDCDATE	DDCSCLE	HOUTE	VOUTE	DEE	DCLKE
		Write:								
		Reset:	0	0	0	0	0	0	0	0
\$006A	Multi-Master IIC Master Control Register (MIMCR)	Read:	MMALIF	MMNAKIF	MMBB	MMAST	MMRW	MMBR2	MMBR1	MMBR0
		Write:	0	0						
		Reset:	0	0	0	0	0	0	0	0
\$006B	Multi-Master IIC Address Register (MMADR)	Read:	MMAD7	MMAD6	MMAD5	MMAD4	MMAD3	MMAD2	MMAD1	MMEXTAD
		Write:								
		Reset:	1	0	1	0	0	0	0	0
\$006C	Multi-Master IIC Control Register (MMCR)	Read:	MMEN	MMIEN	0	0	MMTXAK	0	0	0
		Write:								
		Reset:	0	0	0	0	0	0	0	0
\$006D	Multi-Master IIC Status Register (MMSR)	Read:	MMRXIF	MMTXIF	MMATCH	MMSRW	MMRXAK	0	MMTXBE	MMRXBF
		Write:	0	0						
		Reset:	0	0	0	0	1	0	1	0

U = Unaffected      X = Indeterminate       = Unimplemented      R = Reserved

**Figure 2-2. Control, Status, and Data Registers (Sheet 11 of 15)**

# Memory Map

Addr.	Register Name	Bit 7	6	5	4	3	2	1	Bit 0	
\$006E	Multi-Master IIC Data Transmit Register (MMDTR)	Read:	MMTD7	MMTD6	MMTD5	MMTD4	MMTD3	MMTD2	MMTD1	MMTD0
		Write:								
		Reset:	1	1	1	1	1	1	1	1
\$006F	Multi-Master IIC Data Receive Register (MMDRR)	Read:	MMRD7	MMRD6	MMRD5	MMRD4	MMRD3	MMRD2	MMRD1	MMRD0
		Write:								
		Reset:	0	0	0	0	0	0	0	0
\$0070	PWM0 Data Register (0PWM)	Read:	0PWM4	0PWM3	0PWM2	0PWM1	0PWM0	0BRM2	0BRM1	0BRM0
		Write:								
		Reset:	0	0	0	0	0	0	0	0
\$0071	PWM1 Data Register (1PWM)	Read:	1PWM4	1PWM3	1PWM2	1PWM1	1PWM0	1BRM2	1BRM1	1BRM0
		Write:								
		Reset:	0	0	0	0	0	0	0	0
\$0072	PWM2 Data Register (2PWM)	Read:	2PWM4	2PWM3	2PWM2	2PWM1	2PWM0	2BRM2	2BRM1	2BRM0
		Write:								
		Reset:	0	0	0	0	0	0	0	0
\$0073	PWM3 Data Register (3PWM)	Read:	3PWM4	3PWM3	3PWM2	3PWM1	3PWM0	3BRM2	3BRM1	3BRM0
		Write:								
		Reset:	0	0	0	0	0	0	0	0
\$0074	PWM4 Data Register (4PWM)	Read:	4PWM4	4PWM3	4PWM2	4PWM1	4PWM0	4BRM2	4BRM1	4BRM0
		Write:								
		Reset:	0	0	0	0	0	0	0	0
\$0075	PWM5 Data Register (5PWM)	Read:	5PWM4	5PWM3	5PWM2	5PWM1	5PWM0	5BRM2	5BRM1	5BRM0
		Write:								
		Reset:	0	0	0	0	0	0	0	0
\$0076	PWM6 Data Register (6PWM)	Read:	6PWM4	6PWM3	6PWM2	6PWM1	6PWM0	6BRM2	6BRM1	6BRM0
		Write:								
		Reset:	0	0	0	0	0	0	0	0
\$0077	PWM7 Data Register (7PWM)	Read:	7PWM4	7PWM3	7PWM2	7PWM1	7PWM0	7BRM2	7BRM1	7BRM0
		Write:								
		Reset:	0	0	0	0	0	0	0	0

U = Unaffected      X = Indeterminate       = Unimplemented      R = Reserved

**Figure 2-2. Control, Status, and Data Registers (Sheet 12 of 15)**



Addr.	Register Name	Bit 7	6	5	4	3	2	1	Bit 0	
\$0078	PWM Control Register (PWMCR)	Read:	PWM7E	PWM6E	PWM5E	PWM4E	PWM3E	PWM2E	PWM1E	PWM0E
		Write:								
		Reset:	0	0	0	0	0	0	0	0
\$0079	Unimplemented	Read:								
		Write:								
		Reset:								
\$007A	Unimplemented	Read:								
		Write:								
		Reset:								
\$007B	Unimplemented	Read:								
		Write:								
		Reset:								
\$007C	Unimplemented	Read:								
		Write:								
		Reset:								
\$007D	Unimplemented	Read:								
		Write:								
		Reset:								
\$007E	Unimplemented	Read:								
		Write:								
		Reset:								
\$007F	Unimplemented	Read:								
		Write:								
		Reset:								
\$FE00	SIM Break Status Register (SBSR)	Read:	R	R	R	R	R	SBSW	R	
		Write:						Note		
		Reset:						0		

Note: Writing a logic 0 clears SBSW.

U = Unaffected      X = Indeterminate       = Unimplemented      R = Reserved

**Figure 2-2. Control, Status, and Data Registers (Sheet 13 of 15)**

# Memory Map

Addr.	Register Name	Bit 7	6	5	4	3	2	1	Bit 0	
\$FE01	SIM Reset Status Register (SRSR)	Read:	POR	PIN	COP	ILOP	ILAD	USB	0	0
		Write:								
		POR:	1	0	0	0	0	0	0	0
\$FE02	Reserved	Read:	R	R	R	R	R	R	R	R
		Write:								
		Reset:								
\$FE03	SIM Break Flag Control Register (SBFCR)	Read:	BCFE	R	R	R	R	R	R	R
		Write:								
		Reset:	0							
\$FE04	Interrupt Status Register 1 (INT1)	Read:	IF6	IF5	IF4	IF3	IF2	IF1	0	0
		Write:	R	R	R	R	R	R	R	R
		Reset:	0	0	0	0	0	0	0	0
\$FE05	Interrupt Status Register 2 (INT2)	Read:	IF14	IF13	IF12	IF11	IF10	IF9	IF8	IF7
		Write:	R	R	R	R	R	R	R	R
		Reset:	0	0	0	0	0	0	0	0
\$FE06	Reserved	Read:	R	R	R	R	R	R	R	R
		Write:								
		Reset:								
\$FE07	47,616 Bytes FLASH Control Register (FLCR)	Read:	0	0	0	0	HVEN	MASS	ERASE	PGM
		Write:								
		Reset:	0	0	0	0	0	0	0	0
\$FE08	47,616 Bytes FLASH Block Protect Register (FLBPR)	Read:	BPR7	BPR6	BPR5	BPR4	BPR3	BPR2	BPR1	0
		Write:								
		Reset:	0	0	0	0	0	0	0	0
\$FE09	Reserved	Read:	R	R	R	R	R	R	R	R
		Write:								
		Reset:								
\$FE0A	13K-Bytes FLASH Control Register (FLCR1)	Read:	0	0	0	0	HVEN1	MASS1	ERASE1	PGM1
		Write:								
		Reset:	0	0	0	0	0	0	0	0

U = Unaffected      X = Indeterminate       = Unimplemented      R = Reserved

**Figure 2-2. Control, Status, and Data Registers (Sheet 14 of 15)**

Addr.	Register Name		Bit 7	6	5	4	3	2	1	Bit 0	
\$FE0B	13K-Bytes FLASH Block Protect Register (FLBPR1)	Read:								0	
		Write:	BPR17	BPR16	BPR15	BPR14	BPR13	BPR12	BPR11		
		Reset:	0	0	0	0	0	0	0	0	0
\$FE0C	Break Address High Register (BRKH)	Read:									
		Write:	Bit 15	14	13	12	11	10	9	Bit 8	
		Reset:	0	0	0	0	0	0	0	0	0
\$FE0D	Break Address Low Register (BRKL)	Read:	Bit 7	6	5	4	3	2	1	Bit 0	
		Write:									
		Reset:	0	0	0	0	0	0	0	0	0
\$FE0E	Break Status and Control Register (BRKSCR)	Read:	BRKE	BRKA	0	0	0	0	0	0	
		Write:									
		Reset:	0	0	0	0	0	0	0	0	0
\$FFFF	COP Control Register (COPCTL)	Read:	Low byte of reset vector								
		Write:	Writing clears COP counter (any value)								
		Reset:	Unaffected by reset								

U = Unaffected      X = Indeterminate       = Unimplemented      R = Reserved

**Figure 2-2. Control, Status, and Data Registers (Sheet 15 of 15)**

**Table 2-1. Vector Addresses**

Vector Priority	Vector	Address	Vector
Lowest  Highest	IF14	\$FFE0	CGM PLL Interrupt Vector (High)
		\$FFE1	CGM PLL Interrupt Vector (Low)
	IF13	\$FFE2	Keyboard Interrupt Vector (High)
		\$FFE3	Keyboard Interrupt Vector (Low)
	IF12	\$FFE4	ADC Interrupt Vector (High)
		\$FFE5	ADC Interrupt Vector (Low)
	IF11	\$FFE6	OSD Interrupt Vector (High)
		\$FFE7	OSD Interrupt Vector (Low)
	IF10	\$FFE8	MMIIC Vector (High)
		\$FFE9	MMIIC Vector (Low)
	IF9	\$FFEA	Sync Processor Vector (High)
		\$FFEB	Sync Processor Vector (Low)
	IF8	\$FFEC	TIM Overflow Vector (High)
		\$FFED	TIM Overflow Vector (Low)
	IF7	\$FFEE	TIM Channel 1 Vector (High)
		\$FFEF	TIM Channel 1 Vector (Low)
	IF6	\$FFF0	TIM Channel 0 Vector (High)
		\$FFF1	TIM Channel 0 Vector (Low)
	IF5	\$FFF2	DDC12AB Vector (High)
		\$FFF3	DDC12AB Vector (Low)
	IF4	\$FFF4	USB Device Interrupt Vector (High)
		\$FFF5	USB Device Interrupt Vector (Low)
	IF3	\$FFF6	USB HUB Interrupt Vector (High)
		\$FFF7	USB HUB Interrupt Vector (Low)
	IF2	\$FFF8	USB Vector (High)
		\$FFF9	USB Vector (Low)
	IF1	\$FFFA	IRQ Vector (High)
		\$FFFB	IRQ Vector (Low)
—	\$FFFC	SWI Vector (High)	
	\$FFFD	SWI Vector (Low)	
—	\$FFFE	Reset Vector (High)	
	\$FFFF	Reset Vector (Low)	

## Section 3. Random-Access Memory (RAM)

### 3.1 Contents

3.2	Introduction . . . . .	61
3.3	Functional Description . . . . .	61

### 3.2 Introduction

This section describes the 2,048 bytes of RAM (random-access memory).

### 3.3 Functional Description

The RAM is divided into two blocks. Addresses \$0080 through \$047F are locations for general use. Addresses \$0800 through \$0BFF are locations for the OSD display RAM (see [18.6 OSD Screen Memory Map](#)). The location of the stack RAM is programmable. The 16-bit stack pointer allows the stack to be anywhere in the 64-Kbyte memory space.

**NOTE:** *For correct operation, the stack pointer must point only to RAM locations.*

Within page zero are 128 bytes of RAM. Because the location of the stack RAM is programmable, all page zero RAM locations can be used for I/O control and user data or code. When the stack pointer is moved from its reset location at \$00FF out of page zero, direct addressing mode instructions can efficiently access all page zero RAM locations. Page zero RAM, therefore, provides ideal locations for frequently accessed global variables.

Before processing an interrupt, the CPU uses five bytes of the stack to save the contents of the CPU registers.

## Random-Access Memory (RAM)

**NOTE:** *For M6805 compatibility, the H register is not stacked.*

During a subroutine call, the CPU uses two bytes of the stack to store the return address. The stack pointer decrements during pushes and increments during pulls.

**NOTE:** *Be careful when using nested subroutines. The CPU may overwrite data in the RAM during a subroutine or during the interrupt stacking operation.*

## Section 4. FLASH Memory

### 4.1 Contents

4.2	Introduction . . . . .	64
4.3	Functional Description . . . . .	64
4.4	FLASH Control Registers . . . . .	66
4.4.1	OSD FLASH Even High Byte Write Buffer (OSDEHBUF) . .	67
4.5	FLASH Block Erase Operation . . . . .	68
4.6	FLASH Mass Erase Operation . . . . .	69
4.7	FLASH Program Operation. . . . .	70
4.8	FLASH Block Protection . . . . .	72
4.8.1	FLASH Block Protect Registers . . . . .	72

## 4.2 Introduction

This section describes the operation of the embedded FLASH memory. This memory can be read, programmed, and erased from a single external supply. The program and erase operations are enabled through the use of an internal charge pump.

Addr.	Register Name		Bit 7	6	5	4	3	2	1	Bit 0
\$FE07	47,616 Bytes FLASH Control Register (FLCR)	Read:	0	0	0	0	HVEN	MASS	ERASE	PGM
		Write:								
		Reset:	0	0	0	0	0	0	0	0
\$FE08	47,616 Bytes FLASH Block Protect Register (FLBPR)	Read:	BPR7	BPR6	BPR5	BPR4	BPR3	BPR2	BPR1	0
		Write:								
		Reset:	0	0	0	0	0	0	0	0
\$FE0A	13K-Bytes FLASH Control Register (FLCR1)	Read:	0	0	0	0	HVEN1	MASS1	ERASE1	PGM1
		Write:								
		Reset:	0	0	0	0	0	0	0	0
\$FE0B	13K-Bytes FLASH Block Protect Register (FLBPR1)	Read:	BPR17	BPR16	BPR15	BPR14	BPR13	BPR12	BPR11	0
		Write:								
		Reset:	0	0	0	0	0	0	0	0
\$0066	OSD FLASH Even High Byte Write Buffer (OSDEHBUF)	Read:	DOT15	DOT14	DOT13	DOT12	DOT11	DOT10	DOT9	DOT8
		Write:								
		Reset:	Unaffected by reset							

**Figure 4-1. FLASH I/O Register Summary**

## 4.3 Functional Description

The MC68HC908LD64 FLASH memory contains two arrays:

- 13,312-byte array
- 47,616-byte array

An additional 32 bytes of FLASH user vectors, \$FFE0–\$FFFF, are in the same array as the 47,616-byte. The size, address range, and memory usage of the arrays are summarized in [Table 4-1](#).

**NOTE:** An erased bit reads as logic 1 and a programmed bit reads as logic 0.



**Table 4-1. FLASH Memory Array Summary**

	13,312 Array		47,616 Array		
	Bytes	1,024	12,288	47,616	32
<b>Address range</b>	\$0C00–\$0FFF	\$1000–\$3FFF	\$4000–\$F9FF	\$FFE0–\$FFFF	
<b>Minimum erase size</b>	128 bytes	512 bytes	512 bytes	32 bytes by mass erase only	
<b>Usage</b>	User data or program	OSD fonts	User program	User vectors	
<b>Programming Size</b>	Double bytes in a 64-byte programming routine		Single bytes in a 64-byte programming routine		
<b>Related Control registers</b>	FLCR1 at \$FE0A FLBPR1 at \$FE0B OSDEHBUF at \$0066		FLCR at \$FE07 FLBPR at \$FE08		

Each FLASH array is programmed and erased through control bits in their respective memory mapped FLASH control registers, FLCR and FLCR1.

The 13K-bytes array is programmed in double bytes. Programming an odd address (\$xxxx+1) location automatically programs the content in the OSD FLASH even high byte write buffer (OSDEHBUF) to the even address (\$xxxx) location.

Programming tools are available from Freescale. Contact your local Freescale representative for more information.

**NOTE:** *A security feature prevents viewing of the FLASH contents.<sup>1</sup>*

1. No security feature is absolutely secure. However, Freescale's strategy is to make reading or copying the FLASH difficult for unauthorized users.

## 4.4 FLASH Control Registers

The two FLASH control registers control FLASH program and erase operations.

This register controls the 47,616-byte array:

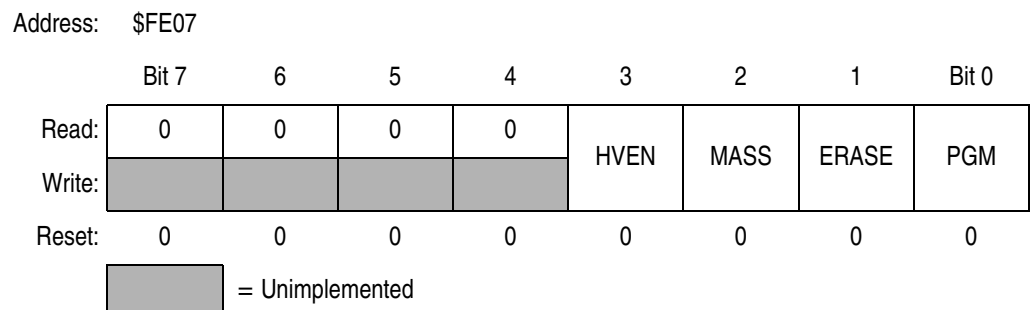

**Figure 4-2. 47,616-byte FLASH Control Register (FLCR)**

This register controls the 13K-byte array:



**Figure 4-3. 13K-byte FLASH Control Register (FLCR1)**

FLCR1 is used with the OSD FLASH even high byte write buffer (OSDEHBUF) in programming operations. See [4.4.1 OSD FLASH Even High Byte Write Buffer \(OSDEHBUF\)](#).

The following are bit definitions for FLCR and FLCR1.

**HVEN** — High-Voltage Enable Bit

This read/write bit enables the charge pump to drive high voltages for program and erase operations in the array. HVEN can only be set if either PGM = 1 or ERASE = 1 and the proper sequence for program or erase is followed.

- 1 = High voltage enabled to array and charge pump on
- 0 = High voltage disabled to array and charge pump off

**MASS — Mass Erase Control Bit**

This read/write bit configures the memory for mass erase operation or block erase operation when the ERASE bit is set.

- 1 = Mass Erase operation selected
- 0 = Mass Erase operation not selected

**ERASE — Erase Control Bit**

This read/write bit configures the memory for erase operation. ERASE is interlocked with the PGM bit such that both bits cannot be equal to 1 or set to 1 at the same time.

- 1 = Erase operation selected
- 0 = Erase operation not selected

**PGM — Program Control Bit**

This read/write bit configures the memory for program operation. PGM is interlocked with the ERASE bit such that both bits cannot be equal to 1 or set to 1 at the same time.

- 1 = Program operation selected
- 0 = Program operation not selected

**4.4.1 OSD FLASH Even High Byte Write Buffer (OSDEHBUF)**

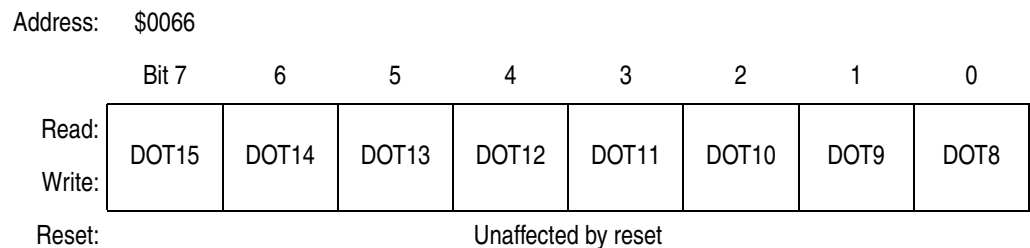

**Figure 4-4. OSD FLASH Even High Byte Write Buffer (OSDEHBUF)**

**DOT[15:8] — OSD FLASH Even High Byte Buffer**

These bits define the byte to be programmed to an even address location of the 13K-bytes array. The contents of this register will be automatically programmed to the even address (\$xxxx) location when the odd address (\$xxxx+1) is programmed. Reset has no effect on these bits. See [18.5 OSD FLASH Font Memory Map](#) for OSD font memory map.

## 4.5 FLASH Block Erase Operation

The minimum erase size for the FLASH memory is one block, and is carried out by the block erase operation. For memory \$0C00–\$0FFF, a block consists of 128 consecutive bytes starting from addresses \$xx00 or \$xx80. For memory \$1000–\$3FFF and \$4000–\$F9FF, a block consists of 512 consecutive bytes starting from addresses \$x000, \$x200, \$x400, \$x600, \$x800, \$xA00, \$xC00, or \$xE00.

**NOTE:** *The 32-byte user vectors, \$FFE0–\$FFFF, cannot be erased by the block erase operation because of security reasons. Mass erase is required to erase this block.*

Use the following procedure to erase a block of FLASH memory:

1. Set the ERASE bit, and clear the MASS bit in the FLASH control register.
2. Write any data to any FLASH address within the block address range desired.
3. Wait for a time,  $t_{nvs}$  (min. 5 $\mu$ s)
4. Set the HVEN bit.
5. Wait for a time,  $t_{Erase}$  (min. 10ms)
6. Clear the ERASE bit.
7. Wait for a time,  $t_{nvh}$  (min. 5 $\mu$ s)
8. Clear the HVEN bit.
9. After a time,  $t_{rcv}$  (min. 1 $\mu$ s), the memory can be accessed again in read mode.

**NOTE:** *Programming and erasing of FLASH locations cannot be performed by code being executed from the same FLASH array that is being programmed or erased. While these operations must be performed in the order as shown, but other unrelated operations may occur between the steps.*

## 4.6 FLASH Mass Erase Operation

A mass erase operation erases an entire array of FLASH memory. The MC68HC908LD64 contains two FLASH memory arrays, therefore, two mass erase operations are required to erase all FLASH memory in the device. Mass erasing the 13K-byte array, erases all FLASH memory from \$0800 to \$3FFF. Mass erasing the 47,616-byte array, erases all FLASH memory from \$4000 to \$FFFF.

Use the following procedure to erase an entire FLASH memory array:

1. Set both the ERASE bit, and the MASS bit in the FLASH control register.
2. Write any data to any FLASH address within the FLASH memory address range.
3. Wait for a time,  $t_{nvs}$  (5 $\mu$ s).
4. Set the HVEN bit.
5. Wait for a time,  $t_{ERASE}$  (10ms).
6. Clear the ERASE bit.
7. Wait for a time,  $t_{nvhl}$  (100 $\mu$ s).
8. Clear the HVEN bit.
9. After time,  $t_{rcv}$  (1 $\mu$ s), the memory can be accessed again in read mode.

**NOTE:** *Programming and erasing of FLASH locations cannot be performed by code being executed from the same FLASH array that is being programmed or erased. While these operations must be performed in the order as shown, but other unrelated operations may occur between the steps.*

## 4.7 FLASH Program Operation

Programming of the FLASH memory is done on a row basis. A row consists of 64 consecutive bytes starting from addresses \$XX00, \$XX40, \$XX80, and \$XXC0. Use this step-by-step procedure to program a row of FLASH memory ([Figure 4-5](#) is a flowchart representation):

**NOTE:** *In order to avoid program disturbs, the row must be erased before any byte on that row is programmed.*

1. Set the PGM bit. This configures the memory for program operation and enables the latching of address and data for programming.
2. Write any data to any FLASH address within the row address range desired.
3. Wait for a time,  $t_{nvs}$  (min. 5 $\mu$ s).
4. Set the HVEN bit.
5. Wait for a time,  $t_{pgs}$  (min. 10 $\mu$ s).
6. For 47,616-byte array: Write data to the FLASH address to be programmed.  
For 13K-byte array: Write even address data to OSDEHBUF then write odd address data to the odd FLASH address to be programmed.
7. Wait for time,  $t_{PROG}$  (min. 20 $\mu$ s).
8. Repeat step 6 and 7 until all the bytes within the row are programmed.
9. Clear the PGM bit.
10. Wait for time,  $t_{nvh}$  (min. 5 $\mu$ s).
11. Clear the HVEN bit.
12. After time,  $t_{rcv}$  (min 1 $\mu$ s), the memory can be accessed in read mode again.

This program sequence is repeated throughout the memory until all data is programmed.

**NOTE:** *Programming and erasing of FLASH locations cannot be performed by code being executed from the same FLASH array that is being programmed or erased. While these operations must be performed in the order shown, other unrelated operations may occur between the steps. Do not exceed  $t_{PROG}$  maximum. See [24.14 FLASH Memory Characteristics](#).*

**Algorithm for programming  
a row (64 bytes) of FLASH memory**

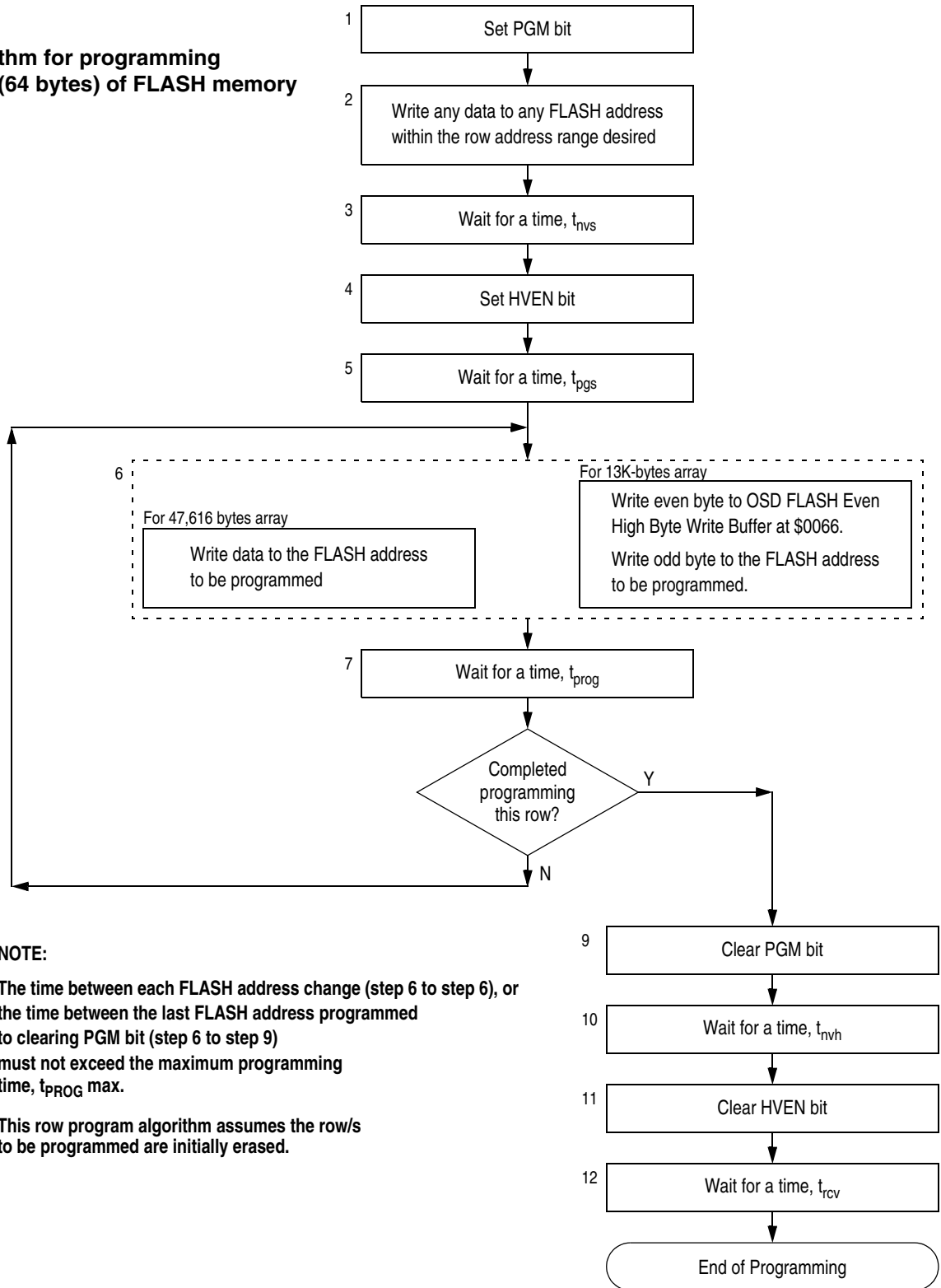

**NOTE:**

The time between each FLASH address change (step 6 to step 6), or the time between the last FLASH address programmed to clearing PGM bit (step 6 to step 9) must not exceed the maximum programming time,  $t_{PROG\ max}$ .

This row program algorithm assumes the row/s to be programmed are initially erased.

**Figure 4-5. FLASH Programming Flowchart**

## 4.8 FLASH Block Protection

Due to the ability of the on-board charge pump to erase and program the FLASH memory in the target application, provision is made for protecting blocks of memory from unintentional erase or program operations due to system malfunction. This protection is done by use of a FLASH Block Protect Register for each array (FLBPR and FLBPR1). The block protect register determines the range of the FLASH memory which is to be protected. The range of the protected area starts from a location defined by block protect register and ends at the bottom of the FLASH memory array (\$FFFF and \$3FFF). When the memory is protected, the HVEN bit cannot be set in either ERASE or PROGRAM operations.

### 4.8.1 FLASH Block Protect Registers

Each FLASH block protect register is implemented as an 7-bit I/O register. The BPR bit content of the register determines the starting location of the protected range within the FLASH memory.

This register controls the 47,616-byte array:

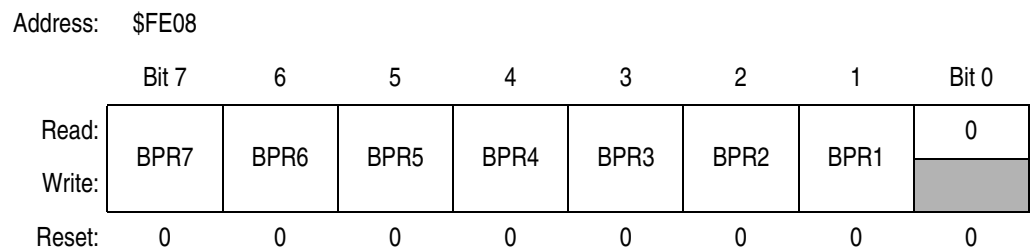

**Figure 4-6. 47,616-byte FLASH Block Protect Register (FLBPR)**

This register controls the 13K-byte array:

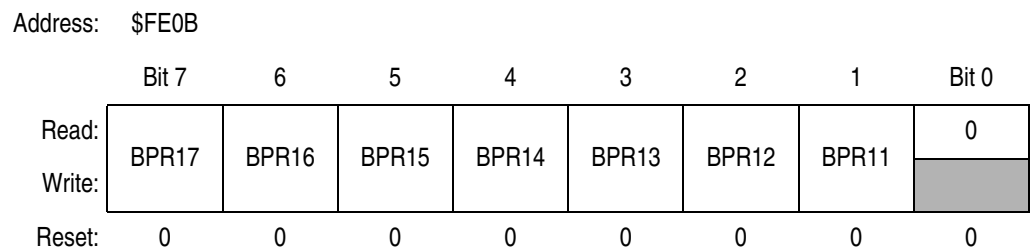

**Figure 4-7. 13K-byte FLASH Block Protect Register 1 (FLBPR1)**



**BPR[7:1] — FLASH Block Protect Bits**

These seven bits represent bits [15:9] of a 16-bit memory address. Bits [8:0] are logic 0s.

The resultant 16-bit address is used for specifying the start address of the FLASH memory for block protection. The FLASH is protected from this start address to the end of FLASH memory, at \$FFFF.

**BPR1[7:1] — FLASH Block Protect Bits**

These seven bits represent bits [15:9] of a 16-bit memory address. Bits [8:0] are logic 0s.

The resultant 16-bit address is used for specifying the start address of the FLASH memory for block protection. The FLASH is protected from this start address to the end of FLASH memory, at \$3FFF.

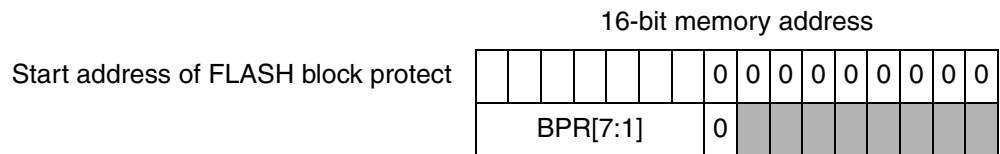

**Figure 4-8. FLASH Block Protect Start Address**

Examples of block protection for 47,616-byte FLASH memory array:

BPR[7:0]	FLASH Memory Protected Range
\$40	The entire 47,616 bytes of FLASH memory is <b>protected</b> .
\$42 (0100 0010)	\$4200 (0100 0010 0000 0000) to \$FFFF
\$44 (0100 0100)	\$4400 (0100 0100 0000 0000) to \$FFFF
and so on...	
\$F8 (1111 1000)	\$F800 (1111 1000 0000 0000) to \$FFFF
\$FA	\$FFE0 to \$FFFF (FLASH Vectors)
\$FC	\$FFE0 to \$FFFF (FLASH Vectors)
\$FE	\$FFE0 to \$FFFF (FLASH Vectors)
\$00–3E	The entire 47,616 bytes FLASH memory is <b>not protected</b> .

Examples of block protection for 13K-byte FLASH memory array:

BPR1[7:0]	FLASH Memory Protected Range
\$0C	The entire 13K-byte FLASH memory is <b>protected</b> .
\$0E (0000 1110)	\$0E00 (0000 1110 0000 0000) to \$3FFF
\$10 (0001 0000)	\$1000 (0001 0000 0000 0000) to \$3FFF
and so on...	
\$38 (0011 1000)	\$3800 (0011 1000 0000 0000) to \$3FFF
\$3A (0011 1010)	\$3A00 (0011 1010 0000 0000) to \$3FFF
\$3C (0011 1100)	\$3C00 (0011 1100 0000 0000) to \$3FFF
\$3E (0011 1110)	\$3E00 (0011 1110 0000 0000) to \$3FFF
\$00–\$0B or \$40–\$FE	The entire 13K-byte FLASH memory is <b>not protected</b> .

## Section 5. Configuration Register (CONFIG)

### 5.1 Contents

5.2	Introduction . . . . .	75
5.3	Functional Description . . . . .	75
5.4	Configuration Register . . . . .	76

### 5.2 Introduction

This section describes the configuration register, CONFIG. The configuration register enables or disables these options:

- Stop mode recovery time (32 OSCXCLK cycles or 4096 OSCXCLK cycles)
- COP timeout period ( $2^{18} - 2^4$  or  $2^{13} - 2^4$  OSCXCLK cycles)
- STOP instruction
- Computer operating properly module (COP)

### 5.3 Functional Description

The configuration register is used in the initialization of various options. The configuration register can be written once after each reset. All of the configuration register bits are cleared during reset. Since the various options affect the operation of the MCU, it is recommended that this register be written immediately after reset. The configuration register is located at \$001F. The configuration register may be read at anytime.

## 5.4 Configuration Register

Address: \$001F

	Bit 7	6	5	4	3	2	1	Bit 0
Read:	0	0	0	0	SSREC	COPRS	STOP	COPD
Write:								
Reset:	0	0	0	0	0	0	0	0

= Unimplemented

**Figure 5-1. Configuration Register (CONFIG)**

### SSREC — Short Stop Recovery Bit

SSREC enables the CPU to exit stop mode with a delay of 32 OSCXCLK cycles instead of a 4096 OSCXCLK cycle delay.

- 1 = Stop mode recovery after 32 OSCXCLK cycles
- 0 = Stop mode recovery after 4096 OSCXCLK cycles

**NOTE:** *Exiting stop mode by pulling reset will result in the long stop recovery.*

*If using an external crystal oscillator, do not set the SSREC bit.*

### COPRS — COP Rate Select Bit

COPRS selects the COP timeout period. Reset clears COPRS. (See [Section 22. Computer Operating Properly \(COP\)](#).)

- 1 = COP timeout period =  $2^{13} - 2^4$  OSCXCLK cycles
- 0 = COP timeout period =  $2^{18} - 2^4$  OSCXCLK cycles

### STOP — STOP Instruction Enable Bit

STOP enables the STOP instruction.

- 1 = STOP instruction enabled
- 0 = STOP instruction treated as illegal opcode

### COPD — COP Disable Bit

COPD disables the COP module. (See [Section 22. Computer Operating Properly \(COP\)](#).)

- 1 = COP module disabled
- 0 = COP module enabled

## Section 6. Central Processor Unit (CPU)

### 6.1 Contents

6.2	Introduction . . . . .	78
6.3	Features . . . . .	78
6.4	CPU Registers . . . . .	79
6.4.1	Accumulator . . . . .	79
6.4.2	Index Register . . . . .	80
6.4.3	Stack Pointer . . . . .	80
6.4.4	Program Counter . . . . .	81
6.4.5	Condition Code Register . . . . .	82
6.5	Arithmetic/Logic Unit (ALU) . . . . .	84
6.6	Low-Power Modes . . . . .	84
6.6.1	Wait Mode . . . . .	84
6.6.2	Stop Mode . . . . .	85
6.7	CPU During Break Interrupts . . . . .	85
6.8	Instruction Set Summary . . . . .	85
6.9	Opcode Map . . . . .	85

## 6.2 Introduction

The M68HC08 CPU (central processor unit) is an enhanced and fully object-code-compatible version of the M68HC05 CPU. The *CPU08 Reference Manual* (Freescale document order number CPU08RM/AD) contains a description of the CPU instruction set, addressing modes, and architecture.

## 6.3 Features

Feature of the CPU include:

- Object code fully upward-compatible with M68HC05 Family
- 16-bit stack pointer with stack manipulation instructions
- 16-Bit index register with X-register manipulation instructions
- 6-MHz CPU internal bus frequency
- 64-Kbyte program/data memory space
- 16 addressing modes
- Memory-to-memory data moves without using accumulator
- Fast 8-bit by 8-bit multiply and 16-bit by 8-bit divide instructions
- Enhanced binary-coded decimal (BCD) data handling
- Modular architecture with expandable internal bus definition for extension of addressing range beyond 64-Kbytes
- Low-power stop and wait modes

### 6.4 CPU Registers

Figure 6-1 shows the five CPU registers. CPU registers are not part of the memory map.

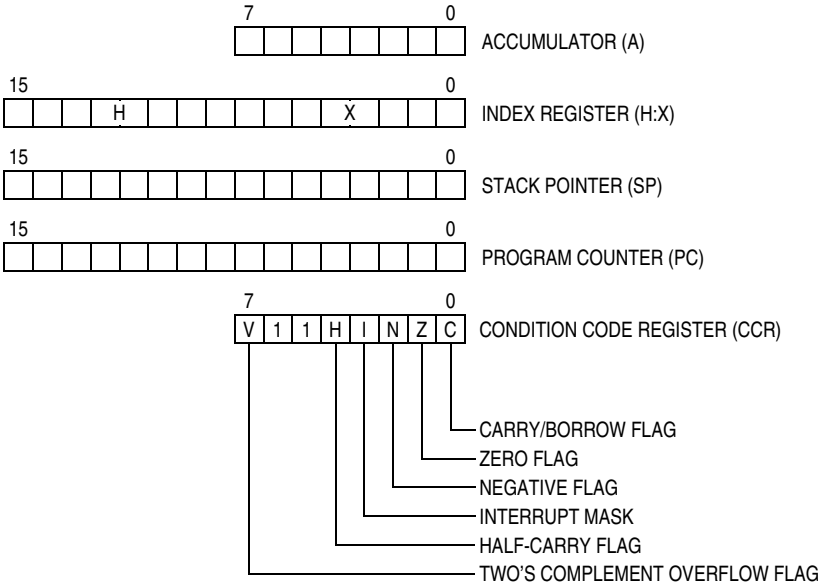

Figure 6-1. CPU Registers

#### 6.4.1 Accumulator

The accumulator is a general-purpose 8-bit register. The CPU uses the accumulator to hold operands and the results of arithmetic/logic operations.

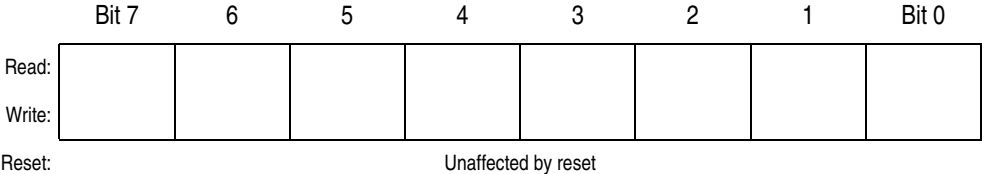

Figure 6-2. Accumulator (A)

Downloaded from [Elcodis.com](http://Elcodis.com) electronic components distributor

## 6.4.2 Index Register

The 16-bit index register allows indexed addressing of a 64K-byte memory space. H is the upper byte of the index register, and X is the lower byte. H:X is the concatenated 16-bit index register.

In the indexed addressing modes, the CPU uses the contents of the index register to determine the conditional address of the operand.

The index register can serve also as a temporary data storage location.

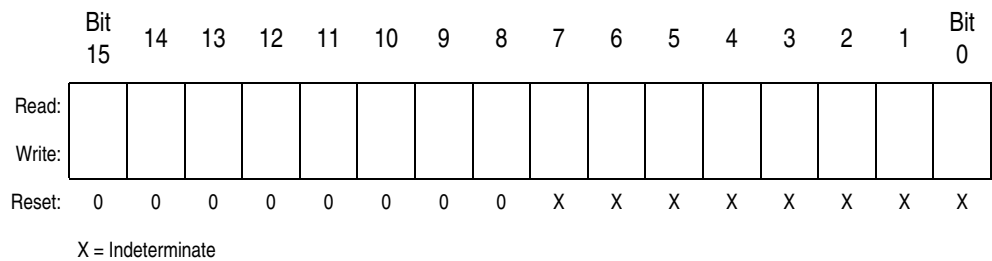
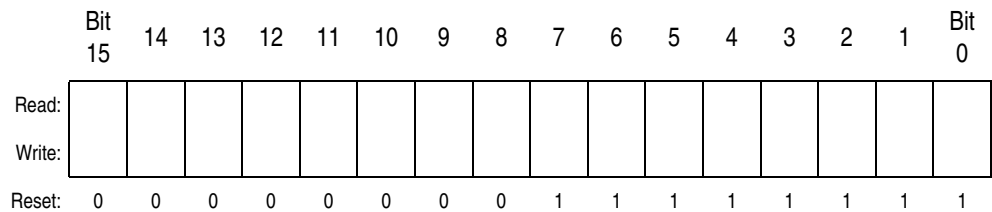

**Figure 6-3. Index Register (H:X)**

## 6.4.3 Stack Pointer

The stack pointer is a 16-bit register that contains the address of the next location on the stack. During a reset, the stack pointer is preset to \$00FF. The reset stack pointer (RSP) instruction sets the least significant byte to \$FF and does not affect the most significant byte. The stack pointer decrements as data is pushed onto the stack and increments as data is pulled from the stack.

In the stack pointer 8-bit offset and 16-bit offset addressing modes, the stack pointer can function as an index register to access data on the stack. The CPU uses the contents of the stack pointer to determine the conditional address of the operand.



**Figure 6-4. Stack Pointer (SP)**



**NOTE:** *The location of the stack is arbitrary and may be relocated anywhere in RAM. Moving the SP out of page 0 (\$0000 to \$00FF) frees direct address (page 0) space. For correct operation, the stack pointer must point only to RAM locations.*

### 6.4.4 Program Counter

The program counter is a 16-bit register that contains the address of the next instruction or operand to be fetched.

Normally, the program counter automatically increments to the next sequential memory location every time an instruction or operand is fetched. Jump, branch, and interrupt operations load the program counter with an address other than that of the next sequential location.

During reset, the program counter is loaded with the reset vector address located at \$FFFE and \$FFFF. The vector address is the address of the first instruction to be executed after exiting the reset state.

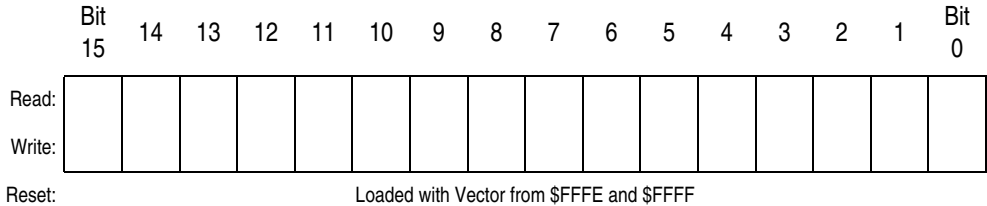

**Figure 6-5. Program Counter (PC)**

## 6.4.5 Condition Code Register

The 8-bit condition code register contains the interrupt mask and five flags that indicate the results of the instruction just executed. Bits 6 and 5 are set permanently to logic 1. The following paragraphs describe the functions of the condition code register.

	Bit 7	6	5	4	3	2	1	Bit 0
Read:	V	1	1	H	I	N	Z	C
Write:								
Reset:	X	1	1	X	1	X	X	X

X = Indeterminate

**Figure 6-6. Condition Code Register (CCR)**

### V — Overflow Flag

The CPU sets the overflow flag when a two's complement overflow occurs. The signed branch instructions BGT, BGE, BLE, and BLT use the overflow flag.

- 1 = Overflow
- 0 = No overflow

### H — Half-Carry Flag

The CPU sets the half-carry flag when a carry occurs between accumulator bits 3 and 4 during an add-without-carry (ADD) or add-with-carry (ADC) operation. The half-carry flag is required for binary-coded decimal (BCD) arithmetic operations. The DAA instruction uses the states of the H and C flags to determine the appropriate correction factor.

- 1 = Carry between bits 3 and 4
- 0 = No carry between bits 3 and 4

### I — Interrupt Mask

When the interrupt mask is set, all maskable CPU interrupts are disabled. CPU interrupts are enabled when the interrupt mask is cleared. When a CPU interrupt occurs, the interrupt mask is set automatically after the CPU registers are saved on the stack, but before the interrupt vector is fetched.

1 = Interrupts disabled

0 = Interrupts enabled

**NOTE:** *To maintain M6805 Family compatibility, the upper byte of the index register (H) is not stacked automatically. If the interrupt service routine modifies H, then the user must stack and unstack H using the PSHH and PULH instructions.*

After the I bit is cleared, the highest-priority interrupt request is serviced first.

A return-from-interrupt (RTI) instruction pulls the CPU registers from the stack and restores the interrupt mask from the stack. After any reset, the interrupt mask is set and can be cleared only by the clear interrupt mask software instruction (CLI).

### N — Negative Flag

The CPU sets the negative flag when an arithmetic operation, logic operation, or data manipulation produces a negative result, setting bit 7 of the result.

1 = Negative result

0 = Non-negative result

### Z — Zero Flag

The CPU sets the zero flag when an arithmetic operation, logic operation, or data manipulation produces a result of \$00.

1 = Zero result

0 = Non-zero result

### C — Carry/Borrow Flag

The CPU sets the carry/borrow flag when an addition operation produces a carry out of bit 7 of the accumulator or when a subtraction operation requires a borrow. Some instructions — such as bit test and branch, shift, and rotate — also clear or set the carry/borrow flag.

1 = Carry out of bit 7

0 = No carry out of bit 7

## 6.5 Arithmetic/Logic Unit (ALU)

The ALU performs the arithmetic and logic operations defined by the instruction set.

Refer to the *CPU08 Reference Manual* (Freescale document order number CPU08RM/AD) for a description of the instructions and addressing modes and more detail about the architecture of the CPU.

## 6.6 Low-Power Modes

The WAIT and STOP instructions put the MCU in low power-consumption standby modes.

### 6.6.1 Wait Mode

The WAIT instruction:

- Clears the interrupt mask (I bit) in the condition code register, enabling interrupts. After exit from wait mode by interrupt, the I bit remains clear. After exit by reset, the I bit is set.
- Disables the CPU clock.

## 6.6.2 Stop Mode

The STOP instruction:

- Clears the interrupt mask (I bit) in the condition code register, enabling external interrupts. After exit from stop mode by external interrupt, the I bit remains clear. After exit by reset, the I bit is set.
- Disables the CPU clock.

After exiting stop mode, the CPU clock begins running after the oscillator stabilization delay.

## 6.7 CPU During Break Interrupts

If the break module is enabled, a break interrupt causes the CPU to execute the software interrupt instruction (SWI) at the completion of the current CPU instruction. (See [Section 23. Break Module \(BRK\)](#).) The program counter vectors to \$FFFC–\$FFFD (\$FEFC–\$FEFD in monitor mode).

A return-from-interrupt instruction (RTI) in the break routine ends the break interrupt and returns the MCU to normal operation if the break interrupt has been deasserted.

## 6.8 Instruction Set Summary

[Table 6-1](#) provides a summary of the M68HC08 instruction set.

## 6.9 Opcode Map

The opcode map is provided in [Table 6-2](#).

## Table 6-1. Instruction Set Summary (Sheet 1 of 8)

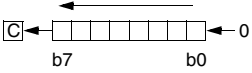
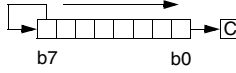
Source Form	Operation	Description	Effect on CCR						Address Mode	Opcode	Operand	Cycles
			V	H	I	N	Z	C				
ADC #opr ADC opr ADC opr ADC opr,X ADC opr,X ADC ,X ADC opr,SP ADC opr,SP	Add with Carry	$A \leftarrow (A) + (M) + (C)$	↕	↕	–	↕	↕	↕	IMM DIR EXT IX2 IX1 IX SP1 SP2	A9 B9 C9 D9 E9 F9 9EE9 9ED9	ii dd hh ll ee ff ff ff ff ff ee ff	2 3 4 4 3 2 4 5
ADD #opr ADD opr ADD opr ADD opr,X ADD opr,X ADD ,X ADD opr,SP ADD opr,SP	Add without Carry	$A \leftarrow (A) + (M)$	↕	↕	–	↕	↕	↕	IMM DIR EXT IX2 IX1 IX SP1 SP2	AB BB CB DB EB FB 9EEB 9EDB	ii dd hh ll ee ff ff ff ff ee ff	2 3 4 4 3 2 4 5
AIS #opr	Add Immediate Value (Signed) to SP	$SP \leftarrow (SP) + (16 \ll M)$	–	–	–	–	–	–	IMM	A7	ii	2
AIX #opr	Add Immediate Value (Signed) to H:X	$H:X \leftarrow (H:X) + (16 \ll M)$	–	–	–	–	–	–	IMM	AF	ii	2
AND #opr AND opr AND opr AND opr,X AND opr,X AND ,X AND opr,SP AND opr,SP	Logical AND	$A \leftarrow (A) \& (M)$	0	–	–	↕	↕	–	IMM DIR EXT IX2 IX1 IX SP1 SP2	A4 B4 C4 D4 E4 F4 9EE4 9ED4	ii dd hh ll ee ff ff ff ff ee ff	2 3 4 4 3 2 4 5
ASL opr ASLA ASLX ASL opr,X ASL ,X ASL opr,SP	Arithmetic Shift Left (Same as LSL)		↕	–	–	↕	↕	↕	DIR INH INH IX1 IX SP1	38 48 58 68 78 9E68	dd 1 1 ff 3 ff	4 1 1 4 3 5
ASR opr ASRA ASRX ASR opr,X ASR opr,X ASR opr,SP	Arithmetic Shift Right		↕	–	–	↕	↕	↕	DIR INH INH IX1 IX SP1	37 47 57 67 77 9E67	dd 1 1 ff 3 ff	4 1 1 4 3 5
BCC rel	Branch if Carry Bit Clear	$PC \leftarrow (PC) + 2 + rel \text{ ? } (C) = 0$	–	–	–	–	–	–	REL	24	rr	3
BCLR n, opr	Clear Bit n in M	$M_n \leftarrow 0$	–	–	–	–	–	–	DIR (b0) DIR (b1) DIR (b2) DIR (b3) DIR (b4) DIR (b5) DIR (b6) DIR (b7)	11 13 15 17 19 1B 1D 1F	dd dd dd dd dd dd dd dd	4 4 4 4 4 4 4 4

**Table 6-1. Instruction Set Summary (Sheet 2 of 8)**

Source Form	Operation	Description	Effect on CCR						Address Mode	Opcode	Operand	Cycles
			V	H	I	N	Z	C				
BCS <i>rel</i>	Branch if Carry Bit Set (Same as BLO)	$PC \leftarrow (PC) + 2 + rel ? (C) = 1$	-	-	-	-	-	-	REL	25	rr	3
BEQ <i>rel</i>	Branch if Equal	$PC \leftarrow (PC) + 2 + rel ? (Z) = 1$	-	-	-	-	-	-	REL	27	rr	3
BGE <i>opr</i>	Branch if Greater Than or Equal To (Signed Operands)	$PC \leftarrow (PC) + 2 + rel ? (N \oplus V) = 0$	-	-	-	-	-	-	REL	90	rr	3
BGT <i>opr</i>	Branch if Greater Than (Signed Operands)	$PC \leftarrow (PC) + 2 + rel ? (Z) \mid (N \oplus V) = 0$	-	-	-	-	-	-	REL	92	rr	3
BHCC <i>rel</i>	Branch if Half Carry Bit Clear	$PC \leftarrow (PC) + 2 + rel ? (H) = 0$	-	-	-	-	-	-	REL	28	rr	3
BHCS <i>rel</i>	Branch if Half Carry Bit Set	$PC \leftarrow (PC) + 2 + rel ? (H) = 1$	-	-	-	-	-	-	REL	29	rr	3
BHI <i>rel</i>	Branch if Higher	$PC \leftarrow (PC) + 2 + rel ? (C) \mid (Z) = 0$	-	-	-	-	-	-	REL	22	rr	3
BHS <i>rel</i>	Branch if Higher or Same (Same as BCC)	$PC \leftarrow (PC) + 2 + rel ? (C) = 0$	-	-	-	-	-	-	REL	24	rr	3
BIH <i>rel</i>	Branch if $\overline{IRQ}$ Pin High	$PC \leftarrow (PC) + 2 + rel ? \overline{IRQ} = 1$	-	-	-	-	-	-	REL	2F	rr	3
BIL <i>rel</i>	Branch if $\overline{IRQ}$ Pin Low	$PC \leftarrow (PC) + 2 + rel ? \overline{IRQ} = 0$	-	-	-	-	-	-	REL	2E	rr	3
BIT # <i>opr</i> BIT <i>opr</i> BIT <i>opr</i> ,X BIT <i>opr</i> ,X BIT ,X BIT <i>opr</i> ,SP BIT <i>opr</i> ,SP	Bit Test	(A) & (M)	0	-	-	↕	↕	-	IMM DIR EXT IX2 IX1 IX SP1 SP2	A5 B5 C5 D5 E5 F5 9EE5 9ED5	ii dd hh ll ee ff ff ff ff ee ff	2 3 4 4 3 2 4 5
BLE <i>opr</i>	Branch if Less Than or Equal To (Signed Operands)	$PC \leftarrow (PC) + 2 + rel ? (Z) \mid (N \oplus V) = 1$	-	-	-	-	-	-	REL	93	rr	3
BLO <i>rel</i>	Branch if Lower (Same as BCS)	$PC \leftarrow (PC) + 2 + rel ? (C) = 1$	-	-	-	-	-	-	REL	25	rr	3
BLS <i>rel</i>	Branch if Lower or Same	$PC \leftarrow (PC) + 2 + rel ? (C) \mid (Z) = 1$	-	-	-	-	-	-	REL	23	rr	3
BLT <i>opr</i>	Branch if Less Than (Signed Operands)	$PC \leftarrow (PC) + 2 + rel ? (N \oplus V) = 1$	-	-	-	-	-	-	REL	91	rr	3
BMC <i>rel</i>	Branch if Interrupt Mask Clear	$PC \leftarrow (PC) + 2 + rel ? (I) = 0$	-	-	-	-	-	-	REL	2C	rr	3
BMI <i>rel</i>	Branch if Minus	$PC \leftarrow (PC) + 2 + rel ? (N) = 1$	-	-	-	-	-	-	REL	2B	rr	3
BMS <i>rel</i>	Branch if Interrupt Mask Set	$PC \leftarrow (PC) + 2 + rel ? (I) = 1$	-	-	-	-	-	-	REL	2D	rr	3
BNE <i>rel</i>	Branch if Not Equal	$PC \leftarrow (PC) + 2 + rel ? (Z) = 0$	-	-	-	-	-	-	REL	26	rr	3
BPL <i>rel</i>	Branch if Plus	$PC \leftarrow (PC) + 2 + rel ? (N) = 0$	-	-	-	-	-	-	REL	2A	rr	3
BRA <i>rel</i>	Branch Always	$PC \leftarrow (PC) + 2 + rel$	-	-	-	-	-	-	REL	20	rr	3

**Table 6-1. Instruction Set Summary (Sheet 3 of 8)**

Source Form	Operation	Description	Effect on CCR						Address Mode	Opcode	Operand	Cycles		
			V	H	I	N	Z	C						
BRCLR <i>n,opr,rel</i>	Branch if Bit <i>n</i> in M Clear	$PC \leftarrow (PC) + 3 + rel ? (Mn) = 0$						↓	DIR (b0)	01	dd rr	5		
										DIR (b1)	03	dd rr	5	
										DIR (b2)	05	dd rr	5	
										DIR (b3)	07	dd rr	5	
										DIR (b4)	09	dd rr	5	
										DIR (b5)	0B	dd rr	5	
										DIR (b6)	0D	dd rr	5	
										DIR (b7)	0F	dd rr	5	
BRN <i>rel</i>	Branch Never	$PC \leftarrow (PC) + 2$	-	-	-	-	-	-	REL	21	rr	3		
BRSET <i>n,opr,rel</i>	Branch if Bit <i>n</i> in M Set	$PC \leftarrow (PC) + 3 + rel ? (Mn) = 1$						↓	DIR (b0)	00	dd rr	5		
										DIR (b1)	02	dd rr	5	
										DIR (b2)	04	dd rr	5	
										DIR (b3)	06	dd rr	5	
										DIR (b4)	08	dd rr	5	
										DIR (b5)	0A	dd rr	5	
										DIR (b6)	0C	dd rr	5	
										DIR (b7)	0E	dd rr	5	
BSET <i>n,opr</i>	Set Bit <i>n</i> in M	$Mn \leftarrow 1$							DIR (b0)	10	dd	4		
										DIR (b1)	12	dd	4	
										DIR (b2)	14	dd	4	
										DIR (b3)	16	dd	4	
										DIR (b4)	18	dd	4	
										DIR (b5)	1A	dd	4	
										DIR (b6)	1C	dd	4	
										DIR (b7)	1E	dd	4	
BSR <i>rel</i>	Branch to Subroutine	$PC \leftarrow (PC) + 2$ ; push (PCL) $SP \leftarrow (SP) - 1$ ; push (PCH) $SP \leftarrow (SP) - 1$ $PC \leftarrow (PC) + rel$	-	-	-	-	-	-	REL	AD	rr	4		
CBEQ <i>opr,rel</i> CBEQA # <i>opr,rel</i> CBEQX # <i>opr,rel</i> CBEQ <i>opr,X+,rel</i> CBEQ <i>X+,rel</i> CBEQ <i>opr,SP,rel</i>	Compare and Branch if Equal	$PC \leftarrow (PC) + 3 + rel ? (A) - (M) = \$00$ $PC \leftarrow (PC) + 3 + rel ? (A) - (M) = \$00$ $PC \leftarrow (PC) + 3 + rel ? (X) - (M) = \$00$ $PC \leftarrow (PC) + 3 + rel ? (A) - (M) = \$00$ $PC \leftarrow (PC) + 2 + rel ? (A) - (M) = \$00$ $PC \leftarrow (PC) + 4 + rel ? (A) - (M) = \$00$							DIR	31	dd rr	5		
										IMM	41	ii rr	4	
										IMM	51	ii rr	4	
										IX1+	61	ff rr	5	
										IX+	71	rr	4	
										SP1	9E61	ff rr	6	
CLC	Clear Carry Bit	$C \leftarrow 0$	-	-	-	-	0	INH	98		1			
CLI	Clear Interrupt Mask	$I \leftarrow 0$	-	-	0	-	-	INH	9A		2			
CLR <i>opr</i> CLRA CLR X CLR H CLR <i>opr,X</i> CLR ,X CLR <i>opr,SP</i>	Clear	$M \leftarrow \$00$ $A \leftarrow \$00$ $X \leftarrow \$00$ $H \leftarrow \$00$ $M \leftarrow \$00$ $M \leftarrow \$00$ $M \leftarrow \$00$							DIR	3F	dd	3		
										INH	4F		1	
										INH	5F		1	
										INH	8C		1	
						0	-	-	0	1	INH	6F	ff	3
											IX	7F		2
											SP1	9E6F	ff	4

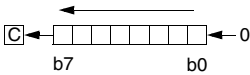
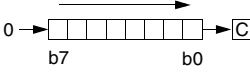

**Table 6-1. Instruction Set Summary (Sheet 4 of 8)**

Source Form	Operation	Description	Effect on CCR						Address Mode	Opcode	Operand	Cycles
			V	H	I	N	Z	C				
CMP #opr CMP opr CMP opr CMP opr,X CMP opr,X CMP ,X CMP opr,SP CMP opr,SP	Compare A with M	(A) – (M)	↓	–	–	↓	↓	↓	IMM DIR EXT IX2 IX1 IX SP1 SP2	A1 B1 C1 D1 E1 F1 9EE1 9ED1	ii dd hh ll ee ff ff ff ff ff ee ff	2 3 4 4 3 2 4 5
COM opr COMA COMX COM opr,X COM ,X COM opr,SP	Complement (One's Complement)	$M \leftarrow (\overline{M}) = \$FF - (M)$ $A \leftarrow (\overline{A}) = \$FF - (M)$ $X \leftarrow (\overline{X}) = \$FF - (M)$ $M \leftarrow (\overline{M}) = \$FF - (M)$ $M \leftarrow (\overline{M}) = \$FF - (M)$ $M \leftarrow (\overline{M}) = \$FF - (M)$	0	–	–	↓	↓	1	DIR INH INH IX1 IX SP1	33 43 53 63 73 9E63	dd ff ff ff	4 1 1 4 3 5
CPHX #opr CPHX opr	Compare H:X with M	(H:X) – (M:M + 1)	↓	–	–	↓	↓	↓	IMM DIR	65 75	ii ii+1 dd	3 4
CPX #opr CPX opr CPX opr CPX ,X CPX opr,X CPX opr,X CPX opr,SP CPX opr,SP	Compare X with M	(X) – (M)	↓	–	–	↓	↓	↓	IMM DIR EXT IX2 IX1 IX SP1 SP2	A3 B3 C3 D3 E3 F3 9EE3 9ED3	ii dd hh ll ee ff ff ff ff ee ff	2 3 4 4 3 2 4 5
DAA	Decimal Adjust A	(A) <sub>10</sub>	U	–	–	↓	↓	↓	INH	72		2
DBNZ opr,rel DBNZA rel DBNZX rel DBNZ opr,X,rel DBNZ X,rel DBNZ opr,SP,rel	Decrement and Branch if Not Zero	$A \leftarrow (A) - 1$ or $M \leftarrow (M) - 1$ or $X \leftarrow (X) - 1$ $PC \leftarrow (PC) + 3 + rel ? (result) \neq 0$ $PC \leftarrow (PC) + 2 + rel ? (result) \neq 0$ $PC \leftarrow (PC) + 2 + rel ? (result) \neq 0$ $PC \leftarrow (PC) + 3 + rel ? (result) \neq 0$ $PC \leftarrow (PC) + 2 + rel ? (result) \neq 0$ $PC \leftarrow (PC) + 4 + rel ? (result) \neq 0$	–	–	–	–	–	–	DIR INH INH IX1 IX SP1	3B 4B 5B 6B 7B 9E6B	dd rr rr rr ff rr rr ff rr	5 3 3 5 4 6
DEC opr DECA DECX DEC opr,X DEC ,X DEC opr,SP	Decrement	$M \leftarrow (M) - 1$ $A \leftarrow (A) - 1$ $X \leftarrow (X) - 1$ $M \leftarrow (M) - 1$ $M \leftarrow (M) - 1$ $M \leftarrow (M) - 1$	↓	–	–	↓	↓	–	DIR INH INH IX1 IX SP1	3A 4A 5A 6A 7A 9E6A	dd ff ff ff	4 1 1 4 3 5
DIV	Divide	$A \leftarrow (H:A)/(X)$ H ← Remainder	–	–	–	–	↓	↓	INH	52		7
EOR #opr EOR opr EOR opr EOR opr,X EOR opr,X EOR ,X EOR opr,SP EOR opr,SP	Exclusive OR M with A	$A \leftarrow (A \oplus M)$	0	–	–	↓	↓	–	IMM DIR EXT IX2 IX1 IX SP1 SP2	A8 B8 C8 D8 E8 F8 9EE8 9ED8	ii dd hh ll ee ff ff ff ff ee ff	2 3 4 4 3 2 4 5

# Central Processor Unit (CPU)

**Table 6-1. Instruction Set Summary (Sheet 5 of 8)**

Source Form	Operation	Description	Effect on CCR						Address Mode	Opcode	Operand	Cycles
			V	H	I	N	Z	C				
INC <i>opr</i> INCA INCX INC <i>opr</i> ,X INC ,X INC <i>opr</i> ,SP	Increment	M ← (M) + 1 A ← (A) + 1 X ← (X) + 1 M ← (M) + 1 M ← (M) + 1 M ← (M) + 1	↓	-	-	↓	↓	-	DIR INH INH IX1 IX SP1	3C 4C 5C 6C 7C 9E6C	dd  ff  ff	4 1 1 4 3 5
JMP <i>opr</i> JMP <i>opr</i> JMP <i>opr</i> ,X JMP <i>opr</i> ,X JMP ,X	Jump	PC ← Jump Address	-	-	-	-	-	-	DIR EXT IX2 IX1 IX	BC CC DC EC FC	dd hh ll ee ff ff	2 3 4 3 2
JSR <i>opr</i> JSR <i>opr</i> JSR <i>opr</i> ,X JSR <i>opr</i> ,X JSR ,X	Jump to Subroutine	PC ← (PC) + n (n = 1, 2, or 3) Push (PCL); SP ← (SP) - 1 Push (PCH); SP ← (SP) - 1 PC ← Unconditional Address	-	-	-	-	-	-	DIR EXT IX2 IX1 IX	BD CD DD ED FD	dd hh ll ee ff ff	4 5 6 5 4
LDA # <i>opr</i> LDA <i>opr</i> LDA <i>opr</i> LDA <i>opr</i> ,X LDA <i>opr</i> ,X LDA ,X LDA <i>opr</i> ,SP LDA <i>opr</i> ,SP	Load A from M	A ← (M)	0	-	-	↓	↓	-	IMM DIR EXT IX2 IX1 IX SP1 SP2	A6 B6 C6 D6 E6 F6 9EE6 9ED6	ii dd hh ll ee ff ff ff ff ee ff	2 3 4 4 3 2 4 5
LDHX # <i>opr</i> LDHX <i>opr</i>	Load H:X from M	H:X ← (M:M + 1)	0	-	-	↓	↓	-	IMM DIR	45 55	ii jj dd	3 4
LDX # <i>opr</i> LDX <i>opr</i> LDX <i>opr</i> LDX <i>opr</i> ,X LDX <i>opr</i> ,X LDX ,X LDX <i>opr</i> ,SP LDX <i>opr</i> ,SP	Load X from M	X ← (M)	0	-	-	↓	↓	-	IMM DIR EXT IX2 IX1 IX SP1 SP2	AE BE CE DE EE FE 9EEE 9EDE	ii dd hh ll ee ff ff ff ff ee ff	2 3 4 4 3 2 4 5
LSL <i>opr</i> LSLA LSLX LSL <i>opr</i> ,X LSL ,X LSL <i>opr</i> ,SP	Logical Shift Left (Same as ASL)		↓	-	-	↓	↓	↓	DIR INH INH IX1 IX SP1	38 48 58 68 78 9E68	dd  ff ff	4 1 1 4 3 5
LSR <i>opr</i> LSRA LSRX LSR <i>opr</i> ,X LSR ,X LSR <i>opr</i> ,SP	Logical Shift Right		↓	-	-	0	↓	↓	DIR INH INH IX1 IX SP1	34 44 54 64 74 9E64	dd  ff ff	4 1 1 4 3 5

**Table 6-1. Instruction Set Summary (Sheet 6 of 8)**

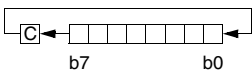
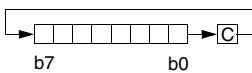
Source Form	Operation	Description	Effect on CCR						Address Mode	Opcode	Operand	Cycles
			V	H	I	N	Z	C				
MOV <i>opr,opr</i> MOV <i>opr,X+</i> MOV # <i>opr,opr</i> MOV <i>X+,opr</i>	Move	$(M)_{\text{Destination}} \leftarrow (M)_{\text{Source}}$ $H:X \leftarrow (H:X) + 1$ (IX+D, DIX+)	0	-	-	↕	↕	-	DD DIX+ IMD IX+D	4E 5E 6E 7E	dd dd dd ii dd dd	5 4 4 4
MUL	Unsigned multiply	$X:A \leftarrow (X) \times (A)$	-	0	-	-	-	0	INH	42		5
NEG <i>opr</i> NEGA NEGX NEG <i>opr,X</i> NEG ,X NEG <i>opr,SP</i>	Negate (Two's Complement)	$M \leftarrow -(M) = \$00 - (M)$ $A \leftarrow -(A) = \$00 - (A)$ $X \leftarrow -(X) = \$00 - (X)$ $M \leftarrow -(M) = \$00 - (M)$ $M \leftarrow -(M) = \$00 - (M)$	↕	-	-	↕	↕	↕	DIR INH INH IX1 IX SP1	30 40 50 60 70 9E60	dd  ff ff	4 1 1 4 3 5
NOP	No Operation	None	-	-	-	-	-	-	INH	9D		1
NSA	Nibble Swap A	$A \leftarrow (A[3:0]:A[7:4])$	-	-	-	-	-	-	INH	62		3
ORA # <i>opr</i> ORA <i>opr</i> ORA <i>opr</i> ORA <i>opr,X</i> ORA <i>opr,X</i> ORA ,X ORA <i>opr,SP</i> ORA <i>opr,SP</i>	Inclusive OR A and M	$A \leftarrow (A)   (M)$	0	-	-	↕	↕	-	IMM DIR EXT IX2 IX1 IX SP1 SP2	AA BA CA DA EA FA 9EEA 9EDA	ii dd hh ll ee ff ff  ff ee ff	2 3 4 4 3 2 4 5
PSHA	Push A onto Stack	Push (A); $SP \leftarrow (SP) - 1$	-	-	-	-	-	-	INH	87		2
PSHH	Push H onto Stack	Push (H); $SP \leftarrow (SP) - 1$	-	-	-	-	-	-	INH	8B		2
PSHX	Push X onto Stack	Push (X); $SP \leftarrow (SP) - 1$	-	-	-	-	-	-	INH	89		2
PULA	Pull A from Stack	$SP \leftarrow (SP + 1)$ ; Pull (A)	-	-	-	-	-	-	INH	86		2
PULH	Pull H from Stack	$SP \leftarrow (SP + 1)$ ; Pull (H)	-	-	-	-	-	-	INH	8A		2
PULX	Pull X from Stack	$SP \leftarrow (SP + 1)$ ; Pull (X)	-	-	-	-	-	-	INH	88		2
ROL <i>opr</i> ROLA ROLX ROL <i>opr,X</i> ROL ,X ROL <i>opr,SP</i>	Rotate Left through Carry		↕	-	-	↕	↕	↕	DIR INH INH IX1 IX SP1	39 49 59 69 79 9E69	dd  ff ff	4 1 1 4 3 5
ROR <i>opr</i> RORA RORX ROR <i>opr,X</i> ROR ,X ROR <i>opr,SP</i>	Rotate Right through Carry		↕	-	-	↕	↕	↕	DIR INH INH IX1 IX SP1	36 46 56 66 76 9E66	dd  ff ff	4 1 1 4 3 5
RSP	Reset Stack Pointer	$SP \leftarrow \$FF$	-	-	-	-	-	-	INH	9C		1

## Table 6-1. Instruction Set Summary (Sheet 7 of 8)

Source Form	Operation	Description	Effect on CCR						Address Mode	Opcode	Operand	Cycles
			V	H	I	N	Z	C				
RTI	Return from Interrupt	SP ← (SP) + 1; Pull (CCR) SP ← (SP) + 1; Pull (A) SP ← (SP) + 1; Pull (X) SP ← (SP) + 1; Pull (PCH) SP ← (SP) + 1; Pull (PCL)	↕	↕	↕	↕	↕	↕	INH	80		7
RTS	Return from Subroutine	SP ← SP + 1; Pull (PCH) SP ← SP + 1; Pull (PCL)	-	-	-	-	-	-	INH	81		4
SBC #opr SBC opr SBC opr SBC opr,X SBC opr,X SBC ,X SBC opr,SP SBC opr,SP	Subtract with Carry	$A \leftarrow (A) - (M) - (C)$	↕	-	-	↕	↕	↕	IMM DIR EXT IX2 IX1 IX SP1 SP2	A2 B2 C2 D2 E2 F2 9EE2 9ED2	ii dd hh ll ee ff ff ff ff ee ff	2 3 4 4 3 2 4 5
SEC	Set Carry Bit	$C \leftarrow 1$	-	-	-	-	-	1	INH	99		1
SEI	Set Interrupt Mask	$I \leftarrow 1$	-	-	1	-	-	-	INH	9B		2
STA opr STA opr STA opr,X STA opr,X STA ,X STA opr,SP STA opr,SP	Store A in M	$M \leftarrow (A)$	0	-	-	↕	↕	-	DIR EXT IX2 IX1 IX SP1 SP2	B7 C7 D7 E7 F7 9EE7 9ED7	dd hh ll ee ff ff ff ff ee ff	3 4 4 3 2 4 5
STHX opr	Store H:X in M	$(M:M + 1) \leftarrow (H:X)$	0	-	-	↕	↕	-	DIR	35	dd	4
STOP	Enable $\overline{IRQ}$ Pin; Stop Oscillator	$I \leftarrow 0$ ; Stop Oscillator	-	-	0	-	-	-	INH	8E		1
STX opr STX opr STX opr,X STX opr,X STX ,X STX opr,SP STX opr,SP	Store X in M	$M \leftarrow (X)$	0	-	-	↕	↕	-	DIR EXT IX2 IX1 IX SP1 SP2	BF CF DF EF FF 9EEF 9EDF	dd hh ll ee ff ff ff ff ee ff	3 4 4 3 2 4 5
SUB #opr SUB opr SUB opr SUB opr,X SUB opr,X SUB ,X SUB opr,SP SUB opr,SP	Subtract	$A \leftarrow (A) - (M)$	↕	-	-	↕	↕	↕	IMM DIR EXT IX2 IX1 IX SP1 SP2	A0 B0 C0 D0 E0 F0 9EE0 9ED0	ii dd hh ll ee ff ff ff ff ee ff	2 3 4 4 3 2 4 5

**Table 6-1. Instruction Set Summary (Sheet 8 of 8)**

Source Form	Operation	Description	Effect on CCR						Address Mode	Opcode	Operand	Cycles
			V	H	I	N	Z	C				
SWI	Software Interrupt	PC ← (PC) + 1; Push (PCL) SP ← (SP) – 1; Push (PCH) SP ← (SP) – 1; Push (X) SP ← (SP) – 1; Push (A) SP ← (SP) – 1; Push (CCR) SP ← (SP) – 1; I ← 1 PCH ← Interrupt Vector High Byte PCL ← Interrupt Vector Low Byte	–	–	1	–	–	–	INH	83		9
TAP	Transfer A to CCR	CCR ← (A)	↕	↕	↕	↕	↕	↕	INH	84		2
TAX	Transfer A to X	X ← (A)	–	–	–	–	–	–	INH	97		1
TPA	Transfer CCR to A	A ← (CCR)	–	–	–	–	–	–	INH	85		1
TST <i>opr</i> TSTA TSTX TST <i>opr</i> ,X TST ,X TST <i>opr</i> ,SP	Test for Negative or Zero	(A) – \$00 or (X) – \$00 or (M) – \$00	0	–	–	↕	↕	–	DIR INH INH IX1 IX SP1	3D 4D 5D 6D 7D 9E6D	dd  ff ff	3 1 1 3 2 4
TSX	Transfer SP to H:X	H:X ← (SP) + 1	–	–	–	–	–	–	INH	95		2
TXA	Transfer X to A	A ← (X)	–	–	–	–	–	–	INH	9F		1
TXS	Transfer H:X to SP	(SP) ← (H:X) – 1	–	–	–	–	–	–	INH	94		2

- |       |   |            |   |
|-------|---|------------|---|
| A     | Accumulator   | <i>n</i>   | Any bit                                     |
| C     | Carry/borrow bit  | <i>opr</i> | Operand (one or two bytes)                  |
| CCR   | Condition code register   | PC         | Program counter                             |
| dd    | Direct address of operand   | PCH        | Program counter high byte                   |
| dd rr | Direct address of operand and relative offset of branch instruction | PCL        | Program counter low byte                    |
| DD    | Direct to direct addressing mode                                    | REL        | Relative addressing mode                    |
| DIR   | Direct addressing mode  | <i>rel</i> | Relative program counter offset byte        |
| DIX+  | Direct to indexed with post increment addressing mode               | rr         | Relative program counter offset byte        |
| ee ff | High and low bytes of offset in indexed, 16-bit offset addressing   | SP1        | Stack pointer, 8-bit offset addressing mode |
| EXT   | Extended addressing mode  | SP2        | Stack pointer 16-bit offset addressing mode |
| ff    | Offset byte in indexed, 8-bit offset addressing                     | SP         | Stack pointer                               |
| H     | Half-carry bit  | U          | Undefined                                   |
| H     | Index register high byte  | V          | Overflow bit                                |
| hh ll | High and low bytes of operand address in extended addressing        | X          | Index register low byte                     |
| I     | Interrupt mask  | Z          | Zero bit                                    |
| ii    | Immediate operand byte  | &          | Logical AND                                 |
| IMD   | Immediate source to direct destination addressing mode              |            | Logical OR                                  |
| IMM   | Immediate addressing mode   | ⊕          | Logical EXCLUSIVE OR                        |
| INH   | Inherent addressing mode  | ()         | Contents of                                 |
| IX    | Indexed, no offset addressing mode                                  | –()        | Negation (two's complement)                 |
| IX+   | Indexed, no offset, post increment addressing mode                  | #          | Immediate value                             |
| IX+D  | Indexed with post increment to direct addressing mode               | «          | Sign extend                                 |
| IX1   | Indexed, 8-bit offset addressing mode                               | ←          | Loaded with                                 |
| IX1+  | Indexed, 8-bit offset, post increment addressing mode               | ?          | If  |
| IX2   | Indexed, 16-bit offset addressing mode                              | :          | Concatenated with                           |
| M     | Memory location   | ↕          | Set or cleared                              |
| N     | Negative bit  | –          | Not affected                                |

**Table 6-2. Opcode Map**

MSB LSB	Bit Manipulation		Branch		Read-Modify-Write				Control				Register/Memory							
	DIR	DIR	REL	DIR	INH	INH	IX1	SP1	IX	INH	INH	IMM	DIR	EXT	IX2	SP2	IX1	SP1	IX	
	0	1	2	3	4	5	6	9E6	7	8	9	A	B	C	D	9ED	E	9EE	F	
0	BRSET0 3 DIR	BSET0 2 DIR	BRA 2 REL	NEG 2 DIR	NEGA 1 INH	NEGX 1 INH	NEG 2 IX1	NEG 5 SP1	NEG 3 IX	RTI 1 INH	BGE 3 REL	SUB 2 IMM	SUB 3 DIR	SUB 3 EXT	SUB 3 IX2	SUB 5 SP2	SUB 3 IX1	SUB 4 SP1	SUB 2 IX	
1	BRCLR0 3 DIR	BCLR0 2 DIR	BRN 2 REL	CBEQ 3 DIR	CBEQA 3 IMM	CBEQX 3 IMM	CBEQ 3 IX1+	CBEQ 4 SP1	CBEQ 4 IX+	RTS 1 INH	BLT 2 REL	CMP 2 IMM	CMP 3 DIR	CMP 3 EXT	CMP 4 IX2	CMP 5 SP2	CMP 3 IX1	CMP 4 SP1	CMP 2 IX	
2	BRSET1 3 DIR	BSET1 2 DIR	BHI 2 REL	MUL 1 INH	DIV 1 INH	NSA 7 INH	NSA 3 INH	DAA 1 INH	DAA 1 INH	BGT 2 REL	SBC 2 IMM	SBC 3 DIR	SBC 3 EXT	SBC 4 IX2	SBC 5 SP2	SBC 3 IX1	SBC 4 SP1	SBC 1 IX	SBC 2 IX	
3	BRCLR1 3 DIR	BCLR1 2 DIR	BLS 2 REL	COM 2 DIR	COMA 1 INH	COMX 1 INH	COM 2 IX1	COM 5 SP1	COM 2 IX	SWI 9 INH	BLE 3 REL	CPX 2 IMM	CPX 2 DIR	CPX 3 EXT	CPX 4 IX2	CPX 5 SP2	CPX 3 IX1	CPX 4 SP1	CPX 1 IX	
4	BRSET2 3 DIR	BSET2 2 DIR	BCC 2 REL	LSR 2 DIR	LSRA 1 INH	LSRX 1 INH	LSR 2 IX1	LSR 3 SP1	LSR 1 IX	TAP 1 INH	TXS 2 INH	AND 2 IMM	AND 2 DIR	AND 3 EXT	AND 3 IX2	AND 4 SP2	AND 2 IX1	AND 3 SP1	AND 1 IX	
5	BRCLR2 3 DIR	BCLR2 2 DIR	BCS 2 REL	STHX 2 DIR	LDHX 3 IMM	LDHX 3 IMM	CPHX 3 IMM	CPHX 2 DIR	CPHX 2 DIR	TPA 1 INH	TSX 2 INH	BIT 2 IMM	BIT 2 DIR	BIT 3 EXT	BIT 3 IX2	BIT 4 SP2	BIT 2 IX1	BIT 3 SP1	BIT 1 IX	
6	BRSET3 3 DIR	BSET3 2 DIR	BNE 2 REL	ROR 2 DIR	RORA 1 INH	RORX 1 INH	ROR 2 IX1	ROR 5 SP1	ROR 3 IX	PULA 2 INH	LDA 2 IMM	LDA 2 DIR	LDA 3 EXT	LDA 3 IX2	LDA 4 SP2	LDA 2 IX1	LDA 3 SP1	LDA 1 IX	LDA 2 IX	
7	BRCLR3 3 DIR	BCLR3 2 DIR	BEQ 2 REL	ASR 2 DIR	ASRA 1 INH	ASRX 1 INH	ASR 2 IX1	ASR 5 SP1	ASR 3 IX	PSHA 1 INH	TAX 1 INH	AIS 2 IMM	STA 2 DIR	STA 3 EXT	STA 3 IX2	STA 4 SP2	STA 2 IX1	STA 3 SP1	STA 1 IX	
8	BRSET4 3 DIR	BSET4 2 DIR	BHCC 2 REL	LSL 2 DIR	LSLA 1 INH	LSLX 1 INH	LSL 2 IX1	LSL 3 SP1	LSL 1 IX	PULX 1 INH	CLC 2 IMM	EOR 2 IMM	EOR 2 DIR	EOR 3 EXT	EOR 3 IX2	EOR 4 SP2	EOR 2 IX1	EOR 3 SP1	EOR 1 IX	
9	BRCLR4 3 DIR	BCLR4 2 DIR	BHCS 2 REL	ROL 2 DIR	ROLA 1 INH	ROLX 1 INH	ROL 2 IX1	ROL 5 SP1	ROL 3 IX	PSHX 1 INH	SEC 1 INH	ADC 2 IMM	ADC 2 DIR	ADC 3 EXT	ADC 3 IX2	ADC 4 SP2	ADC 2 IX1	ADC 3 SP1	ADC 1 IX	
A	BRSET5 3 DIR	BSET5 2 DIR	BPL 2 REL	DEC 2 DIR	DECA 1 INH	DECX 1 INH	DEC 2 IX1	DEC 5 SP1	DEC 3 IX	PULH 1 INH	CLI 2 IMM	ORA 2 IMM	ORA 2 DIR	ORA 3 EXT	ORA 3 IX2	ORA 4 SP2	ORA 2 IX1	ORA 3 SP1	ORA 1 IX	
B	BRCLR5 3 DIR	BCLR5 2 DIR	BMI 2 REL	DBNZ 3 DIR	DBNZA 2 INH	DBNZX 2 INH	DBNZ 3 IX1	DBNZ 6 SP1	DBNZ 4 IX	PSHH 1 INH	SEI 1 INH	ADD 2 IMM	ADD 2 DIR	ADD 3 EXT	ADD 3 IX2	ADD 4 SP2	ADD 2 IX1	ADD 3 SP1	ADD 1 IX	
C	BRSET6 3 DIR	BSET6 2 DIR	BMC 2 REL	INC 2 DIR	INCA 1 INH	INCX 1 INH	INC 2 IX1	INC 5 SP1	INC 3 IX	CLRH 1 INH	RSP 1 INH	JMP 2 IMM	JMP 2 DIR	JMP 3 EXT	JMP 3 IX2	JMP 4 SP2	JMP 2 IX1	JMP 3 SP1	JMP 1 IX	
D	BRCLR6 3 DIR	BCLR6 2 DIR	BMS 2 REL	TST 2 DIR	TSTA 1 INH	TSTX 1 INH	TST 2 IX1	TST 3 SP1	TST 1 IX	NOP 1 INH	BSR 2 REL	JSR 2 DIR	JSR 3 EXT	JSR 3 IX2	JSR 4 SP2	JSR 2 IX1	JSR 3 SP1	JSR 1 IX	JSR 2 IX	
E	BRSET7 3 DIR	BSET7 2 DIR	BIL 2 REL	MOV 3 DD	MOV 3 DD	MOV 3 DD	MOV 3 DD	MOV 4 IX+D	MOV 2 IX+D	STOP 1 INH	* 1 INH	LDM 2 IMM	LDM 2 DIR	LDM 3 EXT	LDM 3 IX2	LDM 4 SP2	LDM 2 IX1	LDM 3 SP1	LDM 1 IX	
F	BRCLR7 3 DIR	BCLR7 2 DIR	BIH 2 REL	CLR 2 DIR	CLRA 1 INH	CLR 1 INH	CLR 2 IX1	CLR 4 SP1	CLR 2 IX	WAIT 1 INH	TXA 1 INH	AIX 2 IMM	STX 2 DIR	STX 3 EXT	STX 3 IX2	STX 4 SP2	STX 2 IX1	STX 3 SP1	STX 1 IX	

INH Inherent  
 IMM Immediate  
 DIR Direct  
 EXT Extended  
 DD Direct-Direct  
 IX+D Indexed-Direct  
 REL Relative  
 IX Indexed, No Offset  
 IX1 Indexed, 8-Bit Offset  
 IX2 Indexed, 16-Bit Offset  
 IMD Immediate-Direct  
 DIX+ Direct-Indexed  
 SP1 Stack Pointer, 8-Bit Offset  
 SP2 Stack Pointer, 16-Bit Offset  
 IX+ Indexed, No Offset with Post Increment  
 IX1+ Indexed, 1-Byte Offset with Post Increment

Low Byte of Opcode in Hexadecimal

MSB	0
LSB	5 BRSET0 3 DIR

High Byte of Opcode in Hexadecimal  
 Cycles  
 Opcode Mnemonic  
 Number of Bytes / Addressing Mode

## Section 7. Oscillator (OSC)

### 7.1 Contents

7.2	Introduction . . . . .	95
7.3	Oscillator External Connections . . . . .	96
7.4	I/O Signals . . . . .	97
7.4.1	Crystal Amplifier Input Pin (OSC1) . . . . .	97
7.4.2	Crystal Amplifier Output Pin (OSC2) . . . . .	97
7.4.3	Oscillator Enable Signal (SIMOSCEN) . . . . .	97
7.4.4	External Clock Source (OSCXCLK) . . . . .	97
7.4.5	Oscillator Out (OSCOUT) . . . . .	97
7.5	Low Power Modes . . . . .	98
7.5.1	Wait Mode . . . . .	98
7.5.2	Stop Mode . . . . .	98
7.6	Oscillator During Break Mode . . . . .	98

### 7.2 Introduction

The oscillator circuit is designed for use with crystals or ceramic resonators. The oscillator circuit generates the crystal clock signal, OSCXCLK, at the frequency of the crystal. This signal is divided by two before being passed on to the SIM for bus clock generation. **Figure 7-1** shows the structure of the oscillator. The oscillator requires various external components.

The MC68HC908LD64 operates from a nominal 24MHz crystal or external clock, providing an 8MHz internal bus clock. The 24MHz clock is required for various modules, such as the CGM and USB.

## 7.3 Oscillator External Connections

In its typical configuration, the oscillator requires five external components. The crystal oscillator is normally connected in a Pierce oscillator configuration, as shown in **Figure 7-1**. This figure shows only the logical representation of the internal components and may not represent actual circuitry. The oscillator configuration uses five components:

- Crystal,  $X_1$  (nominally 24MHz)
- Fixed capacitor,  $C_1$
- Tuning capacitor,  $C_2$  (can also be a fixed capacitor)
- Feedback resistor,  $R_B$
- Series resistor,  $R_S$  (not required for 24MHz crystal)

The series resistor ( $R_S$ ) is included in the diagram to follow strict Pierce oscillator guidelines and may not be required for all ranges of operation, especially with high frequency crystals. Refer to the crystal manufacturer's data for more information.

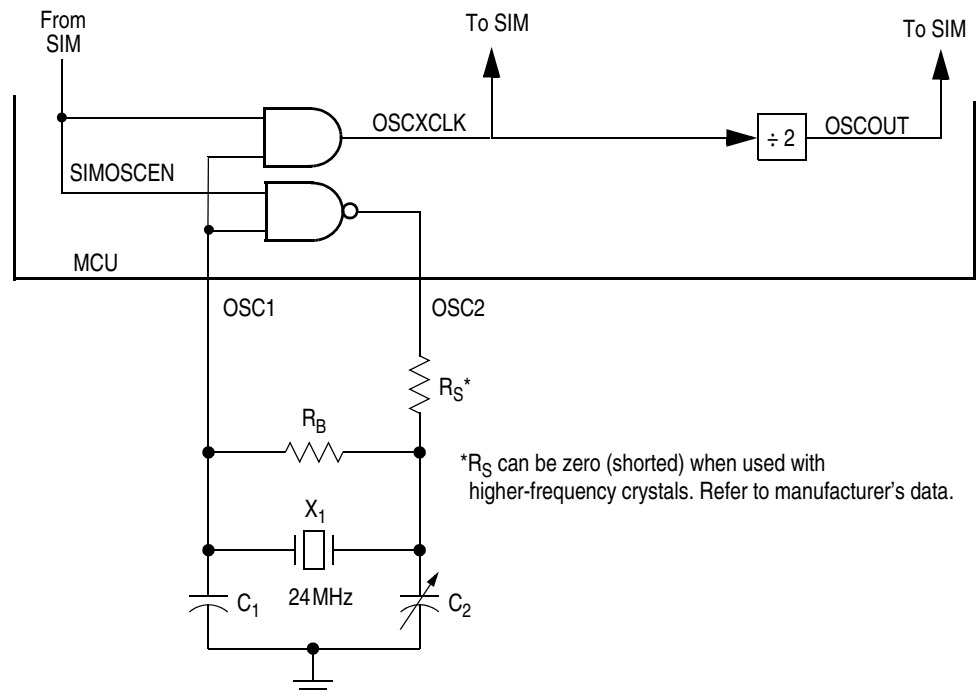

**Figure 7-1. Oscillator External Connections**



## 7.4 I/O Signals

The following paragraphs describe the oscillator I/O signals.

### 7.4.1 Crystal Amplifier Input Pin (OSC1)

The OSC1 pin is an input to the crystal oscillator amplifier.

An externally generated clock also can feed the OSC1 pin of the crystal oscillator circuit. Connect the external clock to the OSC1 pin and let the OSC2 pin float.

### 7.4.2 Crystal Amplifier Output Pin (OSC2)

The OSC2 pin is the output of the crystal oscillator inverting amplifier.

### 7.4.3 Oscillator Enable Signal (SIMOSCEN)

The SIMOSCEN signal comes from the SIM and enables the oscillator.

### 7.4.4 External Clock Source (OSCXCLK)

OSCXCLK is the crystal oscillator output signal. It runs at the full speed of the crystal ( $f_{XCLK}$ ) and comes directly from the crystal oscillator circuit. **Figure 7-1** shows only the logical relation of OSCXCLK to OSC1 and OSC2 and may not represent the actual circuitry. The duty cycle of OSCXCLK is unknown and may depend on the crystal and other external factors. Also, the frequency and amplitude of OSCXCLK can be unstable at start-up.

### 7.4.5 Oscillator Out (OSCOUT)

The clock driven to the SIM is the crystal frequency divided by two. This signal is driven to the SIM for generation of the bus clocks used by the CPU and other modules on the MCU. OSCOUT will be divided again in the SIM and results in the internal bus frequency being one fourth of the OSCXCLK frequency.

### 7.5 Low Power Modes

The WAIT and STOP instructions put the MCU in low-power-consumption standby modes.

#### 7.5.1 Wait Mode

The WAIT instruction has no effect on the oscillator logic. OSCXCLK continues to drive to the SIM module.

#### 7.5.2 Stop Mode

The STOP instruction disables the OSCXCLK output.

### 7.6 Oscillator During Break Mode

The oscillator continues drive OSCXCLK when the chip enters the break state.

## Section 8. Clock Generator Module (CGM)

### 8.1 Contents

8.2	Introduction . . . . .	100
8.3	Features . . . . .	100
8.4	Functional Description . . . . .	100
8.4.1	Crystal Oscillator Circuit . . . . .	103
8.5	CGM I/O Signals . . . . .	103
8.5.1	External Filter Capacitor Pin (CGMXFC) . . . . .	103
8.5.2	PLL Analog Power Pin (VDDA) . . . . .	103
8.5.3	PLL Analog Ground Pin (VSSA) . . . . .	103
8.5.4	Crystal Output Frequency Signal (OSCXCLK) . . . . .	104
8.5.5	Crystal Reference Frequency Signal (OSCRCLK) . . . . .	104
8.5.6	CGM Base Clock Output (DCLK1) . . . . .	104
8.5.7	CGM CPU Interrupt (CGMINT) . . . . .	104
8.6	CGM I/O Registers . . . . .	104
8.6.1	PLL Control Register (PCTL) . . . . .	105
8.6.2	PLL Bandwidth Control Register (PBWC) . . . . .	106
8.6.3	PLL Programming Register (PPG) . . . . .	108
8.6.4	H & V Sync Output Control Register (HVOCR) . . . . .	110
8.7	Interrupts . . . . .	111
8.8	Low-Power Modes . . . . .	111
8.8.1	Wait Mode . . . . .	111
8.8.2	Stop Mode . . . . .	112
8.9	CGM During Break Interrupts . . . . .	112

## 8.2 Introduction

This section describes the clock generator module (CGM). Using the crystal reference clock from the oscillator module, the CGM generates the display base clock, DCLK1, for the sync processor module. The CGM is able to generate a frequency up to 108MHz from a 24MHz reference clock.

## 8.3 Features

Features of the CGM include the following:

- Phase-locked loop with output frequency in integer multiples of the crystal reference
- Programmable hardware voltage-controlled oscillator (VCO) for low-jitter operation
- Automatic bandwidth control mode for low-jitter operation
- Automatic frequency lock detector
- CPU interrupt on entry or exit from locked condition

## 8.4 Functional Description

The CGM consists of three major sub-modules:

- Crystal oscillator circuit which generates the buffered constant crystal frequency clock, OSCRCLK. (See [Section 7. Oscillator \(OSC\)](#).)
- Phase-locked loop (PLL) which generates the programmable VCO frequency clock CGMVCLK.
- Base clock selector circuit; this software-controlled circuit selects either OSCXCLK divided by two or the VCO clock CGMVCLK divided by two, as the base clock DCLK1. The sync processor derives other display clocks from DCLK1.

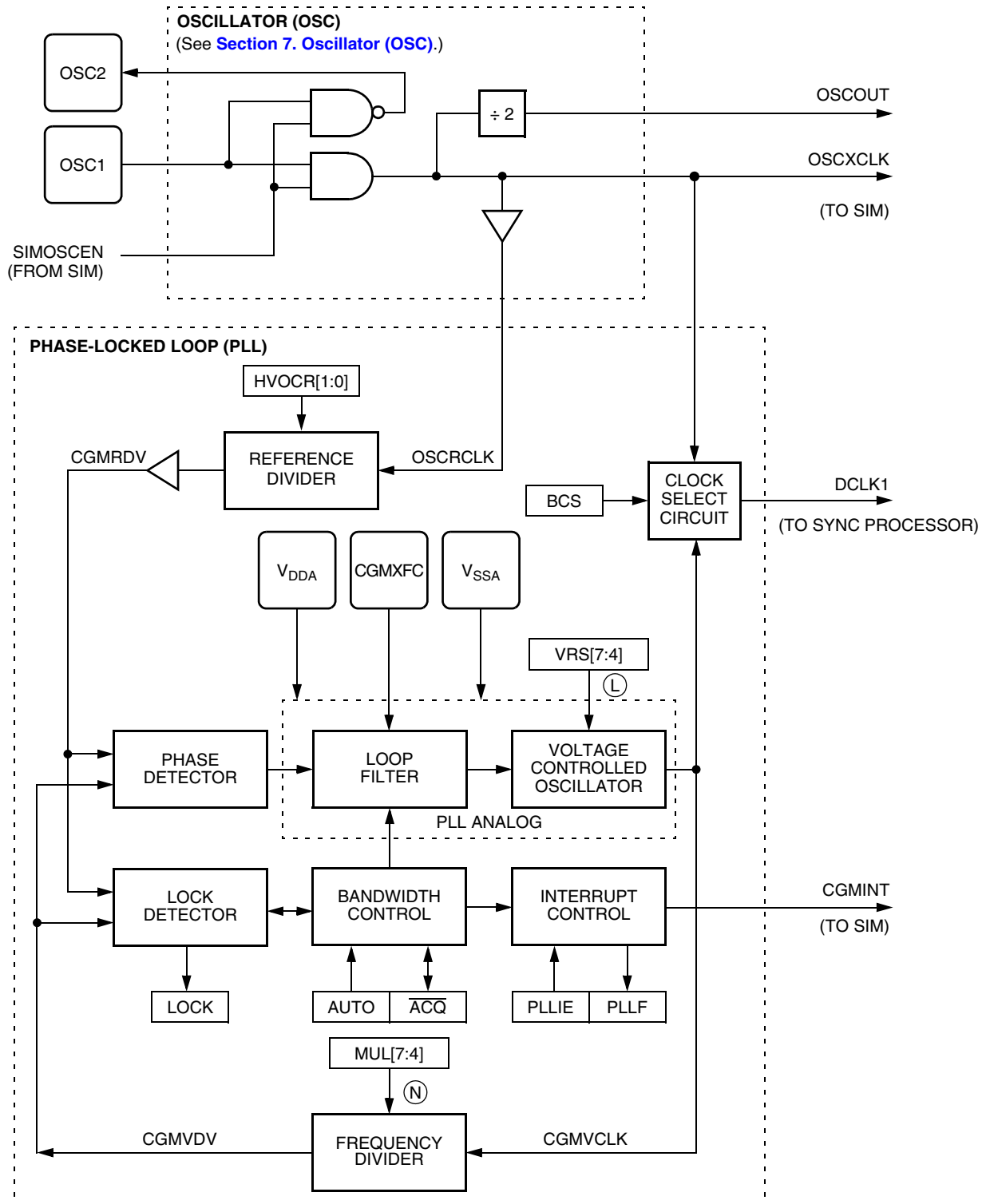

Figure 8-1. CGM Block Diagram

# Clock Generator Module (CGM)

Addr.	Register Name	Bit 7	6	5	4	3	2	1	Bit 0	
\$0038	PLL Control Register (PCTL)	Read:	PLLIE	PLLF	PLLON	BCS	1	1	1	1
		Write:								
		Reset:	0	0	1	0	1	1	1	1
\$0039	PLL Bandwidth Control Register (PBWC)	Read:	AUTO	LOCK	$\overline{ACQ}$	XLD	0	0	0	0
		Write:								
		Reset:	0	0	0	0	0	0	0	0
\$003A	PLL Programming Register (PPG)	Read:	MUL7	MUL6	MUL5	MUL4	VRS7	VRS6	VRS5	VRS4
		Write:								
		Reset:	0	1	1	0	0	1	1	0
\$003F	H&V Sync Output Control Register (HVOCR)	Read:				DCLKPH1	DCLKPH0	R	HVOCR1	HVOCR0
		Write:								
		Reset:				0	0		0	0

= Unimplemented     
 R = Reserved

**NOTES:**

1. When AUTO = 0, PLLIE is forced to logic zero and is read-only.
2. When AUTO = 0, PLLF and LOCK read as logic zero.
3. When AUTO = 1,  $\overline{ACQ}$  is read-only.
4. When PLLON = 0 or VRS[7:4] = \$0, BCS is forced to logic zero and is read-only.
5. When PLLON = 1, the PLL programming register is read-only.
6. When BCS = 1, PLLON is forced set and is read-only.

**Figure 8-2. CGM I/O Register Summary**

**Table 8-1. Free-Running HSOUT, VSOUT, DE, and DCLK Settings**

Register Settings			Output Pin			Video Modes
HVOCR[1:0]	MUL[7:4]	VRS[7:4]	HOUT Frequency	VOUT Frequency	DCLK Frequency	DE Video Mode
00	3	3	31.45kHz	59.91 Hz	24MHz	VGA 640 × 480
01	5	3	37.87kHz	60.31 Hz	40MHz	SVGA 800 × 600
10	8	6	48.37kHz	60.31 Hz	64MHz	XGA 1024 × 768
11	9	9	64.32kHz	60.00Hz	108MHz	SXGA 1280 × 1024

### 8.4.1 Crystal Oscillator Circuit

The crystal oscillator circuit consists of an inverting amplifier and an external crystal. The OSC1 pin is the input to the amplifier and the OSC2 pin is the output. The SIMOSCEN signal from the system integration module (SIM) enables the crystal oscillator circuit.

The OSCXCLK signal is the output of the crystal oscillator circuit and runs at a rate equal to the crystal frequency. OSCXCLK is then buffered to produce OSCRCLK, the PLL reference clock. (See [Section 7. Oscillator \(OSC\)](#).)

## 8.5 CGM I/O Signals

The following paragraphs describe the CGM I/O signals.

### 8.5.1 External Filter Capacitor Pin (CGMXFC)

The CGMXFC pin is required by the loop filter to filter out phase corrections. A small external capacitor ( $C_F$ ) is connected to this pin.

**NOTE:** *To prevent noise problems,  $C_F$  should be placed as close to the CGMXFC pin as possible, with minimum routing distances and no routing of other signals across the  $C_F$  connection.*

### 8.5.2 PLL Analog Power Pin (VDDA)

VDDA is the power pin used by the analog portions of the PLL. The pin should be connected to the same voltage potential as the VDD pin.

### 8.5.3 PLL Analog Ground Pin (VSSA)

VSSA is the ground pin used by the analog portions of the PLL. The pin should be connected to the same voltage potential as the VSS pin.

**NOTE:** *Route VDDA and VSSA carefully for maximum noise immunity and place bypass capacitors as close as possible to the package.*

### 8.5.4 Crystal Output Frequency Signal (OSCXCLK)

OSCXCLK is the crystal oscillator output signal. It runs at the full speed of the crystal ( $f_{XCLK}$ ) and is generated directly from the crystal oscillator circuit. The duty cycle of OSCXCLK is unknown and may depend on the crystal and other external factors. Also, the frequency and amplitude of OSCXCLK can be unstable at start-up.

### 8.5.5 Crystal Reference Frequency Signal (OSCRCLK)

OSCRCLK is the buffered version of OSCXCLK. It runs at the full speed of the crystal ( $f_{XCLK}$ ) and provides the reference for the PLL circuit.

### 8.5.6 CGM Base Clock Output (DCLK1)

DCLK1 is the clock output of the CGM. This signal goes to the sync processor, which generates the display clocks. DCLK1 is software programmable to be either the oscillator output (OSCXCLK) or the VCO clock (CGMVCLK).

### 8.5.7 CGM CPU Interrupt (CGMINT)

CGMINT is the interrupt signal generated by the PLL lock detector.

## 8.6 CGM I/O Registers

The following registers control and monitor operation of the CGM:

- PLL control register (PCTL)
- PLL bandwidth control register (PBWC)
- PLL programming register (PPG)
- H & V sync output control register (HVOCR)



### 8.6.1 PLL Control Register (PCTL)

The PLL control register contains the interrupt enable and flag bits, the on/off switch, and the base clock selector bit.

Address: \$0038

	Bit 7	6	5	4	3	2	1	Bit 0
Read:	PLLIE	PLLF	PLLON	BCS	1	1	1	1
Write:								
Reset:	0	0	1	0	1	1	1	1

 = Unimplemented

**Figure 8-3. PLL Control Register (PCTL)**

#### PLLIE — PLL Interrupt Enable Bit

This read/write bit enables the PLL to generate an interrupt request when the LOCK bit toggles, setting the PLL flag, PLLF. When the AUTO bit in the PLL bandwidth control register (PBWC) is clear, PLLIE cannot be written and reads as 0. Reset clears the PLLIE bit.

- 1 = PLL interrupts enabled
- 0 = PLL interrupts disabled

#### PLLF — PLL Interrupt Flag Bit

This read-only bit is set whenever the LOCK bit toggles. PLLF generates an interrupt request if the PLLIE bit is set also. PLLF always reads as 0 when the AUTO bit in the PLL bandwidth control register (PBWC) is clear. The PLLF bit should be cleared by reading the PLL control register. Reset clears the PLLF bit.

- 1 = Change in lock condition
- 0 = No change in lock condition

**NOTE:** *The PLLF bit should not be inadvertently cleared. Any read or read-modify-write operation on the PLL control register clears the PLLF bit.*

### PLLON — PLL On Bit

This read/write bit activates the PLL and enables the VCO clock, CGMVCLK. PLLON cannot be cleared if the VCO clock is driving the base clock, DCLK1 (BCS = 1). Reset sets this bit so that the loop can stabilize as the MCU is powering up.

- 1 = PLL on
- 0 = PLL off

### BCS — Base Clock Select Bit

This read/write bit selects either the crystal oscillator output, OSCXCLK, or the VCO clock, CGMVCLK, as the source of the CGM output, DCLK1. BCS cannot be set while the PLLON bit is clear. After toggling BCS, it may take up to three OSCXCLK and three CGMVCLK cycles to complete the transition from one source clock to the other. During the transition, DCLK1 is held in stasis. Reset and the STOP instruction clear the BCS bit.

- 1 = DCLK1 driven by CGMVCLK
- 0 = DCLK1 driven by OSCXCLK

**NOTE:** *PLLON and BCS have built-in protection that prevents the base clock selector circuit from selecting the VCO clock as the source of the base clock if the PLL is off. Therefore, PLLON cannot be cleared when BCS is set, and BCS cannot be set when PLLON is clear. If the PLL is off (PLLON = 0), selecting CGMVCLK requires two writes to the PLL control register.*

## 8.6.2 PLL Bandwidth Control Register (PBWC)

The PLL bandwidth control register does the following:

- Selects automatic or manual (software-controlled) bandwidth control mode
- Indicates when the PLL is locked
- In automatic bandwidth control mode, indicates when the PLL is in acquisition or tracking mode
- In manual operation, forces the PLL into acquisition or tracking mode

Address: \$0039

	Bit 7	6	5	4	3	2	1	Bit 0
Read:	AUTO	LOCK	$\overline{ACQ}$	XLD	0	0	0	0
Write:								
Reset:	0	0	0	0	0	0	0	0

 = Unimplemented

**Figure 8-4. PLL Bandwidth Control Register (PBWC)**

#### AUTO — Automatic Bandwidth Control Bit

This read/write bit selects automatic or manual bandwidth control. When initializing the PLL for manual operation (AUTO = 0), the  $\overline{ACQ}$  bit should be cleared before turning the PLL on. Reset clears the AUTO bit.

- 1 = Automatic bandwidth control
- 0 = Manual bandwidth control

#### LOCK — Lock Indicator Bit

When the AUTO bit is set, LOCK is a read-only bit that becomes set when the VCO clock CGMVCLK, is locked (running at the programmed frequency). When the AUTO bit is clear, LOCK reads as 0 and has no meaning. Reset clears the LOCK bit.

- 1 = VCO frequency correct or locked
- 0 = VCO frequency incorrect or unlocked

#### $\overline{ACQ}$ — Acquisition Mode Bit

When the AUTO bit is set,  $\overline{ACQ}$  is a read-only bit that indicates whether the PLL is in acquisition mode or tracking mode. When the AUTO bit is clear,  $\overline{ACQ}$  is a read/write bit that controls whether the PLL is in acquisition or tracking mode.

In automatic bandwidth control mode (AUTO = 1), the last-written value from manual operation is stored in a temporary location and is recovered when manual operation resumes. Reset clears this bit, enabling acquisition mode.

- 1 = Tracking mode
- 0 = Acquisition mode

## XLD — Crystal Loss Detect Bit

When the VCO output, CGMVCLK, is driving DCLK1, this read/write bit indicates whether the crystal reference frequency is active or not. To check the status of the crystal reference, the following procedure should be followed:

1. Write a 1 to XLD.
2. Wait  $4 \times N$  cycles. (N is the VCO frequency multiplier, MUL[7:4].)
3. Read XLD.
  - 1 = Crystal reference is not active
  - 0 = Crystal reference is active

The crystal loss detect function works only when the BCS bit is set, selecting CGMVCLK to drive DCLK1. When BCS is clear, XLD always reads as 0.

## Bits [3:0] — Reserved for test

These bits enable test functions not available in user mode. To ensure software portability from development systems to user applications, software should write zeros to Bits [3:0] whenever writing to PBWC.

### 8.6.3 PLL Programming Register (PPG)

The PLL programming register contains the programming information for the modulo feedback divider and the programming information for the hardware configuration of the VCO.

Address: \$003A

	Bit 7	6	5	4	3	2	1	Bit 0
Read:	MUL7	MUL6	MUL5	MUL4	VRS7	VRS6	VRS5	VRS4
Write:								
Reset:	0	1	1	0	0	1	1	0

**Figure 8-5. PLL Programming Register (PPG)**

### MUL[7:4] — Multiplier Select Bits

These read/write bits control the modulo feedback divider that selects the VCO frequency multiplier, N. A value of \$0 in the multiplier select bits configures the modulo feedback divider the same as a value of \$1. Reset initializes these bits to \$6 to give a default multiply value of 6.

**Table 8-2. VCO Frequency Multiplier (N) Selection**

MUL7:MUL6:MUL5:MUL4	VCO Frequency Multiplier (N)
0000	1
0001	1
0010	2
0011	3
↓	↓
1101	13
1110	14
1111	15

**NOTE:** *The multiplier select bits have built-in protection that prevents them from being written when the PLL is on (PLLON = 1).*

### VRS[7:4] — VCO Range Select Bits

These read/write bits control the hardware center-of-range linear multiplier L, which controls the hardware center-of-range frequency  $f_{VRS}$ . VRS[7:4] cannot be written when the PLLON bit in the PLL control register (PCTL) is set. A value of \$0 in the VCO range select bits disables the PLL and clears the BCS bit in the PCTL. Reset initializes the bits to \$6 to give a default range multiply value of 6.

**NOTE:** *The VCO range select bits have built-in protection that prevents them from being written when the PLL is on (PLLON = 1) and prevents selection of the VCO clock as the source of the base clock (BCS = 1) if the VCO range select bits are all clear.  
The VCO range select bits must be programmed correctly. Incorrect programming may result in failure of the PLL to achieve lock.*

## 8.6.4 H & V Sync Output Control Register (HVOCR)

The H&V sync output control register controls the PLL reference input prescaler and the final free-running waveforms for the sync processor output signals on HOUT, VOUT, DCLK, and DE pins.

(See [Section 17. Sync Processor.](#))

Address: \$003F

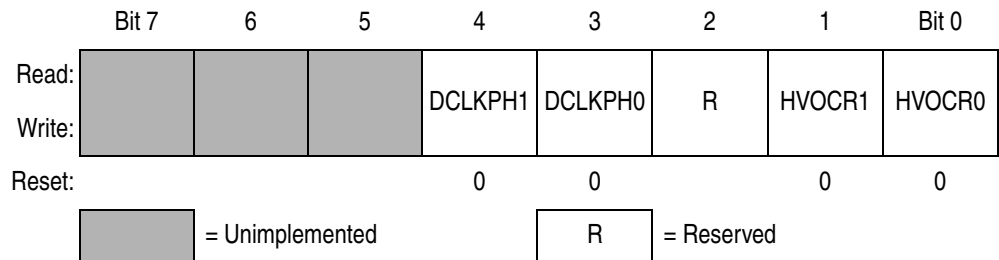

**Figure 8-6. H&V Sync Output Control Register (HVOCR)**

### DCLKPH[1:0] — DCLK Output Phase Adjustment

These two bits are programmed to adjust the DCLK output phase. Each increment adds approximately 2 to 3ns delay to the DCLK output.

### HVOCR[1:0] — Free Running Video Mode Select Bits

These two bits together with MUL[7:4] and VRS[7:4] in the PLL programming register determine the frequencies of the internal generated free-running signals for output to HOUT, VOUT, DE, and DCLK pins, when the SOUT bit is set in the sync processor I/O control register. These two bits determine the prescaler of PLL reference clock in the CGM module. When HVOCR[1:0]=11, the prescaler is 2; for other values, the prescaler is 3. Reset clears these bits, setting a default horizontal frequency of 31.25kHz and a vertical frequency of 60Hz, a video mode of 640×480.

Register Settings			Pin Outputs			Video Modes
HVOCR[1:0]	MUL[7:4]	VRS[7:4]	HOUT Frequency	VOUT Frequency	DCLK Frequency	DE Video Mode
00	3	3	31.45kHz	59.91 Hz	24MHz	VGA 640 × 480
01	5	3	37.87 kHz	60.31 Hz	40MHz	SVGA 800 × 600
10	8	6	48.37kHz	60.31 Hz	64MHz	XGA 1024 × 768
11	9	9	64.32kHz	60.00Hz	108MHz	SXGA 1280 × 1024

## 8.7 Interrupts

When the AUTO bit is set in the PLL bandwidth control register (PBWC), the PLL can generate a CPU interrupt request every time the LOCK bit changes state. The PLLIE bit in the PLL control register (PCTL) enables CPU interrupts from the PLL. PLLF, the interrupt flag in the PCTL, becomes set whether interrupts are enabled or not. When the AUTO bit is clear, CPU interrupts from the PLL are disabled and PLLF reads as 0.

Software should read the LOCK bit after a PLL interrupt request to see if the request was due to an entry into lock or an exit from lock. When the PLL enters lock, the VCO clock CGMVCLK, can be selected as the DCLK1 source by setting BCS in the PCTL. When the PLL exits lock, the VCO clock frequency is corrupt, and appropriate precautions should be taken. If the application is not frequency-sensitive, interrupts should be disabled to prevent PLL interrupt service routines from impeding software performance or from exceeding stack limitations.

*Software can select CGMVCLK as the DCLK1 source even if the PLL is not locked (LOCK = 0). Therefore, software should make sure the PLL is locked before setting the BCS bit.*

## 8.8 Low-Power Modes

The WAIT and STOP instructions put the MCU in low-power-consumption standby modes.

### 8.8.1 Wait Mode

The WAIT instruction does not affect the CGM. Before entering WAIT mode, software can disengage and turn off the PLL by clearing the BCS and PLLON bits in the PLL control register (PCTL). Less power-sensitive applications can disengage the PLL without turning it off. Applications that require the PLL to wake the MCU from WAIT mode also can deselect the PLL output without turning off the PLL.

### 8.8.2 Stop Mode

When the STOP instruction executes, the SIM drives the SIMOSCEN signal low, disabling the CGM and holding low all CGM outputs (OSCXCLK, DCLK1, and CGMINT).

If the STOP instruction is executed with the VCO clock, CGMVCLK, driving DCLK1, the PLL automatically clears the BCS bit in the PLL control register (PCTL), thereby selecting the crystal clock, OSCXCLK, as the source of DCLK1. When the MCU recovers from STOP, the crystal clock drives DCLK1 and BCS remains clear.

### 8.9 CGM During Break Interrupts

The system integration module (SIM) controls whether status bits in other modules can be cleared during the break state. The BCFE bit in the SIM break flag control register (SBFCR) enables software to clear status bits during the break state. See [Section 9. System Integration Module \(SIM\)](#).

To allow software to clear status bits during a break interrupt, a 1 should be written to the BCFE bit. If a status bit is cleared during the break state, it remains cleared when the MCU exits the break state.

To protect the PLLF bit during the break state, write a 0 to the BCFE bit. With BCFE at 0 (its default state), software can read and write the PLL control register during the break state without affecting the PLLF bit.



## Section 9. System Integration Module (SIM)

### 9.1 Contents

9.2	Introduction . . . . .	114
9.3	SIM Bus Clock Control and Generation . . . . .	117
9.3.1	Bus Timing . . . . .	117
9.3.2	Clock Start-Up from POR . . . . .	117
9.3.3	Clocks in Stop Mode and Wait Mode . . . . .	117
9.4	Reset and System Initialization . . . . .	118
9.4.1	External Pin Reset . . . . .	118
9.4.2	Active Resets from Internal Sources . . . . .	119
9.4.2.1	Power-On Reset . . . . .	120
9.4.2.2	Computer Operating Properly (COP) Reset . . . . .	121
9.4.2.3	Low-Voltage Inhibit Reset . . . . .	121
9.4.2.4	Illegal Opcode Reset . . . . .	121
9.4.2.5	Illegal Address Reset . . . . .	122
9.5	SIM Counter . . . . .	122
9.5.1	SIM Counter During Power-On Reset . . . . .	122
9.5.2	SIM Counter During Stop Mode Recovery . . . . .	122
9.5.3	SIM Counter and Reset States . . . . .	123
9.6	Exception Control . . . . .	123
9.6.1	Interrupts . . . . .	124
9.6.1.1	Hardware Interrupts . . . . .	126
9.6.1.2	SWI Instruction . . . . .	127
9.6.2	Interrupt Status Registers . . . . .	127
9.6.2.1	Interrupt Status Register 1 . . . . .	129
9.6.2.2	Interrupt Status Register 2 . . . . .	129
9.6.3	Reset . . . . .	130
9.6.4	Break Interrupts . . . . .	130
9.6.5	Status Flag Protection in Break Mode . . . . .	130

9.7	Low-Power Modes .....	131
9.7.1	Wait Mode .....	131
9.7.2	Stop Mode .....	132
9.8	SIM Registers .....	134
9.8.1	SIM Break Status Register (SBSR) .....	134
9.8.2	SIM Reset Status Register (SRSR) .....	135
9.8.3	SIM Break Flag Control Register (SBFCR) .....	136

## 9.2 Introduction

This section describes the system integration module, which supports up to 16 external and/or internal interrupts. Together with the CPU, the SIM controls all MCU activities. A block diagram of the SIM is shown in **Figure 9-1**. **Figure 9-2** shows a summary of the SIM I/O registers. The SIM is a system state controller that coordinates CPU and exception timing. The SIM is responsible for:

- Bus clock generation and control for CPU and peripherals:
  - Stop/wait/reset/break entry and recovery
  - Internal clock control
- Master reset control, including power-on reset (POR) and COP timeout
- Interrupt control:
  - Acknowledge timing
  - Arbitration control timing
  - Vector address generation
- CPU enable/disable timing
- Modular architecture expandable to 128 interrupt sources

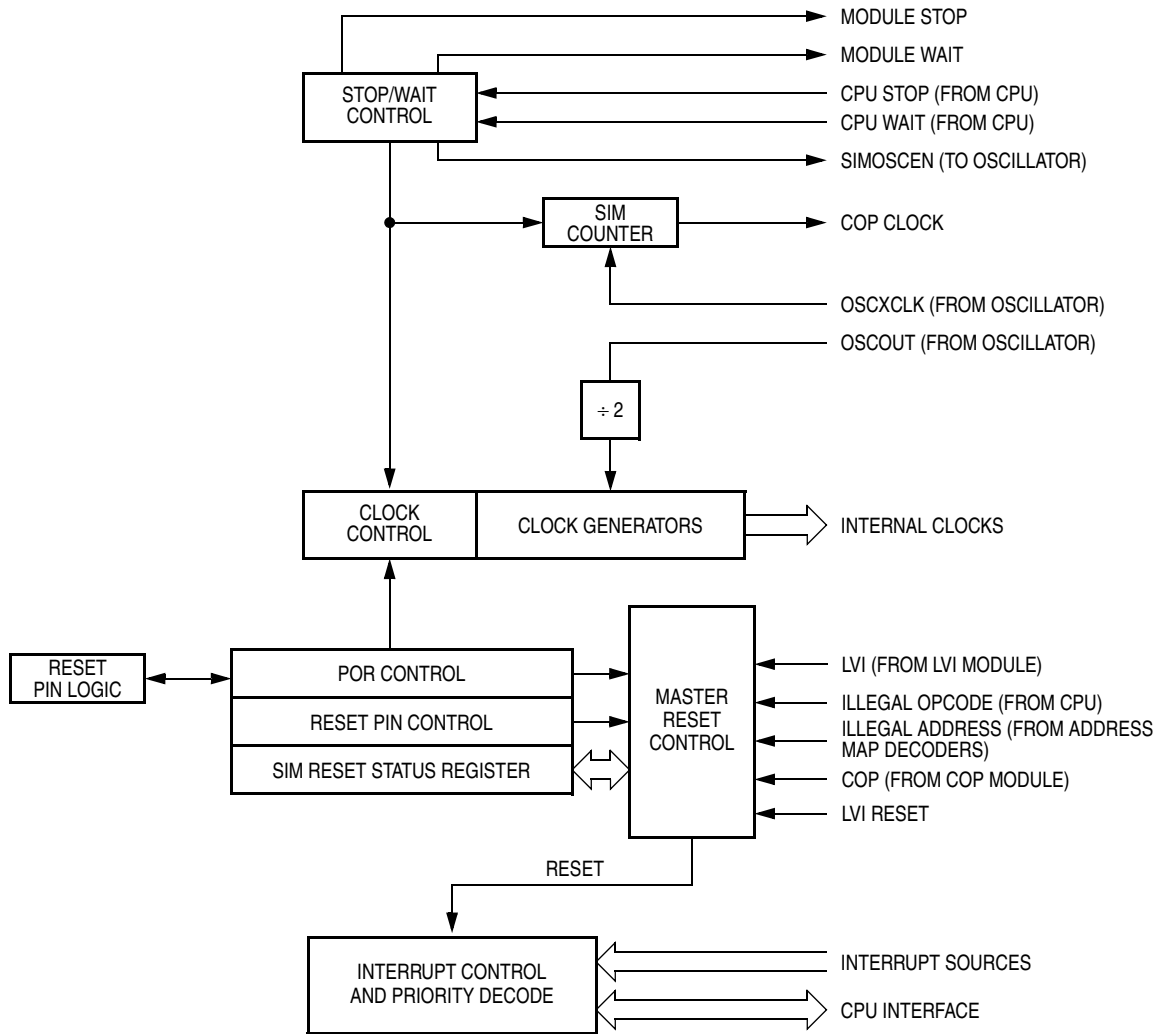

**Figure 9-1. SIM Block Diagram**

# System Integration Module (SIM)

Addr.	Register Name	Bit 7	6	5	4	3	2	1	Bit 0	
\$FE00	SIM Break Status Register (SBSR)	Read:	R	R	R	R	R	SBSW	R	
		Write:						Note		
		Reset:	0							
\$FE01	SIM Reset Status Register (SRSR)	Read:	POR	PIN	COP	ILOP	ILAD	USB	0	0
		Write:								
		POR:	1	0	0	0	0	0	0	0
\$FE03	SIM Break Flag Control Register (SBFCR)	Read:	BCFE	R	R	R	R	R	R	
		Write:								
		Reset:	0							
\$FE04	Interrupt Status Register 1 (INT1)	Read:	IF6	IF5	IF4	IF3	IF2	IF1	0	0
		Write:	R	R	R	R	R	R	R	R
		Reset:	0	0	0	0	0	0	0	0
\$FE05	Interrupt Status Register 2 (INT2)	Read:	IF14	IF13	IF12	IF11	IF10	IF9	IF8	IF7
		Write:	R	R	R	R	R	R	R	R
		Reset:	0	0	0	0	0	0	0	0

Note: Writing a logic 0 clears SBSW.  = Unimplemented R = Reserved

**Figure 9-2. SIM I/O Register Summary**

**Table 9-1** shows the internal signal names used in this section.

**Table 9-1. Signal Name Conventions**

Signal Name	Description
OSCXCLK	Buffered version of OSC1 from the oscillator
OSCOUT	The OSCXCLK frequency divided by two. This signal is again divided by two in the SIM to generate the internal bus clocks. (Bus clock = OSCXCLK divided by four)
IAB	Internal address bus
IDB	Internal data bus
PORRST	Signal from the power-on reset module to the SIM
IRST	Internal reset signal
R/ $\overline{W}$	Read/write signal

## 9.3 SIM Bus Clock Control and Generation

The bus clock generator provides system clock signals for the CPU and peripherals on the MCU. The system clocks are generated from an incoming clock, OSCOUT, as shown in [Figure 9-3](#).

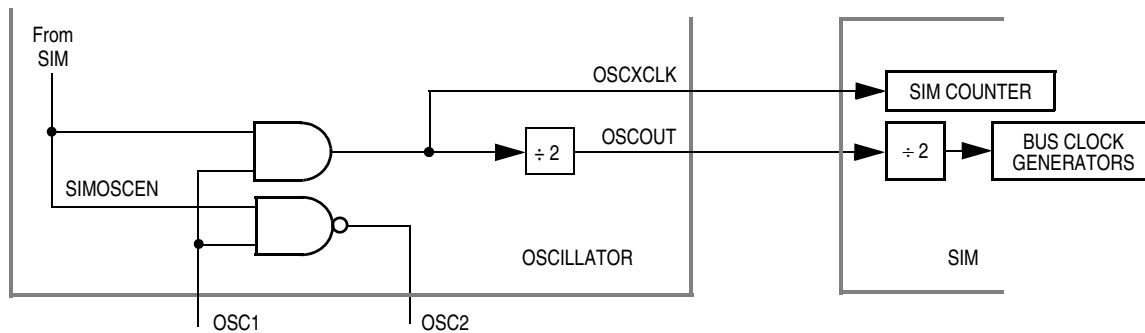

**Figure 9-3. OSC Clock Signals**

### 9.3.1 Bus Timing

In user mode, the internal bus frequency is the oscillator frequency (OSCXCLK) divided by four.

### 9.3.2 Clock Start-Up from POR

When the power-on reset module generates a reset, the clocks to the CPU and peripherals are inactive and held in an inactive phase until after the 4096 OSCXCLK cycle POR timeout has completed. The  $\overline{RST}$  is driven low by the SIM during this entire period. The IBUS clocks start upon completion of the timeout.

### 9.3.3 Clocks in Stop Mode and Wait Mode

Upon exit from stop mode (by an interrupt, break, or reset), the SIM allows OSCXCLK to clock the SIM counter. The CPU and peripheral clocks do not become active until after the stop delay timeout. This timeout is selectable as 4096 or 32 OSCXCLK cycles. (See [9.7.2 Stop Mode](#).)

In wait mode, the CPU clocks are inactive. The SIM also produces two sets of clocks for other modules. Refer to the wait mode subsection of each module to see if the module is active or inactive in wait mode. Some modules can be programmed to be active in wait mode.

## 9.4 Reset and System Initialization

The MCU has the following reset sources:

- Power-on reset module (POR)
- External reset pin ( $\overline{\text{RST}}$ )
- Computer operating properly module (COP)
- Low-voltage inhibit (LVI)
- Illegal opcode
- Illegal address

All of these resets produce the vector \$FFFE–\$FFFF (\$FEFE–\$FEFF in monitor mode) and assert the internal reset signal (IRST). IRST causes all registers to be returned to their default values and all modules to be returned to their reset states.

An internal reset clears the SIM counter (see [9.5 SIM Counter](#)), but an external reset does not. Each of the resets sets a corresponding bit in the SIM reset status register (SRSR) (see [9.8 SIM Registers](#)).

### 9.4.1 External Pin Reset

Pulling the asynchronous  $\overline{\text{RST}}$  pin low halts all processing. The PIN bit of the SIM reset status register (SRSR) is set as long as  $\overline{\text{RST}}$  is held low for a minimum of 67 OSCXCLK cycles, assuming that the POR was not the source of the reset (see [Table 9-2. PIN Bit Set Timing](#)). [Figure 9-4](#) shows the relative timing.

**Table 9-2. PIN Bit Set Timing**

Reset Type	Number of Cycles Required to Set PIN
POR	4163 (4096 + 64 + 3)
All others	67 (64 + 3)

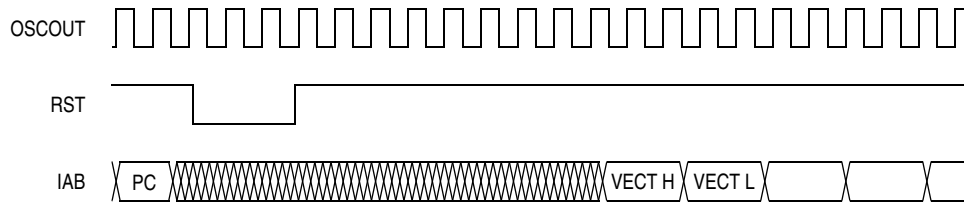

**Figure 9-4. External Reset Timing**

### 9.4.2 Active Resets from Internal Sources

SIM module in HC08 has the capability to drive the  $\overline{\text{RST}}$  pin low when internal reset events occur.

All internal reset sources actively pull the  $\overline{\text{RST}}$  pin low for 32 OSCXCLK cycles to allow resetting of external peripherals. The internal reset signal IRST continues to be asserted for an additional 32 cycles (see **Figure 9-5. Internal Reset Timing**). An internal reset can be caused by an illegal address, illegal opcode, COP timeout, or POR (see **Figure 9-6. Sources of Internal Reset**). Note that for POR resets, the SIM cycles through 4096 OSCXCLK cycles during which the SIM forces the  $\overline{\text{RST}}$  pin low. The internal reset signal then follows the sequence from the falling edge of  $\overline{\text{RST}}$  shown in **Figure 9-5**.

The COP reset is asynchronous to the bus clock.

The active reset feature allows the part to issue a reset to peripherals and other chips within a system built around the MCU.

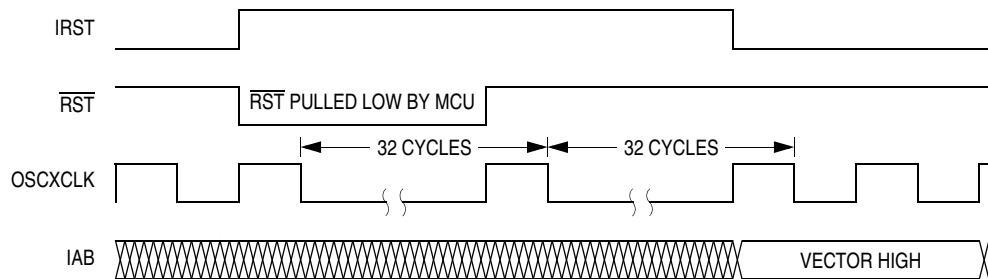

**Figure 9-5. Internal Reset Timing**

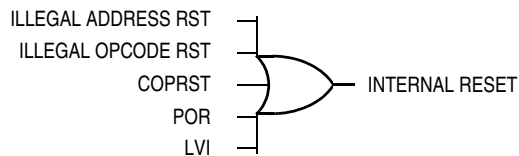

**Figure 9-6. Sources of Internal Reset**

## 9.4.2.1 Power-On Reset

When power is first applied to the MCU, the power-on reset module (POR) generates a pulse to indicate that power-on has occurred. The external reset pin ( $\overline{\text{RST}}$ ) is held low while the SIM counter counts out 4096 OSCXCLK cycles. Sixty-four OSCXCLK cycles later, the CPU and memories are released from reset to allow the reset vector sequence to occur.

At power-on, the following events occur:

- A POR pulse is generated.
- The internal reset signal is asserted.
- The SIM enables the oscillator to drive OSCXCLK.
- Internal clocks to the CPU and modules are held inactive for 4096 OSCXCLK cycles to allow stabilization of the oscillator.
- The  $\overline{\text{RST}}$  pin is driven low during the oscillator stabilization time.
- The POR bit of the SIM reset status register (SRSR) is set and all other bits in the register are cleared.

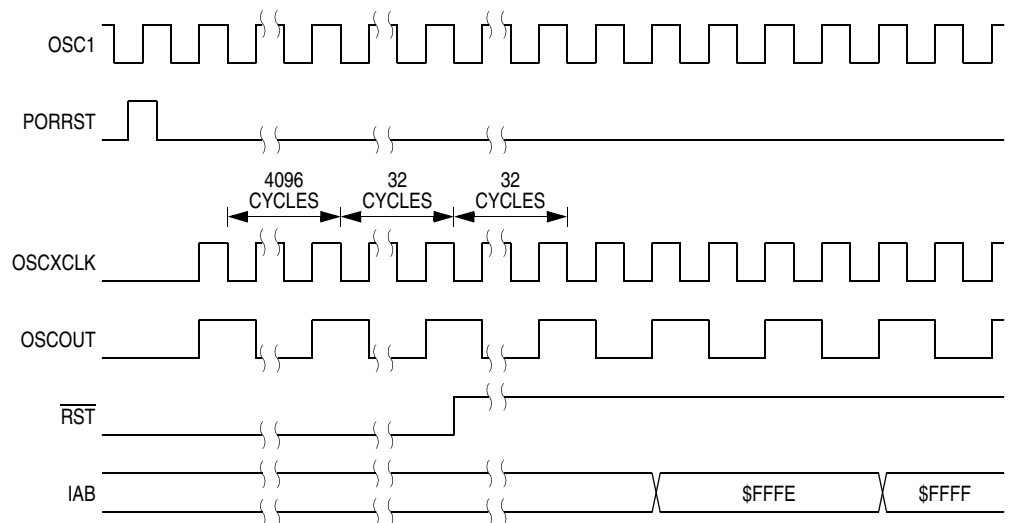

**Figure 9-7. POR Recovery**



#### 9.4.2.2 Computer Operating Properly (COP) Reset

An input to the SIM is reserved for the COP reset signal. The overflow of the COP counter causes an internal reset and sets the COP bit in the SIM reset status register (SRSR). The SIM actively pulls down the  $\overline{\text{RST}}$  pin for all internal reset sources.

To prevent a COP module timeout, write any value to location \$FFFF. Writing to location \$FFFF clears the COP counter and bits 12 through 5 of the SIM counter. The SIM counter output, which occurs at least every  $2^{12} - 2^4$  OSCXCLK cycles, drives the COP counter. The COP should be serviced as soon as possible out of reset to guarantee the maximum amount of time before the first timeout.

The COP module is disabled if the  $\overline{\text{RST}}$  pin or the  $\overline{\text{IRQ}}$  is held at  $V_{\text{TST}}$  while the MCU is in monitor mode. The COP module can be disabled only through combinational logic conditioned with the high voltage signal on the  $\overline{\text{RST}}$  pin or the  $\overline{\text{IRQ}}$  pin. This prevents the COP from becoming disabled as a result of external noise. During a break state,  $V_{\text{TST}}$  on the  $\overline{\text{RST}}$  pin disables the COP module.

#### 9.4.2.3 Low-Voltage Inhibit Reset

The low-voltage inhibit circuit performs an internal reset when the  $V_{\text{DD}}$  voltage falls to the LVI trip voltage  $V_{\text{TRIPF}}$ . The external reset pin ( $\overline{\text{RST}}$ ) is held low while the SIM counter counts out 4096 OSCXCLK cycles. Sixty-four OSCXCLK cycles later, the CPU and memories are released from reset to allow the reset vector sequence to occur.

#### 9.4.2.4 Illegal Opcode Reset

The SIM decodes signals from the CPU to detect illegal instructions. An illegal instruction sets the ILOP bit in the SIM reset status register (SRSR) and causes a reset.

If the stop enable bit, STOP, in the configure register (CONFIG) is logic zero, the SIM treats the STOP instruction as an illegal opcode and causes an illegal opcode reset. The SIM actively pulls down the  $\overline{\text{RST}}$  pin for all internal reset sources.

### 9.4.2.5 Illegal Address Reset

An opcode fetch from an unmapped address generates an illegal address reset. The SIM verifies that the CPU is fetching an opcode prior to asserting the ILAD bit in the SIM reset status register (SRSR) and resetting the MCU. A data fetch from an unmapped address does not generate a reset. The SIM actively pulls down the  $\overline{\text{RST}}$  pin for all internal reset sources.

## 9.5 SIM Counter

The SIM counter is used by the power-on reset module (POR) and in stop mode recovery to allow the oscillator time to stabilize before enabling the internal bus (IBUS) clocks. The SIM counter also serves as a prescaler for the computer operating properly module (COP). The SIM counter overflow supplies the clock for the COP module. The SIM counter is 12 bits long and is clocked by the falling edge of OSCXCLK.

### 9.5.1 SIM Counter During Power-On Reset

The power-on reset module (POR) detects power applied to the MCU. At power-on, the POR circuit asserts the signal PORRST. Once the SIM is initialized, it enables the oscillator to drive the bus clock state machine.

### 9.5.2 SIM Counter During Stop Mode Recovery

The SIM counter also is used for stop mode recovery. The STOP instruction clears the SIM counter. After an interrupt, break, or reset, the SIM senses the state of the short stop recovery bit, SSREC, in the configure register (CONFIG). If the SSREC bit is a logic one, then the stop recovery is reduced from the normal delay of 4096 OSCXCLK cycles down to 32 OSCXCLK cycles. This is ideal for applications using canned oscillators that do not require long start-up times from stop mode. External crystal applications should use the full stop recovery time, that is, with SSREC cleared.

### 9.5.3 SIM Counter and Reset States

External reset has no effect on the SIM counter (see [9.7.2 Stop Mode](#)). The SIM counter is free-running after all reset states (see [9.4.2 Active Resets from Internal Sources](#) for counter control and internal reset recovery sequences).

## 9.6 Exception Control

Normally, sequential program execution can be changed in three different ways:

- Interrupts
  - Maskable hardware CPU interrupts
  - Non-maskable software interrupt instruction (SWI)
- Reset
- Break interrupts

## 9.6.1 Interrupts

An interrupt temporarily changes the sequence of program execution to respond to a particular event. **Figure 9-10** flow charts the handling of system interrupts.

Interrupts are latched, and arbitration is performed in the SIM at the start of interrupt processing. The arbitration result is a constant that the CPU uses to determine which vector to fetch. Once an interrupt is latched by the SIM, no other interrupt can take precedence, regardless of priority, until the latched interrupt is serviced (or the I bit is cleared).

At the beginning of an interrupt, the CPU saves the CPU register contents on the stack and sets the interrupt mask (I bit) to prevent additional interrupts. At the end of an interrupt, the RTI instruction recovers the CPU register contents from the stack so that normal processing can resume. **Figure 9-8** shows interrupt entry timing. **Figure 9-9** shows interrupt recovery timing.

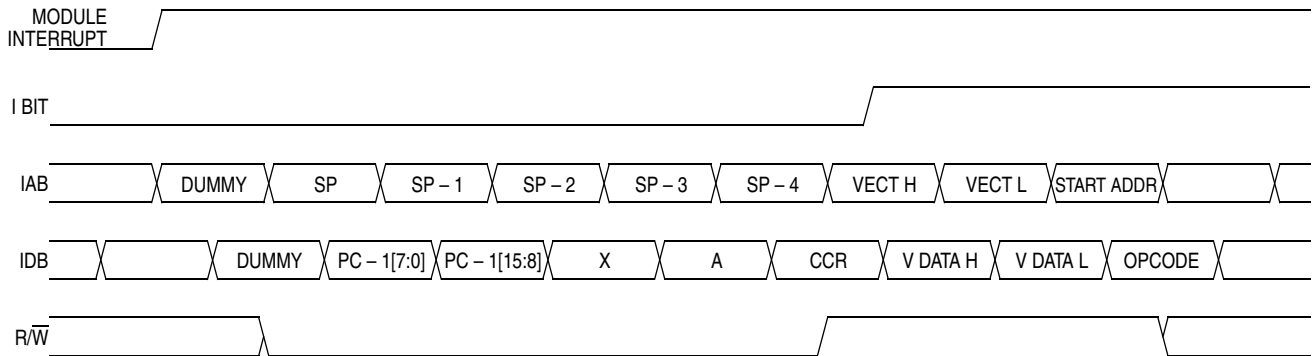

**Figure 9-8. Interrupt Entry**

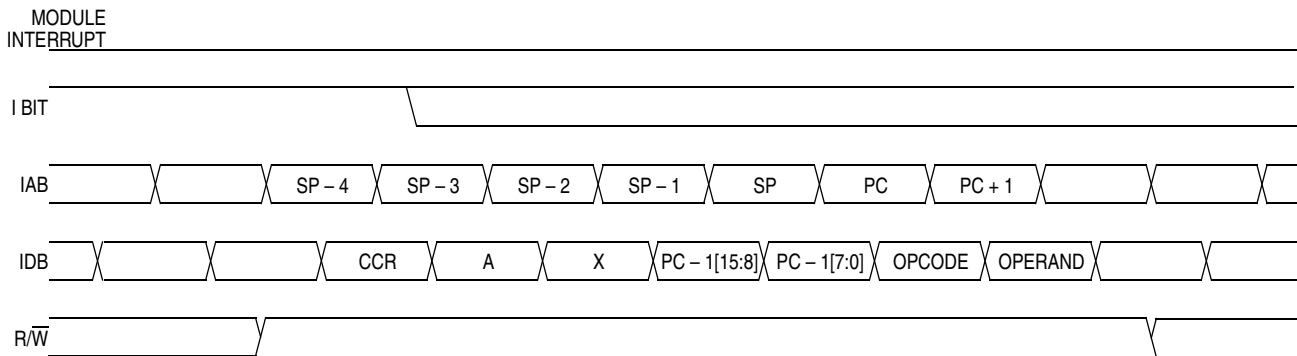

**Figure 9-9. Interrupt Recovery**

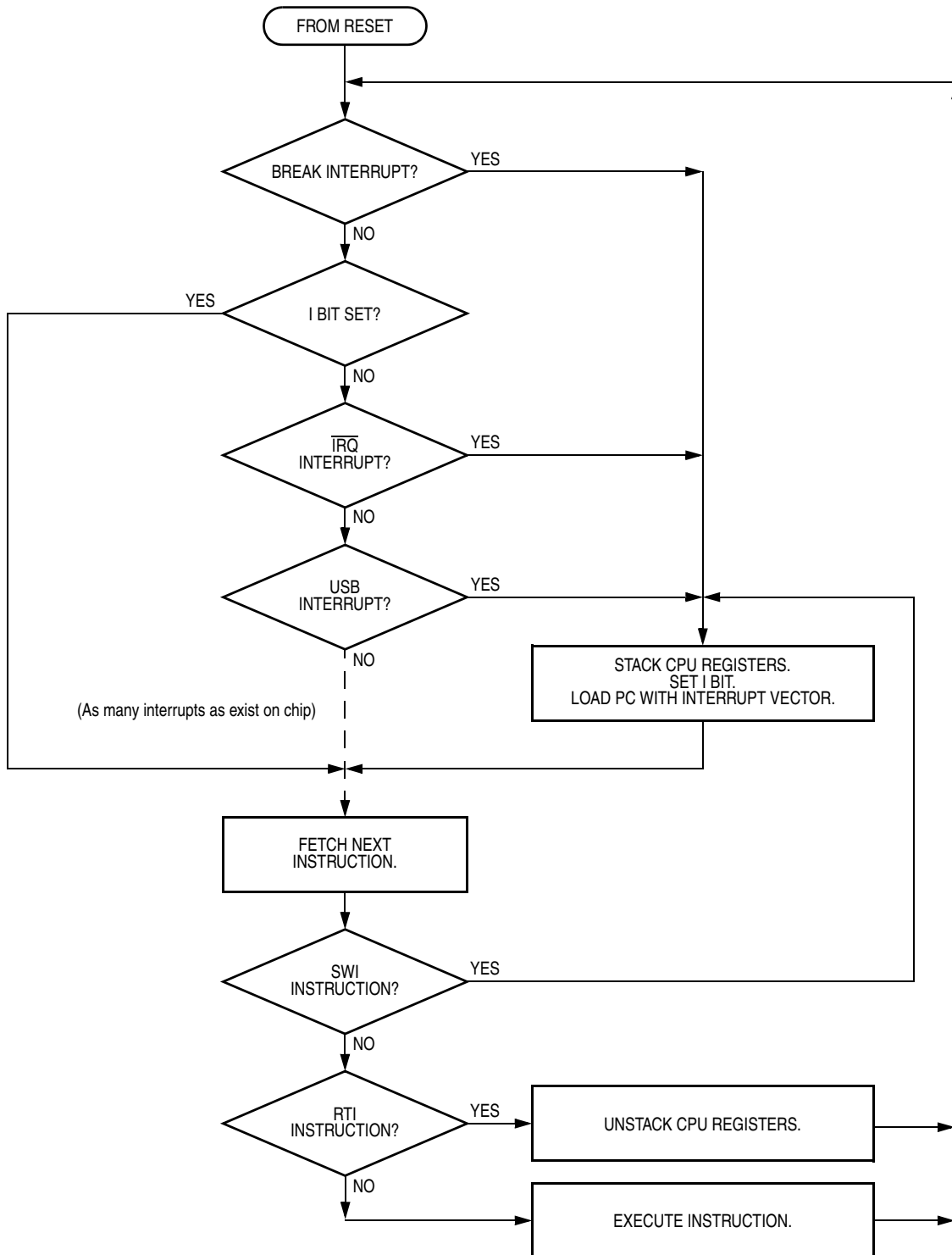

**Figure 9-10. Interrupt Processing**

Interrupts are latched, and arbitration is performed in the SIM at the start of interrupt processing. The arbitration result is a constant that the CPU uses to determine which vector to fetch. Once an interrupt is latched by the SIM, no other interrupt may take precedence, regardless of priority, until the latched interrupt is serviced (or the I bit is cleared). (See [Figure 9-10. Interrupt Processing.](#))

### 9.6.1.1 Hardware Interrupts

A hardware interrupt does not stop the current instruction. Processing of a hardware interrupt begins after completion of the current instruction. When the current instruction is complete, the SIM checks all pending hardware interrupts. If interrupts are not masked (I bit clear in the condition code register), and if the corresponding interrupt enable bit is set, the SIM proceeds with interrupt processing; otherwise, the next instruction is fetched and executed.

If more than one interrupt is pending at the end of an instruction execution, the highest priority interrupt is serviced first. [Figure 9-11](#) demonstrates what happens when two interrupts are pending. If an interrupt is pending upon exit from the original interrupt service routine, the pending interrupt is serviced before the LDA instruction is executed.

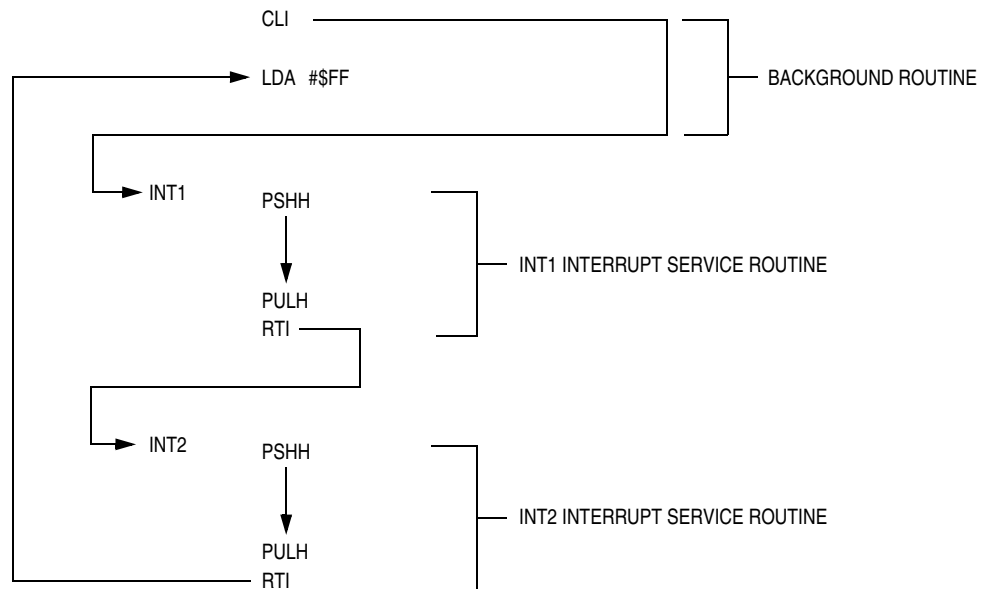

**Figure 9-11. Interrupt Recognition Example**

The LDA opcode is pre-fetched by both the INT1 and INT2 RTI instructions. However, in the case of the INT1 RTI pre-fetch, this is a redundant operation.

**NOTE:** *To maintain compatibility with the M6805 Family, the H register is not pushed on the stack during interrupt entry. If the interrupt service routine modifies the H register or uses the indexed addressing mode, software should save the H register and then restore it prior to exiting the routine.*

#### 9.6.1.2 SWI Instruction

The SWI instruction is a non-maskable instruction that causes an interrupt regardless of the state of the interrupt mask (I bit) in the condition code register.

**NOTE:** *A software interrupt pushes PC onto the stack. A software interrupt does not push PC – 1, as a hardware interrupt does.*

### 9.6.2 Interrupt Status Registers

The flags in the interrupt status registers identify maskable interrupt sources. **Table 9-3** summarizes the interrupt sources and the interrupt status register flags that they set. The interrupt status registers can be useful for debugging.

**Table 9-3. Interrupt Sources**

Source	Flag	Mask <sup>(1)</sup>	INT Register Flag	Priority <sup>(2)</sup>	Vector Address
Reset	None	None	None	0	\$FFFE-\$FFFF
SWI Instruction	None	None	None	0	\$FFFC-\$FFFD
$\overline{\text{IRQ}}$ pin	IRQF	IMASK	IF1	1	\$FFFA-\$FFFB
HUB start of frame	SOFF	SOFIE	IF2	2	\$FFF8-\$FFF9
HUB 2nd end of frame point	EOF2F	EOF2IE			
HUB end of packet	EOPF	EOPIE			
HUB bus signal transition detect	TRANF	TRANIE			
HUB endpoint 0 transmit	TXDF	TXDIE	IF3	3	\$FFF6-\$FFF7
HUB endpoint 0 receive	RXDF	RXDIE			
Device endpoint 0 transmit	TXD0F	TXD0IE	IF4	4	\$FFF4-\$FFF5
Device endpoint 0 receive	RXD0F	RXD0IE			
USB endpoint1/2 transmit	TXD1F	TXD1IE			
DDC12AB	ALIF	DIEN	IF5	5	\$FFF2-\$FFF3
	NAKIF				
	RXIF				
	TXIF				
	SCLIF	SCLIEN			
TIM channel 0	CH0F	CH0IE	IF6	6	\$FFF0-\$FFF1
TIM channel 1	CH1F	CH1IE	IF7	7	\$FFEE-\$FFEF
TIM overflow	TOF	TOIE	IF8	8	\$FFEC-\$FFED
Sync processor	VSIF	VSIE	IF9	9	\$FFEA-\$FFEB
	LVSIF	LVSIE			
Multi-master IIC	MMALIF	MMIEN	IF10	10	\$FFE8-\$FFE9
	MMNAKIF				
	MMRXIF				
	MMTXIF				
On-screen display	DENDIF	OSDIE	IF11	11	\$FFE6-\$FFE7
ADC conversion complete	COCO	AIEN	IF12	12	\$FFE4-\$FFE5
Keyboard Interrupt	KEYF	KBIE7-KBIE0	IF13	13	\$FFE2-\$FFE3
CGM PLL	PLLF	PLLIE	IF14	14	\$FFE0-\$FFE1

**Notes:**

1. The I bit in the condition code register is a global mask for all interrupt sources except the SWI instruction.
2. Highest priority = 0.



### 9.6.2.1 Interrupt Status Register 1

Address: \$FE04

	Bit 7	6	5	4	3	2	1	Bit 0
Read:	IF6	IF5	IF4	IF3	IF2	IF1	0	0
Write:	R	R	R	R	R	R	R	R
Reset:	0	0	0	0	0	0	0	0

R = Reserved

**Figure 9-12. Interrupt Status Register 1 (INT1)**

#### IF6–IF1 — Interrupt Flags 6–1

These flags indicate the presence of interrupt requests from the sources shown in [Table 9-3](#).

1 = Interrupt request present

0 = No interrupt request present

#### Bit 1 and Bit 0 — Always read 0

### 9.6.2.2 Interrupt Status Register 2

Address: \$FE05

	Bit 7	6	5	4	3	2	1	Bit 0
Read:	IF14	IF13	IF12	IF11	IF10	IF9	IF8	IF7
Write:	R	R	R	R	R	R	R	R
Reset:	0	0	0	0	0	0	0	0

R = Reserved

**Figure 9-13. Interrupt Status Register 2 (INT2)**

#### IF14–IF7 — Interrupt Flags 14–7

These flags indicate the presence of interrupt requests from the sources shown in [Table 9-3](#).

1 = Interrupt request present

0 = No interrupt request present

### 9.6.3 Reset

All reset sources always have equal and highest priority and cannot be arbitrated.

### 9.6.4 Break Interrupts

The break module can stop normal program flow at a software-programmable break point by asserting its break interrupt output (see [Section 23. Break Module \(BRK\)](#)). The SIM puts the CPU into the break state by forcing it to the SWI vector location. Refer to the break interrupt subsection of each module to see how each module is affected by the break state.

### 9.6.5 Status Flag Protection in Break Mode

The SIM controls whether status flags contained in other modules can be cleared during break mode. The user can select whether flags are protected from being cleared by properly initializing the break clear flag enable bit (BCFE) in the SIM break flag control register (SBFCR).

Protecting flags in break mode ensures that set flags will not be cleared while in break mode. This protection allows registers to be freely read and written during break mode without losing status flag information.

Setting the BCFE bit enables the clearing mechanisms. Once cleared in break mode, a flag remains cleared even when break mode is exited. Status flags with a two-step clearing mechanism — for example, a read of one register followed by the read or write of another — are protected, even when the first step is accomplished prior to entering break mode. Upon leaving break mode, execution of the second step will clear the flag as normal.

## 9.7 Low-Power Modes

Executing the WAIT or STOP instruction puts the MCU in a low-power-consumption mode for standby situations. The SIM holds the CPU in a non-clocked state. The operation of each of these modes is described below. Both STOP and WAIT clear the interrupt mask (I) in the condition code register, allowing interrupts to occur.

### 9.7.1 Wait Mode

In wait mode, the CPU clocks are inactive while the peripheral clocks continue to run. **Figure 9-14** shows the timing for wait mode entry.

A module that is active during wait mode can wake up the CPU with an interrupt if the interrupt is enabled. Stacking for the interrupt begins one cycle after the WAIT instruction during which the interrupt occurred. In wait mode, the CPU clocks are inactive. Refer to the wait mode subsection of each module to see if the module is active or inactive in wait mode. Some modules can be programmed to be active in wait mode.

Wait mode can also be exited by a reset or break. A break interrupt during wait mode sets the SIM break stop/wait bit, SBSW, in the SIM break status register (SBSR). If the COP disable bit, COPD, in configuration register (CONFIG) is logic zero, then the computer operating properly module (COP) is enabled and remains active in wait mode.

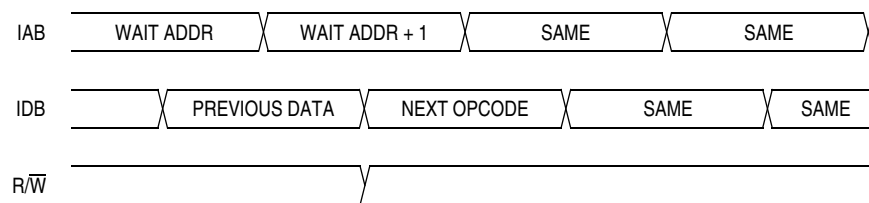

NOTE: Previous data can be operand data or the WAIT opcode, depending on the last instruction.

**Figure 9-14. Wait Mode Entry Timing**

**Figure 9-15** and **Figure 9-16** show the timing for WAIT recovery.

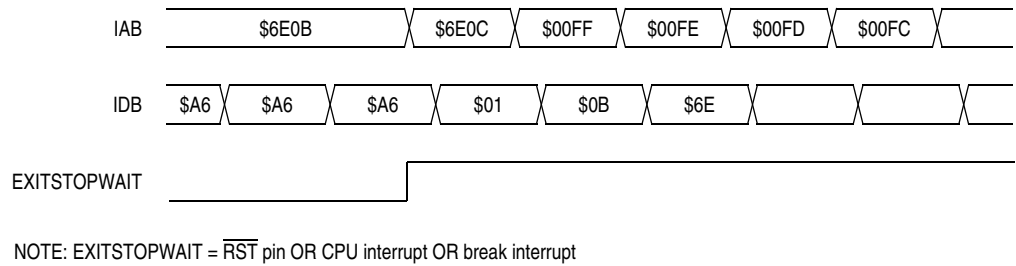

**Figure 9-15. Wait Recovery from Interrupt or Break**

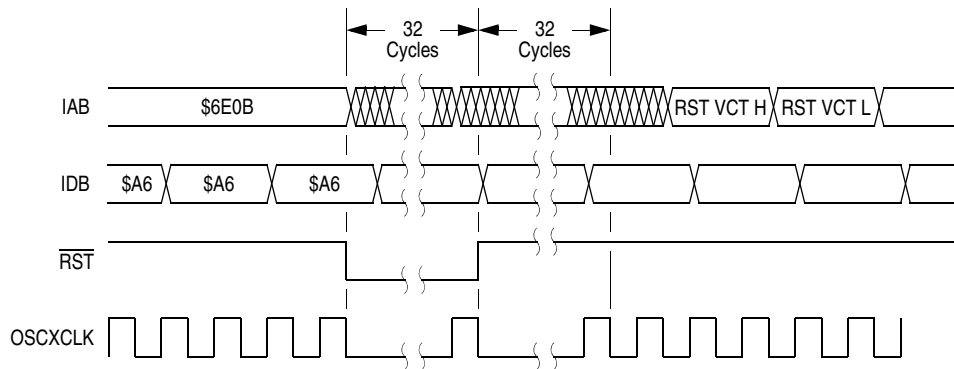

**Figure 9-16. Wait Recovery from Internal Reset**

## 9.7.2 Stop Mode

In stop mode, the SIM counter is reset and the system clocks are disabled. An interrupt request from a module can cause an exit from stop mode. Stacking for interrupts begins after the selected stop recovery time has elapsed. Reset or break also causes an exit from stop mode.

The SIM disables the oscillator signals (OSCOOUT and OSCXCLK) in stop mode, stopping the CPU and peripherals. Stop recovery time is selectable using the SSREC bit in configuration register (CONFIG). If SSREC is set, stop recovery is reduced from the normal delay of 4096 OSCXCLK cycles down to 32. This is ideal for applications using canned oscillators that do not require long start-up times from stop mode.

**NOTE:** *External crystal applications should use the full stop recovery time by clearing the SSREC bit.*

A break interrupt during stop mode sets the SIM break stop/wait bit (SBSW) in the SIM break status register (SBSR).

The SIM counter is held in reset from the execution of the STOP instruction until the beginning of stop recovery. It is then used to time the recovery period. **Figure 9-17** shows stop mode entry timing.

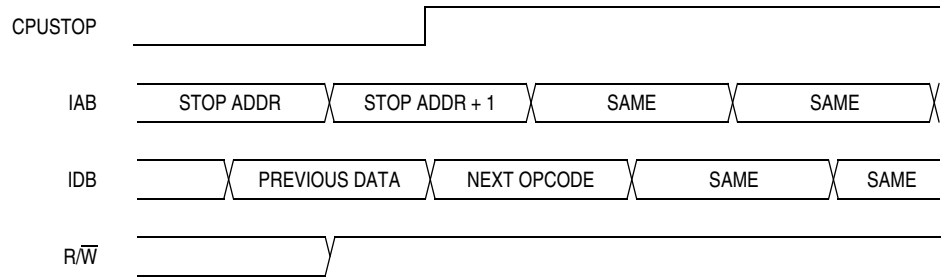

NOTE: Previous data can be operand data or the STOP opcode, depending on the last instruction.

**Figure 9-17. Stop Mode Entry Timing**

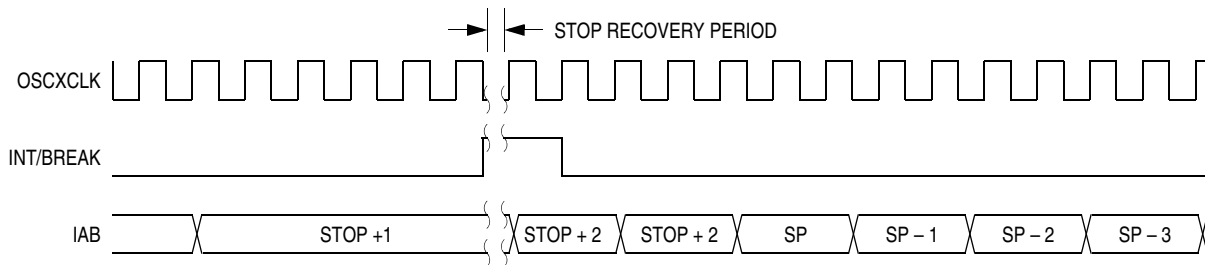

**Figure 9-18. Stop Mode Recovery from Interrupt or Break**

## 9.8 SIM Registers

The SIM has three memory mapped registers. [Table 9-4](#) shows the mapping of these registers.

**Table 9-4. SIM Registers Summary**

Address	Register	Access Mode
\$FE00	SBSR	User
\$FE01	SRSR	User
\$FE03	SBFCR	User

### 9.8.1 SIM Break Status Register (SBSR)

The SIM break status register contains a flag to indicate that a break caused an exit from stop or wait mode.

Address: \$FE00

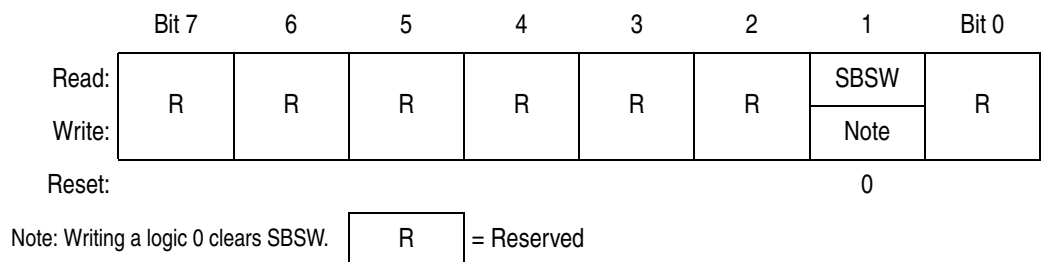

**Figure 9-19. SIM Break Status Register (SBSR)**

#### SBSW — SIM Break Stop/Wait Bit

This status bit is useful in applications requiring a return to wait or stop mode after exiting from a break interrupt. Clear SBSW by writing a logic 0 to it. Reset clears SBSW.

- 1 = Stop mode or wait mode was exited by break interrupt
- 0 = Stop mode or wait mode was not exited by break interrupt

SBSW can be read within the break interrupt routine. The user can modify the return address on the stack by subtracting one from it. The following code is an example.

```

;This code works if the H register has been pushed onto the stack in the break
;service routine software. This code should be executed at the end of the break
;service routine software.

HIBYTE EQU 5
LOBYTE EQU 6

; If not SBSW, do RTI

BRCLR SBSW,SBSR, RETURN ;See if wait mode or stop mode was exited by
;break.

TST LOBYTE,SP ;If RETURNLO is not zero,
BNE DOLO ;then just decrement low byte.
DEC HIBYTE,SP ;Else deal with high byte, too.
DOLO DEC LOBYTE,SP ;Point to WAIT/STOP opcode.
RETURN PULH ;Restore H register.
RTI

```

### 9.8.2 SIM Reset Status Register (SRSR)

This register contains six flags that show the source of the last reset. Clear the SIM reset status register by reading it. A power-on reset sets the POR bit and clears all other bits in the register.

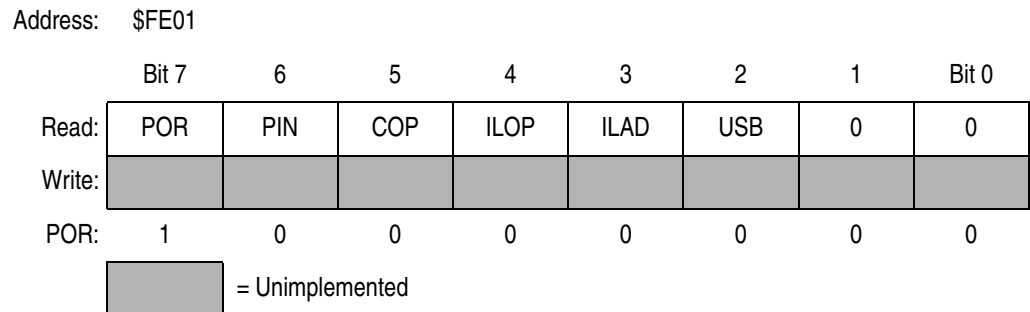

**Figure 9-20. SIM Reset Status Register (SRSR)**

**POR** — Power-On Reset Bit

- 1 = Last reset caused by POR circuit
- 0 = Read of SRSR

**PIN** — External Reset Bit

- 1 = Last reset caused by external reset pin ( $\overline{RST}$ )
- 0 = POR or read of SRSR

COP — Computer Operating Properly Reset Bit

1 = Last reset caused by COP counter

0 = POR or read of SRSR

ILOP — Illegal Opcode Reset Bit

1 = Last reset caused by an illegal opcode

0 = POR or read of SRSR

ILAD — Illegal Address Reset Bit (opcode fetches only)

1 = Last reset caused by an opcode fetch from an illegal address

0 = POR or read of SRSR

USB — Universal Serial Bus Reset Bit

1 = Last reset caused by an USB module

0 = POR or read of SRSR

### 9.8.3 SIM Break Flag Control Register (SBFCR)

The SIM break flag control register contains a bit that enables software to clear status bits while the MCU is in a break state.

Address: \$FE03

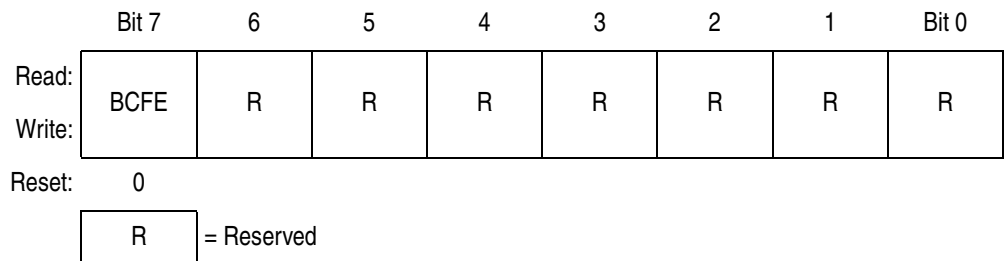

**Figure 9-21. SIM Break Flag Control Register (SBFCR)**

BCFE — Break Clear Flag Enable Bit

This read/write bit enables software to clear status bits by accessing status registers while the MCU is in a break state. To clear status bits during the break state, the BCFE bit must be set.

1 = Status bits clearable during break

0 = Status bits not clearable during break



## Section 10. Monitor ROM (MON)

### 10.1 Contents

10.2	Introduction .....	137
10.3	Features .....	138
10.4	Functional Description .....	138
10.4.1	Entering Monitor Mode .....	140
10.4.2	Data Format .....	142
10.4.3	Echoing .....	143
10.4.4	Break Signal .....	143
10.4.5	Commands .....	144
10.4.6	Baud Rate .....	147

### 10.2 Introduction

This section describes the monitor ROM (MON) and the monitor mode entry methods. The monitor ROM allows complete testing of the MCU through a single-wire interface with a host computer. Monitor mode entry can be achieved without use of the higher test voltage,  $V_{TST}$ , as long as vector addresses \$FFFE and \$FFFF are blank, thus reducing the hardware requirements for in-circuit programming.

## 10.3 Features

Features of the monitor ROM include:

- Normal user-mode pin functionality
- One pin dedicated to serial communication between monitor ROM and host computer
- Standard mark/space non-return-to-zero (NRZ) communication with host computer
- Execution of code in RAM or FLASH
- FLASH memory security feature<sup>1</sup>
- FLASH memory programming interface
- 1024 bytes monitor ROM code size (\$FA00 to \$FDFF)
- Monitor mode entry without high voltage,  $V_{TST}$ , if reset vector is blank (\$FFFE and \$FFFF contain \$FF)
- Standard monitor mode entry if high voltage,  $V_{TST}$ , is applied to  $\overline{IRQ}$

## 10.4 Functional Description

The monitor ROM receives and executes commands from a host computer. **Figure 10-1** shows a sample circuit used to enter monitor mode and communicate with a host computer via a standard RS-232 interface.

Simple monitor commands can access any memory address. In monitor mode, the MCU can execute code downloaded into RAM by a host computer while most MCU pins retain normal operating mode functions. All communication between the host computer and the MCU is through the PTA0 pin. A level-shifting and multiplexing interface is required between PTA0 and the host computer. PTA0 is used in a wired-OR configuration and requires a pull-up resistor.

<sup>1</sup> No security feature is absolutely secure. However, Freescale's strategy is to make reading or copying the FLASH difficult for unauthorized users.

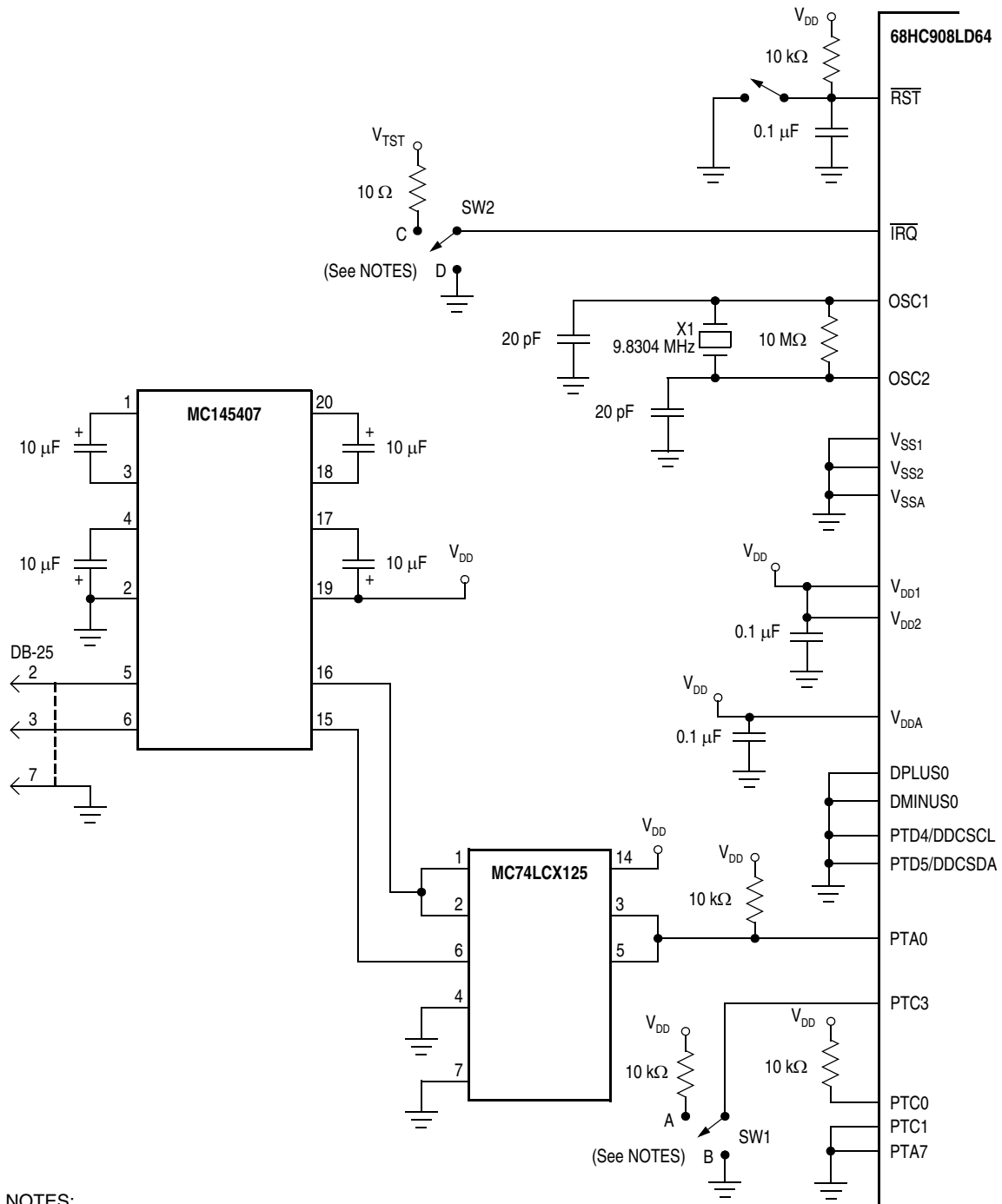

NOTES:

- SW2: Position C — For monitor mode entry when  $\overline{IRQ} = V_{TST}$ :  
SW1: Position A — Bus clock =  $OSCCLK \div 4$   
SW1: Position B — Bus clock =  $OSCCLK \div 2$
- SW2: Position D — For monitor mode entry when reset vector is blank (\$FFFE and \$FFFF = \$FF):  
Bus clock =  $OSCCLK \div 4$ ; PTC0, PTC1, and PTC3 voltages are not required.
- See [Table 24-4](#) for  $\overline{IRQ}$  voltage level requirements.

Figure 10-1. Monitor Mode Circuit

## 10.4.1 Entering Monitor Mode

**Table 10-1** shows the pin conditions for entering monitor mode. As specified in the table, monitor mode may be entered after a power-on reset (POR) and will allow communication at 9600 baud provided one of the following sets of conditions is met:

1. If monitor entry is by high voltage on  $\overline{IRQ}$  ( $\overline{IRQ} = V_{TST}$ )
  - The external clock is 4.9152 MHz with PTC3 low or 9.8304 MHz with PTC3 high
2. If monitor entry is by blank reset vector (\$FFFE and \$FFFF both contain \$FF; erased state):
  - The external clock is 9.8304 MHz

**NOTE:** *Holding the PTC3 pin low when entering monitor mode by a high voltage causes a bypass of a divide-by-two stage at the oscillator. The OSCOUT frequency is equal to the OSCXCLK frequency, and the OSC1 input directly generates internal bus clocks. In this case, the OSC1 signal must have a 50% duty cycle at maximum bus frequency.*

**NOTE:** *If the reset vector is blank and monitor mode is entered, the chip will see an additional reset cycle after the initial POR reset. Once the part has been programmed, the traditional method of applying a high voltage,  $V_{TST}$ , to  $\overline{IRQ}$  must be used to enter monitor mode.*

Enter monitor mode with the pin configuration shown in **Table 10-1** after a reset. The rising edge of reset latches monitor mode. Once monitor mode is latched, the values on the specified pins can change.

Once out of reset, the MCU monitor mode firmware then sends a break signal (10 consecutive logic zeros) to the host computer, indicating that it is ready to receive a command. The break signal also provides a timing reference to allow the host to determine the necessary baud rate.

**Table 10-1. Monitor Mode Signal Requirements and Options**

IRQ	RST	Address \$FFFE/ \$FFFF	PTC3	PTC1	PTC0	PTA7 <sup>(1)</sup>	DPLUS0 DMINUS0 PTD4 PTD5	External Clock <sup>(2)</sup>	Bus Frequency	COP	Baud Rate	Comment
X	GND	X	X	X	X	X	X	X	0	Disabled	0	No operation until reset goes high.
V <sub>TST</sub>	V <sub>DD</sub> or V <sub>TST</sub>	X	0	0	1	0	0	4.9152 MHz	2.4576 MHz	Disabled	9600	Enters monitor mode. PTC0, PTC1, and PTC3 voltages only required if IRQ = V <sub>TST</sub> ; PTC3 determines frequency divider. Exit monitor mode by POR or by RST low then high
V <sub>TST</sub>	V <sub>DD</sub> or V <sub>TST</sub>	X	1	0	1	0	0	9.8304 MHz	2.4576 MHz	Disabled	9600	Enters monitor mode. PTC0, PTC1, and PTC3 voltages only required if IRQ = V <sub>TST</sub> ; PTC3 determines frequency divider. Exit monitor mode by POR or by RST low then high
V <sub>DD</sub> or GND	V <sub>DD</sub>	Blank "\$FFFF"	X	X	X	0	0	9.8304 MHz	2.4576 MHz	Disabled	9600	Enters monitor mode. External frequency always divided by 4. Exit monitor mode by POR only.
V <sub>DD</sub> or GND	V <sub>DD</sub>	Not Blank	X	X	X	X	X	X	—	Enabled	—	Enters user mode.

**Notes:**

1. PTA7 = 0 if serial communication; PTA7 = 1 if parallel communication
2. External clock is derived by a 4.9152/9.8304 MHz crystal or off-chip oscillator

Monitor mode uses different vectors for reset and SWI. The alternate vectors are in the \$FE page instead of the \$FF page and allow code execution from the internal monitor firmware instead of user code.

When the host computer has completed downloading code into the MCU RAM, This code can be executed by driving PTA0 low while asserting  $\overline{RST}$  low and then high. The internal monitor ROM firmware will interpret the low on PTA0 as an indication to jump to RAM, and execution control will then continue from RAM. Execution of an SWI from the downloaded code will return program control to the internal monitor ROM firmware. Alternatively, the host can send a RUN command, which executes an RTI, and this can be used to send control to the address on the stack pointer.

The COP module is disabled in monitor mode as long as  $V_{TST}$  is applied to the  $\overline{IRQ}$  or the  $\overline{RST}$  pin. (See [Section 9. System Integration Module \(SIM\)](#) for more information on modes of operation.)

**Table 10-2** is a summary of the differences between user mode and monitor mode.

**Table 10-2. Mode Differences**

Modes	Functions				
	COP	Reset Vector High	Reset Vector Low	SWI Vector High	SWI Vector Low
User	Enabled	\$FFFE	\$FFFF	\$FFFC	\$FFFD
Monitor	Disabled <sup>(1)</sup>	\$FEFE	\$FEFF	\$FEFC	\$FEFD

**Notes:**

1. If the high voltage ( $V_{TST}$ ) is removed from the  $\overline{IRQ}$  pin, the SIM asserts its COP enable output. The COP is an option enabled or disabled by the COPD bit in the configuration register.

## 10.4.2 Data Format

Communication with the monitor ROM is in standard non-return-to-zero (NRZ) mark/space data format. (See [Figure 10-2](#) and [Figure 10-3](#).)

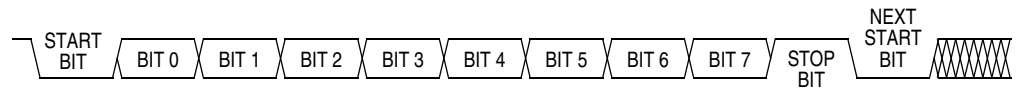

**Figure 10-2. Monitor Data Format**

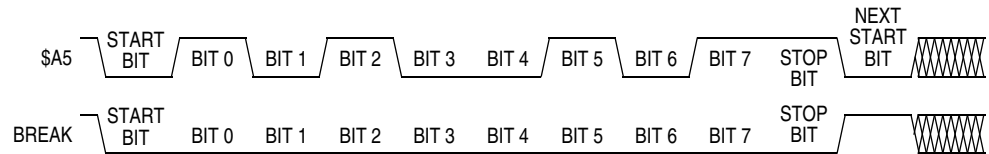
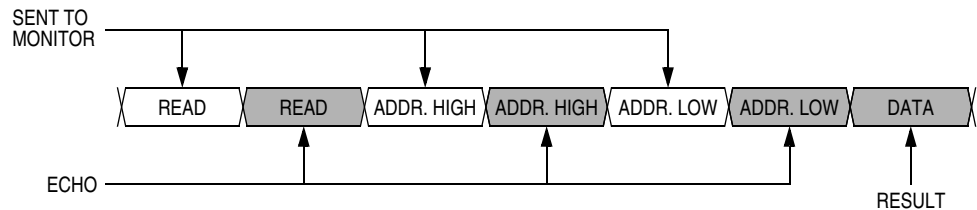

**Figure 10-3. Sample Monitor Waveforms**

The data transmit and receive rate can be anywhere from 4800 baud to 28.8 kbaud. Transmit and receive baud rates must be identical.

### 10.4.3 Echoing

As shown in [Figure 10-4](#), the monitor ROM immediately echoes each received byte back to the PTA0 pin for error checking.

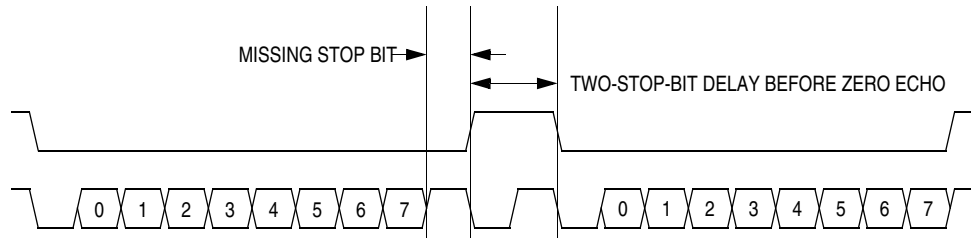

**Figure 10-4. Read Transaction**

Any result of a command appears after the echo of the last byte of the command.

### 10.4.4 Break Signal

A start bit followed by nine low bits is a break signal (see [Figure 10-5](#)). When the monitor receives a break signal, it drives the PTA0 pin high for the duration of two bits before echoing the break signal.



**Figure 10-5. Break Transaction**

## 10.4.5 Commands

The monitor ROM uses the following commands:

- READ (read memory)
- WRITE (write memory)
- IREAD (indexed read)
- IWRITE (indexed write)
- READSP (read stack pointer)
- RUN (run user program)

**Table 10-3. READ (Read Memory) Command**

<b>Description</b>	Read byte from memory
<b>Operand</b>	Specifies 2-byte address in high byte:low byte order
<b>Data Returned</b>	Returns contents of specified address
<b>Opcode</b>	\$4A
<b>Command Sequence</b>	



**Table 10-4. WRITE (Write Memory) Command**

<b>Description</b>	Write byte to memory
<b>Operand</b>	Specifies 2-byte address in high byte:low byte order; low byte followed by data byte
<b>Data Returned</b>	None
<b>Opcode</b>	\$49
<b>Command Sequence</b>	

**Table 10-5. IREAD (Indexed Read) Command**

<b>Description</b>	Read Next 2 Bytes in Memory from Last Address Accessed
<b>Operand</b>	Specifies 2-byte address in high byte:low byte order
<b>Data Returned</b>	Returns contents of next two addresses
<b>Opcode</b>	\$1A
<b>Command Sequence</b>	

**Table 10-6. IWRITE (Indexed Write) Command**

<b>Description</b>	Write to last address accessed + 1
<b>Operand</b>	Specifies single data byte
<b>Data Returned</b>	None
<b>Opcode</b>	\$19
<b>Command Sequence</b>	
<p>The diagram illustrates the command sequence for the IWRITE command. It shows a sequence of four trapezoidal blocks: IWRITE, IWRITE, DATA, and DATA. An arrow labeled 'SENT TO MONITOR' points to the first IWRITE block. Another arrow labeled 'SENT TO MONITOR' points to the first DATA block. An arrow labeled 'ECHO' points to the second IWRITE block. A final arrow labeled 'ECHO' points to the second DATA block.</p>	

A sequence of IREAD or IWRITE commands can sequentially access a block of memory over the full 64K-byte memory map.

**Table 10-7. READSP (Read Stack Pointer) Command**

<b>Description</b>	Reads stack pointer
<b>Operand</b>	None
<b>Data Returned</b>	Returns stack pointer in high byte:low byte order
<b>Opcode</b>	\$0C
<b>Command Sequence</b>	
<p>The diagram illustrates the command sequence for the READSP command. It shows a sequence of four trapezoidal blocks: READSP, READSP, SP HIGH, and SP LOW. An arrow labeled 'SENT TO MONITOR' points to the first READSP block. An arrow labeled 'ECHO' points to the second READSP block. An arrow labeled 'RETURN' points to the SP HIGH block. Another arrow labeled 'RETURN' points to the SP LOW block.</p>	

**Table 10-8. RUN (Run User Program) Command**

<b>Description</b>	Executes RTI instruction
<b>Operand</b>	None
<b>Data Returned</b>	None
<b>Opcode</b>	\$28
<p><b>Command Sequence</b></p>	

### 10.4.6 Baud Rate

The communication baud rate is controlled by crystal frequency and the state of the PTC3 pin upon entry into monitor mode. When PTC3 is high, the divide by ratio is 1024. If the PTC3 pin is at logic zero upon entry into monitor mode, the divide by ratio is 512.

**Table 10-9. Monitor Baud Rate Selection**

Crystal Frequency	PTC3 Pin	Baud Rate
9.8304 MHz	0	19200 bps
9.8304 MHz	1	9600 bps



## Section 11. Timer Interface Module (TIM)

### 11.1 Contents

11.2	Introduction	150
11.3	Features	150
11.4	Pin Name Conventions	150
11.5	Functional Description	151
11.5.1	TIM Counter Prescaler	153
11.5.2	Input Capture	153
11.5.3	Output Compare	153
11.5.3.1	Unbuffered Output Compare	154
11.5.3.2	Buffered Output Compare	155
11.5.4	Pulse Width Modulation (PWM)	155
11.5.4.1	Unbuffered PWM Signal Generation	156
11.5.4.2	Buffered PWM Signal Generation	157
11.5.4.3	PWM Initialization	158
11.6	Interrupts	159
11.7	Low-Power Modes	159
11.7.1	Wait Mode	159
11.7.2	Stop Mode	160
11.8	TIM During Break Interrupts	160
11.9	I/O Signals	160
11.10	I/O Registers	161
11.10.1	TIM Status and Control Register (TSC)	161
11.10.2	TIM Counter Registers (TCNTH:TCNTL)	163
11.10.3	TIM Counter Modulo Registers (TMODH:TMODL)	164
11.10.4	TIM Channel Status and Control Registers (TSC0:TSC1)	165
11.10.5	TIM Channel Registers (TCH0H/L:TCH1H/L)	168

## 11.2 Introduction

This section describes the timer interface module (TIM2, Version B). The TIM is a two-channel timer that provides a timing reference with input capture, output compare, and pulse-width-modulation functions.

**Figure 11-1** is a block diagram of the TIM.

## 11.3 Features

Features of the TIM include the following:

- Two input capture/output compare channels
  - Rising-edge, falling-edge, or any-edge input capture trigger
  - Set, clear, or toggle output compare action
- Buffered and unbuffered pulse width modulation (PWM) signal generation
- Programmable TIM clock input
  - Seven-frequency internal bus clock prescaler selection
- Free-running or modulo up-count operation
- Toggle any channel pin on overflow
- TIM counter stop and reset bits

**NOTE:** *TCH1 (timer channel 1) is not bonded to an external pin on this MCU. Therefore, any references to the timer TCH1 pin in the following text should be interpreted as not available — but the internal status and control registers are still available.*

## 11.4 Pin Name Conventions

The TIM shares the TCH0 pin with the sync processor CLAMP output.

**Table 11-1. Pin Name Conventions**

<b>TIM Generic Pin Name:</b>	<b>TCH0</b>
<b>Full TIM Pin Name:</b>	CLAMP/TCH0
<b>Pin Selected for TCH0 By:</b>	ELS0B:ELS0A

## 11.5 Functional Description

**Figure 11-1** shows the structure of the TIM. The central component of the TIM is the 16-bit TIM counter that can operate as a free-running counter or a modulo up-counter. The TIM counter provides the timing reference for the input capture and output compare functions. The TIM counter modulo registers, TMODH:TMODL, control the modulo value of the TIM counter. Software can read the TIM counter value at any time without affecting the counting sequence.

The two TIM channels are programmable independently as input capture or output compare channels.

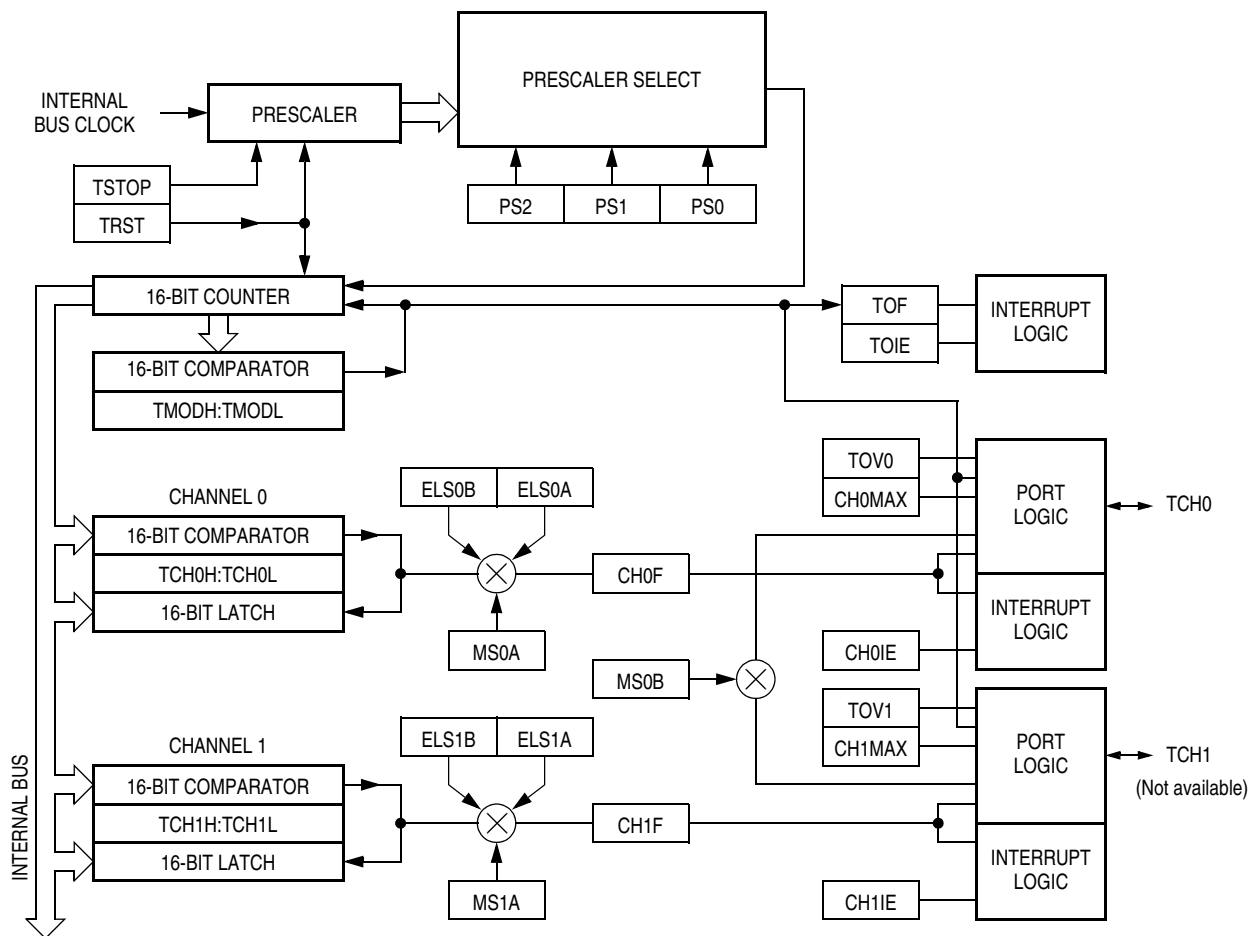

**Figure 11-1. TIM Block Diagram**

# Timer Interface Module (TIM)

Addr.	Register Name	Bit 7	6	5	4	3	2	1	Bit 0	
\$000A	TIM Status and Control Register (TSC)	Read:	TOF	TOIE	TSTOP	0	0	PS2	PS1	PS0
		Write:	0			TRST				
		Reset:	0	0	1	0	0	0	0	0
\$000C	TIM Counter Register High (TCNTH)	Read:	Bit15	Bit14	Bit13	Bit12	Bit11	Bit10	Bit9	Bit8
		Write:								
		Reset:	0	0	0	0	0	0	0	0
\$000D	TIM Counter Register Low (TCNTL)	Read:	Bit7	Bit6	Bit5	Bit4	Bit3	Bit2	Bit1	Bit0
		Write:								
		Reset:	0	0	0	0	0	0	0	0
\$000E	TIM Counter Modulo Register High (TMODH)	Read:	Bit15	Bit14	Bit13	Bit12	Bit11	Bit10	Bit9	Bit8
		Write:								
		Reset:	1	1	1	1	1	1	1	1
\$000F	TIM Counter Modulo Register Low (TMODL)	Read:	Bit7	Bit6	Bit5	Bit4	Bit3	Bit2	Bit1	Bit0
		Write:								
		Reset:	1	1	1	1	1	1	1	1
\$0010	TIM Channel 0 Status and Control Register (TSC0)	Read:	CH0F	CH0IE	MS0B	MS0A	ELS0B	ELS0A	TOV0	CH0MAX
		Write:	0							
		Reset:	0	0	0	0	0	0	0	0
\$0011	TIM Channel 0 Register High (TCH0H)	Read:	Bit15	Bit14	Bit13	Bit12	Bit11	Bit10	Bit9	Bit8
		Write:								
		Reset:	Indeterminate after reset							
\$0012	TIM Channel 0 Register Low (TCH0L)	Read:	Bit7	Bit6	Bit5	Bit4	Bit3	Bit2	Bit1	Bit0
		Write:								
		Reset:	Indeterminate after reset							
\$0013	TIM Channel 1 Status and Control Register (TSC1)	Read:	CH1F	CH1IE	0	MS1A	ELS1B	ELS1A	TOV1	CH1MAX
		Write:	0							
		Reset:	0	0	0	0	0	0	0	0



Addr.	Register Name	Bit 7	6	5	4	3	2	1	Bit 0	
\$0014	TIM Channel 1 Register High (TCH1H)	Read:	Bit15	Bit14	Bit13	Bit12	Bit11	Bit10	Bit9	Bit8
		Write:								
		Reset:	Indeterminate after reset							
\$0015	TIM Channel 1 Register Low (TCH1L)	Read:	Bit7	Bit6	Bit5	Bit4	Bit3	Bit2	Bit1	Bit0
		Write:								
		Reset:	Indeterminate after reset							

 = Unimplemented

### 11.5.1 TIM Counter Prescaler

The TIM clock source can be one of the seven prescaler outputs. The prescaler generates seven clock rates from the internal bus clock. The prescaler select bits, PS[2:0], in the TIM status and control register (TSC) select the TIM clock source.

### 11.5.2 Input Capture

With the input capture function, the TIM can capture the time at which an external event occurs. When an active edge occurs on the pin of an input capture channel, the TIM latches the contents of the TIM counter into the TIM channel registers, TCHxH:TCHxL. The polarity of the active edge is programmable. Input captures can generate TIM CPU interrupt requests.

### 11.5.3 Output Compare

With the output compare function, the TIM can generate a periodic pulse with a programmable polarity, duration, and frequency. When the counter reaches the value in the registers of an output compare channel, the TIM can set, clear, or toggle the channel pin. Output compares can generate TIM CPU interrupt requests.

### 11.5.3.1 Unbuffered Output Compare

Any output compare channel can generate unbuffered output compare pulses as described in [11.5.3 Output Compare](#). The pulses are unbuffered because changing the output compare value requires writing the new value over the old value currently in the TIM channel registers.

An unsynchronized write to the TIM channel registers to change an output compare value could cause incorrect operation for up to two counter overflow periods. For example, writing a new value before the counter reaches the old value but after the counter reaches the new value prevents any compare during that counter overflow period. Also, using a TIM overflow interrupt routine to write a new, smaller output compare value may cause the compare to be missed. The TIM may pass the new value before it is written.

Use the following methods to synchronize unbuffered changes in the output compare value on channel x:

- When changing to a smaller value, enable channel x output compare interrupts and write the new value in the output compare interrupt routine. The output compare interrupt occurs at the end of the current output compare pulse. The interrupt routine has until the end of the counter overflow period to write the new value.
- When changing to a larger output compare value, enable TIM overflow interrupts and write the new value in the TIM overflow interrupt routine. The TIM overflow interrupt occurs at the end of the current counter overflow period. Writing a larger value in an output compare interrupt routine (at the end of the current pulse) could cause two output compares to occur in the same counter overflow period.

### 11.5.3.2 Buffered Output Compare

Channels 0 and 1 can be linked to form a buffered output compare channel whose output appears on the TCH0 pin. The TIM channel registers of the linked pair alternately control the output.

Setting the MS0B bit in TIM channel 0 status and control register (TSC0) links channel 0 and channel 1. The output compare value in the TIM channel 0 registers initially controls the output on the TCH0 pin. Writing to the TIM channel 1 registers enables the TIM channel 1 registers to synchronously control the output after the TIM overflows. At each subsequent overflow, the TIM channel registers (0 or 1) that control the output are the ones written to last. TSC0 controls and monitors the buffered output compare function, and TIM channel 1 status and control register (TSC1) is unused.

**NOTE:** *In buffered output compare operation, do not write new output compare values to the currently active channel registers. User software should track the currently active channel to prevent writing a new value to the active channel. Writing to the active channel registers is the same as generating unbuffered output compares.*

### 11.5.4 Pulse Width Modulation (PWM)

By using the toggle-on-overflow feature with an output compare channel, the TIM can generate a PWM signal. The value in the TIM counter modulo registers determines the period of the PWM signal. The channel pin toggles when the counter reaches the value in the TIM counter modulo registers. The time between overflows is the period of the PWM signal.

As [Figure 11-2](#) shows, the output compare value in the TIM channel registers determines the pulse width of the PWM signal. The time between overflow and output compare is the pulse width. Program the TIM to clear the channel pin on output compare if the state of the PWM pulse is logic one. Program the TIM to set the pin if the state of the PWM pulse is logic zero.

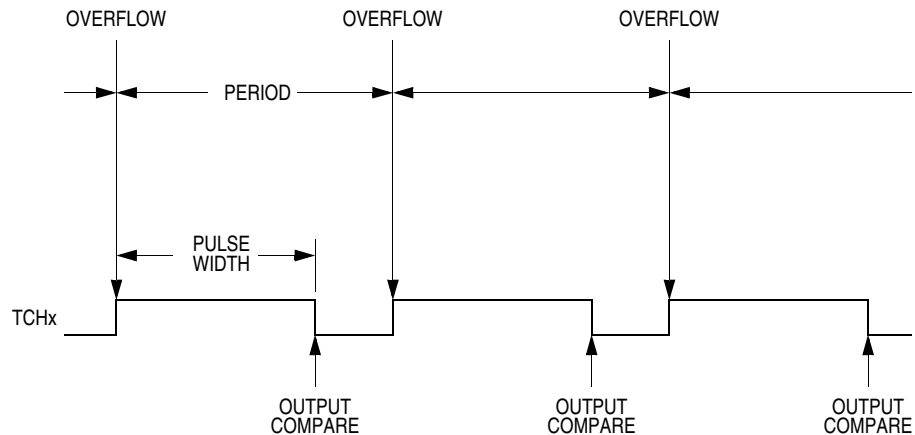

**Figure 11-2. PWM Period and Pulse Width**

The value in the TIM counter modulo registers and the selected prescaler output determines the frequency of the PWM output. The frequency of an 8-bit PWM signal is variable in 256 increments. Writing \$00FF (255) to the TIM counter modulo registers produces a PWM period of 256 times the internal bus clock period if the prescaler select value is 000 (see [11.10.1 TIM Status and Control Register \(TSC\)](#)).

The value in the TIM channel registers determines the pulse width of the PWM output. The pulse width of an 8-bit PWM signal is variable in 256 increments. Writing \$0080 (128) to the TIM channel registers produces a duty cycle of 128/256 or 50%.

### 11.5.4.1 Unbuffered PWM Signal Generation

Any output compare channel can generate unbuffered PWM pulses as described in [11.5.4 Pulse Width Modulation \(PWM\)](#). The pulses are unbuffered because changing the pulse width requires writing the new pulse width value over the old value currently in the TIM channel registers.

An unsynchronized write to the TIM channel registers to change a pulse width value could cause incorrect operation for up to two PWM periods. For example, writing a new value before the counter reaches the old value but after the counter reaches the new value prevents any compare during that PWM period. Also, using a TIM overflow interrupt routine to write a new, smaller pulse width value may cause the compare to be missed. The TIM may pass the new value before it is written.

Use the following methods to synchronize unbuffered changes in the PWM pulse width on channel x:

- When changing to a shorter pulse width, enable channel x output compare interrupts and write the new value in the output compare interrupt routine. The output compare interrupt occurs at the end of the current pulse. The interrupt routine has until the end of the PWM period to write the new value.
- When changing to a longer pulse width, enable TIM overflow interrupts and write the new value in the TIM overflow interrupt routine. The TIM overflow interrupt occurs at the end of the current PWM period. Writing a larger value in an output compare interrupt routine (at the end of the current pulse) could cause two output compares to occur in the same PWM period.

**NOTE:** *In PWM signal generation, do not program the PWM channel to toggle on output compare. Toggling on output compare prevents reliable 0% duty cycle generation and removes the ability of the channel to self-correct in the event of software error or noise. Toggling on output compare also can cause incorrect PWM signal generation when changing the PWM pulse width to a new, much larger value.*

#### 11.5.4.2 Buffered PWM Signal Generation

Channels 0 and 1 can be linked to form a buffered PWM channel whose output appears on the TCH0 pin. The TIM channel registers of the linked pair alternately control the pulse width of the output.

Setting the MS0B bit in TIM channel 0 status and control register (TSC0) links channel 0 and channel 1. The TIM channel 0 registers initially control the pulse width on the TCH0 pin. Writing to the TIM channel 1 registers enables the TIM channel 1 registers to synchronously control the pulse width at the beginning of the next PWM period. At each subsequent overflow, the TIM channel registers (0 or 1) that control the pulse width are the ones written to last. TSC0 controls and monitors the buffered PWM function, and TIM channel 1 status and control register (TSC1) is unused. While the MS0B bit is set, the channel 1 pin, TCH1, is available as a general-purpose I/O pin.

**NOTE:** *In buffered PWM signal generation, do not write new pulse width values to the currently active channel registers. User software should track the currently active channel to prevent writing a new value to the active channel. Writing to the active channel registers is the same as generating unbuffered PWM signals.*

### 11.5.4.3 PWM Initialization

To ensure correct operation when generating unbuffered or buffered PWM signals, use the following initialization procedure:

1. In the TIM status and control register (TSC):
  - a. Stop the TIM counter by setting the TIM stop bit, TSTOP.
  - b. Reset the TIM counter and prescaler by setting the TIM reset bit, TRST.
2. In the TIM counter modulo registers (TMODH:TMODL), write the value for the required PWM period.
3. In the TIM channel x registers (TCHxH:TCHxL), write the value for the required pulse width.
4. In TIM channel x status and control register (TSCx):
  - a. Write 0:1 (for unbuffered output compare or PWM signals) or 1:0 (for buffered output compare or PWM signals) to the mode select bits, MSxB:MSxA. (See [Table 11-3](#).)
  - b. Write 1 to the toggle-on-overflow bit, TOVx.
  - c. Write 1:0 (to clear output on compare) or 1:1 (to set output on compare) to the edge/level select bits, ELSxB:ELSxA. The output action on compare must force the output to the complement of the pulse width level. (See [Table 11-3](#).)

**NOTE:** *In PWM signal generation, do not program the PWM channel to toggle on output compare. Toggling on output compare prevents reliable 0% duty cycle generation and removes the ability of the channel to self-correct in the event of software error or noise. Toggling on output compare can also cause incorrect PWM signal generation when changing the PWM pulse width to a new, much larger value.*

5. In the TIM status control register (TSC), clear the TIM stop bit, TSTOP.

Setting MS0B links channels 0 and 1 and configures them for buffered PWM operation. The TIM channel 0 registers (TCH0H:TCH0L) initially control the buffered PWM output. TIM channel 0 status and control register (TSC0) controls and monitors the PWM signal from the linked channels.

Clearing the toggle-on-overflow bit, TOVx, inhibits output toggles on TIM overflows. Subsequent output compares try to force the output to a state it is already in and have no effect. The result is a 0% duty cycle output.

Setting the channel x maximum duty cycle bit (CHxMAX) and setting the TOVx bit generates a 100% duty cycle output. See [11.10.4 TIM Channel Status and Control Registers \(TSC0:TSC1\)](#).

## 11.6 Interrupts

The following TIM sources can generate interrupt requests:

- TIM overflow flag (TOF) — The TOF bit is set when the TIM counter reaches the modulo value programmed in the TIM counter modulo registers. The TIM overflow interrupt enable bit, TOIE, enables TIM overflow CPU interrupt requests. TOF and TOIE are in the TIM status and control register.
- TIM channel flags (CH1F:CH0F) — The CHxF bit is set when an input capture or output compare occurs on channel x. Channel x TIM CPU interrupt requests are controlled by the channel x interrupt enable bit, CHxIE. Channel x TIM CPU interrupt requests are enabled when CHxIE=1. CHxF and CHxIE are in the TIM channel x status and control register.

## 11.7 Low-Power Modes

The WAIT and STOP instructions puts the MCU in low-power-consumption standby modes.

### 11.7.1 Wait Mode

The TIM remains active after the execution of a WAIT instruction. In wait mode the TIMA registers are not accessible by the CPU. Any enabled CPU interrupt request from the TIM can bring the MCU out of wait mode.

If TIM functions are not required during wait mode, reduce power consumption by stopping the TIM before executing the WAIT instruction.

## 11.7.2 Stop Mode

The TIM is inactive after the execution of a STOP instruction. The STOP instruction does not affect register conditions or the state of the TIM counter. TIM operation resumes when the MCU exit stop mode after an external interrupt.

## 11.8 TIM During Break Interrupts

A break interrupt stops the TIM counter.

The system integration module (SIM) controls whether status bits in other modules can be cleared during the break state. The BCFE bit in the break flag control register (BFCR) enables software to clear status bits during the break state. (See [23.6.4 SIM Break Flag Control Register](#).)

To allow software to clear status bits during a break interrupt, write a logic one to the BCFE bit. If a status bit is cleared during the break state, it remains cleared when the MCU exits the break state.

To protect status bits during the break state, write a logic zero to the BCFE bit. With BCFE at logic zero (its default state), software can read and write I/O registers during the break state without affecting status bits. Some status bits have a two-step read/write clearing procedure. If software does the first step on such a bit before the break, the bit cannot change during the break state as long as BCFE is at logic zero. After the break, doing the second step clears the status bit.

## 11.9 I/O Signals

The TIM channel I/O pin is CLAMP/TCH0. The pin is shared with sync processor CLAMP output signal.

TCH0 pin is programmable independently as an input capture pin or an output compare pin. It also can be configured as a buffered output compare or buffered PWM pin.



## 11.10 I/O Registers

The following I/O registers control and monitor operation of the TIM:

- TIM status and control register (TSC)
- TIM counter registers (TCNTH:TCNTL)
- TIM counter modulo registers (TMODH:TMODL)
- TIM channel status and control registers (TSC0 and TSC1)
- TIM channel registers (TCH0H:TCH0L and TCH1H:TCH1L)

### 11.10.1 TIM Status and Control Register (TSC)

The TIM status and control register does the following:

- Enables TIM overflow interrupts
- Flags TIM overflows
- Stops the TIM counter
- Resets the TIM counter
- Prescales the TIM counter clock

Address: \$000A

	Bit 7	6	5	4	3	2	1	Bit 0
Read:	TOF	TOIE	TSTOP	0	0	PS2	PS1	PS0
Write:	0			TRST				
Reset:	0	0	1	0	0	0	0	0

 = Unimplemented

**Figure 11-3. TIM Status and Control Register (TSC)**

#### TOF — TIM Overflow Flag Bit

This read/write flag is set when the TIM counter reaches the modulo value programmed in the TIM counter modulo registers. Clear TOF by reading the TIM status and control register when TOF is set and then writing a logic zero to TOF. If another TIM overflow occurs before the clearing sequence is complete, then writing logic zero to TOF has no

effect. Therefore, a TOF interrupt request cannot be lost due to inadvertent clearing of TOF. Reset clears the TOF bit. Writing a logic one to TOF has no effect.

1 = TIM counter has reached modulo value

0 = TIM counter has not reached modulo value

### TOIE — TIM Overflow Interrupt Enable Bit

This read/write bit enables TIM overflow interrupts when the TOF bit becomes set. Reset clears the TOIE bit.

1 = TIM overflow interrupts enabled

0 = TIM overflow interrupts disabled

### TSTOP — TIM Stop Bit

This read/write bit stops the TIM counter. Counting resumes when TSTOP is cleared. Reset sets the TSTOP bit, stopping the TIM counter until software clears the TSTOP bit.

1 = TIM counter stopped

0 = TIM counter active

**NOTE:** *Do not set the TSTOP bit before entering wait mode if the TIM is required to exit wait mode.*

### TRST — TIM Reset Bit

Setting this write-only bit resets the TIM counter and the TIM prescaler. Setting TRST has no effect on any other registers. Counting resumes from \$0000. TRST is cleared automatically after the TIM counter is reset and always reads as logic zero. Reset clears the TRST bit.

1 = Prescaler and TIM counter cleared

0 = No effect

**NOTE:** *Setting the TSTOP and TRST bits simultaneously stops the TIM counter at a value of \$0000.*

### PS[2:0] — Prescaler Select Bits

These read/write bits select either the TCLK pin or one of the seven prescaler outputs as the input to the TIM counter as [Table 11-2](#) shows. Reset clears the PS[2:0] bits.

**Table 11-2. Prescaler Selection**

PS2	PS1	PS0	TIM Clock Source
0	0	0	Internal Bus Clock ÷ 1
0	0	1	Internal Bus Clock ÷ 2
0	1	0	Internal Bus Clock ÷ 4
0	1	1	Internal Bus Clock ÷ 8
1	0	0	Internal Bus Clock ÷ 16
1	0	1	Internal Bus Clock ÷ 32
1	1	0	Internal Bus Clock ÷ 64
1	1	1	Not available

### 11.10.2 TIM Counter Registers (TCNTH:TCNTL)

The two read-only TIM counter registers contain the high and low bytes of the value in the TIM counter. Reading the high byte (TCNTH) latches the contents of the low byte (TCNTL) into a buffer. Subsequent reads of TCNTH do not affect the latched TCNTL value until TCNTL is read. Reset clears the TIM counter registers. Setting the TIM reset bit (TRST) also clears the TIM counter registers.

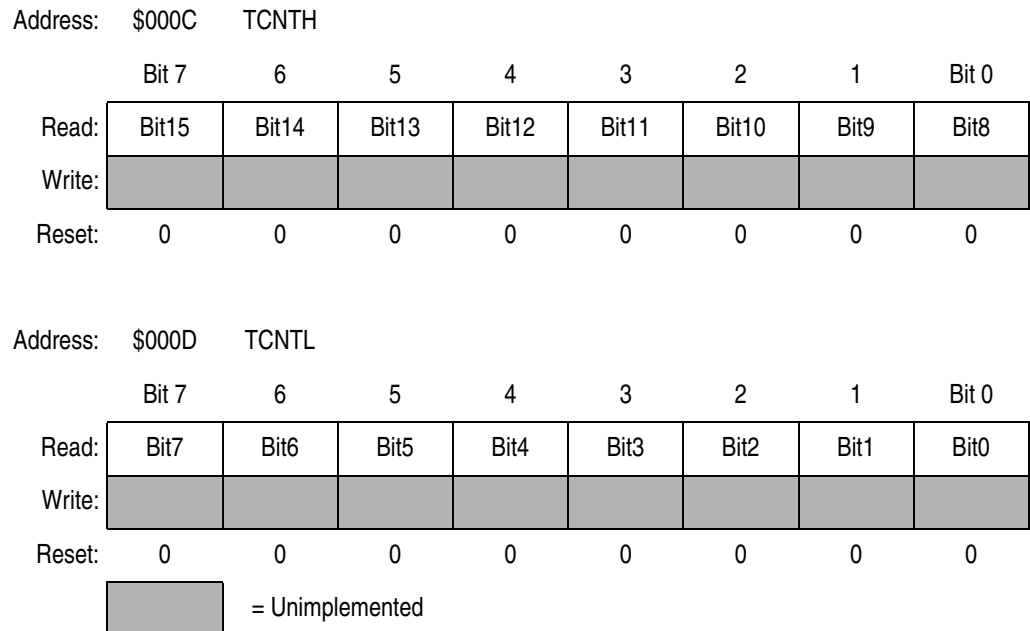

**Figure 11-4. TIM Counter Registers (TCNTH:TCNTL)**

## Timer Interface Module (TIM)

**NOTE:** If you read TCNTH during a break interrupt, be sure to unlatch TCNTL by reading TCNTL before exiting the break interrupt. Otherwise, TCNTL retains the value latched during the break.

### 11.10.3 TIM Counter Modulo Registers (TMODH:TMODL)

The read/write TIM modulo registers contain the modulo value for the TIM counter. When the TIM counter reaches the modulo value, the overflow flag (TOF) becomes set, and the TIM counter resumes counting from \$0000 at the next timer clock. Writing to the high byte (TMODH) inhibits the TOF bit and overflow interrupts until the low byte (TMODL) is written. Reset sets the TIM counter modulo registers.

Address:	\$000E								TMODH							
	Bit 7		6		5		4		3		2		1		Bit 0	
Read:	Bit15		Bit14		Bit13		Bit12		Bit11		Bit10		Bit9		Bit8	
Write:	Bit15		Bit14		Bit13		Bit12		Bit11		Bit10		Bit9		Bit8	
Reset:	1		1		1		1		1		1		1		1	

Address:	\$000F								TMODL							
	Bit 7		6		5		4		3		2		1		Bit 0	
Read:	Bit7		Bit6		Bit5		Bit4		Bit3		Bit2		Bit1		Bit0	
Write:	Bit7		Bit6		Bit5		Bit4		Bit3		Bit2		Bit1		Bit0	
Reset:	1		1		1		1		1		1		1		1	

**Figure 11-5. TIM Counter Modulo Registers (TMODH:TMODL)**

**NOTE:** Reset the TIM counter before writing to the TIM counter modulo registers.

### 11.10.4 TIM Channel Status and Control Registers (TSC0:TSC1)

Each of the TIM channel status and control registers does the following:

- Flags input captures and output compares
- Enables input capture and output compare interrupts
- Selects input capture, output compare, or PWM operation
- Selects high, low, or toggling output on output compare
- Selects rising edge, falling edge, or any edge as the active input capture trigger
- Selects output toggling on TIM overflow
- Selects 0% and 100% PWM duty cycle
- Selects buffered or unbuffered output compare/PWM operation

Address:	\$0010	TSC0							
		Bit 7	6	5	4	3	2	1	Bit 0
Read:	CH0F	CH0IE	MS0B	MS0A	ELS0B	ELS0A	TOV0	CH0MAX	
Write:	0								
Reset:	0	0	0	0	0	0	0	0	0

Address:	\$0013	TSC1							
		Bit 7	6	5	4	3	2	1	Bit 0
Read:	CH1F	CH1IE	0	MS1A	ELS1B	ELS1A	TOV1	CH1MAX	
Write:	0								
Reset:	0	0	0	0	0	0	0	0	0

= Unimplemented

**Figure 11-6. TIM Channel Status and Control Registers (TSC0:TSC1)**

CHx F — Channel x Flag Bit

When channel x is an input capture channel, this read/write bit is set when an active edge occurs on the channel x pin. When channel x is

an output compare channel, CHx $F$  is set when the value in the TIM counter registers matches the value in the TIM channel x registers. When TIM CPU interrupt requests are enabled (CHxIE=1), clear CHx $F$  by reading the TIM channel x status and control register with CHx $F$  set and then writing a logic zero to CHx $F$ . If another interrupt request occurs before the clearing sequence is complete, then writing logic zero to CHx $F$  has no effect. Therefore, an interrupt request cannot be lost due to inadvertent clearing of CHx $F$ .

Reset clears the CHx $F$  bit. Writing a logic one to CHx $F$  has no effect.

- 1 = Input capture or output compare on channel x
- 0 = No input capture or output compare on channel x

### CHxIE — Channel x Interrupt Enable Bit

This read/write bit enables TIM CPU interrupt service requests on channel x. Reset clears the CHxIE bit.

- 1 = Channel x CPU interrupt requests enabled
- 0 = Channel x CPU interrupt requests disabled

### MSxB — Mode Select Bit B

This read/write bit selects buffered output compare/PWM operation. MSxB exists only in the TIM channel 0 status and control register.

Setting MS0B disables the channel 1 status and control register and reverts TCH1 to general-purpose I/O.

Reset clears the MSxB bit.

- 1 = Buffered output compare/PWM operation enabled
- 0 = Buffered output compare/PWM operation disabled

### MSxA — Mode Select Bit A

When ELSxB:A  $\neq$  0:0, this read/write bit selects either input capture operation or unbuffered output compare/PWM operation.

See [Table 11-3](#).

- 1 = Unbuffered output compare/PWM operation
- 0 = Input capture operation

When ELSxB:A = 0:0, this read/write bit selects the initial output level of the TCHx pin. (See [Table 11-3](#).) Reset clears the MSxA bit.

- 1 = Initial output level low
- 0 = Initial output level high

**NOTE:** Before changing a channel function by writing to the MSxB or MSxA bit, set the TSTOP and TRST bits in the TIM status and control register (TSC).

#### ELSxB and ELSxA — Edge/Level Select Bits

When channel x is an input capture channel, these read/write bits control the active edge-sensing logic on channel x.

When channel x is an output compare channel, ELSxB and ELSxA control the channel x output behavior when an output compare occurs.

When ELS0B and ELS0A are both clear, channel 0 is not connected to the CLAMP/TCH0 pin. The pin is available as the CLAMP output of the sync processor.

**Table 11-3** shows how ELSxB and ELSxA work. Reset clears the ELSxB and ELSxA bits.

**Table 11-3. Mode, Edge, and Level Selection**

MSxB	MSxA	ELSxB	ELSxA	Mode	Configuration
X	0	0	0	Output Preset	Pin is CLAMP of sync processor <sup>(1)</sup> ; Initial Output Level High
X	1	0	0		Pin is CLAMP of sync processor <sup>(1)</sup> ; Initial Output Level Low
0	0	0	1	Input Capture	Capture on Rising Edge Only
0	0	1	0		Capture on Falling Edge Only
0	0	1	1		Capture on Rising or Falling Edge
0	1	0	1	Output Compare or PWM	Toggle Output on Compare
0	1	1	0		Clear Output on Compare
0	1	1	1		Set Output on Compare
1	X	0	1	Buffered Output Compare or Buffered PWM	Toggle Output on Compare
1	X	1	0		Clear Output on Compare
1	X	1	1		Set Output on Compare

**Notes:**

1. For CLAMP/TCH0 pin only.

**NOTE:** Before enabling a TIM channel register for input capture operation, make sure that the TCHx pin is stable for at least two bus clocks.

## TOVx — Toggle-On-Overflow Bit

When channel x is an output compare channel, this read/write bit controls the behavior of the channel x output when the TIM counter overflows. When channel x is an input capture channel, TOVx has no effect. Reset clears the TOVx bit.

1 = Channel x pin toggles on TIM counter overflow.

0 = Channel x pin does not toggle on TIM counter overflow.

**NOTE:** When TOVx is set, a TIM counter overflow takes precedence over a channel x output compare if both occur at the same time.

## CHxMAX — Channel x Maximum Duty Cycle Bit

When the TOVx bit is at logic one, setting the CHxMAX bit forces the duty cycle of buffered and unbuffered PWM signals to 100%. As [Figure 11-7](#) shows, the CHxMAX bit takes effect in the cycle after it is set or cleared. The output stays at the 100% duty cycle level until the cycle after CHxMAX is cleared.

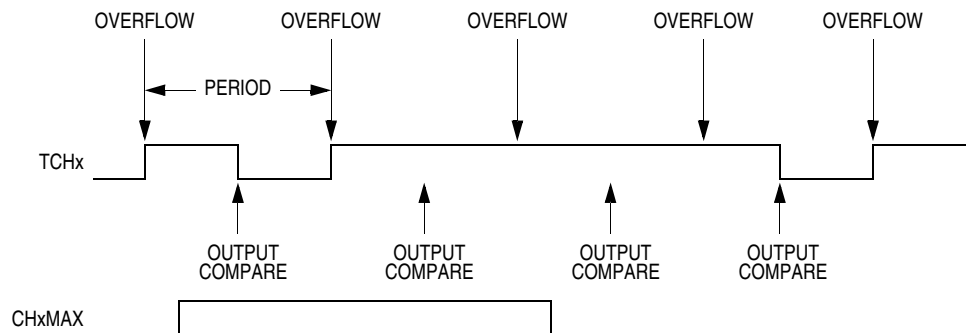

**Figure 11-7. CHxMAX Latency**

### 11.10.5 TIM Channel Registers (TCH0H/L:TCH1H/L)

These read/write registers contain the captured TIM counter value of the input capture function or the output compare value of the output compare function. The state of the TIM channel registers after reset is unknown.

In input capture mode (MSxB:MSxA = 0:0), reading the high byte of the TIM channel x registers (TCHxH) inhibits input captures until the low byte (TCHxL) is read.



In output compare mode ( $MSxB:MSxA \neq 0:0$ ), writing to the high byte of the TIM channel x registers (TCHxH) inhibits output compares until the low byte (TCHxL) is written.

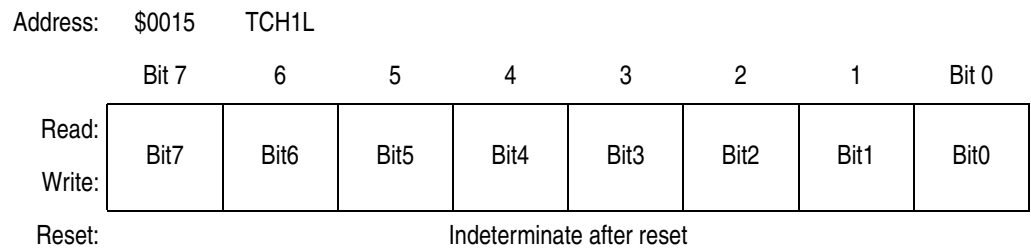
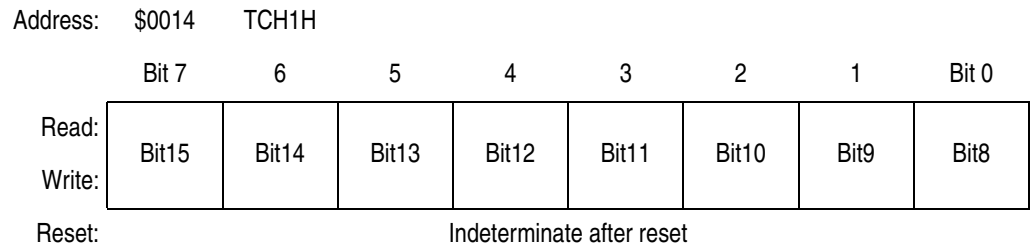
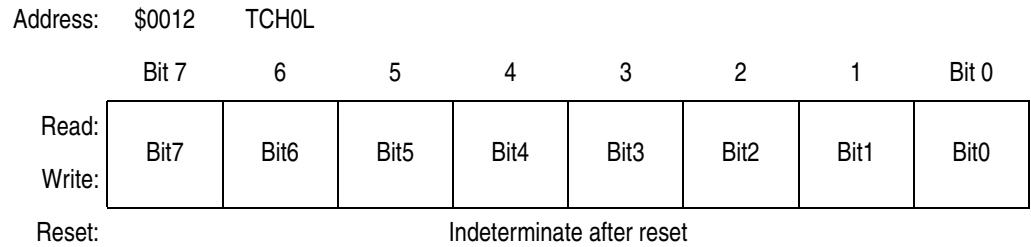
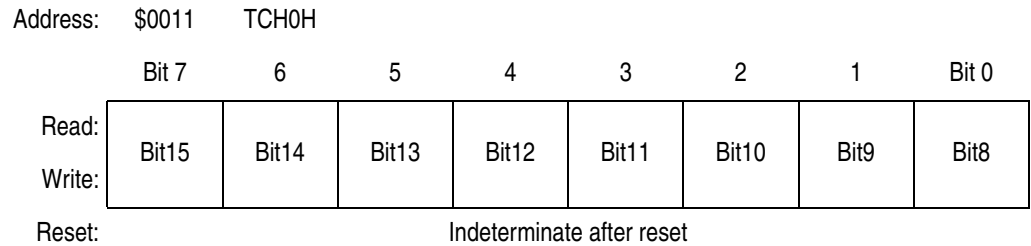

**Figure 11-8. TIM Channel Registers (TCH0H/L:TCH1H/L)**



## Section 12. Pulse Width Modulator (PWM)

### 12.1 Contents

12.2	Introduction . . . . .	171
12.3	Functional Description . . . . .	171
12.4	PWM Registers . . . . .	173
12.4.1	PWM Data Registers 0 to 7 (0PWM–7PWM) . . . . .	173
12.4.2	PWM Control Register (PWMCR) . . . . .	174

### 12.2 Introduction

Eight 8-bit PWM channels are available on the MC68HC908LD64. Channels 0 to 7 are shared with port-B I/O pins under the control of the PWM control register.

### 12.3 Functional Description

Each 8-Bit PWM channel is composed of an 8-bit register which contains a 5-bit PWM in MSB portion and a 3-bit binary rate multiplier (BRM) in LSB portion. There are eight PWM data registers, controlling each PWM channel. The value programmed in the 5-bit PWM portion will determine the pulse length of the output. The clock to the 5-bit PWM portion is the system bus clock, the repetition rate of the output is hence 187.5kHz at 6MHz clock.

The 3-bit BRM will generate a number of narrow pulses which are equally distributed among an 8-PWM-cycle frame. The number of pulses generated is equal to the number programmed in the 3-bit BRM portion. Example of the waveforms are shown in [Figure 12-4](#).

# Pulse Width Modulator (PWM)

Combining the 5-bit PWM together with the 3-bit BRM, the average duty cycle at the output will be  $(M+N/8)/32$ , where M is the content of the 5-bit PWM portion, and N is the content of the 3-bit BRM portion. Using this mechanism, a true 8-bit resolution PWM type DAC with reasonably high repetition rate can be obtained.

The value of each PWM data register is continuously compared with the content of an internal counter to determine the state of each PWM channel output pin. Double buffering is not used in this PWM design.

Addr.	Register Name		Bit 7	6	5	4	3	2	1	Bit 0
\$0070	PWM0 Data Register (0PWM)	Read:	0PWM4	0PWM3	0PWM2	0PWM1	0PWM0	0BRM2	0BRM1	0BRM0
		Write:								
\$0071	PWM1 Data Register (1PWM)	Read:	1PWM4	1PWM3	1PWM2	1PWM1	1PWM0	1BRM2	1BRM1	1BRM0
		Write:								
\$0072	PWM2 Data Register (2PWM)	Read:	2PWM4	2PWM3	2PWM2	2PWM1	2PWM0	2BRM2	2BRM1	2BRM0
		Write:								
\$0073	PWM3 Data Register (3PWM)	Read:	3PWM4	3PWM3	3PWM2	3PWM1	3PWM0	3BRM2	3BRM1	3BRM0
		Write:								
\$0074	PWM4 Data Register (4PWM)	Read:	4PWM4	4PWM3	4PWM2	4PWM1	4PWM0	4BRM2	4BRM1	4BRM0
		Write:								
\$0075	PWM5 Data Register (5PWM)	Read:	5PWM4	5PWM3	5PWM2	5PWM1	5PWM0	5BRM2	5BRM1	5BRM0
		Write:								
\$0076	PWM6 Data Register (6PWM)	Read:	6PWM4	6PWM3	6PWM2	6PWM1	6PWM0	6BRM2	6BRM1	6BRM0
		Write:								
\$0077	PWM7 Data Register (7PWM)	Read:	7PWM4	7PWM3	7PWM2	7PWM1	7PWM0	7BRM2	7BRM1	7BRM0
		Write:								
\$0078	PWM Control Register (PWMCR)	Read:	PWM7E	PWM6E	PWM5E	PWM4E	PWM3E	PWM2E	PWM1E	PWM0E
		Write:								
Reset:			0	0	0	0	0	0	0	0

**Figure 12-1. PWM I/O Register Summary**

## 12.4 PWM Registers

The PWM module uses of nine registers for data and control functions.

- PWM data registers (\$0070–\$0077)
- PWM control register (\$0078)

### 12.4.1 PWM Data Registers 0 to 7 (0PWM–7PWM)

Address: \$0070–\$0077

	Bit 7	6	5	4	3	2	1	Bit 0
Read:	xPWM4	xPWM3	xPWM2	xPWM1	xPWM0	xBRM2	xBRM1	xBRM0
Write:								
Reset:	0	0	0	0	0	0	0	0

**Figure 12-2. PWM Data Registers 0 to 7 (0PWM–7PWM)**

The output waveform of the eight PWM channels are each configured by an 8-bit register, which contains a 5-bit PWM in MSB portion and a 3-bit binary rate multiplier (BRM) in LSB portion

#### xPWM4–xPWM0 — PWM Bits

The value programmed in the 5-bit PWM portion will determine the pulse length of the output. The clock to the 5-bit PWM portion is the system bus clock, the repetition rate of the output is hence  $f_{OP} \div 32$ . Examples of PWM output waveforms are shown in [Figure 12-4](#).

#### xBRM2–xBRM0 — Binary Rate Multiplier Bits

The 3-bit BRM will generate a number of narrow pulses which are equally distributed among an 8-PWM-cycle frame. The number of pulses generated is equal to the number programmed in the 3-bit BRM portion. Examples of PWM output waveforms are shown in [Figure 12-4](#).

## 12.4.2 PWM Control Register (PWMCR)

Address: \$0078

	Bit 7	6	5	4	3	2	1	Bit 0
Read:	PWM7E	PWM6E	PWM5E	PWM4E	PWM3E	PWM2E	PWM1E	PWM0E
Write:								
Reset:	0	0	0	0	0	0	0	0

**Figure 12-3. PWM Control Register (PWMCR)**

### PWM7E–PWM0E — PWM Output Enable

Setting a bit to 1 will enable the corresponding PWM channel to use as PWM output. A zero configures the corresponding PWM pin as a standard I/O port pin. Reset clears these bits.

1 = Port pin configured as PWM output

0 = Port pin configured as standard I/O port pin.

**Table 12-1. PWM Channels and Port I/O pins**

Port Pin	PWM Channel	Control Bit
PTB0	PWM0	PWM0E
PTB1	PWM1	PWM1E
PTB2	PWM2	PWM2E
PTB3	PWM3	PWM3E
PTB4	PWM4	PWM4E
PTB5	PWM5	PWM5E
PTB6	PWM6	PWM6E
PTB7	PWM7	PWM7E

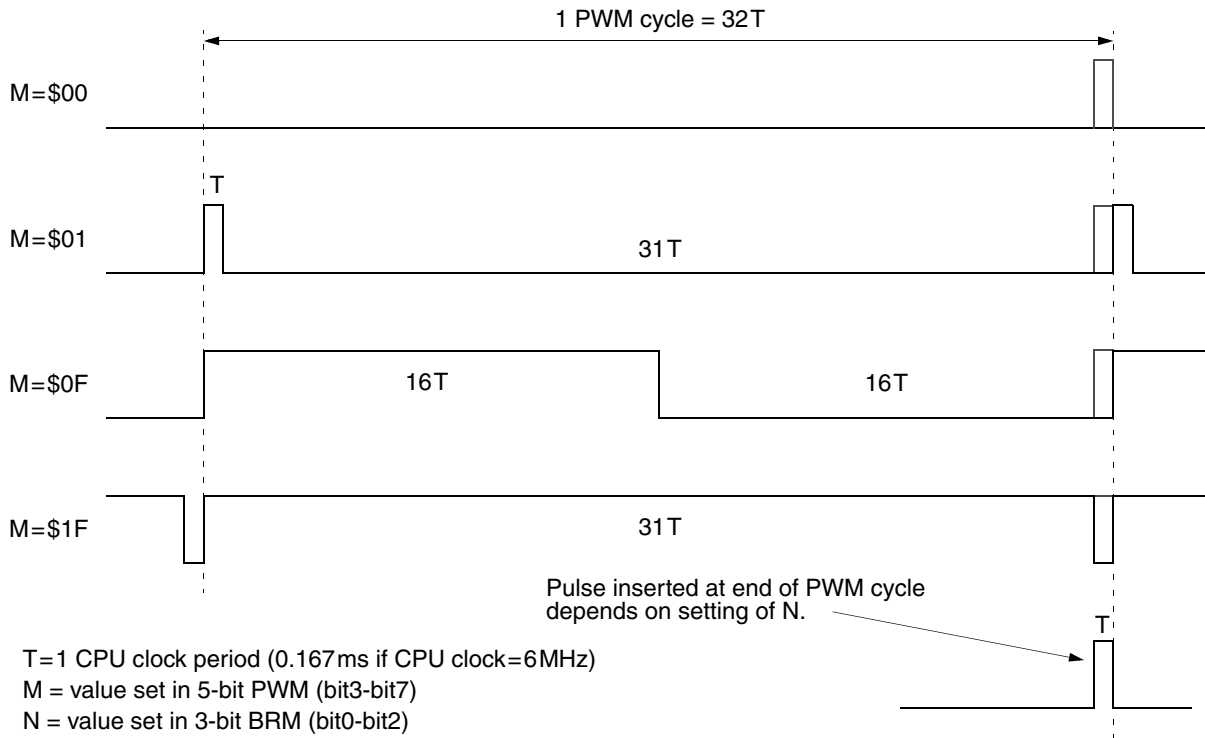

N	PWM cycles where pulses are inserted in a 8-cycle frame	Number of inserted pulses in a 8-cycle frame
xx1	4	1
x1x	2, 6	2
1xx	1, 3, 5, 7	4

Figure 12-4. 8-Bit PWM Output Waveforms





## Section 13. Analog-to-Digital Converter (ADC)

### 13.1 Contents

13.2	Introduction	178
13.3	Features	178
13.4	Functional Description	179
13.4.1	ADC Port I/O Pins	180
13.4.2	Voltage Conversion	180
13.4.3	Conversion Time	180
13.4.4	Continuous Conversion	181
13.4.5	Accuracy and Precision	181
13.5	Interrupts	181
13.6	Low-Power Modes	181
13.6.1	Wait Mode	181
13.6.2	Stop Mode	182
13.7	I/O Signals	182
13.7.1	ADC Analog Power Pin (VDDA)	182
13.7.2	ADC Analog Ground Pin (VSSA)	182
13.7.3	ADC Voltage Reference High Pin (VRH)	182
13.7.4	ADC Voltage Reference Low Pin (VRL)	182
13.7.5	ADC Voltage In (ADCVIN)	182
13.8	I/O Registers	183
13.8.1	ADC Status and Control Register	183
13.8.2	ADC Data Register	185
13.8.3	ADC Input Clock Register	185

## 13.2 Introduction

This section describes the analog-to-digital converter (ADC). The ADC is a 6-channel 8-bit successive approximation ADC.

## 13.3 Features

Features of the ADC module include:

- Six channels with multiplexed input
- Linear successive approximation
- 8-bit resolution
- Single or continuous conversion
- Conversion complete flag or conversion complete interrupt

Addr.	Register Name	Bit 7	6	5	4	3	2	1	Bit 0	
\$003B	ADC Status and Control Register (ADSCR)	Read:	COCO	AIEN	ADCO	ADCH4	ADCH3	ADCH2	ADCH1	ADCH0
		Write:								
		Reset:	0	0	0	1	1	1	1	1
\$003C	ADC Data Register (ADR)	Read:	AD7	AD6	AD5	AD4	AD3	AD2	AD1	AD0
		Write:								
		Reset:	Indeterminate after reset							
\$003D	ADC Input Clock Register (ADICLK)	Read:	ADIV2	ADIV1	ADIV0	0	0	0	0	0
		Write:								
		Reset:	0	0	0	0	0	0	0	0

 = Unimplemented

**Figure 13-1. ADC I/O Register Summary**

## 13.4 Functional Description

Six ADC channels are available for sampling external sources at pins PTC5–PTC0. An analog multiplexer allows the single ADC converter to select one of the six ADC channels as ADC voltage input (ADCVIN). ADCVIN is converted by the successive approximation register-based counters. The ADC resolution is eight bits. When the conversion is completed, ADC puts the result in the ADC data register and sets a flag or generates an interrupt. **Figure 13-2** shows a block diagram of the ADC.

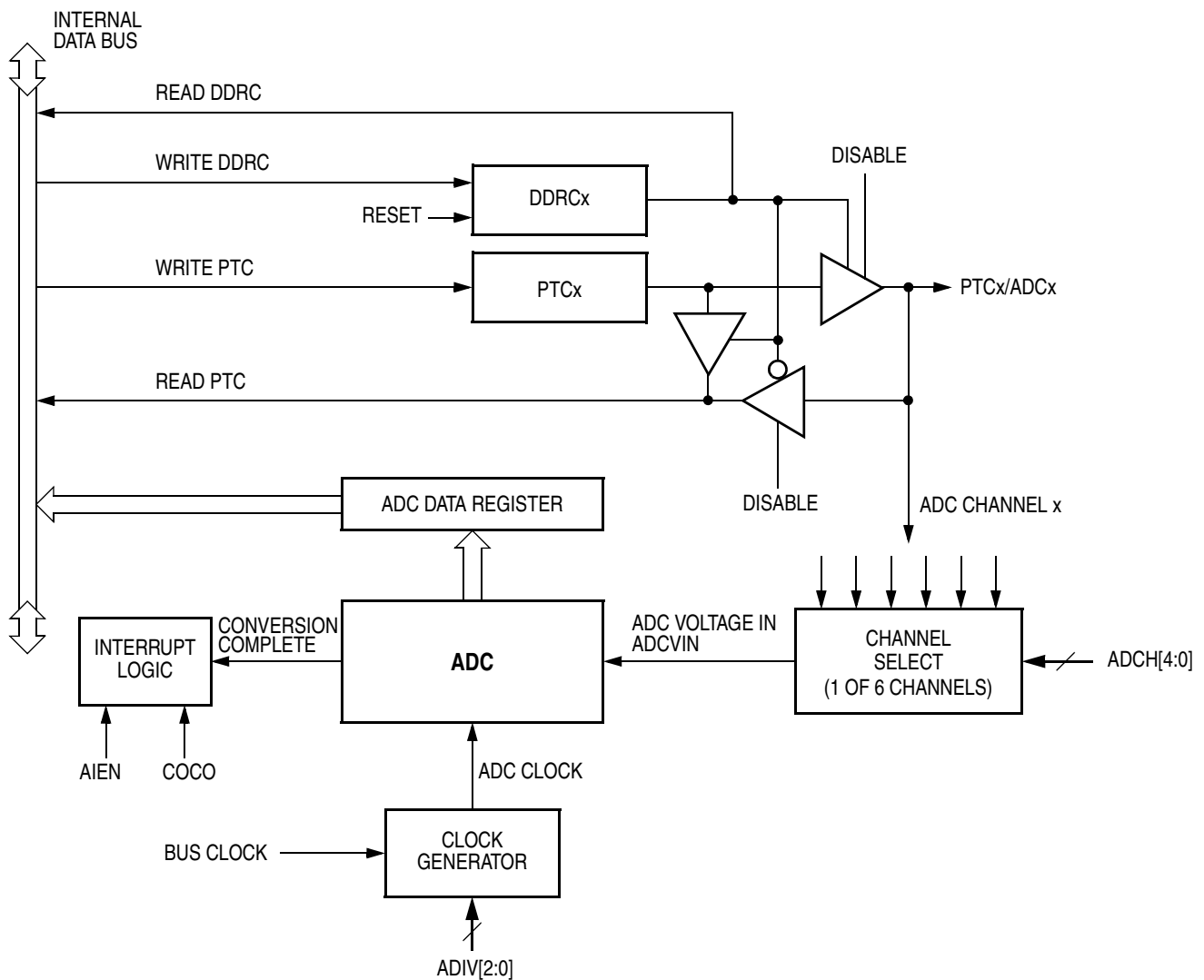

**Figure 13-2. ADC Block Diagram**

## 13.4.1 ADC Port I/O Pins

PTC5/ADC5–PTC0/ADC0 are general-purpose I/O pins that are shared with the ADC channels. The channel select bits, ADCH[4:0], in the ADC status and control register define which ADC channel/port pin will be used as the input signal. The ADC overrides the port I/O logic by forcing that pin as input to the ADC. The remaining ADC channels/port pins are controlled by the port I/O logic and can be used as general-purpose I/O. Writes to the port register or DDR will not have any effect on the port pin that is selected by the ADC. Read of a port pin which is in use by the ADC will return a logic 0 if the corresponding DDR bit is at logic 0. If the DDR bit is at logic 1, the value in the port data latch is read.

## 13.4.2 Voltage Conversion

When the input voltage to the ADC equals to VRH, the ADC converts the signal to \$FF (full scale). If the input voltage equals to VRL, the ADC converts it to \$00. Input voltages between VRH and VRL is a straight-line linear conversion. All other input voltages will result in \$FF if greater than VRH and \$00 if less than VRL.

**NOTE:** *Input voltage should not exceed the analog supply voltages.*

## 13.4.3 Conversion Time

Sixteen ADC internal clocks are required to perform one conversion. The ADC starts a conversion on the first rising edge of the ADC internal clock immediately following a write to the ADSCR. If the ADC internal clock is selected to run at 1 MHz, then one conversion will take 16 $\mu$ s to complete. With a 1 MHz ADC internal clock the maximum sample rate is 62.5 kHz.

$$\text{Conversion time} = \frac{16 \text{ to } 17 \text{ ADC cycles}}{\text{ADC frequency}}$$

$$\text{Number of bus cycles} = \text{conversion time} \times \text{bus frequency}$$

### 13.4.4 Continuous Conversion

In the continuous conversion mode, the ADC continuously converts the selected channel filling the ADC data register with new data after each conversion. Data from the previous conversion will be overwritten whether that data has been read or not. Conversions will continue until the ADCO bit is cleared. The conversion complete bit, COCO, in the ADC status and control register is set after each conversion and can be cleared by writing to the ADC status and control register or reading of the ADC data register.

### 13.4.5 Accuracy and Precision

The conversion process is monotonic and has no missing codes.

## 13.5 Interrupts

When the AIEN bit is set, the ADC module is capable of generating a CPU interrupt after each ADC conversion. A CPU interrupt is generated if the COCO bit is at logic 0. The COCO bit is not used as a conversion complete flag when interrupts are enabled. The interrupt vector is defined in [Table 2-1 . Vector Addresses](#).

## 13.6 Low-Power Modes

The WAIT and STOP instruction can put the MCU in low-power consumption standby modes.

### 13.6.1 Wait Mode

The ADC continues normal operation during wait mode. Any enabled CPU interrupt request from the ADC can bring the MCU out of wait mode. If the ADC is not required to bring the MCU out of wait mode, power down the ADC by setting the ADCH[4:0] bits in the ADC status and control register to logic 1's before executing the WAIT instruction.

### 13.6.2 Stop Mode

The ADC module is inactive after the execution of a STOP instruction. Any pending conversion is aborted. ADC conversions resume when the MCU exits stop mode. Allow one conversion cycle to stabilize the analog circuitry before attempting a new ADC conversion after exiting stop mode.

## 13.7 I/O Signals

The ADC module has six channels that are shared with port C I/O pins, PTC5/ADC5–PTC0/ADC0.

### 13.7.1 ADC Analog Power Pin (VDDA)

The ADC analog portion uses VDDA as its power pin. Connect the VDDA pin to the same voltage potential as VDD. External filtering may be necessary to ensure clean VDDA for good results.

**NOTE:** *Route VDDA carefully for maximum noise immunity and place bypass capacitors as close as possible to the package.*

### 13.7.2 ADC Analog Ground Pin (VSSA)

The ADC analog portion uses VSSA as its ground pin. Connect the VSSA pin to the same voltage potential as VSS.

### 13.7.3 ADC Voltage Reference High Pin (VRH)

VRH is the high voltage reference for the ADC.

### 13.7.4 ADC Voltage Reference Low Pin (VRL)

VRL is the low voltage reference for the ADC.

### 13.7.5 ADC Voltage In (ADCVIN)

ADCVIN is the input voltage signal from one of the six ADC channels to the ADC module.

## 13.8 I/O Registers

Three I/O registers control and monitor ADC operation:

- ADC status and control register (ADSCR)
- ADC data register (ADR)
- ADC input clock register (ADICLK)

### 13.8.1 ADC Status and Control Register

Function of the ADC status and control register is described here.

Address: \$003B

	Bit 7	6	5	4	3	2	1	Bit 0
Read:	COCO	AIEN	ADCO	ADCH4	ADCH3	ADCH2	ADCH1	ADCH0
Write:								
Reset:	0	0	0	1	1	1	1	1

= Unimplemented

**Figure 13-3. ADC Status and Control Register (ADSCR)**

#### COCO — Conversions Complete Bit

When the AIEN bit is a logic 0, the COCO is a read-only bit which is set each time a conversion is completed. This bit is cleared whenever the ADC status and control register is written, or whenever the ADC data register is read. Reset clears this bit.

When the AIEN bit is a logic 1 (CPU interrupt enabled), the COCO is a read-only bit, and will always be logic 0 when read.

1 = conversion completed (AIEN = 0)

0 = conversion not completed (AIEN = 0)

#### AIEN — ADC Interrupt Enable Bit

When this bit is set, an interrupt is generated at the end of an ADC conversion. The interrupt signal is cleared when the data register is read or the status and control register is written. Reset clears the AIEN bit.

1 = ADC interrupt enabled

0 = ADC interrupt disabled

## Analog-to-Digital Converter (ADC)

### ADCO — ADC Continuous Conversion Bit

When set, the ADC will convert samples continuously and update the ADR register at the end of each conversion. Only one conversion is allowed when this bit is cleared. Reset clears the ADCO bit.

1 = Continuous ADC conversion

0 = One ADC conversion

### ADCH[4:0] — ADC Channel Select Bits

ADCH[4:0] form a 5-bit field which is used to select one of the ADC channels or reference voltages. The five channel select bits are detailed in the [Table 13-1](#).

**NOTE:** Care should be taken when using a port pin as both an analog and a digital input simultaneously to prevent switching noise from corrupting the analog signal.

**NOTE:** Recovery from the disabled state requires one conversion cycle to stabilize.

**Table 13-1. MUX Channel Select**

ADCH4	ADCH3	ADCH2	ADCH1	ADCH0	ADC Channel	Input Select
0	0	0	0	0	ADC0	PTC0/ADC0
0	0	0	0	1	ADC1	PTC1/ADC1
0	0	0	1	0	ADC2	PTC2/ADC2
0	0	0	1	1	ADC3	PTC3/ADC3
0	0	1	0	0	ADC4	PTC4/ADC4
0	0	1	0	1	ADC5	PTC5/ADC5
0	0	1	1	0	—	Unused <sup>(1)</sup>
↓	↓	↓	↓	↓	—	
1	1	0	1	0	—	Reserved
1	1	1	0	0	—	Unused
1	1	1	0	1		VRH
1	1	1	1	0		VRL
1	1	1	1	1		ADC power off

**Notes:**

1. If any unused channels are selected, the resulting ADC conversion will be unknown.



### 13.8.2 ADC Data Register

One 8-bit result register, ADC data register (ADR), is provided. This register is updated each time an ADC conversion completes.

Address: \$003C

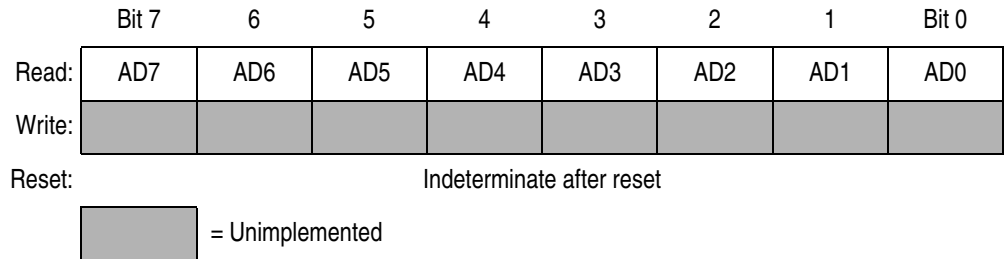
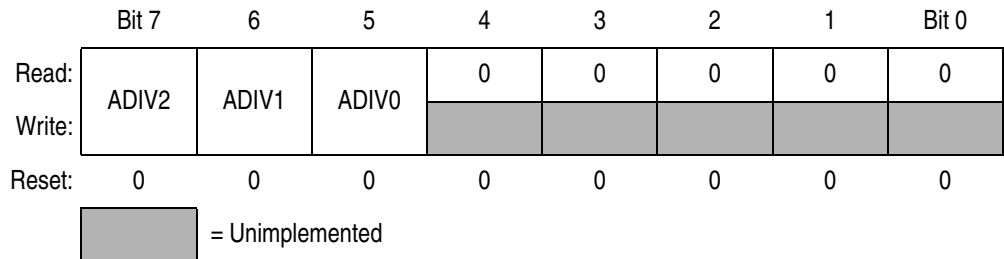

**Figure 13-4. ADC Data Register (ADR)**

### 13.8.3 ADC Input Clock Register

The ADC input clock register (ADICLK) selects the clock frequency for the ADC.

Address: \$003D



**Figure 13-5. ADC Input Clock Register (ADICLK)**

#### ADIV[2:0] — ADC Clock Prescaler Bits

ADIV[2:0] form a 3-bit field which selects the divide ratio used by the ADC to generate the internal ADC clock. [Table 13-2](#) shows the available clock configurations. The ADC clock should be set to approximately 1 MHz.

**Table 13-2. ADC Clock Divide Ratio**

<b>ADIV2</b>	<b>ADIV1</b>	<b>ADIV0</b>	<b>ADC Clock Rate</b>
0	0	0	ADC Input Clock ÷ 1
0	0	1	ADC Input Clock ÷ 2
0	1	0	ADC Input Clock ÷ 4
0	1	1	ADC Input Clock ÷ 8
1	X	X	ADC Input Clock ÷ 16

X = don't care

## Section 14. Universal Serial Bus Module (USB)

### 14.1 Contents

14.2	Introduction	188
14.3	Features	188
14.4	I/O Pins	189
14.5	Overview	192
14.6	Hub Function I/O Registers	194
14.6.1	USB Hub Root Port Control Register (HRPCR)	194
14.6.2	USB Hub Downstream Port Control Registers (HDP1CR–HDP4CR)	195
14.6.3	USB SIE Timing Interrupt Register (SIETIR)	198
14.6.4	USB SIE Timing Status Register (SIETSR)	200
14.6.5	USB Hub Address Register (HADDR)	202
14.6.6	USB Hub Interrupt Register 0 (HIR0)	203
14.6.7	USB Hub Control Register 0 (HCR0)	205
14.6.8	USB Hub Endpoint 1 Control and Data Register (HCDR)	206
14.6.9	USB Hub Status Register (HSR)	208
14.6.10	USB Hub Endpoint 0 Data Registers (HE0D0–HE0D7)	209
14.7	Embedded Device Function I/O Registers	209
14.7.1	USB Embedded Device Address Register (DADDR)	210
14.7.2	USB Embedded Device Interrupt Register 0 (DIR0)	210
14.7.3	USB Embedded Device Interrupt Register 1 (DIR1)	212
14.7.4	USB Embedded Device Control Register 0 (DCR0)	213
14.7.5	USB Embedded Device Control Register 1 (DCR1)	215
14.7.6	USB Embedded Device Control Register 2 (DCR2)	216
14.7.7	USB Embedded Device Status Register (DSR)	217
14.7.8	USB Embedded Device Endpoint 0 Data Registers (DE0D0–DE0D7)	219
14.7.9	USB Embedded Device Endpoint 1/2 Data Registers (DE1D0–DE1D7)	219

## 14.2 Introduction

This section describes the Universal Serial Bus (USB) module. This MC68HC908LD64's USB module supports both embedded full-speed device and hub functions with one upstream port and four downstream ports.

## 14.3 Features

Features of the USB module include the following:

- Integrated USB transceiver supporting both full-speed and low-speed functions
- USB data control logic
  - Packet decoding/generation
  - CRC generation and checking
  - NRZI encoding/decoding
  - Bit-stuffing
- USB reset support
- Suspend and resume operations
- Remote wakeup support
- STALL, NAK, and ACK handshake generation

Features of the hub function include the following:

- Hub control endpoint 0
  - 8-byte transmit buffer
  - 8-byte receive buffer
- Hub interrupt endpoint 1
  - 1-byte transmit buffer
- USB interrupts
  - Transaction interrupt driven
  - Start of frame interrupt

- EOF2 interrupt
- End of packet interrupt
- Signal transition interrupt
- Frame timer locked interrupt
- Hub repeater and controller function
  - Downstream and upstream connectivity
  - Bus state evaluation
  - Selective reset, suspend and resume
  - Fault condition hardware detection

Features of the embedded device function include the following:

- Device control endpoint 0
  - 8-byte transmit buffer
  - 8-byte receive buffer
- Device interrupt endpoints 1 and 2
  - 8-byte transmit buffer
- USB generated interrupts
  - transaction interrupt driven

## 14.4 I/O Pins

The USB module uses ten I/O pin (five pairs), with two dedicated pins for the upstream port pair and eight shared port I/O pins for the downstream ports. The full name of the USB I/O pins are listed in [Table 14-1](#). The generic pin name appear in the text that follows.

**Table 14-1. USB I/O Pins**

USB Generic Pin Names:	Full MCU Pin Names:	Pin Selected for USB Function By:
D0+	DPLUS0	—
D0-	DMINUS0	
D1+	PTE0/DPLUS1	USBDS1E bit in PECR (\$0068)
D1-	PTE1/DMINUS1	
D2+	PTE2/DPLUS2	USBDS2E bit in PECR (\$0068)
D2-	PTE3/DMINUS2	
D3+	PTE4/DPLUS3	USBDS3E bit in PECR (\$0068)
D3-	PTE5/DMINUS3	
D4+	PTE6/DPLUS4	USBDS4E bit in PECR (\$0068)
D4-	PTE7/DMINUS4	

Addr.	Register Name		Bit 7	6	5	4	3	2	1	Bit 0
\$0020 to \$0027	USB Embedded Device Endpoint 0 Data Register 0 to 7 (DE0D0 to DE0D7)	Read:	DE0Rx7	DE0Rx6	DE0Rx5	DE0Rx4	DE0Rx3	DE0Rx2	DE0Rx1	DE0Rx0
		Write:	DE0Tx7	DE0Tx6	DE0Tx5	DE0Tx4	DE0Tx3	DE0Tx2	DE0Tx1	DE0Tx0
		Reset:	Indeterminate after reset							
\$0028 to \$002F	USB Embedded Device Endpoint 1/2 Data Register 0 to 7 (DE1D0 to DE1D7)	Read:								
		Write:	DE1Tx7	DE1Tx6	DE1Tx5	DE1Tx4	DE1Tx3	DE1Tx2	DE1Tx1	DE1Tx0
		Reset:	Indeterminate after reset							
\$0030 to \$0037	USB Hub Endpoint 0 Data Register 0 to 7 (HE0D0 to HE0D7)	Read:	HE0Rx7	HE0Rx6	HE0Rx5	HE0Rx4	HE0Rx3	HE0Rx2	HE0Rx1	HE0Rx0
		Write:	HE0Tx7	HE0Tx6	HE0Tx5	HE0Tx4	HE0Tx3	HE0Tx2	HE0Tx1	HE0Tx0
		Reset:	Indeterminate after reset							
\$0047	USB Embedded Device Control Register 2 (DCR2)	Read:	0	0	0	0	ENABLE2	ENABLE1	DSTALL2	DSTALL1
		Write:								
		Reset:	0	0	0	0	0	0	0	0
\$0048	USB Embedded Device Address Register (DADDR)	Read:	DEVEN	DADD6	DADD5	DADD4	DADD3	DADD2	DADD1	DADD0
		Write:								
		Reset:	0	0	0	0	0	0	0	0

X = Indeterminate       = Unimplemented

**Figure 14-1. USB I/O Register Summary**

\$0049	USB Embedded Device Interrupt Register 0 (DIR0)	Read:	TXD0F	RXD0F	0	0	TXD0IE	RXD0IE	0	0
		Write:							TXD0FR	RXD0FR
		Reset:	0	0	0	0	0	0	0	0
\$004A	USB Embedded Device Interrupt Register 1 (DIR1)	Read:	TXD1F	0	0	0	TXD1IE	0	0	0
		Write:							TXD1FR	
		Reset:	0	0	0	0	0	0	0	0
\$004B	USB Embedded Device Control Register 0 (DCR0)	Read:	T0SEQ	DSTALL0	TX0E	RX0E	TP0SIZ3	TP0SIZ2	TP0SIZ1	TP0SIZ0
		Write:								
		Reset:	0	0	0	0	0	0	0	0
\$004C	USB Embedded Device Control Register 1 (DCR1)	Read:	T1SEQ	ENDADD	TX1E	0	TP1SIZ3	TP1SIZ2	TP1SIZ1	TP1SIZ0
		Write:								
		Reset:	0	0	0	0	0	0	0	0
\$004D	USB Embedded Device Status Register (DSR)	Read:	DRSEQ	DSETUP	DTX1ST	0	RP0SIZ3	RP0SIZ2	RP0SIZ1	RP0SIZ0
		Write:				DTX1STR				
		Reset:	0	0	0	0	0	0	0	0
\$0051	USB Hub Downstream Port 1 Control Register (HDP1CR)	Read:	PEN1	LOWSP1	RST1	RESUM1	SUSP1	0	D1+	D1-
		Write:								
		Reset:	0	0	0	0	0	0	X	X
\$0052	USB Hub Downstream Port 2 Control Register (HDP2CR)	Read:	PEN2	LOWSP2	RST2	RESUM2	SUSP2	0	D2+	D2-
		Write:								
		Reset:	0	0	0	0	0	0	X	X
\$0053	USB Hub Downstream Port 3 Control Register (HDP3CR)	Read:	PEN3	LOWSP3	RST3	RESUM3	SUSP3	0	D3+	D3-
		Write:								
		Reset:	0	0	0	0	0	0	X	X
\$0054	USB Hub Downstream Port 4 Control Register (HDP4CR)	Read:	PEN4	LOWSP4	RST4	RESUM4	SUSP4	0	D4+	D4-
		Write:								
		Reset:	0	0	0	0	0	0	X	X
\$0056	USB SIE Timing Interrupt Register (SIETIR)	Read:	SOFF	EOF2F	EOPF	TRANF	SOFIE	EOF2IE	EOPIE	TRANIE
		Write:								
		Reset:	0	0	0	0	0	0	0	0
\$0057	USB SIE Timing Status Register (SIETSR)	Read:	RSTF	0	LOCKF	0	0	0	0	0
		Write:		RSTFR		LOCKFR	SOFFR	EOF2FR	EOPFR	TRANFR
		Reset:	0*	0	0	0	0	0	0	0

X = Indeterminate       = Unimplemented

**Figure 14-1. USB I/O Register Summary**

# Universal Serial Bus Module (USB)

\$0058	USB Hub Address Register (HADDR)	Read:	USBEN	ADD6	ADD5	ADD4	ADD3	ADD2	ADD1	ADD0
		Write:								
		Reset:	0*	0	0	0	0	0	0	0
* RSTF and USBEN are reset by a power-on reset (POR) only.										
\$0059	USB Hub Interrupt Register 0 (HIR0)	Read:	TXDF	RXDF	0	0	TXDIE	RXDIE	0	0
		Write:							TXDFR	RXDFR
		Reset:	0	0	0	0	0	0	0	0
\$005B	USB Hub Control Register 0 (HCR0)	Read:	TSEQ	STALL0	TXE	RXE	TPSIZ3	TPSIZ2	TPSIZ1	TPSIZ0
		Write:								
		Reset:	0	0	0	0	0	0	0	0
\$005C	USB Hub Endpoint 1 Control and Data Register (HCDR)	Read:	STALL1	PNEW	PCHG5	PCHG4	PCHG3	PCHG2	PCHG1	PCHG0
		Write:								
		Reset:	0	0	0	0	0	0	0	0
\$005D	USB Hub Status Register (HSR)	Read:	RSEQ	SETUP	TX1ST	0	RPSIZ3	RPSIZ2	RPSIZ1	RPSIZ0
		Write:				TX1STR				
		Reset:	X	X	X	0	X	X	X	X
\$005E	USB Hub Root Port Control Register (HRPCR)	Read:	0	0	0	RESUM0	SUSPND	0	D0+	D0-
		Write:								
		Reset:	0	0	0	0	0	0	X	X

X = Indeterminate       = Unimplemented

**Figure 14-1. USB I/O Register Summary**

## 14.5 Overview

This USB module is designed to serve as a compound device. An embedded full-speed device function is combined with a hub in a single USB module.

For the hub sub-module, five basic properties can be supported by the hardware or the software: connectivity behavior, power management, device connect/disconnect detection, bus fault detection and recovery, and full/low-speed device traffic control. Endpoint 0 of the hub sub-module functions as a receive/transmit control endpoint. Endpoint 1 of the hub sub-module functions as interrupt transfer to report the device change state.



For the embedded device sub-module, three types of USB data transfers are supported: control, interrupt, and bulk (transmit only). Endpoint 0 of the embedded device sub-module functions as a receive/transmit control endpoint. Endpoints 1 and 2 of the embedded device sub-module can function as interrupt or bulk, but only in the transmit direction.

The block diagram of the USB module is shown **Figure 14-2**. The USB module manages communications between the host and the USB function. The module is partitioned into eight functional blocks. These blocks consist of a dual function transceiver, the hub repeater function, the serial interface engine (SIE), the frame counter logic, the hub control logic, the embedded device control logic, and the endpoint registers.

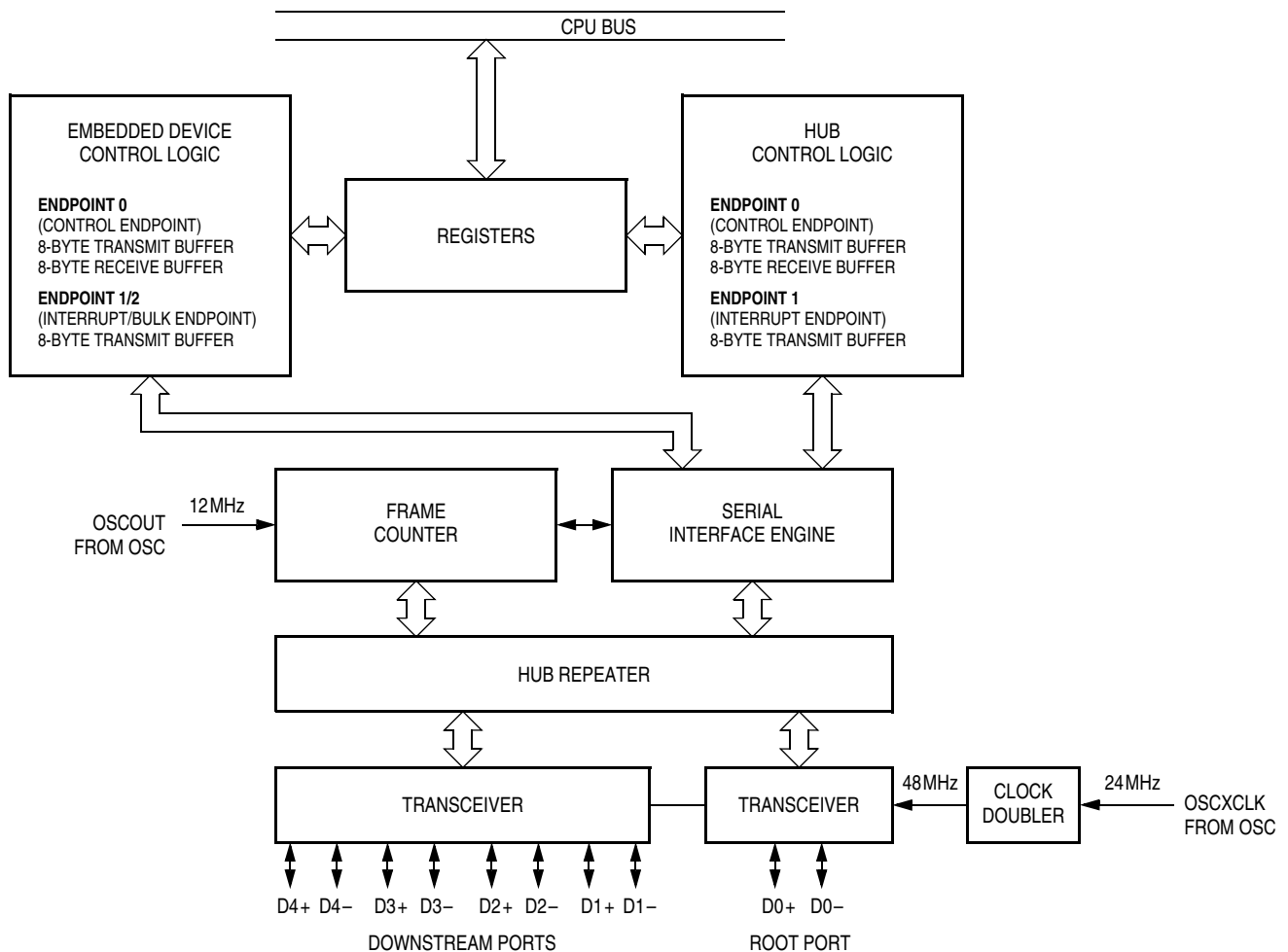

**Figure 14-2. USB Module Block Diagram**

## 14.6 Hub Function I/O Registers

The USB hub function provides a set of control/status registers and sixteen data registers that provide storage for the buffering of data between the USB hub function and the CPU.

### 14.6.1 USB Hub Root Port Control Register (HRPCR)

Address: \$005E

	Bit 7	6	5	4	3	2	1	Bit 0
Read:	0	0	0	RESUM0	SUSPND	0	D0+	D0-
Write:								
Reset:	0	0	0	0	0	0	X	X

X = Indeterminate       = Unimplemented

**Figure 14-3. USB Hub Root Port Control Register (HRPCR)**

#### RESUM0 — Force Resume to the Root Port

This read/write bit forces a resume signal (K state) onto the USB root port data lines to initiate a remote wakeup. Software should control the timing of the forced resume to be between 10ms and 15ms.

Reset clears this bit.

1 = Force root port data lines to K state

0 = Default

#### SUSPND — USB Suspend Control Bit

To save power, this read/write bit should be set by the software if a constant idle state for more than 3ms is detected on the USB bus. Setting this bit puts the transceiver into a power savings mode.

This bit also determines the latch scheme for the data lines of the root port and the downstream port. When this bit is 1, the current state shown on the data lines will be reflected to the data register (D+/D-) directly. When the bit is 0, the data registers are the latched state sampled at the last EOF2 sample point. The hub repeater's function is affected by this bit too. The upstream and downstream traffic will be blocked if this bit is set to 1. When the global resume or the downstream remote wakeup signal is found by the suspended hub,

software is responsible to propagate the traffic between the root port and the enabled downstream port by setting the RESUMx control bit. Reset clears this bit.

EOF2 is generated by the MCU every millisecond, if SOF is not detected when three or more EOF2 have occurred, software can set the SUSPND bit and put the MCU into suspend mode.

#### D0+, D0— — Root Port Differential Data

These read-only bits are the differential data shown on the hub root ports. When the SUSPND bit is 0, the data is the latched state at the last EOF2 sample point. When the SUSPND bit is 1, the data reflects the current state on the data line while accessing this register.

### 14.6.2 USB Hub Downstream Port Control Registers (HDP1CR–HDP4CR)

		Bit 7	6	5	4	3	2	1	Bit 0
Read:		PEN1	LOWSP1	RST1	RESUM1	SUSP1	0	D1+	D1—
Write:									
Read:		PEN2	LOWSP2	RST2	RESUM2	SUSP2	0	D2+	D2—
Write:									
Read:		PEN3	LOWSP3	RST3	RESUM3	SUSP3	0	D3+	D3—
Write:									
Read:		PEN4	LOWSP4	RST4	RESUM4	SUSP4	0	D4+	D4—
Write:									
Reset:		0	0	0	0	0	0	X	X

X = Indeterminate       = Unimplemented

**Figure 14-4. USB Hub Downstream Port Control Registers (HDP1CR–HDP4CR)**

#### PENx — Downstream Port Enable Control Bit

This read/write bit determines whether the enabled or disabled state should be assigned to the downstream port. Setting this bit to 1 enables the port; clearing this bit to 0 disables the port. In the enabled state a full-speed port propagates all downstream signaling;

a low-speed port propagates downstream low-speed packet traffic when preceded by the preamble PID. An enabled port propagates all upstream signaling including full-speed and low-speed packets. This bit can be set to 1 by the host request only. It can be cleared either by hardware when a fault condition was detected or by software through the host request. Reset clears this bit.

- 1 = Downstream port is enabled
- 0 = Downstream port is disabled

### LOWSPx — Full-Speed / Low-Speed Port Control Bit

This read/write bit specifies the attached device in the downstream port is low-speed device or full-speed device. Software is responsible to detect the device attachment and whether a device is full or low-speed. Reset clears this bit.

- 1 = Downstream port is low-speed
- 0 = Downstream port is full-speed

**NOTE:** *After a port is enabled, the hub will automatically generate a low-speed keep awake signal to the port every millisecond.*

### RSTx — Force Reset to the Downstream Port

This read/write bit forces a reset signal (SE0 state) onto the USB downstream port data lines. This bit can be set by the host request SetPortFeature (PORT\_RESET) only. Software should control the timing of the forced reset signaling downstream for at least 10ms. Reset clears this bit.

- 1 = Force downstream port data lines to SE0 state
- 0 = Default

### RESUMx — Force Resume to the Downstream Port

This read/write bit forces a resume signal (K state) onto the USB downstream port data lines. This bit is set to reflect the resume signal when the software detects the remote resume signal on the data lines of the selective suspend downstream port. Downstream selective resume sequence to a port may also be initiated via the host request ClearPortFeature (PORT\_SUSPEND). Software should control the timing of the forced resume signaling downstream for at least 20ms.

To indicate the end of the resume, a low-speed EOP signal will be followed when this control bit changes from 1 to 0. Reset clears this bit.

- 1 = Force downstream port data lines to K state
- 0 = Default

#### SUSPx — Downstream Port Selective Suspend Bit

This read/write bit forces the downstream port entering the selective suspend mode. This bit can be set by the host request SetPortFeature (PORT\_SUSPEND) only. When this bit is set, the hub prevents propagating any bus activity (except the port reset or port resume request or the global reset signal) downstream, and the port can only reflect upstream bus state changes via the endpoint 1 of the hub. The blocking occurs at the next EOF2 point when this bit is set. Reset clears this bit.

- 1 = Force downstream port enters the selective suspend mode
- 0 = Default

#### Dx+, Dx— — Downstream Port Differential Data

These read-only bits are the differential data shown on the hub downstream ports. When the SUSPND bit is 0 in the HRPCR register, the data is the latched state at the last EOF2 sample point. When the SUSPND bit is 1, the data reflects the current state on the data line while accessing this register.

## 14.6.3 USB SIE Timing Interrupt Register (SIETIR)

Address: \$0056

	Bit 7	6	5	4	3	2	1	Bit 0
Read:	SOFF	EOF2F	EOPF	TRANF	SOFIE	EOF2IE	EOPIE	TRANIE
Write:								
Reset:	0	0	0	0	0	0	0	0

= Unimplemented

**Figure 14-5. USB SIE Timing Interrupt Register (SIETIR)**

### SOFF — Start Of Frame Detect Flag

This read-only bit is set when a valid SOF PID is detected on the D0+ and D0– lines at the root port. Software must clear this flag by writing a logic 1 to SOFFR bit in the SIETSR register. Reset clears this bit. Writing to SOFF has no effect.

- 1 = Start Of Frame PID has been detected
- 0 = Start Of Frame PID has not been detected

### EOF2F — Second End Of Frame Point Flag

This read-only bit is set when the internal frame timer counts to the bit time that the hub must see upstream traffic terminated near the end of frame. This bit time is defined as 10 bit times from the next Start Of Frame PID. Software must clear this flag by writing a logic 1 to EOF2FR bit in the SIETSR register. Reset clears this bit. Writing to EOF2F has no effect.

- 1 = Frame timer counts to the EOF2 point
- 0 = Frame timer does not count to the EOF2 point

### EOPF — End of Packet Detect Flag

This read-only bit is set when a valid End Of Packet sequence is detected on the D0+ and D0– lines. Software must clear this flag by writing a logic 1 to the EOPFR bit in the SIETSR register. Reset clears this bit. Writing to EOPF has no effect.

- 1 = End-of-Packet sequence has been detected
- 0 = End-of-Packet sequence has not been detected

#### TRANF — Bus Signal Transition Detect Flag

This read-only bit is set if there is any bus activity on the upstream or the downstream data lines. Generally, this bit is used to wake up the suspended hub when there is any bus activity occurred. Software must clear this flag by writing a logic 1 to the TRANFR bit in the SIETSR register. Reset clears this bit. Writing to TRANF has no effect.

- 1 = Signal transition has been detected
- 0 = Signal transition has not been detected

#### SOFIE — Start Of Frame Interrupt Enable

This read/write bit enables the Start Of Frame to generate a USB interrupt when the SOFF bit becomes set. Reset clears this bit.

- 1 = USB interrupt enabled for Start Of Frame
- 0 = USB interrupt disabled for Start Of Frame

#### EOF2IE — The Second End of Frame Point Interrupt Enable

This read/write bit enables the Second End Of Frame to generate a USB interrupt when the EOF2F bit becomes set. Reset clears this bit.

- 1 = USB interrupt enabled for the Second End Of Frame Point
- 0 = USB interrupt disabled for the Second End Of Frame Point

#### EOPIE — End of Packet Detect Interrupt Enable

This read/write bit enables the End Of Frame to generate a USB interrupt when the EOPF bit becomes set. Reset clears the bit.

- 1 = USB interrupt enabled for End-of-Packet sequence detection
- 0 = USB interrupt disabled for End-of-Packet sequence detection

#### TRANIE — Bus Signal Transition Detect Interrupt Enable

This read/write bit enables the bus signal transition to generate a USB interrupt when the TRANF bit becomes set. Reset clears this bit.

- 1 = USB interrupt enabled for Bus Signal Transition
- 0 = USB interrupt disabled for Bus Signal Transition

## 14.6.4 USB SIE Timing Status Register (SIETSR)

Address: \$0057

	Bit 7	6	5	4	3	2	1	Bit 0
Read:	RSTF	0	LOCKF	0	0	0	0	0
Write:		RSTFR		LOCKFR	SOFFR	EOF2FR	EOPFR	TRANFR
Reset:	0*	0	0	0	0	0	0	0

 = Unimplemented

\* RSTF is reset by a power-on reset (POR) only.

**Figure 14-6. USB SIE Timing Status Register (SIETSR)**

### RSTF — USB Reset Flag

This read-only bit is set when a valid USB reset signal state is detected on the D0+ and D0– lines. This bit is cleared by writing a logic 1 to the RSTFR bit or by a MCU power-on reset.

- 1 = USB reset signal detected on D0+ and D0–
- 0 = No USB reset detected

### RSTFR — Clear Reset Flag Bit

Writing a logic 1 to this write-only bit will clear the RSTF bit if it is set. Reset clears this bit.

- 1 = Write 1 to clear the RSTF bit
- 0 = No effect

### LOCKF — USB Frame Timer Locked

This read-only bit is set when the internal frame timer is locked to the host timer. This bit is cleared by writing a logic 1 to the LOCKFR bit. Reset clears this bit.

- 1 = Internal frame timer is locked to the host timer
- 0 = Internal frame timer is not locked to the host timer

### LOCKFR — Clear Frame Timer Locked Flag

Writing a logic 1 to this write-only bit will clear the LOCKF bit if it is set. Reset clears this bit.

- 1 = Write 1 to clear the LOCKF bit
- 0 = No effect



#### SOFFR — Start Of Frame Flag Reset

Writing a logic 1 to this write-only bit will clear the SOFF bit if it is set.

Reset clears this bit.

1 = Write 1 to clear the SOFF bit

0 = No effect

#### EOF2FR — The Second End of Frame Point Flag Reset

Writing a logic 1 to this write-only bit will clear the EOF2F bit if it is set.

Reset clears this bit.

1 = Write 1 to clear the EOF2F bit

0 = No effect

#### EOPFR — End of Packet Flag Reset

Writing a logic 1 to this write-only bit will clear the EOPF bit if it is set.

Reset clears this bit.

1 = Write 1 to clear the EOPF bit

0 = No effect

#### TRANFR — Bus Signal Transition Flag Reset

Writing a logic 1 to this write-only bit will clear the TRANF bit if it is set.

Reset clears this bit.

1 = Write 1 to clear TRANF bit

0 = No effect

## 14.6.5 USB Hub Address Register (HADDR)

Address: \$0058

	Bit 7	6	5	4	3	2	1	Bit 0
Read:								
Write:	USBEN	ADD6	ADD5	ADD4	ADD3	ADD2	ADD1	ADD0
Reset:	0*	0	0	0	0	0	0	0

\* USBEN is reset by a power-on reset (POR) only.

**Figure 14-7. USB Hub Address Register (HADDR)**

### USBEN — USB Module Enable

This read/write bit enables and disables the USB module. When USBEN is cleared, the USB module will not respond to any tokens. Power-on reset clears this bit.

1 = USB module enabled

0 = USB module disabled; USB transceiver is also disabled to save power.

### ADD[6:0] — USB Hub Function Address

These bits specify the address of the hub function. Reset clears these bits.

### 14.6.6 USB Hub Interrupt Register 0 (HIRO)

Address: \$0059

	Bit 7	6	5	4	3	2	1	Bit 0
Read:	TXDF	RXDF	0	0	TXDIE	RXDIE	0	0
Write:							TXDFR	RXDFR
Reset:	0	0	0	0	0	0	0	0

 = Unimplemented

**Figure 14-8. USB Hub Interrupt Register 0 (HIRO)**

#### TXDF — Hub Endpoint 0 Data Transmit Flag

This read-only bit is set after the data stored in hub endpoint 0 transmit buffers have been sent and an ACK handshake packet received from the host. Once the next set of data is ready in the transmit buffers, software must clear this flag by writing a logic 1 to the TXDFR bit. To enable the next data packet transmission, TXE must also be set. If TXDF bit is not cleared, a NAK handshake will be returned in the next IN transaction. TXDF generates an interrupt request to CPU if the TXDIE bit is also set. Writing to TXDF has no effect. Reset clears this bit.

- 1 = Transmit on hub endpoint 0 has occurred
- 0 = Transmit on hub endpoint 0 has not occurred

#### RXDF — Hub Endpoint 0 Data Receive Flag

This read-only bit is set after the USB hub function has received a data packet and responded with an ACK handshake packet. Software must clear this flag by writing a logic 1 to the RXDFR bit after all data received have been read. To enable the next data packet reception, RXE must also be set. If RXDF bit is not cleared, a NAK handshake will be returned in the next OUT transaction. RXDF generates an interrupt request to CPU if the RXDIE bit is also set. Writing to RXDF has no effect. Reset clears this bit.

- 1 = Receive on hub endpoint 0 has occurred
- 0 = Receive on hub endpoint 0 has not occurred

### TXDIE — Hub Endpoint 0 Transmit Interrupt Enable

This read/write bit enables the TXDF bit to generate CPU interrupt request when set. Reset clears the TXDIE bit.

1 = TXDF CPU interrupt requests enabled

0 = TXDF CPU interrupt requests disabled

### RXDIE — Hub Endpoint 0 Receive Interrupt Enable

This read/write bit enables the RXDF bit to generate CPU interrupt request when set. Reset clears the RXDIE bit.

1 = RXDF CPU interrupt requests enabled

0 = RXDF CPU interrupt requests disabled

### TXDFR — Hub Endpoint 0 Transmit Flag Reset

Writing a logic 1 to this write-only bit will clear the TXDF bit if it is set. Reset clears this bit.

1 = Write 1 to clear the TXDF bit

0 = No effect

### RXDFR — Hub Endpoint 0 Receive Flag Reset

Writing a logic 1 to this write-only bit will clear the RXDF bit if it is set. Reset clears this bit.

1 = Write 1 to clear the RXDF bit

0 = No effect

### 14.6.7 USB Hub Control Register 0 (HCR0)

Address: \$005B

	Bit 7	6	5	4	3	2	1	Bit 0
Read:	TSEQ	STALL0	TXE	RXE	TPSIZ3	TPSIZ2	TPSIZ1	TPSIZ0
Write:								
Reset:	0	0	0	0	0	0	0	0

**Figure 14-9. USB Hub Control Register 0 (HCR0)**

#### TSEQ — Hub Endpoint 0 Transmit Sequence Bit

This read/write bit determines which type of data packet (DATA0 or DATA1) will be sent during the next IN transaction directed at endpoint 0. Toggling of this bit must be controlled by software. Reset clears this bit.

- 1 = DATA1 token active for next hub endpoint 0 transmit
- 0 = DATA0 token active for next hub endpoint 0 transmit

#### STALL0 — Hub Endpoint 0 Force Stall Bit

This read/write bit causes hub endpoint 0 to return a STALL handshake when polled by either an IN or OUT token by the host. The USB hardware clears this bit when a SETUP token is received. Reset clears this bit.

- 1 = Send STALL handshake
- 0 = Default

#### TXE — Hub Endpoint 0 Transmit Enable

This read/write bit enables a transmit to occur when the USB host controller sends an IN token to the hub endpoint 0. Software should set this bit when data is ready to be transmitted. It must be cleared by software when no more hub endpoint 0 data packets needs to be transmitted. If this bit is 0 or the TXDF is set, the USB will respond with a NAK handshake to any hub endpoint 0 IN tokens. Reset clears this bit.

- 1 = Data is ready to be sent
- 0 = Data is not ready; respond with NAK

## RXE — Hub Endpoint 0 Receive Enable

This read/write bit enables a receive to occur when the USB host controller sends an OUT token to the hub endpoint 0. Software should set this bit when data is ready to be received. It must be cleared by software when data cannot be received. If this bit is 0 or the RXDF is set, the USB will respond with a NAK handshake to any hub endpoint 0 OUT tokens. Reset clears this bit.

1 = Data is ready to be received

0 = Not ready for data; respond with NAK

## TPSIZ[3:0] — Hub Endpoint 0 Transmit Data Packet Size

These read/write bits store the number of transmit data bytes for the next IN token request for hub endpoint 0. These bits are cleared by reset.

## 14.6.8 USB Hub Endpoint 1 Control and Data Register (HCDR)

Address: \$005C

	Bit 7	6	5	4	3	2	1	Bit 0
Read:	STALL1	PNEW	PCHG5	PCHG4	PCHG3	PCHG2	PCHG1	PCHG0
Write:								
Reset:	0	0	0	0	0	0	0	0

**Figure 14-10. USB Hub Endpoint 1 Control and Data Register (HCDR)**

### STALL1 — Hub Endpoint 1 Force Stall Bit

This read/write bit causes hub endpoint 1 to return a STALL handshake when polled by the host. Reset clears this bit.

1 = Send STALL handshake

0 = Default

### PNEW — Port New Status Change

This read/write bit enables a transmit to occur when the USB Host controller sends an IN token to hub endpoint 1. Software should set this bit when there is a status change on any of the downstream ports, embedded device or hub. It must be cleared by software when there

is no status change to be reported to the host through endpoint 1. If this bit is 0, a NAK handshake will be returned for next IN token for hub endpoint 1. Reset clears this bit.

1 = Port status change bitmap is ready to be sent

0 = Port status does not change; respond with NAK

#### PCHG5–PCHG0 — Hub and Port Status Change Bitmap

These read/write bits report the status change for the hub, embedded device and the four downstream ports. The status change bitmap is returned to the host through the hub endpoint 1 if the PNEW bit is 1. These bits are cleared by reset.

Bit Name	Function	Value	Description
PCHG0	Hub status change	0	No status change in hub
		1	Hub status change detected
PCHG1	Port 1 status change	0	No status change in Port 1
		1	Port 1 status change detected
PCHG2	Port 2 status change	0	No status change in Port 2
		1	Port 2 status change detected
PCHG3	Port 3 status change	0	No status change in Port 3
		1	Port 3 status change detected
PCHG4	Port 4 status change	0	No status change in Port 4
		1	Port 4 status change detected
PCHG5	Embedded device status change	0	No status change in embedded device
		1	Embedded device status change detected

## 14.6.9 USB Hub Status Register (HSR)

Address: \$005D

	Bit 7	6	5	4	3	2	1	Bit 0
Read:	RSEQ	SETUP	TX1ST	0	RPSIZ3	RPSIZ2	RPSIZ1	RPSIZ0
Write:				TX1STR				
Reset:	X	X	X	0	X	X	X	X

X = Indeterminate       = Unimplemented

**Figure 14-11. USB Hub Status Register (HSR)**

### RSEQ — Hub Endpoint 0 Receive Sequence Bit

This read-only bit indicates the type of data packet last received for hub endpoint 0 (DATA0 or DATA1).

- 1 = DATA1 token received in last hub endpoint 0 receive
- 0 = DATA0 token received in last hub endpoint 0 receive

### SETUP — Hub SETUP Token Detect Bit

This read-only bit indicates that a valid SETUP token has been received.

- 1 = Last token received for hub endpoint 0 was a SETUP token
- 0 = Last token received for hub endpoint 0 was not a SETUP token

### TX1ST — Hub Transmit First Flag

This read-only bit is set if the hub endpoint 0 data transmit flag (TXDF) is set when the USB control logic is setting the hub endpoint 0 data receive flag (RXDF). That is, TXDF is still set at the end of an endpoint 0 reception. This bit allows the software to know that the endpoint 0 transmission happened before the endpoint 0 reception. Reset clears this bit.

- 1 = IN transaction occurred before SETUP/OUT
- 0 = IN transaction occurred after SETUP/OUT

### TX1STR — Clear Hub Transmit First Flag

Writing a logic 1 to this write-only bit will clear the TX1ST bit if it is set. Reset clears this bit.

- 1 = Write 1 to clear the TX1ST bit
- 0 = No effect



RPSIZ[3:0] — Hub Endpoint 0 Receive Data Packet Size

These read-only bits store the number of data bytes received for the last OUT or SETUP transaction for hub endpoint 0. These bits are not affected by reset.

**14.6.10 USB Hub Endpoint 0 Data Registers (HE0D0–HE0D7)**

Address:     \$0030–\$0037            HE0D0–HE0D7

	Bit 7	6	5	4	3	2	1	Bit 0
Read:	HE0Rx7	HE0Rx6	HE0Rx5	HE0Rx4	HE0Rx3	HE0Rx2	HE0Rx1	HE0Rx0
Write:	HE0Tx7	HE0Tx6	HE0Tx5	HE0Tx4	HE0Tx3	HE0Tx2	HE0Tx1	HE0Tx0
Reset:	Indeterminate after reset							

**Figure 14-12. USB Hub Endpoint 0 Data Registers (HE0D0–HE0D7)**

HE0Rx[7:0] — Hub Endpoint 0 Receive Data Buffer

These read-only bits are serially loaded with OUT token or SETUP token data directed at hub endpoint 0. The data is received by the D0+ and D0– pins.

HE0Tx[7:0] — Hub Endpoint 0 Transmit Data Buffer

These write-only buffers are loaded by software with data to be sent on the USB bus on the next IN token directed at hub endpoint 0.

**14.7 Embedded Device Function I/O Registers**

The USB embedded device function provides a set of control/status registers and twenty-four data registers that provide storage for the buffering of data between the USB embedded device function and the CPU.

## 14.7.1 USB Embedded Device Address Register (DADDR)

Address: \$0048

	Bit 7	6	5	4	3	2	1	Bit 0
Read:	DEVEN	DADD6	DADD5	DADD4	DADD3	DADD2	DADD1	DADD0
Write:								
Reset:	0	0	0	0	0	0	0	0

**Figure 14-13. USB Embedded Device Address Register (DADDR)**

### DEVEN — Enable USB Embedded Device

These bit enable or disable the embedded device function. It is used together with PEN1–PEN4 to control the enumeration sequence.

Reset clears these bits.

1 = USB Embedded Device enabled

0 = USB Embedded Device disabled

### DADD[6:0] — USB Embedded Device Function Address

These bits specify the address of the embedded device function.

Reset clears these bits.

## 14.7.2 USB Embedded Device Interrupt Register 0 (DIR0)

Address: \$0049

	Bit 7	6	5	4	3	2	1	Bit 0
Read:	TXD0F	RXD0F	0	0	TXD0IE	RXD0IE	0	0
Write:							TXD0FR	RXD0FR
Reset:	0	0	0	0	0	0	0	0

 = Unimplemented

**Figure 14-14. USB Embedded Device Interrupt Register 0 (DIR0)**

### TXD0F — Embedded Device Endpoint 0 Data Transmit Flag

This read-only bit is set after the data stored in embedded device endpoint 0 transmit buffers have been sent and an ACK handshake packet received from the host. Once the next set of data is ready in the transmit buffers, software must clear this flag by writing a logic 1 to the TXD0FR bit. To enable the next data packet transmission,

TX0E must also be set. If TXD0F bit is not cleared, a NAK handshake will be returned in the next IN transaction. TXD0F generates an interrupt request to the CPU if the TXD0IE bit is also set. Writing to TXD0F has no effect. Reset clears this bit.

1 = Transmit on embedded device endpoint 0 has occurred

0 = Transmit on embedded device endpoint 0 has not occurred

#### RXD0F — Embedded Device Endpoint 0 Data Receive Flag

This read-only bit is set after the USB embedded device module has received a data packet and responded with an ACK handshake packet. Software must clear this flag by writing a logic 1 to the RXD0FR bit after all data received have been read. To enable the next data packet reception, RX0E must also be set. If RXD0F bit is not cleared, a NAK handshake will be returned in the next OUT transaction. RXD0F generates an interrupt request to CPU if the RXD0IE bit is also set. Writing to RXD0F has no effect. Reset clears this bit.

1 = Receive on embedded device endpoint 0 has occurred

0 = Receive on embedded device endpoint 0 has not occurred

#### TXD0IE — Embedded Device Endpoint 0 Transmit Interrupt Enable

This read/write bit enables the TXD0F bit to generate CPU interrupt request when set. Reset clears the TXD0IE bit.

1 = TXD0F CPU interrupt requests enabled

0 = TXD0F CPU interrupt requests disabled

#### RXD0IE — Embedded Device Endpoint 0 Receive Interrupt Enable

This read/write bit enables the RXD0F bit to generate CPU interrupt request when set. Reset clears the RXD0IE bit.

1 = RXD0F CPU interrupt requests enabled

0 = RXD0F CPU interrupt requests disabled

#### TXD0FR — Embedded Device Endpoint 0 Transmit Flag Reset

Writing a logic 1 to this write-only bit will clear the TXD0F bit if it is set. Reset clears this bit.

1 = Write 1 to clear TXD0F bit

0 = No effect

## RXD0FR — Embedded Device Endpoint 0 Receive Flag Reset

Writing a logic 1 to this write-only bit will clear the RXD0F bit if it is set. Reset clears this bit.

- 1 = Write 1 to clear RXD0F bit
- 0 = No effect

### 14.7.3 USB Embedded Device Interrupt Register 1 (DIR1)

Address: \$004A

	Bit 7	6	5	4	3	2	1	Bit 0
Read:	TXD1F	0	0	0	TXD1IE	0	0	0
Write:							TXD1FR	
Reset:	0	0	0	0	0	0	0	0

 = Unimplemented

**Figure 14-15. USB Embedded Device Interrupt Register 1 (DIR1)**

## TXD1F — Embedded Device Endpoint 1/2 Data Transmit Flag

This read-only bit is shared by endpoint 1 and endpoint 2 of the embedded device. It is set after the data stored in the shared endpoint 1/2 transmit buffer of the embedded device have been sent and an ACK handshake packet received from the host. Once the next set of data is ready in the transmit buffers, software must clear this flag by writing a logic 1 to the TXD1FR bit. To enable the next data packet transmission, TX1E must also be set. If TXD1F bit is not cleared, a NAK handshake will be returned in the next IN transaction. TXD1F generates an interrupt request to the CPU if the TXD1IE bit is also set. Writing to TXD1F has no effect. Reset clears this bit.

- 1 = Transmit on endpoint 1 or endpoint 2 of the embedded device has occurred
- 0 = Transmit on endpoint 1 or endpoint 2 of the embedded device has not occurred

## TXD1IE — Embedded Device Endpoint 1/2 Transmit Interrupt Enable

This read/write bit enables the TXD1F bit to generate CPU interrupt request when set. Reset clears the TXD1IE bit.

- 1 = TXD1F CPU interrupt requests enabled
- 0 = TXD1F CPU interrupt requests disabled

**TXD1FR — Embedded Device Endpoint 1/2 Transmit Flag Reset**

Writing a logic 1 to this write-only bit will clear the TXD1F bit if it is set.  
 Reset clears this bit.

- 1 = Write 1 to clear TXD1F
- 0 = No effect

**14.7.4 USB Embedded Device Control Register 0 (DCR0)**

Address: \$004B

	Bit 7	6	5	4	3	2	1	Bit 0
Read:	T0SEQ	DSTALL0	TX0E	RX0E	TP0SIZ3	TP0SIZ2	TP0SIZ1	TP0SIZ0
Write:								
Reset:	0	0	0	0	0	0	0	0

**Figure 14-16. USB Embedded Device Control Register 0 (DCR0)**

**T0SEQ — Embedded Device Endpoint 0 Transmit Sequence Bit**

This read/write bit determines which type of data packet (DATA0 or DATA1) will be sent during the next IN transaction directed at endpoint 0. Toggling of this bit must be controlled by software. Reset clears this bit.

- 1 = DATA1 token active for next embedded device endpoint 0 transmit
- 0 = DATA0 token active for next embedded device endpoint 0 transmit

**DSTALL0 — Embedded Device Endpoint 0 Force Stall Bit**

This read/write bit causes embedded device endpoint 0 to return a STALL handshake when polled by either an IN or OUT token by the host. The USB hardware clears this bit when a SETUP token is received. Reset clears this bit.

- 1 = Send STALL handshake
- 0 = Default

### TX0E — Embedded Device Endpoint 0 Transmit Enable

This read/write bit enables a transmit to occur when the USB host controller sends an IN token to the embedded device endpoint 0. Software should set this bit when data is ready to be transmitted. It must be cleared by software when no more embedded device endpoint 0 data needs to be transmitted. If this bit is 0 or the TXD0F is set, the USB will respond with a NAK handshake to any embedded device endpoint 0 IN tokens. Reset clears this bit.

1 = Data is ready to be sent

0 = Data is not ready; respond with NAK

### RX0E — Embedded Device Endpoint 0 Receive Enable

This read/write bit enables a receive to occur when the USB host controller sends an OUT token to the embedded device endpoint 0. Software should set this bit when data is ready to be received. It must be cleared by software when data cannot be received. If this bit is 0 or the RXD0F is set, the USB will respond with a NAK handshake to any embedded device endpoint 0 OUT tokens. Reset clears this bit.

1 = Data is ready to be received

0 = Not ready for data; respond with NAK

### TP0SIZ[3:0] — Embedded Device Endpoint 0 Transmit Data Packet Size

These read/write bits store the number of transmit data bytes for the next IN token request for embedded device endpoint 0. These bits are cleared by reset.

### 14.7.5 USB Embedded Device Control Register 1 (DCR1)

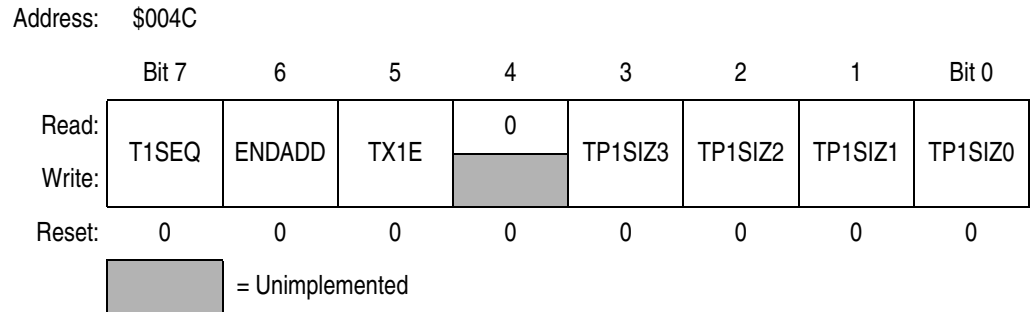

**Figure 14-17. USB Embedded Device Control Register 1 (DCR1)**

#### T1SEQ — Embedded Device Endpoint 1/2 Transmit Sequence Bit

This read/write bit determines which type of data packet (DATA0 or DATA1) will be sent during the next IN transaction directed to embedded device endpoint 1 or 2. Toggling of this bit must be controlled by software. Reset clears this bit.

1 = DATA1 token active for next embedded device endpoint 1/2 transmit

0 = DATA0 token active for next embedded device endpoint 1/2 transmit

#### ENDADD — Endpoint Address Select

This read/write bit specifies whether the data inside the DE1D0–DE1D7 registers are used for embedded device endpoint 1 or 2. If all the conditions for a successful endpoint 2 USB response to a host’s IN token are satisfied (TXD1F=0, TX1E=1, DSTALL2=0, and ENABLE2=1) except that the ENDADD bit is configured for endpoint 1, the USB responds with a NAK handshake packet. Reset clears this bit.

1 = The data buffers are used for embedded device endpoint 2

0 = The data buffers are used for embedded device endpoint 1

#### TX1E — Embedded Device Endpoint 1/2 Transmit Enable

This read/write bit enables a transmit to occur when the USB Host controller sends an IN token to endpoint 1 or endpoint 2 of the embedded device. The appropriate endpoint enable bit, ENABLE1 or ENABLE2 bit in the DCR2 register, should also be set. Software should set the TX1E bit when data is ready to be transmitted.

It must be cleared by software when no more data needs to be transmitted. If this bit is 0 or the TXD1F is set, the USB will respond with a NAK handshake to any endpoint 1 or endpoint 2 directed IN tokens. Reset clears this bit.

1 = Data is ready to be sent.

0 = Data is not ready; respond with NAK.

### TP1SIZ[3:0] — Embedded Device Endpoint 1/2 Transmit Data Packet Size

These read/write bits store the number of transmit data bytes for the next IN token request for embedded device endpoint 1 or endpoint 2. These bits are cleared by reset.

## 14.7.6 USB Embedded Device Control Register 2 (DCR2)

Address: \$0047

	Bit 7	6	5	4	3	2	1	Bit 0
Read:	0	0	0	0	ENABLE2	ENABLE1	DSTALL2	DSTALL1
Write:								
Reset:	0	0	0	0	0	0	0	0

 = Unimplemented

**Figure 14-18. USB Embedded Device Control Register 2 (DCR2)**

### ENABLE2 — Embedded Device Endpoint 2 Enable

This read/write bit enables embedded device endpoint 2 and allows the USB to respond to IN packets addressed to this endpoint. Reset clears this bit.

1 = Embedded device endpoint 2 is enabled and can respond to an IN token

0 = Embedded device endpoint 2 is disabled

### ENABLE1 — Embedded Device Endpoint 1 Enable

This read/write bit enables embedded device endpoint 1 and allows the USB to respond to IN packets addressed to this endpoint. Reset clears this bit.

1 = Embedded device endpoint 1 is enabled and can respond to an IN token

0 = Embedded device endpoint 1 is disabled



**DSTALL2 — Embedded Device Endpoint 2 Force Stall Bit**

This read/write bit causes embedded device endpoint 2 to return a STALL handshake when polled by either an IN or OUT token by the USB host controller. Reset clears this bit.

- 1 = Send STALL handshake
- 0 = Default

**DSTALL1 — Embedded Device Endpoint 1 Force Stall Bit**

This read/write bit causes embedded device endpoint 1 to return a STALL handshake when polled by either an IN or OUT token by the USB host controller. Reset clears this bit.

- 1 = Send STALL handshake
- 0 = Default

**14.7.7 USB Embedded Device Status Register (DSR)**

Address: \$004D

	Bit 7	6	5	4	3	2	1	Bit 0
Read:	DRSEQ	DSETUP	DTX1ST	0	RP0SIZ3	RP0SIZ2	RP0SIZ1	RP0SIZ0
Write:				DTX1STR				
Reset:	0	0	0	0	0	0	0	0

 = Unimplemented

**Figure 14-19. USB Embedded Device Status Register (DSR)**

**DRSEQ — Embedded Device Endpoint 0 Receive Sequence Bit**

This read-only bit indicates the type of data packet last received for embedded device endpoint 0 (DATA0 or DATA1).

- 1 = DATA1 token received in last embedded device endpoint 0 receive
- 0 = DATA0 token received in last embedded device endpoint 0 receive

**DSETUP — Embedded Device SETUP Token Detect Bit**

This read-only bit indicates that a valid SETUP token has been received.

- 1 = Last token received for endpoint 0 was a SETUP token
- 0 = Last token received for endpoint 0 was not a SETUP token

### DTX1ST — Embedded Device Transmit First Flag

This read-only bit is set if the embedded device endpoint 0 data transmit flag (TXD0F) is set when the USB control logic is setting the embedded device endpoint 0 data receive flag (RXD0F). That is, TXD0F is still set at the end of an endpoint 0 reception. This bit allows the software to know that the endpoint 0 transmission happened before the endpoint 0 reception. Reset clears this bit.

1 = IN transaction occurred before SETUP/OUT

0 = IN transaction occurred after SETUP/OUT

### DTX1STR — Clear Transmit First Flag

Writing a logic 1 to this write-only bit will clear the DTX1ST bit if it is set. Reset clears this bit.

1 = Write 1 to clear DTX1ST bit

0 = No effect

### RP0SIZ[3:0] — Embedded Device Endpoint 0 Receive Data Packet Size

These read-only bits store the number of data bytes received for the last OUT or SETUP transaction for embedded device endpoint 0. These bits are not affected by reset.

### 14.7.8 USB Embedded Device Endpoint 0 Data Registers (DE0D0–DE0D7)

Address:	\$0020–\$0027	DE0D0–DE0D7						
	Bit 7	6	5	4	3	2	1	Bit 0
Read:	DE0Rx7	DE0Rx6	DE0Rx5	DE0Rx4	DE0Rx3	DE0Rx2	DE0Rx1	DE0Rx0
Write:	DE0Tx7	DE0Tx6	DE0Tx5	DE0Tx4	DE0Tx3	DE0Tx2	DE0Tx1	DE0Tx0
Reset:	Indeterminate after reset							

**Figure 14-20. USB Embedded Device Endpoint 0 Data Registers (DE0D0–DE0D7)**

**DE0Rx[7:0]** — Embedded Device Endpoint 0 Receive Data Buffer

These read-only bits are serially loaded with OUT token or SETUP token data directed at embedded device endpoint 0. The data is received by the D0+ and D0– pins.

**DE0Tx[7:0]** — Embedded Device Endpoint 0 Transmit Data Buffer

These write-only buffers are loaded by software with data to be sent on the USB bus on the next IN token directed at embedded device endpoint 0.

### 14.7.9 USB Embedded Device Endpoint 1/2 Data Registers (DE1D0–DE1D7)

Address:	\$0028–\$002F	DE1D0–DE1D7						
	Bit 7	6	5	4	3	2	1	Bit 0
Read:								
Write:	DE1Tx7	DE1Tx6	DE1Tx5	DE1Tx4	DE1Tx3	DE1Tx2	DE1Tx1	DE1Tx0
Reset:	Indeterminate after reset							

**Figure 14-21. USB Embedded Device Endpoint 1/2 Data Registers (DE1D0–DE1D7)**

**DE1Tx[7:0]** — Embedded Device Endpoint 1/ Endpoint 2 Transmit Data Buffer

These write-only buffers are loaded by software with data to be sent on the USB bus on the next IN token directed at endpoint 1 or endpoint 2 of the embedded device. These buffers are shared by embedded device endpoints 1 and 2 and depend on proper configuration of the ENDADD bit.

# Universal Serial Bus Module (USB)

## Section 15. Multi-Master IIC Interface (MMIIC)

### 15.1 Contents

15.2	Introduction	221
15.3	Features	222
15.4	I/O Pins	222
15.5	Multi-Master IIC Registers	223
15.5.1	Multi-Master IIC Address Register (MMADR)	224
15.5.2	Multi-Master IIC Control Register (MMCR)	225
15.5.3	Multi-Master IIC Master Control Register (MIMCR)	226
15.5.4	Multi-Master IIC Status Register (MMSR)	228
15.5.5	Multi-Master IIC Data Transmit Register (MMDTR)	230
15.5.6	Multi-Master IIC Data Receive Register (MMDRR)	231
15.6	Programming Considerations	232

### 15.2 Introduction

This Multi-master IIC (MMIIC) Interface is designed for internal serial communication between the MCU and other IIC devices. A hardware circuit generates "start" and "stop" signal, while byte by byte data transfer is interrupt driven by the software algorithm. Therefore, it can greatly help the software in dealing with other devices to have higher system efficiency in a typical digital monitor system.

This module not only can be applied in internal communications, but can also be used as a typical command reception serial bus for factory setup and alignment purposes. It also provides the flexibility of hooking additional devices to an existing system for future expansion without adding extra hardware.

## Multi-Master IIC Interface (MMIIC)

This Multi-master IIC module uses the IIC\_SCL clock line and the IIC\_SDA data line to communicate with external DDC host or IIC interface. These two pins are shared with port pins PTD6 and PTD7 respectively. The outputs of IIC\_SDA and IIC\_SCL pins are open-drain type — no clamping diode is connected between the pin and internal  $V_{DD}$ . The maximum data rate typically is 750k-bps. The maximum communication length and the number of devices that can be connected are limited by a maximum bus capacitance of 400pF.

### 15.3 Features

- Compatibility with multi-master IIC bus standard
- Software controllable acknowledge bit generation
- Interrupt driven byte by byte data transfer
- Calling address identification interrupt
- Auto detection of R/W bit and switching of transmit or receive mode
- Detection of START, repeated START, and STOP signals
- Auto generation of START and STOP condition in master mode
- Arbitration loss detection and No-ACK awareness in master mode
- 8 selectable baud rate master clocks
- Automatic recognition of the received acknowledge bit

### 15.4 I/O Pins

The MMIIC module uses two I/O pins, shared with standard port I/O pins. The full name of the MMIIC I/O pins are listed in [Table 15-1](#). The generic pin name appear in the text that follows.

**Table 15-1. Pin Name Conventions**

MMIIC Generic Pin Names:	Full MCU Pin Names:	Pin Selected for IIC Function By:
SDA	PTD7/IIC_SDA	IICDATE bit in PDCR (\$0069)
SCL	PTD6/IIC_SCL	IICSCLE bit in PDCR (\$0069)

Addr.	Register Name		Bit 7	6	5	4	3	2	1	Bit 0
\$006A	Multi-Master IIC Master Control Register (MIMCR)	Read:	MMALIF	MMNAKIF	MMBB	MMAST	MMRW	MMBR2	MMBR1	MMBR0
		Write:	0	0						
		Reset:	0	0	0	0	0	0	0	0
\$006B	Multi-Master IIC Address Register (MMADR)	Read:	MMAD7	MMAD6	MMAD5	MMAD4	MMAD3	MMAD2	MMAD1	MMEXTAD
		Write:								
		Reset:	1	0	1	0	0	0	0	0
\$006C	Multi-Master IIC Control Register (MMCR)	Read:	MMEN	MMIEN	0	0	MMTXAK	0	0	0
		Write:								
		Reset:	0	0	0	0	0	0	0	0
\$006D	Multi-Master IIC Status Register (MMSR)	Read:	MMRXIF	MMTXIF	MMATCH	MMSRW	MMRXAK	0	MMTXBE	MMRXBF
		Write:	0	0						
		Reset:	0	0	0	0	1	0	1	0
\$006E	Multi-Master IIC Data Transmit Register (MMDTR)	Read:	MMTD7	MMTD6	MMTD5	MMTD4	MMTD3	MMTD2	MMTD1	MMTD0
		Write:								
		Reset:	1	1	1	1	1	1	1	1
\$006F	Multi-Master IIC Data Receive Register (MMDRR)	Read:	MMRD7	MMRD6	MMRD5	MMRD4	MMRD3	MMRD2	MMRD1	MMRD0
		Write:								
		Reset:	0	0	0	0	0	0	0	0

= Unimplemented

**Figure 15-1. MMIIC I/O Register Summary**

## 15.5 Multi-Master IIC Registers

Six registers are associated with the Multi-master IIC module, they are outlined in the following sections.

## 15.5.1 Multi-Master IIC Address Register (MMADR)

Address: \$006B

	Bit 7	6	5	4	3	2	1	Bit 0
Read:	MMAD7	MMAD6	MMAD5	MMAD4	MMAD3	MMAD2	MMAD1	MMEXTAD
Write:								
Reset:	1	0	1	0	0	0	0	0

**Figure 15-2. Multi-Master IIC Address Register (MMADR)**

### MMAD[7:1] — Multi-Master Address

These seven bits can be the MMIIC interface’s own specific slave address in slave mode or the calling address when in master mode. Software must update it as the calling address while entering the master mode and restore its own slave address after the master mode is relinquished. Reset sets a default value of \$A0.

### MMEXTAD — Multi-Master Expanded Address

This bit is set to expand the address of the MMIIC in slave mode. When set, the MMIIC will acknowledge the general call address \$00 and the matched 4-bit address, MMAD[7:4]. Reset clears this bit. For example, when MMADR is configured as:

MMAD7	MMAD6	MMAD5	MMAD4	MMAD3	MMAD2	MMAD1	MMEXTAD
1	1	0	1	X	X	X	1

The MMIIC module will respond to the calling address:

Bit 7	6	5	4	3	2	Bit 1
1	1	0	1	X	X	X

or the general calling address:

0	0	0	0	0	0	0
---	---	---	---	---	---	---

where X = don’t care; bit 0 of the calling address is the MMRW bit from the calling master.

1 = MMIIC responds to address \$00 and \$MMAD[7:4]

0 = MMIIC responds to address \$MMAD[7:1]



### 15.5.2 Multi-Master IIC Control Register (MMCR)

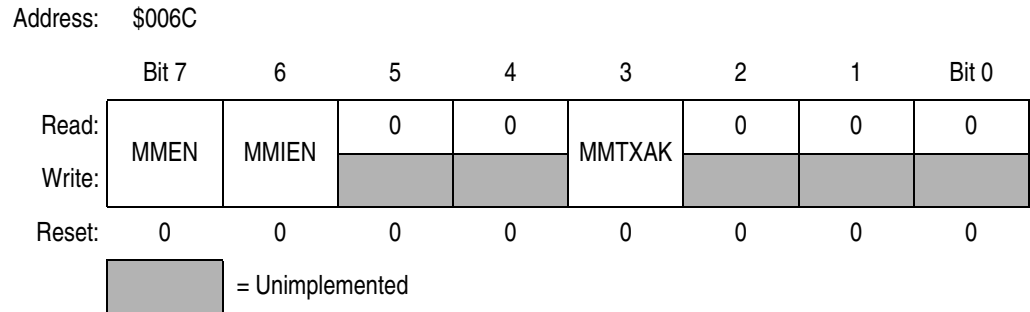

**Figure 15-3. Multi-Master IIC Control Register (MMCR)**

#### MMEN — Multi-Master IIC Enable

This bit is set to enable the Multi-master IIC module. When MMEN = 0, module is disabled and all flags will restore to its power-on default states. Reset clears this bit.

- 1 = MMIIC module enabled
- 0 = MMIIC module disabled

#### MMIEN — Multi-Master IIC Interrupt Enable

When this bit is set, the MMTXIF, MMRXIF, MMALIF, and MMNAKIF flags are enabled to generate an interrupt request to the CPU. When MMIEN is cleared, the these flags are prevented from generating an interrupt request. Reset clears this bit.

- 1 = MMTXIF, MMRXIF, MMALIF, and/or MMNAKIF bit set will generate interrupt request to CPU
- 0 = MMTXIF, MMRXIF, MMALIF, and/or MMNAKIF bit set will not generate interrupt request to CPU

#### MMTXAK — Transmit Acknowledge Enable

This bit is set to disable the MMIIC from sending out an acknowledge signal to the bus at the 9th clock bit after receiving 8 data bits. When MMTXAK is cleared, an acknowledge signal will be sent at the 9th clock bit. Reset clears this bit.

- 1 = MMIIC does not send acknowledge signals at 9th clock bit
- 0 = MMIIC sends acknowledge signal at 9th clock bit

## 15.5.3 Multi-Master IIC Master Control Register (MIMCR)

Address: \$006A

	Bit 7	6	5	4	3	2	1	Bit 0
Read:	MMALIF	MMNAKIF	MMBB	MMAST	MMRW	MMBR2	MMBR1	MMBR0
Write:	0	0						
Reset:	0	0	0	0	0	0	0	0

**Figure 15-4. Multi-Master IIC Master Control Register (MIMCR)**

### MMALIF — Multi-Master Arbitration Lost Interrupt Flag

This flag is set when software attempt to set MMAST but the MMBB has been set by detecting the start condition on the lines or when the MMIIC is transmitting a "1" to SDA line but detected a "0" from SDA line in master mode – an arbitration loss. This bit generates an interrupt request to the CPU if the MMIEN bit in MMCR is also set. This bit is cleared by writing "0" to it or by reset.

- 1 = Lost arbitration in master mode
- 0 = No arbitration lost

### MMNAKIF — No Acknowledge Interrupt Flag

This flag is only set in master mode (MMAST = 1) when there is no acknowledge bit detected after one data byte or calling address is transferred. This flag also clears MMAST. MMNAKIF generates an interrupt request to CPU if the MMIEN bit in MMCR is also set. This bit is cleared by writing "0" to it or by reset.

- 1 = No acknowledge bit detected
- 0 = Acknowledge bit detected

### MMBB — Bus Busy Flag

This flag is set after a start condition is detected (bus busy), and is cleared when a stop condition (bus idle) is detected or the MMIIC is disabled. Reset clears this bit.

- 1 = Start condition detected
- 0 = Stop condition detected or MMIIC is disabled

### MMAST — Master Control Bit

This bit is set to initiate a master mode transfer. In master mode, the module generates a start condition to the SDA and SCL lines, followed by sending the calling address stored in MMADR.

When the MMAST bit is cleared by MMNAKIF set (no acknowledge) or by software, the module generates the stop condition to the lines after the current byte is transmitted.

If an arbitration loss occurs (MMALIF = 1), the module reverts to slave mode by clearing MMAST, and releasing SDA and SCL lines immediately.

This bit is cleared by writing "0" to it or by reset.

1 = Master mode operation

0 = Slave mode operation

### MMRW — Master Read/Write

This bit will be transmitted out as bit 0 of the calling address when the module sets the MMAST bit to enter master mode. The MMRW bit determines the transfer direction of the data bytes that follows. When it is "1", the module is in master receive mode. When it is "0", the module is in master transmit mode. Reset clears this bit.

1 = Master mode receive

0 = Master mode transmit

### MMBR2–MMBR0 — Baud Rate Select

These three bits select one of eight clock rates as the master clock when the module is in master mode.

Since this master clock is derived the CPU bus clock, the user program should not execute the WAIT instruction when the MMIIC module in master mode. This will cause the SDA and SCL lines to hang, as the WAIT instruction places the MCU in wait mode, with CPU clock is halted. These bits are cleared upon reset. (See [Table 15-2 . Baud Rate Select.](#))

**Table 15-2. Baud Rate Select**

MMBR2	MMBR1	MMBR0	Baud Rate
0	0	0	750k
0	0	1	375k
0	1	0	187.5k
0	1	1	93.75k
1	0	0	46.875k
1	0	1	23.437k
1	1	0	11.719k
1	1	1	5.859k

NOTE:  
CPU bus clock is external clock ÷ 4 = 6MHz

## 15.5.4 Multi-Master IIC Status Register (MMSR)

Address: \$006D

	Bit 7	6	5	4	3	2	1	Bit 0
Read:	MMRXIF	MMTXIF	MMATCH	MMSRW	MMRXAK	0	MMTXBE	MMRXBF
Write:	0	0						
Reset:	0	0	0	0	1	0	1	0

 = Unimplemented

**Figure 15-5. Multi-Master IIC Status Register (MMSR)**

### MMRXIF — Multi-Master IIC Receive Interrupt Flag

This flag is set after the data receive register (MMDRR) is loaded with a new received data. Once the MMDRR is loaded with received data, no more received data can be loaded to the MMDRR register until the CPU reads the data from the MMDRR to clear MMRXBF flag.

MMRXIF generates an interrupt request to CPU if the MMIEN bit in MMCR is also set. This bit is cleared by writing "0" to it or by reset; or when the MMEN = 0.

1 = New data in data receive register (MMDRR)

0 = No data received

### MMTXIF — Multi-Master Transmit Interrupt Flag

This flag is set when data in the data transmit register (MMDTR) is downloaded to the output circuit, and that new data can be written to the MMDTR. MMTXIF generates an interrupt request to CPU if the MMIEN bit in MMCR is also set. This bit is cleared by writing "0" to it or when the MMEN = 0.

- 1 = Data transfer completed
- 0 = Data transfer in progress

### MMATCH — Multi-Master Address Match

This flag is set when the received data in the data receive register (MMDRR) is an calling address which matches with the address or its extended addresses (MMEXTAD=1) specified in the MMADR register.

- 1 = Received address matches MMADR
- 0 = Received address does not match

### MMSRW — Multi-Master Slave Read/Write

This bit indicates the data direction when the module is in slave mode. It is updated after the calling address is received from a master device. MMSRW = 1 when the calling master is reading data from the module (slave transmit mode). MMSRW = 0 when the master is writing data to the module (receive mode).

- 1 = Slave mode transmit
- 0 = Slave mode receive

### MMRXAK — Multi-Master Receive Acknowledge

When this bit is cleared, it indicates an acknowledge signal has been received after the completion of 8 data bits transmission on the bus. When MMRXAK is set, it indicates no acknowledge signal has been detected at the 9th clock; the module will release the SDA line for the master to generate "stop" or "repeated start" condition. Reset sets this bit.

- 1 = No acknowledge signal received at 9th clock bit
- 0 = Acknowledge signal received at 9th clock bit

## MMTXBE — Multi-Master Transmit Buffer Empty

This flag indicates the status of the data transmit register (MMDTR). When the CPU writes the data to the MMDTR, the MMTXBE flag will be cleared. MMTXBE is set when MMDTR is emptied by a transfer of its data to the output circuit. Reset sets this bit.

- 1 = Data transmit register empty
- 0 = Data transmit register full

## MMRXBF — Multi-Master Receive Buffer Full

This flag indicates the status of the data receive register (MMDRR). When the CPU reads the data from the MMDRR, the MMRXBF flag will be cleared. MMRXBF is set when MMDRR is full by a transfer of data from the input circuit to the MMDRR. Reset clears this bit.

- 1 = Data receive register full
- 0 = Data receive register empty

### 15.5.5 Multi-Master IIC Data Transmit Register (MMDTR)

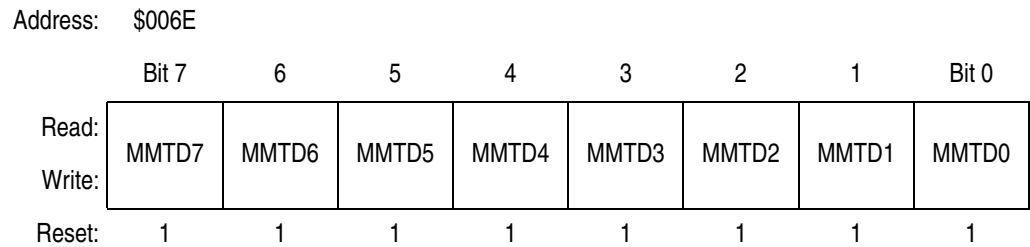

**Figure 15-6. Multi-Master IIC Data Transmit Register (MMDTR)**

When the MMIIC module is enabled, MMEN = 1, data written into this register depends on whether module is in master or slave mode.

In slave mode, the data in MMDTR will be transferred to the output circuit when:

- the module detects a matched calling address (MMATCH = 1), with the calling master requesting data (MMSRW = 1); or
- the previous data in the output circuit has been transmitted and the receiving master returns an acknowledge bit, indicated by a received acknowledge bit (MMRXAK = 0).

If the calling master does not return an acknowledge bit ( $MMRXAK = 1$ ), the module will release the SDA line for master to generate a "stop" or "repeated start" condition. The data in the MMDTR will not be transferred to the output circuit until the next calling from a master. The transmit buffer empty flag remains cleared ( $MMTXBE = 0$ ).

In master mode, the data in MMDTR will be transferred to the output circuit when:

- the module receives an acknowledge bit ( $MMRXAK = 0$ ), after setting master transmit mode ( $MMRW = 0$ ), and the calling address has been transmitted; or
- the previous data in the output circuit has been transmitted and the receiving slave returns an acknowledge bit, indicated by a received acknowledge bit ( $MMRXAK = 0$ ).

If the slave does not return an acknowledge bit ( $MMRXAK = 1$ ), the master will generate a "stop" or "repeated start" condition. The data in the MMDTR will not be transferred to the output circuit. The transmit buffer empty flag remains cleared ( $MMTXBE = 0$ ).

The sequence of events for slave transmit and master transmit are illustrated in [Figure 15-8](#).

### 15.5.6 Multi-Master IIC Data Receive Register (MMDRR)

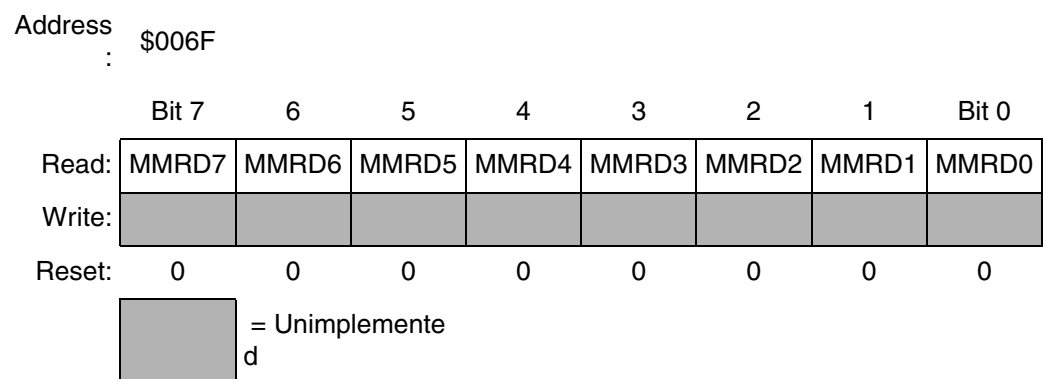

**Figure 15-7. Multi-Master IIC Data Receive Register (MMDRR)**

When the MMIIC module is enabled,  $MMEN = 1$ , data in this read-only register depends on whether module is in master or slave mode.

In slave mode, the data in MMDRR is:

- the calling address from the master when the address match flag is set (MMATCH = 1); or
- the last data received when MMATCH = 0.

In master mode, the data in the MMDRR is:

- the last data received.

When the MMDRR is read by the CPU, the receive buffer full flag is cleared (MMRXBF = 0), and the next received data is loaded to the MMDRR. Each time when new data is loaded to the MMDRR, the MMRXIF interrupt flag is set, indicating that new data is available in MMDRR.

The sequence of events for slave receive and master receive are illustrated in [Figure 15-8](#).

### 15.6 Programming Considerations

When the MMIIC module detects an arbitration loss in master mode, it will release both SDA and SCL lines immediately. But if there are no further STOP conditions detected, the module will hang up. Therefore, it is recommended to have time-out software to recover from such ill condition. The software can start the time-out counter by looking at the MMBB (Bus Busy) flag in the MIMCR and reset the counter on the completion of one byte transmission. If a time-out occur, software can clear the MMEN bit (disable MMIIC module) to release the bus, and hence clearing the MMBB flag. This is the only way to clear the MMBB flag by software if the module hangs up due to a no STOP condition received. The MMIIC can resume operation again by setting the MMEN bit.



(a) Master Transmit Mode

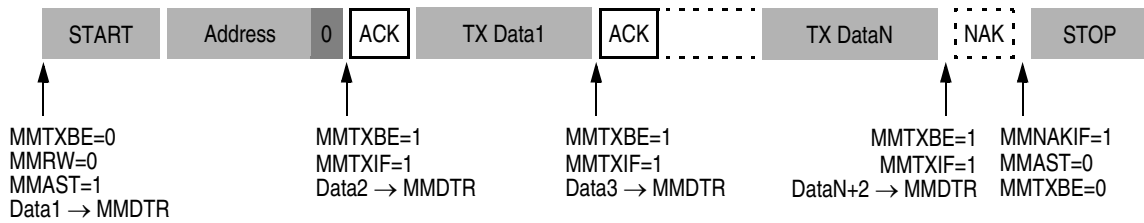

(b) Master Receive Mode

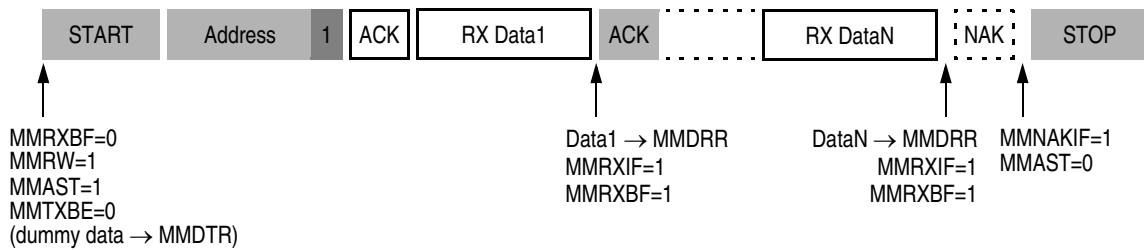

(c) Slave Transmit Mode

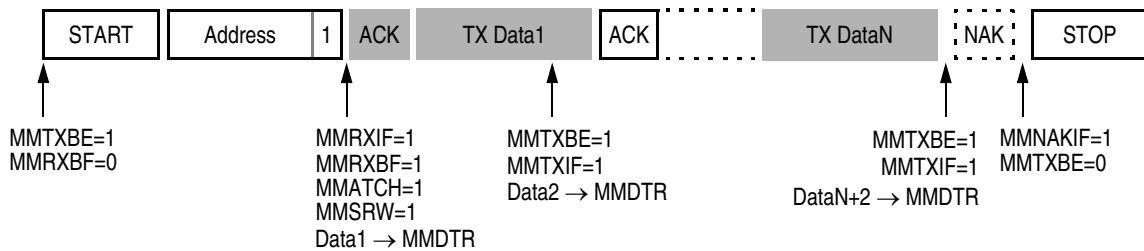

(d) Slave Receive Mode

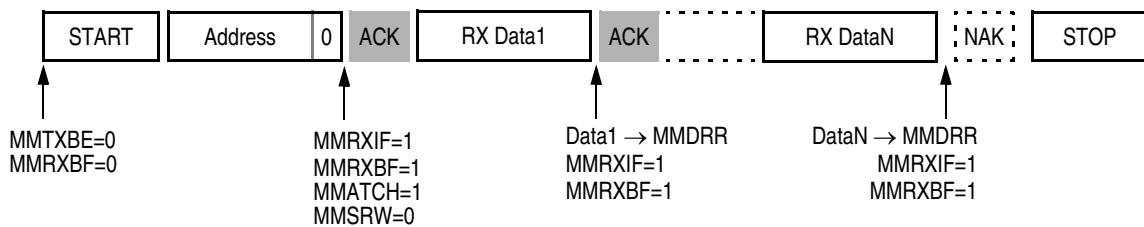

KEY: shaded data packets indicate a transmit by the MCU's MMIIC module

**Figure 15-8. Data Transfer Sequences for Master/Slave Transmit/Receive Modes**



## Section 16. DDC12AB Interface

### 16.1 Contents

16.2	Introduction	235
16.3	Features	236
16.4	I/O Pins	236
16.5	DDC Protocols	238
16.6	DDC Registers	238
16.6.1	DDC Address Register (DDCADR)	238
16.6.2	DDC2 Address Register (DDC2ADR)	239
16.6.3	DDC Control Register (DDCCR)	240
16.6.4	DDC Master Control Register (DDCMCR)	241
16.6.5	DDC Status Register (DDCSR)	244
16.6.6	DDC Data Transmit Register (DDCDTR)	246
16.6.7	DDC Data Receive Register (DDCDRR)	247
16.7	Programming Considerations	248

### 16.2 Introduction

This DDC12AB Interface module is used by the digital monitor to show its identification information to the video controller. It contains DDC1 hardware and a two-wire, bidirectional serial bus which is fully compatible with multi-master IIC bus protocol to support DDC2AB interface.

This module not only can be applied in internal communications, but can also be used as a typical command reception serial bus for factory setup and alignment purposes. It also provides the flexibility of hooking additional devices to an existing system for future expansion without adding extra hardware.

This DDC12AB module uses the DDCSCL clock line and the DDCSDA data line to communicate with external DDC host or IIC interface. These two pins are shared with port pins PTD4 and PTD5 respectively. The outputs of DDCSDA and DDCSCL pins are open-drain type — no clamping diode is connected between the pin and internal  $V_{DD}$ . The maximum data rate typically is 100k-bps. The maximum communication length and the number of devices that can be connected are limited by a maximum bus capacitance of 400pF.

## 16.3 Features

- DDC1 hardware
- Compatibility with multi-master IIC bus standard
- Software controllable acknowledge bit generation
- Interrupt driven byte by byte data transfer
- Calling address identification interrupt
- Auto detection of R/W bit and switching of transmit or receive mode
- Detection of START, repeated START, and STOP signals
- Auto generation of START and STOP condition in master mode
- Arbitration loss detection and No-ACK awareness in master mode
- 8 selectable baud rate master clocks
- Automatic recognition of the received acknowledge bit

## 16.4 I/O Pins

The DDC12AB module uses two I/O pins, shared with standard port I/O pins. The full name of the DDC12AB I/O pins are listed in [Table 16-1](#). The generic pin name appear in the text that follows.

**Table 16-1. Pin Name Conventions**

DDC12AB Generic Pin Names:	Full MCU Pin Names:	Pin Selected for DDC Function By:
SDA	PTD5/DDCSDA	DDCDATE bit in PDCR (\$0069)
SCL	PTD4/DDCSCL	DDCSCLE bit in PDCR (\$0069)

Addr.	Register Name		Bit 7	6	5	4	3	2	1	Bit 0
\$0016	DDC Master Control Register (DDCMCR)	Read:	ALIF	NAKIF	BB	MAST	MRW	BR2	BR1	BR0
		Write:	0	0						
		Reset:	0	0	0	0	0	0	0	0
\$0017	DDC Address Register (DDCADR)	Read:	DAD7	DAD6	DAD5	DAD4	DAD3	DAD2	DAD1	EXTAD
		Write:								
		Reset:	1	0	1	0	0	0	0	0
\$0018	DDC Control Register (DDCCR)	Read:	DEN	DIEN	0	0	TXAK	SCLIEN	DDC1EN	0
		Write:								
		Reset:	0	0	0	0	0	0	0	0
\$0019	DDC Status Register (DDCSR)	Read:	RXIF	TXIF	MATCH	SRW	RXAK	SCLIF	TXBE	RXBF
		Write:	0	0				0		
		Reset:	0	0	0	0	1	0	1	0
\$001A	DDC Data Transmit Register (DDCDTR)	Read:	DTD7	DTD6	DTD5	DTD4	DTD3	DTD2	DTD1	DTD0
		Write:								
		Reset:	1	1	1	1	1	1	1	1
\$001B	DDC Data Receive Register (DDCDRR)	Read:	DRD7	DRD6	DRD5	DRD4	DRD3	DRD2	DRD1	DRD0
		Write:								
		Reset:	0	0	0	0	0	0	0	0
\$001C	DDC2 Address Register (DDC2ADR)	Read:	D2AD7	D2AD6	D2AD5	D2AD4	D2AD3	D2AD2	D2AD1	0
		Write:								
		Reset:	0	0	0	0	0	0	0	0

= Unimplemented

**Figure 16-1. DDC I/O Register Summary**

## 16.5 DDC Protocols

In DDC1 protocol communication, the module is in transmit mode. The data written to the transmit register is continuously clocked out to the SDA line by the rising edge of the Vsync input signal. During DDC1 communication, a falling transition on the SCL line can be detected to generate an interrupt to the CPU for mode switching.

In DDC2AB protocol communication, the module can be either in transmit mode or in receive mode, controlled by the calling master.

In DDC2 protocol communication, the module will act as a standard IIC module, able to act as a master or a slave device.

## 16.6 DDC Registers

Seven registers are associated with the DDC module, they are outlined in the following sections.

### 16.6.1 DDC Address Register (DDCADR)

Address: \$0017

	Bit 7	6	5	4	3	2	1	Bit 0
Read:	DAD7	DAD6	DAD5	DAD4	DAD3	DAD2	DAD1	EXTAD
Write:								
Reset:	1	0	1	0	0	0	0	0

**Figure 16-2. DDC Address Register (DDCADR)**

#### DAD[7:1] — DDC Address

These seven bits can be the DDC2 interface's own specific slave address in slave mode or the calling address when in master mode. Software must update it as the calling address while entering the master mode and restore its own slave address after the master mode is relinquished. Reset sets a default value of \$A0.

### EXTAD — DDC Expanded Address

This bit is set to expand the address of the DDC in slave mode. When set, the DDC will acknowledge the general call address \$00 and the matched 4-bit address, DAD[7:4]. Reset clears this bit.

For example, when DDCADR is configured as:

DAD7	DAD6	DAD5	DAD4	DAD3	DAD2	DAD1	EXTAD
1	1	0	1	X	X	X	1

The DDC module will respond to the calling address:

Bit 7	6	5	4	3	2	Bit 1
1	1	0	1	X	X	X

or the general calling address:

0	0	0	0	0	0	0
---	---	---	---	---	---	---

where X = don't care; bit 0 of the calling address is the MRW bit from the calling master.

1 = DDC responds to address \$00 and \$DAD[7:4]

0 = DDC responds to address \$DAD[7:1]

### 16.6.2 DDC2 Address Register (DDC2ADR)

Address: \$001C

	Bit 7	6	5	4	3	2	1	Bit 0
Read:	D2AD7	D2AD6	D2AD5	D2AD4	D2AD3	D2AD2	D2AD1	0
Write:								
Reset:	0	0	0	0	0	0	0	0

**Figure 16-3. DDC2 Address Register (DDC2ADR)**

#### D2AD[7:1] — DDC2 Address

These seven bits represent the second slave address for the DDC2BI protocol. D2AD[7:1] should be set to the same value as DAD[7:1] in DDCADR if user application do not use DDC2BI. Reset clears all bits this register.

## 16.6.3 DDC Control Register (DDCCR)

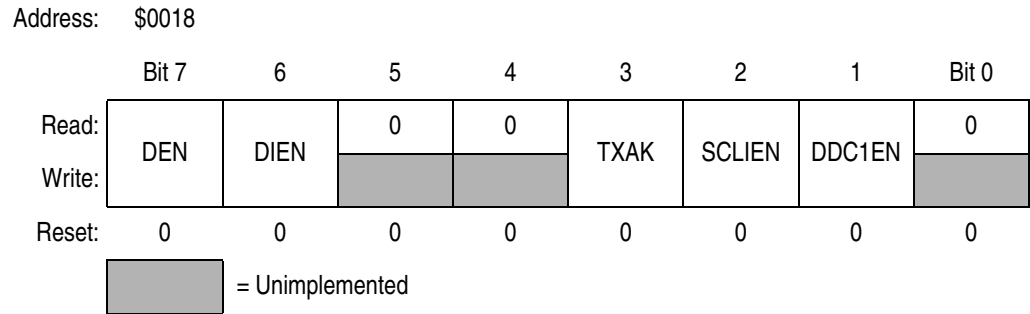

**Figure 16-4. DDC Control Register (DDCCR)**

### DEN — DDC Enable

This bit is set to enable the DDC module. When DEN = 0, module is disabled and all flags will restore to its power-on default states. Reset clears this bit.

- 1 = DDC module enabled
- 0 = DDC module disabled

### DIEN — DDC Interrupt Enable

When this bit is set, the TXIF, RXIF, ALIF, and NAKIF flags are enabled to generate an interrupt request to the CPU. When DIEN is cleared, the these flags are prevented from generating an interrupt request. Reset clears this bit.

- 1 = TXIF, RXIF, ALIF, and/or NAKIF bit set will generate interrupt request to CPU
- 0 = TXIF, RXIF, ALIF, and/or NAKIF bit set will not generate interrupt request to CPU

### TXAK — Transmit Acknowledge Enable

This bit is set to disable the DDC from sending out an acknowledge signal to the bus at the 9th clock bit after receiving 8 data bits. When TXAK is cleared, an acknowledge signal will be sent at the 9th clock bit. Reset clears this bit.

- 1 = DDC does not send acknowledge signals at 9th clock bit
- 0 = DDC sends acknowledge signal at 9th clock bit



### SCLIEN — SCL Interrupt Enable

When this bit is set, the SCLIF flag is enabled to generate an interrupt request to the CPU. When SCLIEN is cleared, SCLIF is prevented from generating an interrupt request. Reset clears this bit.

- 1 = SCLIF bit set will generate interrupt request to CPU
- 0 = SCLIF bit set will not generate interrupt request to CPU

### DDC1EN — DDC1 Protocol Enable

This bit is set to enable DDC1 protocol. The DDC1 protocol will use the Vsync input (from sync processor) as the master clock input to the DDC module. Vsync rising-edge will continuously clock out the data to the output circuit. No calling address comparison is performed. The SRW bit in DDC status register (DDCSR) will always read as "1". Reset clears this bit.

- 1 = DDC1 protocol enabled
- 0 = DDC1 protocol disabled

## 16.6.4 DDC Master Control Register (DDCMCR)

Address: \$0016

	Bit 7	6	5	4	3	2	1	Bit 0
Read:	ALIF	NAKIF	BB	MAST	MRW	BR2	BR1	BR0
Write:	0	0						
Reset:	0	0	0	0	0	0	0	0

**Figure 16-5. DDC Master Control Register (DDCMCR)**

### ALIF — DDC Arbitration Lost Interrupt Flag

This flag is set when software attempt to set MAST but the BB has been set by detecting the start condition on the lines or when the DDC is transmitting a "1" to SDA line but detected a "0" from SDA line in master mode – an arbitration loss. This bit generates an interrupt request to the CPU if the DIEN bit in DDCCR is also set. This bit is cleared by writing "0" to it or by reset.

- 1 = Lost arbitration in master mode
- 0 = No arbitration lost

### NAKIF — No Acknowledge Interrupt Flag

This flag is only set in master mode (MAST = 1) when there is no acknowledge bit detected after one data byte or calling address is transferred. This flag also clears MAST. NAKIF generates an interrupt request to CPU if the DIEN bit in DDCCR is also set. This bit is cleared by writing "0" to it or by reset.

1 = No acknowledge bit detected

0 = Acknowledge bit detected

### BB — Bus Busy Flag

This flag is set after a start condition is detected (bus busy), and is cleared when a stop condition (bus idle) is detected or the DDC is disabled. Reset clears this bit.

1 = Start condition detected

0 = Stop condition detected or DDC is disabled

### MAST — Master Control Bit

This bit is set to initiate a master mode transfer. In master mode, the module generates a start condition to the SDA and SCL lines, followed by sending the calling address stored in DDCCADR.

When the MAST bit is cleared by NAKIF set (no acknowledge) or by software, the module generates the stop condition to the lines after the current byte is transmitted.

If an arbitration loss occurs (ALIF = 1), the module reverts to slave mode by clearing MAST, and releasing SDA and SCL lines immediately.

This bit is cleared by writing "0" to it or by reset.

1 = Master mode operation

0 = Slave mode operation

### MRW — Master Read/Write

This bit will be transmitted out as bit 0 of the calling address when the module sets the MAST bit to enter master mode. The MRW bit determines the transfer direction of the data bytes that follows. When it is "1", the module is in master receive mode. When it is "0", the module is in master transmit mode. Reset clears this bit.

1 = Master mode receive

0 = Master mode transmit

### BR2–BR0 — Baud Rate Select

These three bits select one of eight clock rates as the master clock when the module is in master mode.

Since this master clock is derived the CPU bus clock, the user program should not execute the WAIT instruction when the DDC module in master mode. This will cause the SDA and SCL lines to hang, as the WAIT instruction places the MCU in wait mode, with CPU clock is halted. These bits are cleared upon reset. (See [Table 16-2 . Baud Rate Select.](#))

**Table 16-2. Baud Rate Select**

BR2	BR1	BR0	Baud Rate
0	0	0	100k
0	0	1	50k
0	1	0	25k
0	1	1	12.5k
1	0	0	6.25k
1	0	1	3.125k
1	1	0	1.56k
1	1	1	0.78k
NOTE: CPU bus clock is external clock ÷ 4 = 6MHz			

## 16.6.5 DDC Status Register (DDCSR)

Address: \$0019

	Bit 7	6	5	4	3	2	1	Bit 0
Read:	RXIF	TXIF	MATCH	SRW	RXAK	SCLIF	TXBE	RXBF
Write:	0	0				0		
Reset:	0	0	0	0	1	0	1	0

= Unimplemented

**Figure 16-6. DDC Status Register (DDCSR)**

### RXIF — DDC Receive Interrupt Flag

This flag is set after the data receive register (DDCDRR) is loaded with a new received data. Once the DDCDRR is loaded with received data, no more received data can be loaded to the DDCDRR until the CPU reads the data from the DDCDRR to clear RXBF flag. RXIF generates an interrupt request to CPU if the DIEN bit in DDCCR is also set. This bit is cleared by writing "0" to it or by reset; or when the DEN = 0.

- 1 = New data in data receive register (DDCDRR)
- 0 = No data received

### TXIF — DDC Transmit Interrupt Flag

This flag is set when data in the data transmit register (DDCDTR) is downloaded to the output circuit, and that new data can be written to the DDCDTR. TXIF generates an interrupt request to CPU if the DIEN bit in DDCCR is also set. This bit is cleared by writing "0" to it or when the DEN = 0.

- 1 = Data transfer completed
- 0 = Data transfer in progress

### MATCH — DDC Address Match

This flag is set when the received data in the data receive register (DDCDRR) is a calling address which matches with the address or its extended addresses (EXTAD=1) specified in the DDCADR register.

- 1 = Received address matches DDCADR
- 0 = Received address does not match

### SRW — DDC Slave Read/Write

This bit indicates the data direction when the module is in slave mode. It is updated after the calling address is received from a master device. SRW = 1 when the calling master is reading data from the module (slave transmit mode). SRW = 0 when the master is writing data to the module (receive mode).

- 1 = Slave mode transmit
- 0 = Slave mode receive

### RXAK — DDC Receive Acknowledge

When this bit is cleared, it indicates an acknowledge signal has been received after the completion of 8 data bits transmission on the bus. When RXAK is set, it indicates no acknowledge signal has been detected at the 9th clock; the module will release the SDA line for the master to generate "stop" or "repeated start" condition. Reset sets this bit.

- 1 = No acknowledge signal received at 9th clock bit
- 0 = Acknowledge signal received at 9th clock bit

### SCLIF — SCL Interrupt Flag

This flag is set when a falling edge is detected on the SCL line, only if DDC1EN bit is set. SCLIF generates an interrupt request to CPU if the SCLIFEN bit in DDCCR is also set. SCLIF is cleared by writing "0" to it or when the DDC1EN = 0, or DEN = 0. Reset clears this bit.

- 1 = Falling edge detected on SCL line
- 0 = No falling edge detected on SCL line

### TXBE — DDC Transmit Buffer Empty

This flag indicates the status of the data transmit register (DDCDTR). When the CPU writes the data to the DDCDTR, the TXBE flag will be cleared. TXBE is set when DDCDTR is emptied by a transfer of its data to the output circuit. Reset sets this bit.

- 1 = Data transmit register empty
- 0 = Data transmit register full

## RXBF — DDC Receive Buffer Full

This flag indicates the status of the data receive register (DDCDRR). When the CPU reads the data from the DDCDRR, the RXBF flag will be cleared. RXBF is set when DDCDRR is full by a transfer of data from the input circuit to the DDCDRR. Reset clears this bit.

1 = Data receive register full

0 = Data receive register empty

## 16.6.6 DDC Data Transmit Register (DDCDTR)

Address: \$001A

	Bit 7	6	5	4	3	2	1	Bit 0
Read:	DTD7	DTD6	DTD5	DTD4	DTD3	DTD2	DTD1	DTD0
Write:								
Reset:	1	1	1	1	1	1	1	1

**Figure 16-7. DDC Data Transmit Register (DDCDTR)**

When the DDC module is enabled, DEN = 1, data written into this register depends on whether module is in master or slave mode.

In slave mode, the data in DDCDTR will be transferred to the output circuit when:

- the module detects a matched calling address (MATCH = 1), with the calling master requesting data (SRW = 1); or
- the previous data in the output circuit has been transmitted and the receiving master returns an acknowledge bit, indicated by a received acknowledge bit (RXAK = 0).

If the calling master does not return an acknowledge bit (RXAK = 1), the module will release the SDA line for master to generate a "stop" or "repeated start" condition. The data in the DDCDTR will not be transferred to the output circuit until the next calling from a master. The transmit buffer empty flag remains cleared (TXBE = 0).

In master mode, the data in DDCDTR will be transferred to the output circuit when:

- the module receives an acknowledge bit (RXAK = 0), after setting master transmit mode (MRW = 0), and the calling address has been transmitted; or
- the previous data in the output circuit has been transmitted and the receiving slave returns an acknowledge bit, indicated by a received acknowledge bit (RXAK = 0).

If the slave does not return an acknowledge bit (RXAK = 1), the master will generate a "stop" or "repeated start" condition. The data in the DDCDTR will not be transferred to the output circuit. The transmit buffer empty flag remains cleared (TXBE = 0).

The sequence of events for slave transmit and master transmit are illustrated in **Figure 16-9**.

### 16.6.7 DDC Data Receive Register (DDCDRR)

Address: \$001B

	Bit 7	6	5	4	3	2	1	Bit 0
Read:	DRD7	DRD6	DRD5	DRD4	DRD3	DRD2	DRD1	DRD0
Write:								
Reset:	0	0	0	0	0	0	0	0

 = Unimplemented

**Figure 16-8. DDC Data Receive Register (DDCDRR)**

When the DDC module is enabled, DEN = 1, data in this read-only register depends on whether module is in master or slave mode.

In slave mode, the data in DDCDRR is:

- the calling address from the master when the address match flag is set (MATCH = 1); or
- the last data received when MATCH = 0.

In master mode, the data in the DDCDRR is:

- the last data received.

When the DDCCR is read by the CPU, the receive buffer full flag is cleared (RXBF = 0), and the next received data is loaded to the DDCCR. Each time when new data is loaded to the DDCCR, the RXIF interrupt flag is set, indicating that new data is available in DDCCR.

The sequence of events for slave receive and master receive are illustrated in [Figure 16-9](#).

### 16.7 Programming Considerations

When the DDC module detects an arbitration loss in master mode, it will release both SDA and SCL lines immediately. But if there are no further STOP conditions detected, the module will hang up. Therefore, it is recommended to have time-out software to recover from such ill condition. The software can start the time-out counter by looking at the BB (Bus Busy) flag in the DDCMCR and reset the counter on the completion of one byte transmission. If a time-out occur, software can clear the DEN bit (disable DDC module) to release the bus, and hence clearing the BB flag. This is the only way to clear the BB flag by software if the module hangs up due to a no STOP condition received. The DDC can resume operation again by setting the DEN bit.



(a) Master Transmit Mode

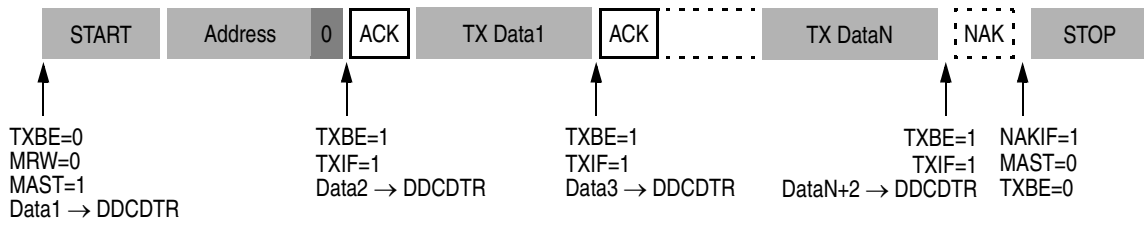

(b) Master Receive Mode

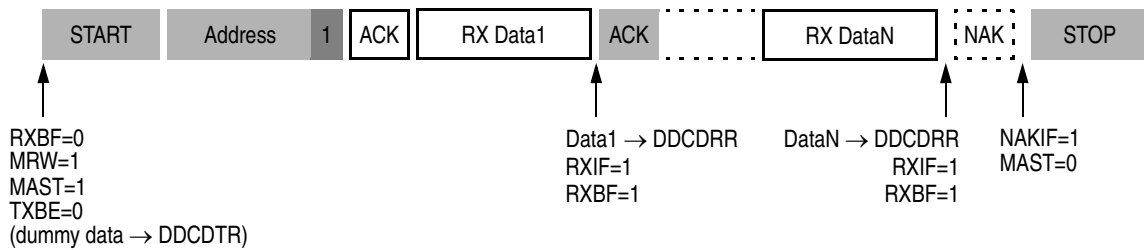

(c) Slave Transmit Mode

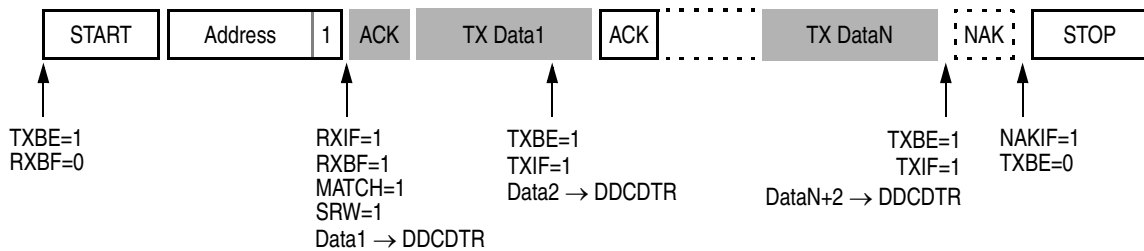

(d) Slave Receive Mode

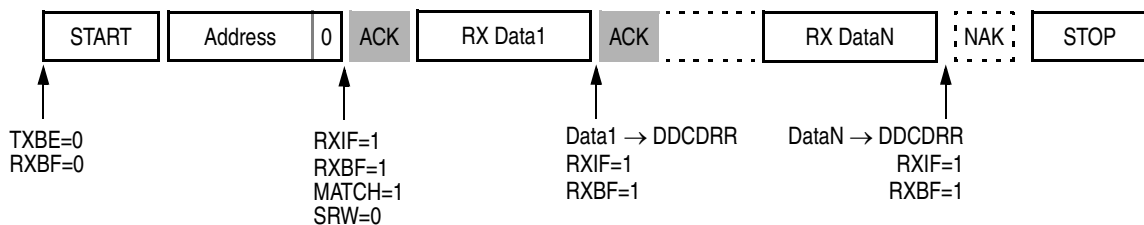

KEY: shaded data packets indicate a transmit by the MCU's DDC module

**Figure 16-9. Data Transfer Sequences for Master/Slave Transmit/Receive Modes**



## Section 17. Sync Processor

### 17.1 Contents

17.2	Introduction	252
17.3	Features	252
17.4	I/O Pins	253
17.5	Functional Blocks	255
17.5.1	Polarity Detection	256
17.5.1.1	Hsync Polarity Detection	256
17.5.1.2	Vsync Polarity Detection	256
17.5.1.3	Composite Sync Polarity Detection	256
17.5.2	Sync Signal Counters	257
17.5.3	Polarity Controlled HOUT and VOUT Outputs	257
17.5.4	Clamp Pulse Output	258
17.5.5	Low Vertical Frequency Detect	259
17.6	Sync Processor I/O Registers	259
17.6.1	Sync Processor Control & Status Register (SPCSR)	259
17.6.2	Sync Processor Input/Output Control Register (SPIOCR)	261
17.6.3	Vertical Frequency Registers (VFRs)	263
17.6.4	Hsync Frequency Registers (HFRs)	265
17.6.5	Sync Processor Control Register 1 (SPCR1)	267
17.6.6	H & V Sync Output Control Register (HVOCR)	268
17.7	System Operation	269

## 17.2 Introduction

The Sync Processor is designed to detect and process sync signals inside a digital monitor system — from separated Hsync and Vsync inputs. After detection and the necessary polarity correction and/or sync separation, the corrected sync signals are sent out. The MCU can also send commands to other monitor circuitry, such as for the geometry correction and OSD, using the DDC12AB and/or the IIC communication channels.

The block diagram of the Sync Processor is shown in [Figure 17-2](#).

**NOTE:** *All quoted timings in this section assume an internal bus frequency of 6MHz.*

## 17.3 Features

Features of the Sync Processor include the following:

- Polarity detector
- Horizontal frequency counter
- Vertical frequency counter
- Low vertical frequency indicator (40.7Hz)
- Polarity controlled HOUT and VOUT outputs:
  - From separate Hsync and Vsync
  - From composite sync on HSYNC input pin
  - From internal selectable free running Hsync and Vsync pulses
- Free-running Hsync, Vsync, DE, and DCLK of 4 video modes
- CLAMP pulse output to the external pre-amp chip
- Internal schmitt trigger on HSYNC, and VSYNC input pins to improve noise immunity

## 17.4 I/O Pins

The Sync Processor uses seven I/O pins, with four pins shared with standard port I/O pins and one pin shared with timer channel 0. The full name of the Sync Processor I/O pins are listed in [Table 17-1](#). The generic pin name appear in the text that follows.

**Table 17-1. Pin Name Conventions**

Sync Processor Generic Pin Names:	Full MCU Pin Names:	Pin Selected for Sync Processor Function By:
HSYNC	HSYNC	—
VSYNC	VSYNC	—
HOUT	PTD3/HOUT	HOUTE bit in PDCR (\$0069)
VOUT	PTD2/VOUT	VOUTE bit in PDCR (\$0069)
DE	PTD1/DE	DEE bit in PDCR (\$0069)
DCLK	PTD0/DCLK	DCLKE bit in PDCR (\$0069)
CLAMP	CLAMP/TCH0	ELS0B and ELS0A bits in TSC0 (\$0010)

# Sync Processor

Addr.	Register Name		Bit 7	6	5	4	3	2	1	Bit 0
\$0040	Sync Processor Control and Status Register (SPCSR)	Read:	VSIE	VEDGE	VSIF	COMP	VINVO	HINVO	VPOL	HPOL
		Write:			0					
		Reset:	0	0	0	0	0	0	0	0
\$0041	Vertical Frequency High Register (VFHR)	Read:	VOF	0	0	VF12	VF11	VF10	VF9	VF8
		Write:		CPW1	CPW0					
		Reset:	0	0	0	0	0	0	0	0
\$0042	Vertical Frequency Low Register (VFLR)	Read:	VF7	VF6	VF5	VF4	VF3	VF2	VF1	VF0
		Write:								
		Reset:	0	0	0	0	0	0	0	0
\$0043	Hsync Frequency High Register (HFHR)	Read:	HFH7	HFH6	HFH5	HFH4	HFH3	HFH2	HFH1	HFH0
		Write:								
		Reset:	0	0	0	0	0	0	0	0
\$0044	Hsync Frequency Low Register (HFLR)	Read:	HOVER	0	0	HFL4	HFL3	HFL2	HFL1	HFL0
		Write:								
		Reset:	0	0	0	0	0	0	0	0
\$0045	Sync Processor I/O Control Register (SPIOCR)	Read:	VSYNCS	HSYNCS	COINV	R	R	R	BPOR	SOUT
		Write:								
		Reset:	0	0	0				0	0
\$0046	Sync Processor Control Register 1 (SPCR1)	Read:	LVSIE	LVSIF	HPS1	HPS0	R	R	ATPOL	FSHF
		Write:		0						
		Reset:	0	0	0	0			0	0
\$003F	H&V Sync Output Control Register (HVOCR)	Read:				DCLKPH1	DCLKPH0	R	HVOCR1	HVOCR0
		Write:								
		Reset:				0	0		0	0

= Unimplemented
  = Reserved

**Figure 17-1. Sync Processor I/O Register Summary**

## 17.5 Functional Blocks

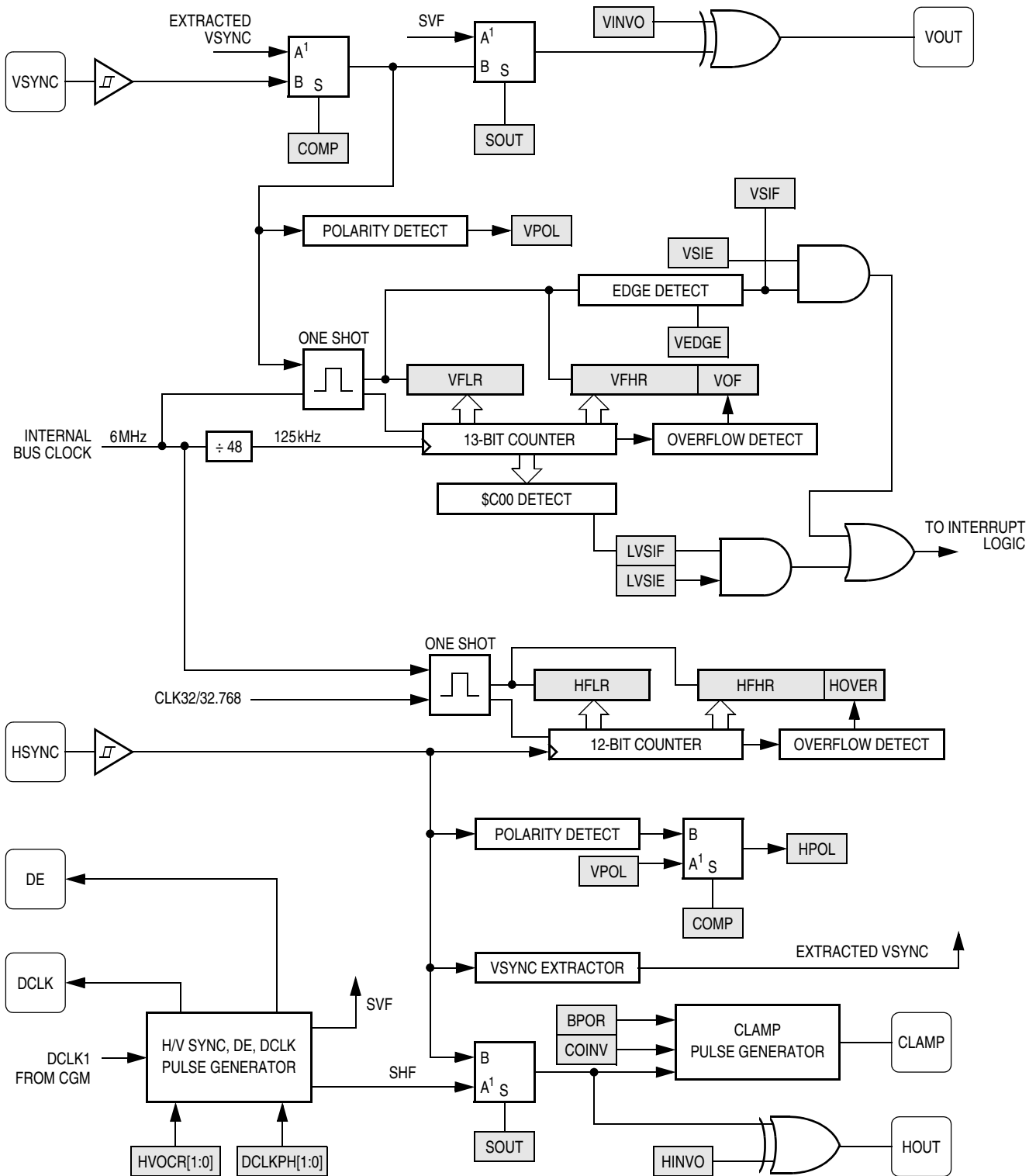

Figure 17-2. Sync Processor Block Diagram

## 17.5.1 Polarity Detection

### 17.5.1.1 Hsync Polarity Detection

The Hsync polarity detection circuit measures the length of high and low period of the HSYNC input. If the length of high is longer than  $L$  and the length of low is shorter than  $S$ , the HPOL bit will be "0", indicating a negative polarity HSYNC input. If the length of low is longer than  $L$  and the length of high is shorter than  $S$ , the HPOL bit will be "1", indicating a positive polarity HSYNC input. The table below shows three possible cases for HSYNC polarity detection — the conditions are selected by the HPS[1:0] bits in the Sync Processor Control Register 1 (SPCR1).

Polarity Detection Pulse Width		SPCR1 (\$0046)	
Long is greater than ( $L$ )	Short is less than ( $S$ )	HPS1	HPS0
7 $\mu$ s	6 $\mu$ s	0	0
3.5 $\mu$ s	3 $\mu$ s	1	X
14 $\mu$ s	12 $\mu$ s	0	1

### 17.5.1.2 Vsync Polarity Detection

The Vsync polarity detection circuit performs a similar function as for Hsync. If the length of high is longer than 4ms and the length of low is shorter than 2ms, the VPOL bit will be "0", indicating a negative polarity VSYNC input. If the length of low is longer than 4ms and the length of high is shorter than 2ms, the VPOL bit will be "1", indicating a positive polarity VSYNC input.

### 17.5.1.3 Composite Sync Polarity Detection

When a composite sync signal is the input (COMP = 1 for composite sync processing), the HPOL bit = VPOL bit, and the polarity is detected using the VSYNC polarity detection criteria described in section [17.5.1.2](#).



## 17.5.2 Sync Signal Counters

There are two counters: a 13-bit horizontal frequency counter to count the number of horizontal sync pulses within a 32ms or 8ms period; and a 13-bit vertical frequency counter to count the number of system clock cycles between two vertical sync pulses. These two data can be read by the CPU to check the signal frequencies and to determine the video mode.

The 13-bit vertical frequency register encompasses vertical frequency range from approximately 15Hz to 128kHz. Due to the asynchronous timing between the incoming VSYNC signal and internal system clock, there will be  $\pm 1$  count error on reading the Vertical Frequency Registers (VFRs) for the same vertical frequency.

The horizontal counter counts the pulses on HSYNC pin input, and is uploaded to the Hsync Frequency Registers (HFRs) every 32.768ms or 8.192ms.

## 17.5.3 Polarity Controlled HOUT and VOUT Outputs

The processed sync signals are output on HOUT and VOUT when the corresponding bits in Configuration Register 0 (\$0069) are set. The signal to these output pins depend on SOUT and COMP bits (see [Table 17-2](#)), with polarity controlled by ATPOL, HINVO, and VINVO bits as shown in [Table 17-3](#).

**Table 17-2. Sync Output Control**

SOUT	COMP	Sync Outputs: VOUT and HOUT
1	X	Free-running video mode output
0	0	Sync outputs follow sync inputs VSYNC and HSYNC respectively, with polarity correction shown in <a href="#">Table 17-3</a> .
0	1	HOUT follows the composite sync input and VOUT is the extracted Vsync (3 to 14 $\mu$ s delay to composite input), with polarity correction shown in <a href="#">Table 17-3</a> .

**Table 17-3. Sync Output Polarity**

ATPOL	SOUT	VINVO or HINVO	Sync Outputs: VOUT/HOUT
X	1	X	Free-running video mode output
0	0	0	Same polarity as sync input
0	0	1	Inverted polarity of sync input
1	0	0	Negative polarity sync output
1	0	1	Positive polarity sync output

When the SOUT bit is set, the HOUT output is a free-running pulse. Both HOUT and VOUT outputs are negative polarity, with frequencies selected by the H & V Sync Output Control Register (HVOCR).

### 17.5.4 Clamp Pulse Output

When the ELS0B and ELS0A bits in the TSC0 register are logic 0 (see [Table 11-3](#)), a clamp signal is output on the CLAMP pin. This clamp pulse is triggered either on the leading edge or the trailing edge of HSYNC, controlled by BPOR bit, with the polarity controlled by the COINV bit. See [Figure 17-3 . Clamp Pulse Output Timing](#).

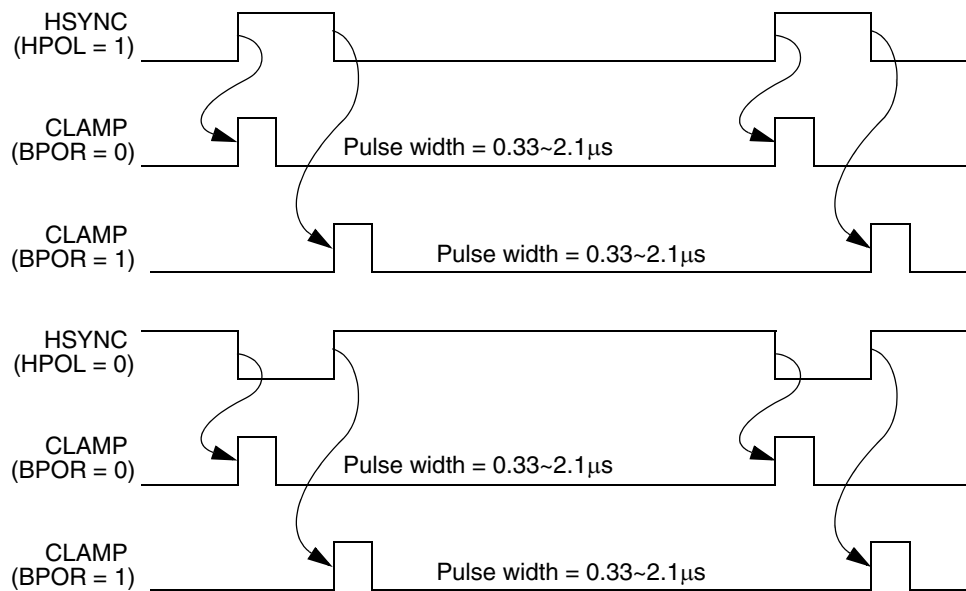

**Figure 17-3. Clamp Pulse Output Timing**

### 17.5.5 Low Vertical Frequency Detect

Logic monitors the value of the Vsync Frequency Register (VFR), and sets the low vertical frequency flag (LVSIF) when the value of VFR is higher than \$C00 (frequency below 40.7Hz). LVSIF bit can generate an interrupt request to the CPU when the LVSIE bit is set and I-bit in the Condition Code Register is "0". The LVSIF bit can help the system to detect video off mode fast.

## 17.6 Sync Processor I/O Registers

Eight registers are associated with the Sync Processor, they outlined in the following sections.

### 17.6.1 Sync Processor Control & Status Register (SPCSR)

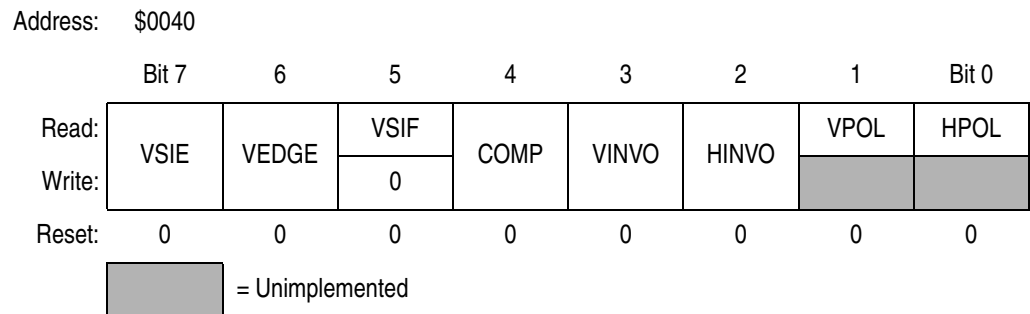

**Figure 17-4. Sync Processor Control & Status Register (SPCSR)**

**VSIE** — VSync Interrupt Enable

When this bit is set, the VSIF flag is enabled to generate an interrupt request to the CPU. When VSIE is cleared, the VSIF flag is prevented from generating an interrupt request to the CPU. Reset clears this bit.

1 = VSIF bit set will generate interrupt request to CPU

0 = VSIF bit set does not generate interrupt request to CPU

## VEDGE — VSync Interrupt Edge Select

This bit specifies the triggering edge of Vsync interrupt. When it is "0", the rising edge of internal Vsync signal which is either from the VSYNC pin or extracted from the composite input signal will set VSIF flag. When it is "1", the falling edge of internal Vsync signal will set VSIF flag. Reset clears this bit.

1 = VSIF bit will be set by falling edge of Vsync

0 = VSIF bit will be set by rising edge of Vsync

## VSIF — VSync Interrupt Flag

This flag is only set by the specified edge of the internal Vsync signal, which is either from the VSYNC input pin or extracted from the composite sync input signal. The triggering edge is specified by the VEDGE bit. VSIF generates an interrupt request to the CPU if the VSIE bit is also set. This bit is cleared by writing a "0" to it or by a reset.

1 = A valid edge is detected on the Vsync

0 = No valid Vsync is detected

## COMP — Composite Sync Input Enable

This bit is set to enable the separator circuit which extracts the Vsync pulse from the composite sync input on HSYNC. The extracted Vsync signal is used as it were from the VSYNC input. Reset clears this bit.

1 = Composite sync input enabled

0 = Composite sync input disabled

## VINVO — VOUT Signal Polarity

This bit, together with the ATPOL bit in SPCR1 controls the output polarity of the VOUT signal (see [Table 17-4](#)).

## HINVO — HOUT Signal Polarity

This bit, together with the ATPOL bit in SPCR1 controls the output polarity of the HOUT signal (see [Table 17-4](#)).

**Table 17-4. ATPOL, VINVO, and HINVO setting**

ATPOL	VINVO / HINVO	Sync Outputs: VOUT/HOUT
0	0	Same polarity as sync input
0	1	Inverted polarity of sync input
1	0	Negative polarity sync output
1	1	Positive polarity sync output

**VPOL — Vsync Input Polarity**

This bit indicates the polarity of the VSYNC input, or the extracted Vsync from a composite sync input (COMP=1). Reset clears this bit.

- 1 = Vsync is positive polarity
- 0 = Vsync is negative polarity

**HPOL — Hsync Input Polarity**

This bit indicates the polarity of the HSYNC input. This bit equals the VPOL bit when the COMP bit is set. Reset clears this bit.

- 1 = Hsync is positive polarity
- 0 = Hsync is negative polarity

**17.6.2 Sync Processor Input/Output Control Register (SPIOCR)**

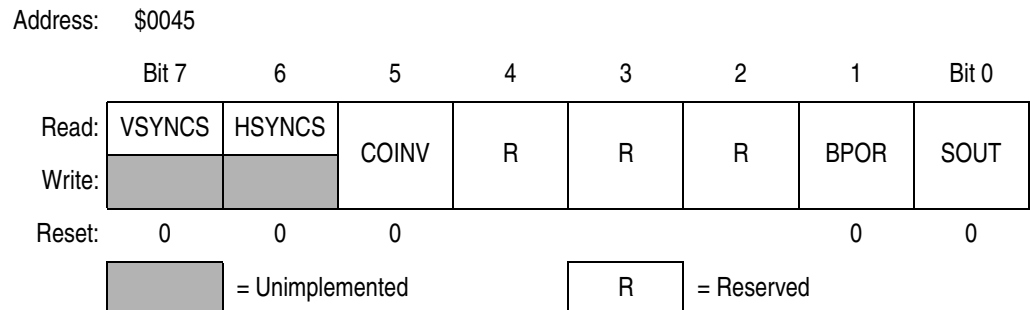

**Figure 17-5. Sync Processor Input/Output Control Register (SPIOCR)**

**VSYNCS — VSYNC Input State**

This read-only bit reflects the logical state of the VSYNC input.

**HSYNCS — HSYNC Input State**

This read-only bit reflects the logical state of the HSYNC input.

## COINV — Clamp Output Invert

This bit is set to invert the clamp pulse output to negative. Reset clears this bit.

1 = Clamp output is set for negative pulses

0 = Clamp output is set for positive pulses

## BPOR — Back Porch

This bit defines the triggering edge of the clamp pulse output relative to the HSYNC input. Reset clears this bit.

1 = Clamp pulse is generated on the trailing edge of HSYNC

0 = Clamp pulse is generated on the leading edge of HSYNC

## SOUT — Sync Output Enable

This bit will select the output signals for the VOUT and HOUT pins and generate the DE and DCLK signals to the pins. Reset clears this bit.

1 = VOUT, HOUT, DE, and DCLK outputs are internally generated free-running timing pulses with frequencies determined by HVCOR[1:0] bits in HVCOR and CGM values.

0 = VOUT and HOUT outputs are processed VSYNC and HSYNC inputs respectively and DE and DCLK are hold as logic low.

### 17.6.3 Vertical Frequency Registers (VFRs)

This register pair contains the 13-bit vertical frequency count value, an overflow bit, and the clamp pulse width selection bits.

Address: \$0041

	Bit 7	6	5	4	3	2	1	Bit 0
Read:	VOF	0	0	VF12	VF11	VF10	VF9	VF8
Write:		CPW1	CPW0					
Reset:	0	0	0	0	0	0	0	0

**Figure 17-6. Vertical Frequency High Register**

Address: \$0042

	Bit 7	6	5	4	3	2	1	Bit 0
Read:	VF7	VF6	VF5	VF4	VF3	VF2	VF1	VF0
Write:								
Reset:	0	0	0	0	0	0	0	0

 = Unimplemented

**Figure 17-7. Vertical Frequency Low Register**

#### VF[12:0] — Vertical Frame Frequency

This read-only 13-bit contains information of the vertical frame frequency. An internal 13-bit counter counts the number of 8 $\mu$ s periods between two Vsync pulses. The most significant 5 bits of the counted value is transferred to the high byte register, and the least significant 8 bits is transferred to an intermediate buffer. When the high byte register is read, the 8-bit counted value stored in the intermediate buffer will be uploaded to the low byte register. Therefore, user program must read the high byte register first, then low byte register in order to get the complete counted value of one vertical frame. If the counter overflows, the overflow flag, VOF, will be set, indicating the counter value stored in the VFRs is meaningless. The data corresponds to the period of one vertical frame. This register can be read to determine if the frame frequency is valid, and to determine the video mode.

The frame frequency is calculated by:

$$\text{Vertical Frame Frequency} = \frac{1}{\text{VFR} \pm 1 \times 48 \times t_{\text{CYC}}}$$

$$= \frac{1}{\text{VFR} \pm 1 \times 8\mu\text{s}}$$

for internal bus clock of 6MHz

**Table 17-5** shows examples for the Vertical Frequency Register, all VFR numbers are in hexadecimal.

**Table 17-5. Sample Vertical Frame Frequencies**

VFR	Max Freq.	Min Freq.	VFR	Max Freq.	Min Freq.
\$02A0	186.20 Hz	185.70 Hz	\$0780	65.10 Hz	65.00 Hz
\$03C0	130.34 Hz	130.07 Hz	\$0823	60.04 Hz	59.98 Hz
\$03C1	130.21 Hz	129.94 Hz	\$0824	60.01 Hz	59.95 Hz
\$03C2	130.07 Hz	129.80 Hz	\$0825	59.98 Hz	59.92 Hz
\$04E2	100.08 Hz	99.92 Hz	\$09C4	50.02 Hz	49.98 Hz
\$04E3	100.00 Hz	99.84 Hz	\$09C5	50.00 Hz	49.96 Hz
\$04E4	99.92 Hz	99.76 Hz	\$09C6	49.98 Hz	49.94 Hz
\$06F9	70.07 Hz	69.99 Hz	\$1FFD	15.266 Hz	15.262 Hz
\$06FA	70.03 Hz	69.95 Hz	\$1FFE	15.264 Hz	15.260 Hz
\$06FB	69.99 Hz	69.91 Hz	\$1FFF	15.262 Hz	15.258 Hz

### VOF — Vertical Frequency Counter Overflow

This read-only bit is set when an overflow has occurred on the 13-bit vertical frequency counter. Reset clears this bit, and will be updated every vertical frame.

An overflow occurs when the period of Vsync frame exceeds 64.768ms (a vertical frame frequency lower than 15.258Hz).

1 = A vertical frequency counter overflow has occurred

0 = No vertical frequency counter overflow has occurred



### CPW[1:0] — Clamp Pulse Width

The CPW1 and CPW0 bits are used to select the output clamp pulse width. Reset clears these bits, selecting a default clamp pulse width between 0.33 $\mu$ s and 0.375 $\mu$ s. These bits always read as Zeros.

**Table 17-6. Clamp Pulse Width**

CPW1	CPW0	Clamp Pulse Width
0	0	0.33 $\mu$ s to 0.375 $\mu$ s
0	1	0.5 $\mu$ s to 0.542 $\mu$ s
1	0	0.75 $\mu$ s to 0.792 $\mu$ s
1	1	2 $\mu$ s to 2.042 $\mu$ s

### 17.6.4 Hsync Frequency Registers (HFRs)

This register pair contains the 13-bit Hsync frequency count value and an overflow bit.

Address: \$0043

	Bit 7	6	5	4	3	2	1	Bit 0
Read:	HFH7	HFH6	HFH5	HFH4	HFH3	HFH2	HFH1	HFH0
Write:								
Reset:	0	0	0	0	0	0	0	0

**Figure 17-8. Hsync Frequency High Register**

Address: \$0044

	Bit 7	6	5	4	3	2	1	Bit 0
Read:	HOVER	0	0	HFL4	HFL3	HFL2	HFL1	HFL0
Write:								
Reset:	0	0	0	0	0	0	0	0

 = Unimplemented

**Figure 17-9. Hsync Frequency Low Register**

## HFH[7:0], HFL[4:0] — Horizontal Line Frequency

This read-only 13-bit contains the number of horizontal lines in a 32ms window. An internal 13-bit counter counts the Hsync pulses within a 32ms window in every 32.768ms period. If the FSHF bit in SPCR1 is set, only the most 11-bits (HFH[7:0] & HFL[4:2]) will be updated by the counter. Thus, providing a Hsync pulse count in a 8ms window in every 8.192ms.

The most significant 8 bits of counted value is transferred to the high byte register, and the least significant 5 bits is transferred to an intermediate buffer. When the high byte register is read, the 5-bit counted value stored in the intermediate buffer will be uploaded to the low byte register. Therefore, user the program must read the high byte register first then low byte register in order to get the complete counted value of Hsync pulses. If the counter overflows, the overflow flag, HOVER, will be set, indicating the number of Hsync pulses in 32ms are more than 8191 ( $2^{13}-1$ ), i.e. a Hsync frequency greater than 256kHz.

For the 32ms window, the HFHR and HFLR are such that the frequency step unit in the 5-bit of HFLR is 0.03125kHz, and the step unit in the 8-bit HFHR is 1kHz. Therefore, the Hsync frequency can be easily calculated by:

$$\text{Hsync Frequency} = [HFH + (HFL \times 0.03125)] \text{ kHz}$$

where: *HFH* is the value of HFH[7:0]

*HFL* is the value of HFL[4:0]

## HOVER — Hsync Frequency Counter Overflow

This read-only bit is set when an overflow has occurred on the 13-bit Hsync frequency counter. Reset clears this bit, and will be updated every count period.

An overflow occurs when the number Hsync pulses exceed 8191, a Hsync frequency greater than 256kHz.

1 = A Hsync frequency counter overflow has occurred

0 = No Hsync frequency counter overflow has occurred

### 17.6.5 Sync Processor Control Register 1 (SPCR1)

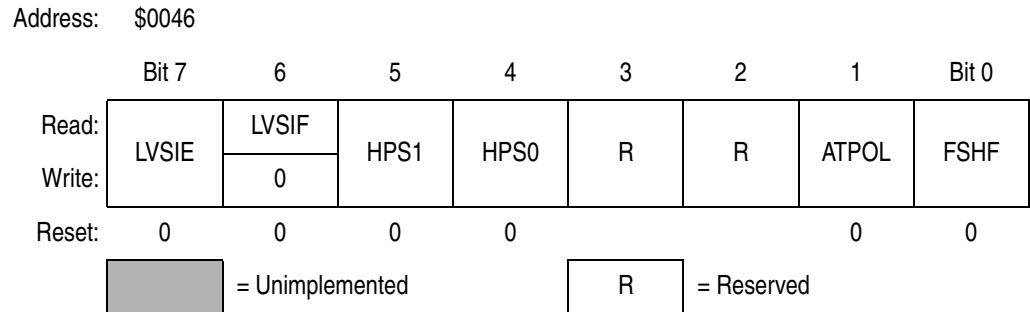

**Figure 17-10. Sync Processor Control Register 1 (SPCR1)**

#### LVSIE — Low VSync Interrupt Enable

When this bit is set, the LVSIF flag is enabled to generate an interrupt request to the CPU. When LVSIE is cleared, the LVSIF flag is prevented from generating an interrupt request to the CPU. Reset clears this bit.

- 1 = Low Vsync interrupt enabled
- 0 = Low Vsync interrupt disabled

#### LVSIF — Low VSync Interrupt Flag

This read-only bit is set when the value of VFR is higher than \$C00 (vertical frame frequency below 40.7Hz). LVSIF generates an interrupt request to the CPU if the LVSIE is also set. This bit is cleared by writing a "0" to it or reset.

- 1 = Vertical frequency is below 40.7Hz
- 0 = Vertical frequency is higher than 40.7Hz

#### HPS[1:0] — HSYNC input Detection Pulse Width

These two bits control the detection pulse width of HSYNC input. Reset clears these two bits, setting a default middle frequency of HSYNC input.

**Table 17-7. HSYNC Polarity Detection Pulse Width**

HPS1	HPS0	Polarity Detection Pulse Width
0	0	Long > 7μs and Short < 6μs
1	X	Long > 3.5μs and Short < 3μs
0	1	Long > 14μs and Short < 12μs

## ATPOL — Auto Polarity

This bit, together with the VINVO or HINVO bits in SPCSR controls the output polarity of the VOUT or HOUT signals respectively. Reset clears this bit (see [Table 17-8](#)).

**Table 17-8. ATPOL, VINVO, and HINVO setting**

ATPOL	VINVO / HINVO	Sync Outputs: VOUT/HOUT
0	0	Same polarity as sync input
0	1	Inverted polarity of sync input
1	0	Negative polarity sync output
1	1	Positive polarity sync output

## FSHF — Fast Horizontal Frequency Count

This bit is set to shorten the measurement cycle of the horizontal frequency. If it is set, only HFH[7:0] and HFL[4:2] will be updated by the Hsync counter, providing a count in a 8ms window in every 8.192ms, with HFL[1:0] reading as zeros. Therefore, user can determine the horizontal frequency change within 8.192ms to protect critical circuitry. Reset clears this bit.

1 = Number of Hsync pulses is counted in an 8ms window

0 = Number of Hsync pulses is counted in a 32ms window

### 17.6.6 H & V Sync Output Control Register (HVOCR)

Address: \$003F

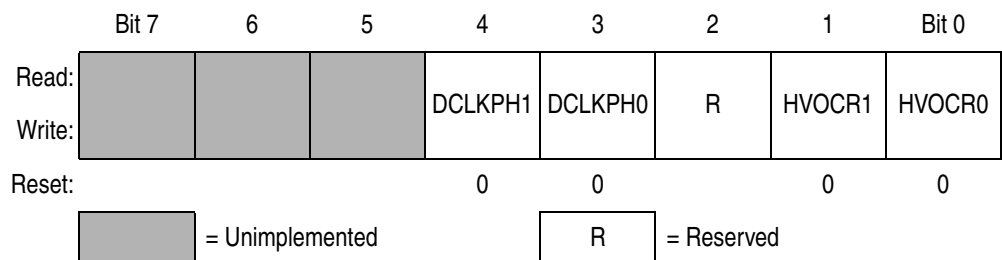

**Figure 17-11. H&V Sync Output Control Register (HVOCR)**

### DCLKPH[1:0] — DCLK Output Phase Adjustment

These two bits are programmed to adjust the DCLK output phase. Each increment adds approximately 2 to 3ns delay to the DCLK output.

### HVOCR[1:0] — Free Running Video Mode Select Bits

These two bits together with MUL[7:4] and VRS[7:4] in CGM's PLL programming register determine the frequencies of the internal generated free-running signals for output to HOUT, VOUT, DE, and DCLK pins, when the SOUT bit is set in the sync processor I/O control register. These two bits determine the prescaler of PLL reference clock in the CGM module. When HVOCR[1:0]=11, the prescaler is 2; for other values, the prescaler is 3. Reset clears these bits, setting a default horizontal frequency of 31.25kHz and a vertical frequency of 60Hz, a video mode of 640×480. (See [Section 8. Clock Generator Module \(CGM\)](#).)

**Table 17-9. Free-Running HSOUT, VSOUT, DE, and DCLK Settings**

HVOCR[1:0]	MUL[7:4]	VRS[7:4]	HOUT Frequency	VOUT Frequency	DCLK Frequency	DE Video Mode
00	3	3	31.45kHz	59.91 Hz	24MHz	VGA 640 × 480
01	5	3	37.87kHz	60.31 Hz	40MHz	SVGA 800 × 600
10	8	6	48.37kHz	60.31 Hz	64MHz	XGA 1024 × 768
11	9	9	64.32kHz	60.00Hz	108MHz	SXGA 1280 × 1024

## 17.7 System Operation

This Sync Processor is designed to assist in determining the video mode of incoming HSYNC and VSYNC of various frequencies and polarities, and DPMS modes. In the DPMS standard, a no sync pulses definition can be detected when the value of the Hsync Frequency Register (the number of Hsync pulses) is less than one or when the VOF bit is set. Since the Hsync Frequency Register is updated repeatedly in every 32.768ms, and a valid Vsync must have a frequency greater than 40.7Hz, a valid Vsync pulse will arrive within the 32.768ms window. Therefore, the user should read the Hsync Frequency Register every 32.768ms to determine the presence of Hsync and/or Vsync pulses.



## Section 18. On-Screen Display (OSD)

### 18.1 Contents

18.2	Introduction	272
18.3	Features	272
18.4	System Overview	273
18.5	OSD FLASH Font Memory Map	275
18.6	OSD Screen Memory Map	276
18.7	OSD Module I/O Registers	277
18.7.1	OSD Control Register (OSDCR)	277
18.7.2	OSD Status Register (OSDSR)	278
18.7.3	OSD Data Registers (OSDDRH:OSDDRL)	279
18.7.4	OSD Row Address Register (OSDRAR)	280
18.7.5	OSD Column Address Register (OSDCAR)	280
18.7.6	OSD FLASH Even High Byte Write Buffer (OSDEHBUF)	281
18.8	OSD Registers	282
18.8.1	OSD Display Registers (Attribute and Code Registers)	282
18.8.2	Row Attribute Registers	283
18.8.3	Control, Window, and Pattern Registers	283
18.8.3.1	Window Registers 1, 2, 3, 4	284
18.8.3.2	Vertical Delay Control Register	285
18.8.3.3	Horizontal Delay Control Register	286
18.8.3.4	Character Height Control Register	286
18.8.3.5	Frame Control Registers	288

## 18.2 Introduction

This section describes the on-screen display (OSD) module. This module includes a 15 row × 30 column display window and video pattern generator.

## 18.3 Features

Features of the on-screen display module include:

- Up to 384 fonts: 12 × 16 or 16 × 16
- Resolution: up to 2048 dots/line
- Scan lines per frame: up to 2048 lines
- Fully programmable display character array of 15 rows by 30 columns
- Eight selections of color for menu windows and fonts
- Row to row spacing control
- Four programmable background windows
- Window shadowing with programmable width, height, and color
- Programmable vertical and horizontal positioning for display center
- Full screen pattern output of free-running VGA, SVGA, XGA, SXGA timing from Sync Processor module
- Double character height and double character width



Addr.	Register Name	Bit 7	6	5	4	3	2	1	Bit 0	
\$0060	OSD Control Register (OSDCR)	Read:	OSDMEN	R	OSDRST	CLKINV	CLKPH1	CLKPH0	HALFCLK	OSDIEN
		Write:								
		Reset:	0		0	0	0	0	0	0
\$0061	OSD Status Register (OSDSR)	Read:	WRDY							DENDIF
		Write:								0
		Reset:	1							0
\$0062	OSD Data Register Low (OSDDRL)	Read:	OSDD7	OSDD6	OSDD5	OSDD4	OSDD3	OSDD2	OSDD1	OSDD0
		Write:								
		Reset:	Unaffected by reset							
\$0063	OSD Data Register High (OSDDRH)	Read:	OSDD15	OSDD14	OSDD13	OSDD12	OSDD11	OSDD10	OSDD9	OSDD8
		Write:								
		Reset:	Unaffected by reset							
\$0064	OSD Row Address Register (OSDRAR)	Read:					ROWA3	ROWA2	ROWA1	ROWA0
		Write:								
		Reset:					0	0	0	0
\$0065	OSD Column Address Register (OSDCAR)	Read:				COLA4	COLA3	COLA2	COLA1	COLA0
		Write:								
		Reset:				0	0	0	0	0
\$0066	OSD FLASH Even High Byte Write Buffer (OSDEHBUF)	Read:	DOT15	DOT14	DOT13	DOT12	DOT11	DOT10	DOT9	DOT8
		Write:								
		Reset:	Unaffected by reset							

 = Unimplemented       = Reserved

**Figure 18-1. On-Screen Display I/O Register Summary**

## 18.4 System Overview

The OSD module has a full screen memory architecture. Refresh is done by the built-in synchronous circuitry. The full screen display data can be updated through writing row, column, and data buffers. Thus, the display data can be updated randomly afterward.

**Figure 18-2** shows the block diagram of the OSD module.

# On-Screen Display (OSD)

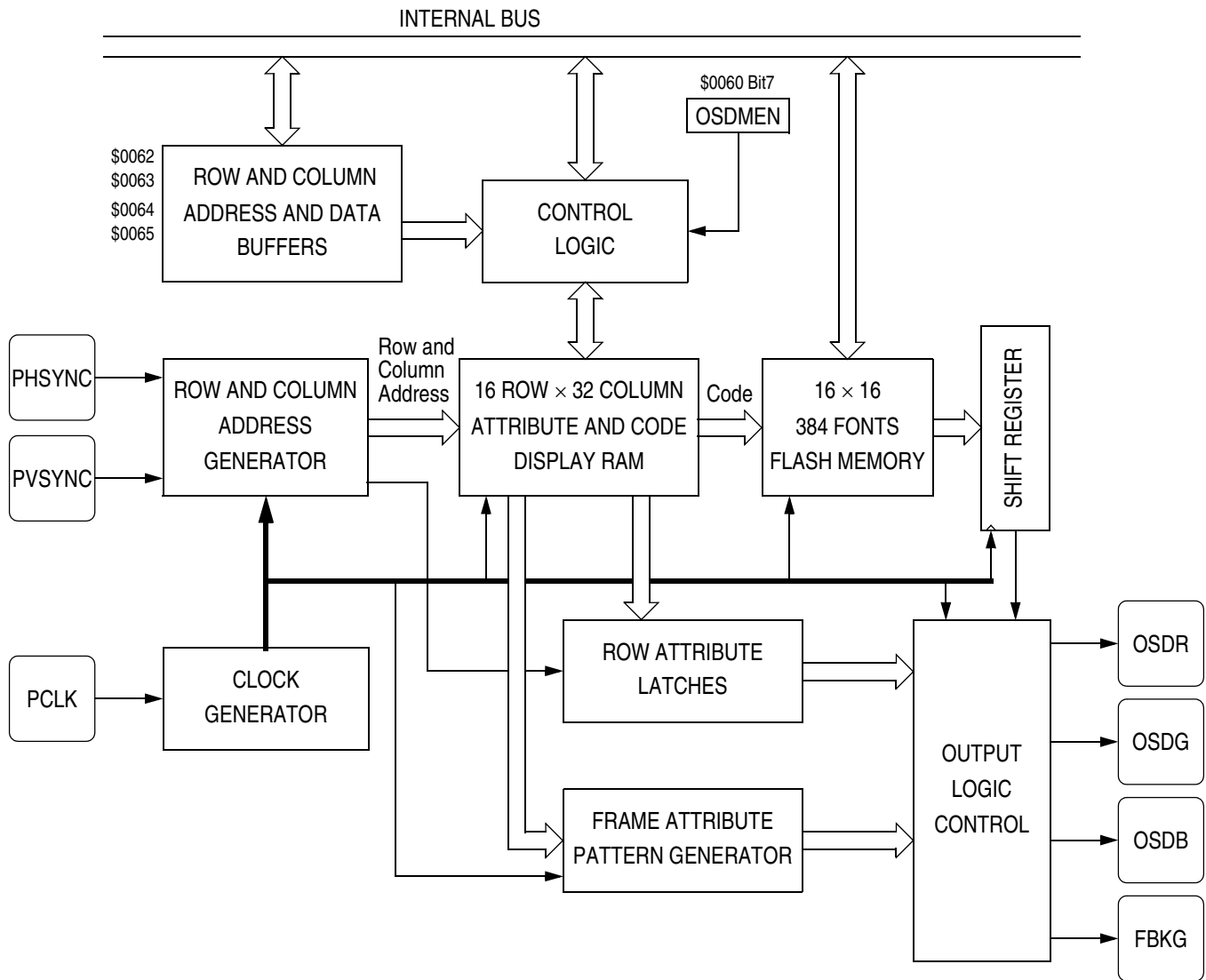

**Figure 18-2. OSD Block Diagram**

User program must write the row and column addresses to the row and column address registers, then write the code and attributes to the 16-bit OSD data register to complete one display character or symbol update. The WRDY bit will then be set to acknowledge that the data has been updated to the addressed display RAM. This process is repeated for other updates.

## 18.5 OSD FLASH Font Memory Map

The 12K-byte FLASH memory from \$1000 to \$3FFF is for OSD font storage. This OSD font memory stores up to 384 fonts, with each font made up of 16 lines by 16 bits, i.e. 32 memory locations. The OSD fonts memory can be accessed by CPU when the OSDMEN bit in the OSD control register is clear. See [18.7.6 OSD FLASH Even High Byte Write Buffer \(OSDEHBUF\)](#) for how to program the OSD font memory.

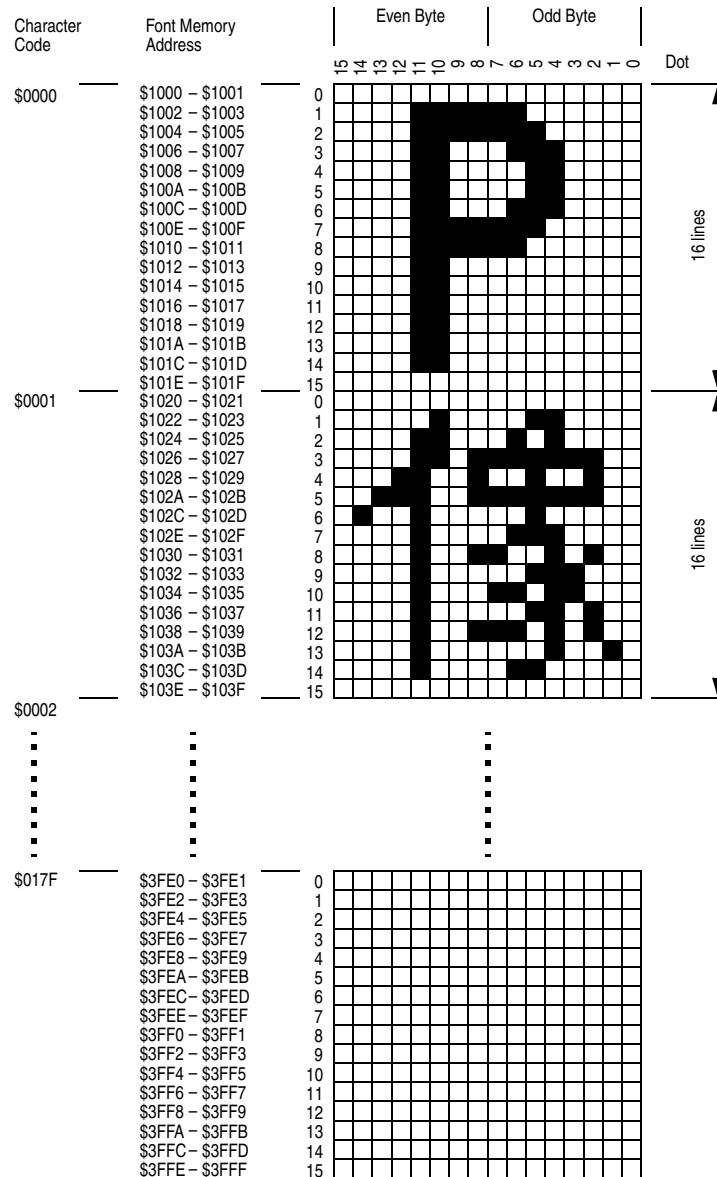
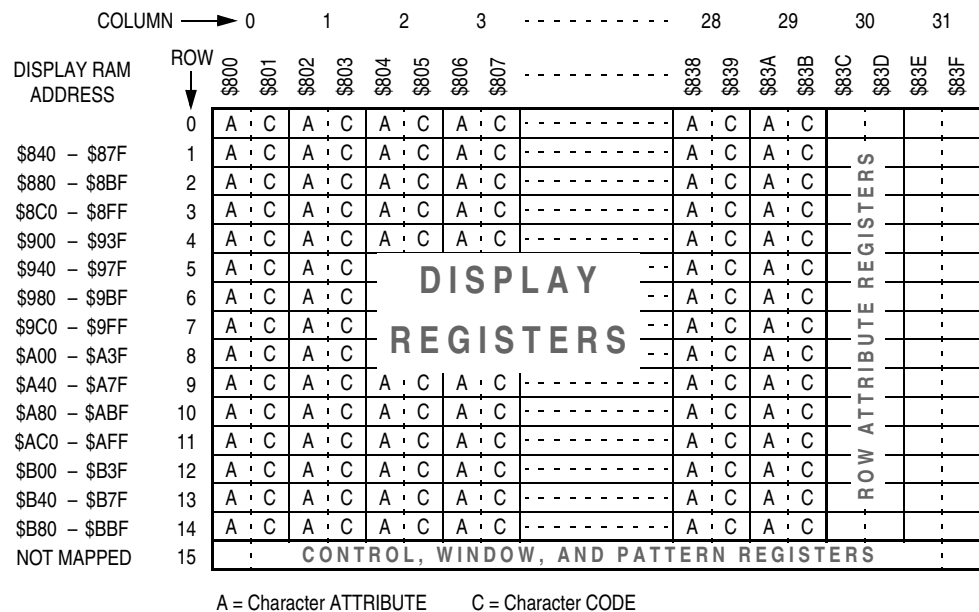

Figure 18-3. Memory Map of OSD FLASH Fonts

## 18.6 OSD Screen Memory Map

The OSD operating screen is mapped to a 1K-byte RAM array from \$0800 to \$0BFF. The array is organized as 16 rows by 32 columns, with two bytes (16-bit) for each row-column location. **Figure 18-4** shows the OSD screen memory map.



**Figure 18-4. Memory Map of OSD Registers**

The area covering row0-column0 and row14-column29 are called the active display registers. Each 16-bit display register defines the character to be displayed, with an character code (character from font memory) and an attribute code for that character. Column30 of each row is the attribute register for the entire row. Row15 registers (not memory mapped) are used for control, window, and pattern for the entire OSD screen. See **18.8 OSD Registers** for register definitions.

The CPU have direct access to the all screen memory registers (\$0800 to \$0BFF) when the OSDMEN bit in the OSD control register is clear. When the OSD circuitry is displaying the characters (OSDMEN=1), updates to display is by indirectly writing to these registers. The OSD data registers, row register, column register are used for this purpose. See **18.7.3 OSD Data Registers (OSDDRH:OSDDL)**, **18.7.4 OSD Row Address Register (OSDRAR)**, and **18.7.5 OSD Column Address Register (OSDCAR)**.

## 18.7 OSD Module I/O Registers

Seven registers are associated with the OSD module, they outlined in the following sections.

### 18.7.1 OSD Control Register (OSDCR)

Address: \$0060

	Bit 7	6	5	4	3	2	1	0
Read:	OSDMEN	R	OSDRST	CLKINV	CLKPH1	CLKPH0	HALFCLK	OSDIEN
Write:								
Reset:	0		0	0	0	0	0	0

**Figure 18-5. OSD Control Register (OSDCR)**

#### OSDMEN — OSD Memory Enable

When this bit is clear, the OSD RAM and font FLASH memory is directly under CPU access. When OSDMEN is set, OSD circuitry has read control over the OSD RAM and font FLASH memory for displaying the contents; CPU access is indirect, by writing to address and data buffers. The OSDMEN bit should be cleared while no OSD are displaying. Reset clear this bit.

- 1 = OSD RAM and font FLASH is under OSD circuitry access
- 0 = OSD RAM and font FLASH is directly under CPU access

#### OSDRST — OSD Module Reset

Setting this bit resets the entire OSD logic and row15 registers (row1 to row14 registers are unaffected), and holds the OSD in the reset state. The input PCLK clock is prevented from entering the OSD module to reduce power consumption.

Reset clear this bit.

- 1 = Reset OSD logic and row15 registers
- 0 = No effect

#### CLKINV — Pixel Clock Inversion

This bit is set to invert the PCLK input of OSD. Reset clears this bit.

- 1 = PCLK input inverted
- 0 = PCLK input not inverted

## CLKPH[1:0] — Pixel Clock Phase Adjustment

These two bits adjust the pixel clock phase to the OSD module. Thus the OSDR, OSDG, and OSDB outputs can be in phase with video signals. Reset clears all these bits.

## HALFCLK — Half Frequency of Pixel Clock

This bit is set to divide the incoming pixel clock by two as the OSD display clock. Reset clears this bit.

1 = OSD module display clock is PCLK divided-by-2

0 = OSD module display clock is PCLK divided-by-1

## OSDIEN — OSD Interrupt Enable

This bit enable OSD interrupt when DENDIF in the OSD status register is set. Reset clear this bit.

1 = DENDIF bit set will generate interrupt request to CPU

0 = DENDIF bit set will not generate interrupt request to CPU

## 18.7.2 OSD Status Register (OSDSR)

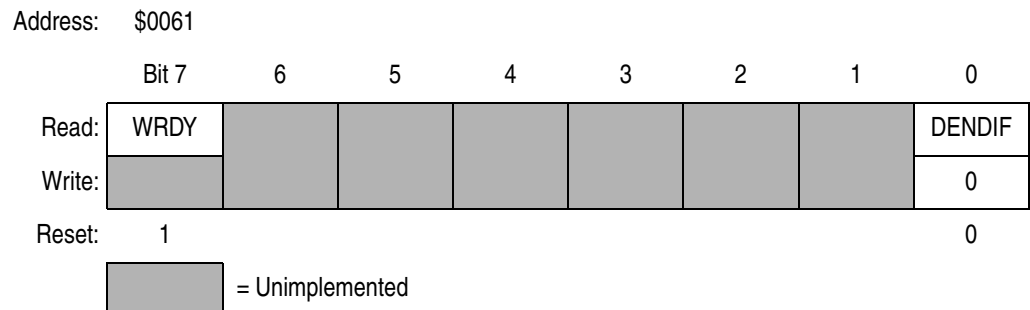

**Figure 18-6. OSD Status Register (OSDSR)**

## WRDY — OSD Buffer Write Ready

This bit is set when the OSD data registers, \$0062 and \$0063, are ready to be loaded with new data. The WRDY is cleared after the CPU writes to the low byte register, \$0062. It becomes set again when the OSD circuitry has transferred the content of data registers to the display RAM. Reset sets this bit.

1 = OSD data buffers ready for new data

0 = OSD data buffers busy

### DENDIF — OSD Display End Interrupt Flag

This bit is set when the OSD has finished the row15 display; it is cleared by writing a logic 0 to it. The DENDIF bit is designed for user program to update the OSD RAM while not displaying OSD. Reset clears this bit.

- 1 = OSD has finished the row15 display
- 0 = No effect

### 18.7.3 OSD Data Registers (OSDDRH:OSDDRL)

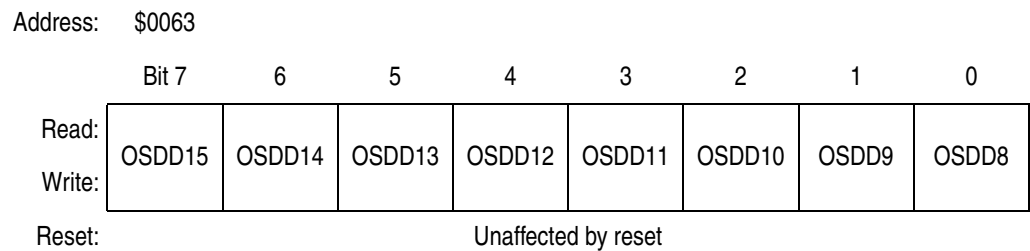

**Figure 18-7. OSD Data Register High (OSDDRH)**

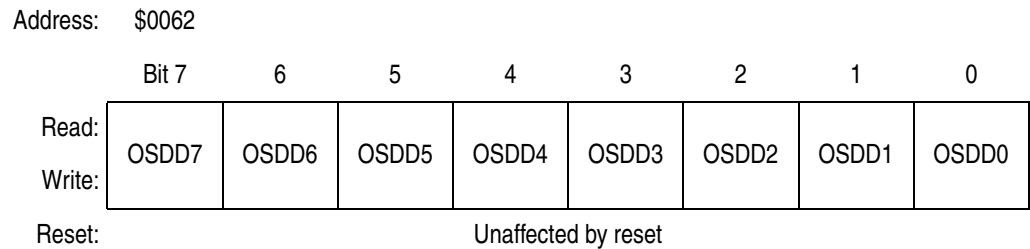

**Figure 18-8. OSD Data Register Low (OSDDRL)**

### OSDD[15:0] — OSD RAM 16-Bit Data Buffer

While OSD circuitry is displaying data from the display RAM, update the display RAM (location specified by the row and column address registers, OSDRAR and OSDCAR) by writing data to the high byte register (OSDDRH) followed by the low byte register (OSDDRL). After writing to the OSDDRL, the OSD buffer write ready bit (WRDY) will be cleared. WRDY becomes set again when the OSD circuitry has transferred the content of the OSD data registers to the display RAM.

Reset has no effect on these bits.

(See [18.6 OSD Screen Memory Map](#).)

## 18.7.4 OSD Row Address Register (OSDRAR)

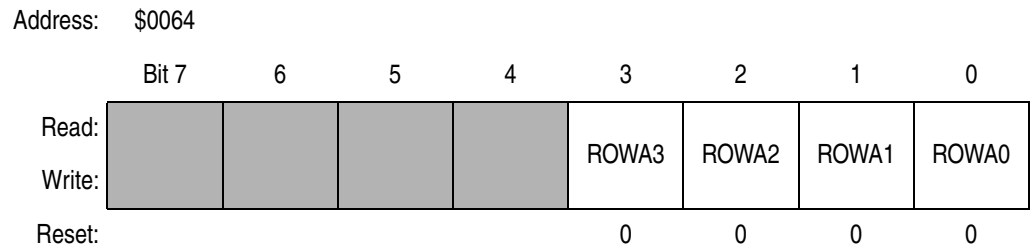

**Figure 18-9. OSD Row Address Register (OSDRAR)**

### ROWA[3:0] — OSD RAM Row Address

These bits define the row address of the OSD RAM. Together with the column address, the row-column address defines the location in the OSD screen memory where data is to be transferred from the data buffers (OSD data registers). Data is transferred when the high byte data register is written (\$0063). Reset clears these bits to zero.

(See [18.6 OSD Screen Memory Map](#).)

## 18.7.5 OSD Column Address Register (OSDCAR)

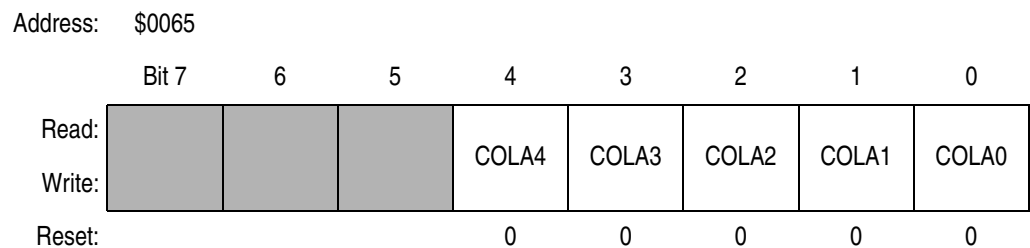

**Figure 18-10. OSD Column Address Register (OSDCAR)**

### COLA[4:0] — OSD RAM Column Address

These bits define the column address of the OSD RAM. Together with the row address, the row-column address defines the location in the OSD screen memory where data is to be transferred from the data buffers (OSD data registers). Data is transferred when the high byte data register is written (\$0063). Reset clears these bits to zero.

(See [18.6 OSD Screen Memory Map](#).)



### 18.7.6 OSD FLASH Even High Byte Write Buffer (OSDEHBUF)

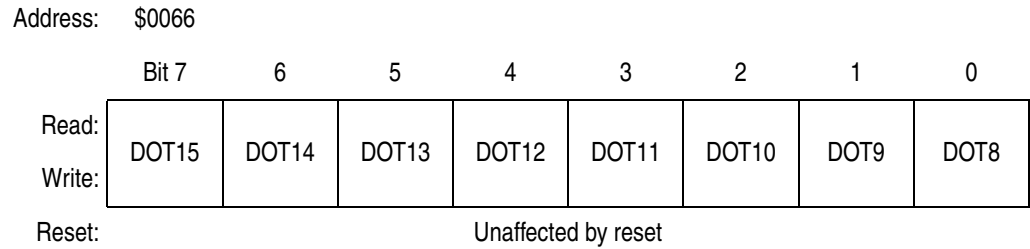

**Figure 18-11. OSD FLASH Even High Byte Write Buffer (OSDEHBUF)**

#### DOT[15:8] — OSD FLASH Even High Byte Buffer

These bits define the even byte for a single line of OSD font, to be programmed to the OSD FLASH memory. Reset has no effect on these bits. [Figure 18-12](#) shows an example of an OSD font.

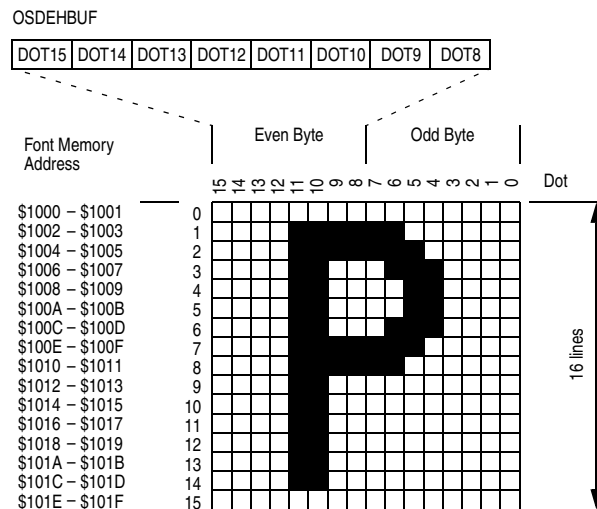

**Figure 18-12. OSD Font Even Byte Buffer**

The OSDEHBUF register is a buffer for temporarily storing the even byte (or high byte) of an OSD font line to be programmed to the OSD FLASH memory. A 16-bit OSD font line is programmed by writing the even byte to OSDEHBUF, followed by a FLASH programming routine to the odd byte in the font memory. Programming the odd byte will automatic program the even byte. See [18.5 OSD FLASH Font Memory Map](#) for OSD font memory map and [Section 4. FLASH Memory](#) on FLASH programming.

## 18.8 OSD Registers

The following sections define the OSD registers for display control as illustrated in [Figure 18-4 . Memory Map of OSD Registers](#).

### 18.8.1 OSD Display Registers (Attribute and Code Registers)

The OSD active display registers consist of 450 attribute and code registers in a 15 row by 30 column matrix. These registers are memory mapped to RAM locations as illustrated in [Figure 18-4](#).

When OSDMEN=0 (not displaying), CPU has direct access to these registers by reading/writing the RAM locations. When OSDMEN=1 (displaying), CPU access these registers indirectly by writing to the OSD data registers, row register and column register.

Each attribute and code register affects one display character.

#### Row 0–14, Column 0–29:

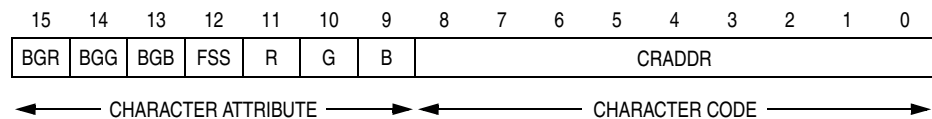

#### CRADDR — Character Address

These bits form an address to select one of the 384 characters/symbols available from the FLASH font memory.

#### BGR, BGG, BGB — Character Background Color

These bits define the color of the background of the associated character/symbol. When all three bits are clear, no background will be shown. Therefore, seven background colors can be selected.

#### FSS — Font Size

This bit will determine the font size of the associated character/symbol. Reset clears this bit.

1 = The font size is 12 × 16 (DOT13 to DOT2)

0 = The font size is 16 × 16

#### R, G, B — Character Color

These bits define the color of the associated character/symbol.

## 18.8.2 Row Attribute Registers

The 15 row attribute registers are at column 30 of the display rows. These registers are memory mapped to RAM locations as illustrated in [Figure 18-4](#).

When OSDMEN=0 (not displaying), CPU has direct access to these registers by reading/writing the RAM locations. When OSDMEN=1 (displaying), CPU access these registers indirectly by writing to the OSD data registers, row register and column register.

Each row attribute register affects characters of a display row.

### Row 0–14, Column 30:

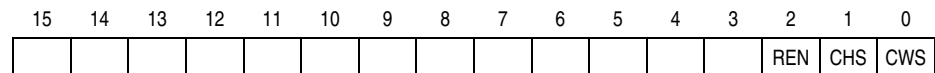

#### REN — Row Enable

Set this bit to enable OSD circuitry to display the current row of characters. This bit should be cleared when display RAM is accessed directly by the CPU and when the row points to a font that is to be updated in the FLASH font memory.

- 1 = Enable display for this row
- 0 = Disable display for this row

#### CHS — Character Height

Set this bit to display double height characters for this row.

- 1 = Display characters as double height for this row
- 0 = Display characters as normal height for this row

#### CWS — Character Width

Set this bit to display double width characters for this row.

- 1 = Display characters as double width for this row
- 0 = Display characters as normal width for this row

## 18.8.3 Control, Window, and Pattern Registers

Row-15 registers are for window, pattern, and miscellaneous control of the entire OSD screen. These registers are NOT memory mapped to RAM locations. CPU access these registers by writing to the OSD data registers, row register and column register.

# On-Screen Display (OSD)

## 18.8.3.1 Window Registers 1, 2, 3, 4

Four background windows are available, with each window controlled by a set of three registers in row 15.

Window 1 has the highest priority, and window 4 the least. If window over-lapping occurs, the higher priority window will cover the lower one, and the higher priority color will take over on the overlapped window area.

If the row/column start address is greater than the end address, that window will not be displayed.

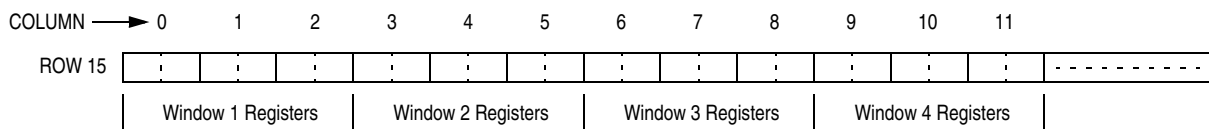

### Row 15, Column 0, 3, 6, 9:

15	14	13	12	11	10	9	8	7	6	5	4	3	2	1	0
								ROW START ADDRESS			ROW END ADDRESS				
								MSB			LSB		MSB		LSB

### Row 15, Column 1, 4, 7, 10:

15	14	13	12	11	10	9	8	7	6	5	4	3	2	1	0
								COLUMN START ADDRESS				WEN	W_SHD		
								MSB						LSB	

### Row 15, Column 2, 5, 6, 11:

15	14	13	12	11	10	9	8	7	6	5	4	3	2	1	0
								COLUMN END ADDRESS				R	G	B	
								MSB							LSB

### WEN — Background Window Enable

Set this bit to enable background window generation

1 = Enable background window

0 = Disable background window

### W\_SHD — Shadow on Window

Set this bit to activate the window shadowing. When the window is active, the right M pixels and lower N horizontal scan lines will output shadowing. The M, N, and color of window shadow is defined in the frame control registers located at row 15, column 16, 17, 18, and 19. See [18.8.3.5 Frame Control Registers](#) for details.

- 1 = Background window shadow enabled
- 0 = Background window shadow disabled

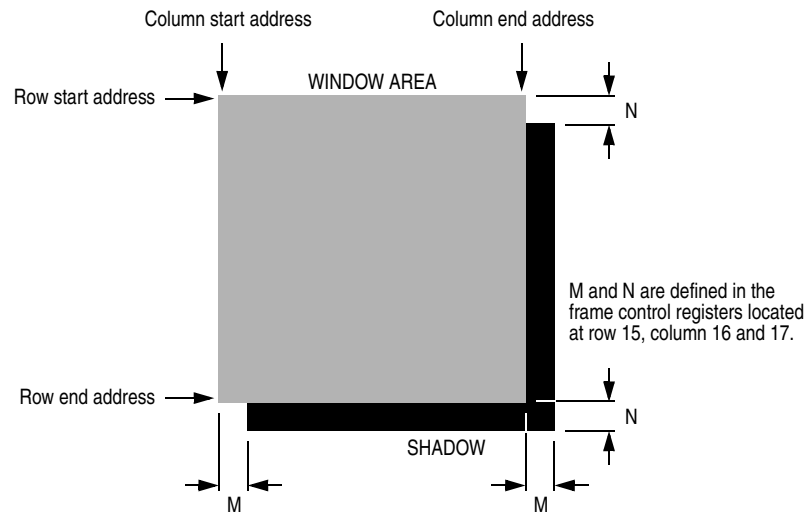

### R, G, B — Background Window Color

These bits define the color of the background window.

#### 18.8.3.2 Vertical Delay Control Register

##### Row 15, Column 12:

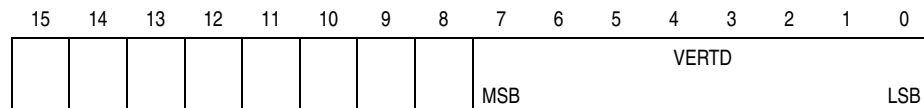

### VERTD — Vertical Delay

These bits define the vertical starting position. The 8-bit gives 256 steps, with each step increment of four horizontal lines for each field. Its value cannot be zero at anytime. In order to avoid screen misalignment, the value of VERTD is decided by the last OSD line not over the next leading edge of PVSYNC.

## 18.8.3.3 Horizontal Delay Control Register

### Row 15, Column 13:

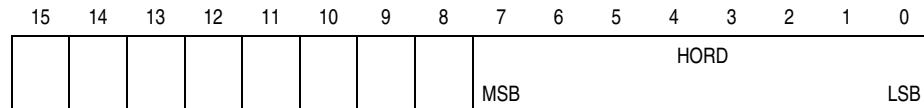

### HORD — Horizontal Delay

These bits define the horizontal starting position for character display. The 8-bit gives 256 steps, with each step increment of six dots shift to the right on the monitor screen. The maximum value of HORD is decided by the rightmost character not exceeding the next leading edge of PHSYNC.

## 18.8.3.4 Character Height Control Register

This register controls the height of all displayed characters.

### Row 15, Column 14:

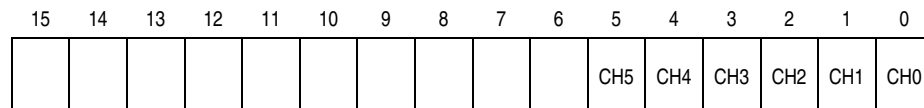

### CH[3:0] — Expand Characters by BRM Algorithm

These bits expand the 16-line characters using the binary rate multiplier (BRM) algorithm. See [Figure 18-13](#) for some examples.

### CH[5:4] — Display Character Height Select

These two bits define the final height for the display characters. See [Figure 18-14](#) for illustration.

CH5:CH4	Character Display Size
00 or 01	Display size is same size as expanded font by CH[3:0]. The default value is 00.
10	Display size is double size of expanded font by CH[3:0].
11	Display size is triple size of expanded font by CH[3:0].

**NOTE:** To avoid undesirable on-screen displays, such as jittering and characters wrapping to the top, care should be taken when implementing character height expansion and vertical starting position — ensure the last line of row14 does not exceed the PVSYNC pulse of the next frame.

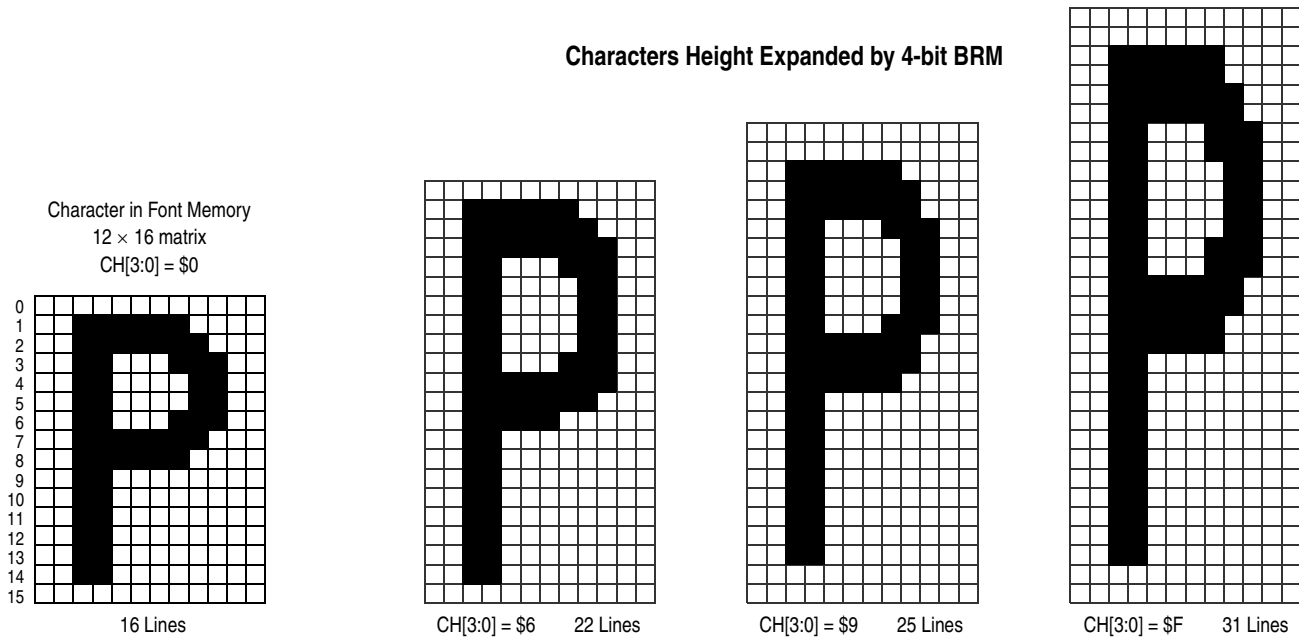

**Figure 18-13. Character Font Matrix Height Expansion by CH[3:0]**

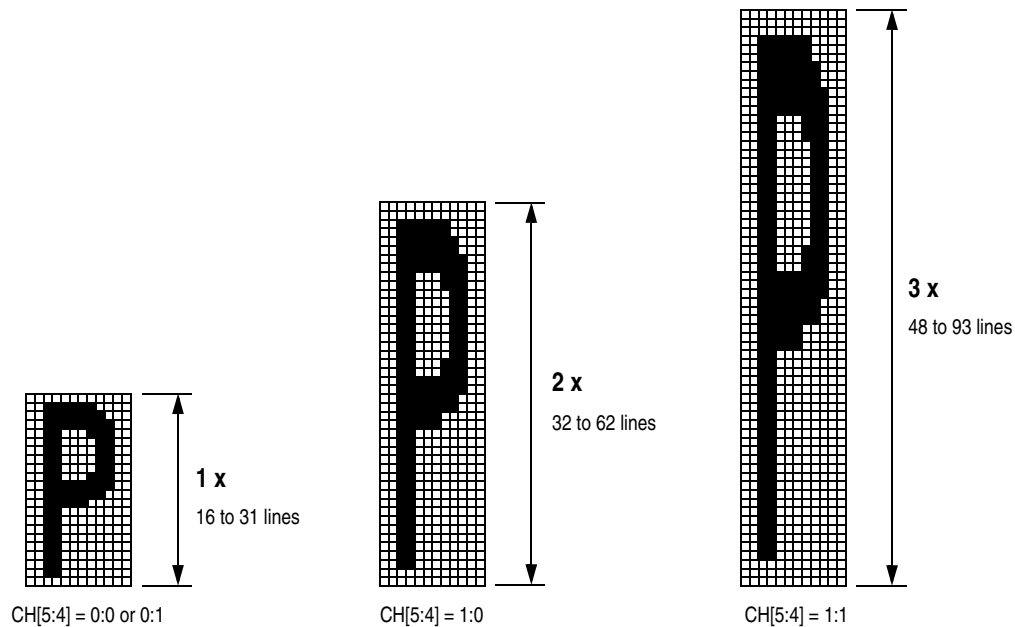

**Figure 18-14. Display Character Height**

## 18.8.3.5 Frame Control Registers

### Row 15, Column 15:

15	14	13	12	11	10	9	8	7	6	5	4	3	2	1	0
								OSD_EN						VPOL	HPOL

#### OSD\_EN — OSD Enable

Set this bit to enable the OSD module output pins, OSDR, OSDG, OSDB, and FBKG. When OSD\_EN is clear, all OSD output pins are high impedance. This bit is cleared after a POR, reset, or when OSDRST bit (bit-5 in OSD control register) is set.

- 1 = OSD output pins: OSDR, OSDG, OSDB, FBKG enabled
- 0 = OSD output pins held at high impedance

#### HPOL — Horizontal Sync Polarity

This bit selects the polarity of the incoming horizontal sync signal on PHSYNC pin. If sync signal is negative polarity, clear this bit. If sync signal is positive polarity, set this bit. This bit is cleared after a POR, reset, or when OSDRST bit is set.

- 1 = Set for positive horizontal sync signal
- 0 = Clear for negative horizontal sync

#### VPOL — Vertical Sync Polarity

This bit selects the polarity of the incoming vertical sync signal on PVSYNC pin. If sync signal is negative polarity, clear this bit. If sync signal is positive polarity, set this bit. This bit is cleared after a POR, reset, or when OSDRST bit is set.

- 1 = Set for positive vertical sync signal
- 0 = Clear for negative vertical sync



Row 15, Column 16 and 17 registers control the width and height of the shadow windows.

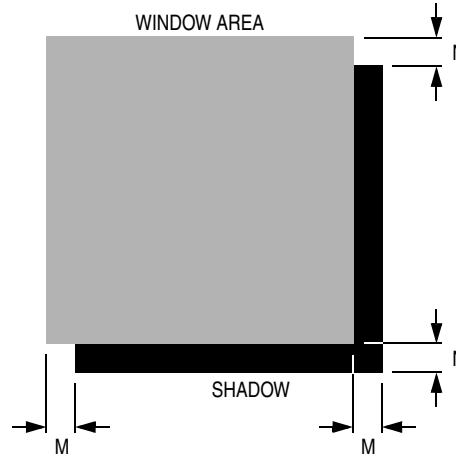

**Row 15, Column 16:**

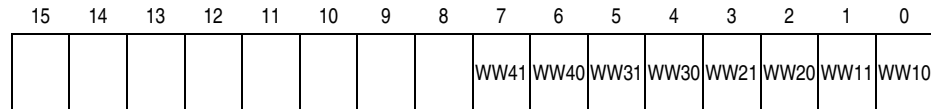

**WWx1, WWx0 — Shadow Window Width Control Bits**

These bits selects the width, M, for the respective enabled shadow window; where x is the window number.

**Table 18-1. Shadow Width Setting**

WWx1:WWx0	Shadow Width M (unit in Pixels)
00	2
01	4
10	6
11	8

## Row 15, Column 17:

15	14	13	12	11	10	9	8	7	6	5	4	3	2	1	0
								WH41	WH40	WH31	WH30	WH21	WH20	WH11	WH10

## WHx1, WHx0 — Shadow Window Height Control Bits

These bits selects the width, N, for the respective enabled shadow window; where x is the window number.

**Table 18-2. Shadow Width Setting**

WH41:WH40	Shadow Height N (unit in Lines)
00	2
01	4
10	6
11	8

Row 15, Column 18 and 19 registers control the color of the shadow windows.

## Row 15, Column 18:

15	14	13	12	11	10	9	8	7	6	5	4	3	2	1	0
									R <sub>1</sub>	G <sub>1</sub>	B <sub>1</sub>		R <sub>2</sub>	G <sub>2</sub>	B <sub>2</sub>

## Row 15, Column 19:

15	14	13	12	11	10	9	8	7	6	5	4	3	2	1	0
									R <sub>3</sub>	G <sub>3</sub>	B <sub>3</sub>		R <sub>4</sub>	G <sub>4</sub>	B <sub>4</sub>

## R<sub>x</sub>, G<sub>x</sub>, B<sub>x</sub> — Shadow Window Color

These bits define the color of the corresponding shadow window; where x is the window number

**NOTE:** The width of bottom side shadowing is counted in numbers of columns and is aligned with the character width (12 dots or 16 dots) of the following row. Therefore it is possible to have misalignment of this shadowing while different character formats are used by the last row inside the window and first row outside the window. The window shadowing width of row 14 is determined by number of columns of window times 12 dots.

**Row 15, Column 20:**

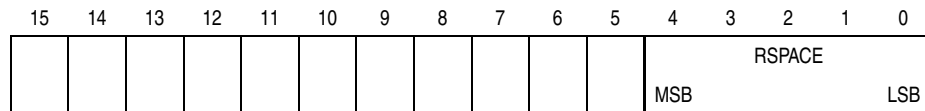

**RSPACE — Row Spacing**

These bits define the spacing between the display rows, in units of horizontal scan lines. Due to the non-uniform expansion of the BRM algorithm used for character height control, this register is normally used for maintaining a constant OSD menu height for different display modes, instead of adjusting the character heights. The default value is 0, i.e. no extra lines inserted between.

**Row 15, Column 21:**

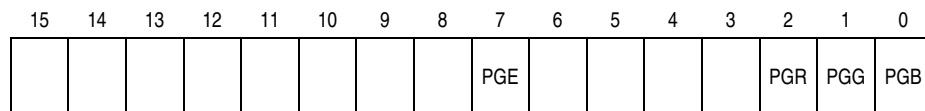

**PGE — Screen Video Pattern Enable**

Set this bit to enable the free-running full-screen video pattern. Reset clears this bit.

- 1 = Screen video pattern enabled
- 0 = Screen video pattern disabled

**PGR, PGG, PGB — Screen Video Pattern Color**

These bits define the color of the free-running full-screen video pattern.



## Section 19. Input/Output (I/O) Ports

### 19.1 Contents

19.2	Introduction	294
19.3	Port A	297
19.3.1	Port A Data Register	297
19.3.2	Data Direction Register A	298
19.3.3	Port A Options	299
19.4	Port B	300
19.4.1	Port B Data Register	300
19.4.2	Data Direction Register B	301
19.4.3	Port B Options	302
19.5	Port C	303
19.5.1	Port C Data Register	303
19.5.2	Data Direction Register C	304
19.5.3	Port C Options	305
19.6	Port D	306
19.6.1	Port D Data Register	306
19.6.2	Data Direction Register D	307
19.6.3	Port D Options	309
19.7	Port E	311
19.7.1	Port E Data Register	311
19.7.2	Data Direction Register E	312
19.7.3	Port E Options	313

## 19.2 Introduction

Thirty-nine (39) bidirectional input-output (I/O) pins form five parallel ports. All I/O pins are programmable as inputs or outputs.

**NOTE:** Connect any unused I/O pins to an appropriate logic level, either  $V_{DD}$  or  $V_{SS}$ . Although the I/O ports do not require termination for proper operation, termination reduces excess current consumption and the possibility of electrostatic damage.

Addr.	Register Name	Bit 7	6	5	4	3	2	1	Bit 0	
\$0000	Port A Data Register (PTA)	Read:	PTA7	PTA6	PTA5	PTA4	PTA3	PTA2	PTA1	PTA0
		Write:								
		Reset:	Unaffected by reset							
\$0001	Port B Data Register (PTB)	Read:	PTB7	PTB6	PTB5	PTB4	PTB3	PTB2	PTB1	PTB0
		Write:								
		Reset:	Unaffected by reset							
\$0002	Port C Data Register (PTC)	Read:	0	PTC6	PTC5	PTC4	PTC3	PTC2	PTC1	PTC0
		Write:								
		Reset:	Unaffected by reset							
\$0003	Port D Data Register (PTD)	Read:	PTD7	PTD6	PTD5	PTD4	PTD3	PTD2	PTD1	PTD0
		Write:								
		Reset:	Unaffected by reset							
\$0004	Data Direction Register A (DDRA)	Read:	DDRA7	DDRA6	DDRA5	DDRA4	DDRA3	DDRA2	DDRA1	DDRA0
		Write:								
		Reset:	0	0	0	0	0	0	0	0
\$0005	Data Direction Register B (DDRB)	Read:	DDRB7	DDRB6	DDRB5	DDRB4	DDRB3	DDRB2	DDRB1	DDRB0
		Write:								
		Reset:	0	0	0	0	0	0	0	0

 = Unimplemented

**Figure 19-1. Port I/O Register Summary**

Addr.	Register Name	Bit 7	6	5	4	3	2	1	Bit 0	
\$0006	Data Direction Register C (DDRC)	Read:	0	DDRC6	DDRC5	DDRC4	DDRC3	DDRC2	DDRC1	DDRC0
		Write:								
		Reset:	0	0	0	0	0	0	0	0
\$0007	Data Direction Register D (DDR D)	Read:	DDR D7	DDR D6	DDR D5	DDR D4	DDR D3	DDR D2	DDR D1	DDR D0
		Write:								
		Reset:	0	0	0	0	0	0	0	0
\$0008	Port E Data Register (PTE)	Read:	PTE7	PTE6	PTE5	PTE4	PTE3	PTE2	PTE1	PTE0
		Write:								
		Reset:	Unaffected by reset							
\$0009	Data Direction Register E (DDRE)	Read:	DDRE7	DDRE6	DDRE5	DDRE4	DDRE3	DDRE2	DDRE1	DDRE0
		Write:								
		Reset:	0	0	0	0	0	0	0	0
\$004F	Keyboard Interrupt Enable Register (KBIER)	Read:	KBIE7	KBIE6	KBIE5	KBIE4	KBIE3	KBIE2	KBIE1	KBIE0
		Write:								
		Reset:	0	0	0	0	0	0	0	0
\$0068	Port-E Control Register (PECR)	Read:				R	USBDS4E	USBDS3E	USBDS2E	USBDS1E
		Write:								
		Reset:					0	0	0	0
\$0069	Port-D Control Register (PDCR)	Read:	IICDATE	IICSCLE	DDCDATE	DDCSCLE	HOUTE	VOUTE	DEE	DCLKE
		Write:								
		Reset:	0	0	0	0	0	0	0	0
\$0078	PWM Control Register (PWMCR)	Read:	PWM7E	PWM6E	PWM5E	PWM4E	PWM3E	PWM2E	PWM1E	PWM0E
		Write:								
		Reset:	0	0	0	0	0	0	0	0

 = Unimplemented

**Figure 19-1. Port I/O Register Summary (Continued)**

## Table 19-1. Port Control Register Bits Summary

Port	Bit	DDR	Module Control			Pin
			Module	Register	Control Bit	
A	0	DDRA0	KBI	KBIER \$004F	KBIE0	PTA0/KBI0
	1	DDRA1			KBIE1	PTA1/KBI1
	2	DDRA2			KBIE2	PTA2/KBI2
	3	DDRA3			KBIE3	PTA3/KBI3
	4	DDRA4			KBIE4	PTA4/KBI4
	5	DDRA5			KBIE5	PTA5/KBI5
	6	DDRA6			KBIE6	PTA6/KBI6
	7	DDRA7			KBIE7	PTA7/KBI7
B	0	DDRB0	PWM	PWMCR \$0078	PWM0E	PTB0/PWM0
	1	DDRB1			PWM1E	PTB1/PWM1
	2	DDRB2			PWM2E	PTB2/PWM2
	3	DDRB3			PWM3E	PTB3/PWM3
	4	DDRB4			PWM4E	PTB4/PWM4
	5	DDRB5			PWM5E	PTB5/PWM5
	6	DDRB6			PWM6E	PTB6/PWM6
	7	DDRB7			PWM7E	PTB7/PWM7
C	0	DDRC0	ADC	ADSCR \$003B	ADCH[4:0]	PTC0/ADC0
	1	DDRC1				PTC1/ADC1
	2	DDRC2				PTC2/ADC2
	3	DDRC3				PTC3/ADC3
	4	DDRC4				PTC4/ADC4
	5	DDRC5				PTC5/ADC5
	6	DDRC6	—	—	—	PTC6
D	0	DDRD0	SYNC	PDCR \$0069	DCLKE	PTD0/DCLK
	1	DDRD1			DEE	PTD1/DE
	2	DDRD2			VOUTE	PTD2/VOUT
	3	DDRD3			HOUTE	PTD3/HOUT
	4	DDRD4	DDC12AB		DDCSCLE	PTD4/DDCSCSCL
	5	DDRD5			DDCDATE	PTD5/DDCSDA
	6	DDRD6	MMIIC		IICSCLE	PTD6/IICSCSCL
	7	DDRD7			IICDATE	PTD7/IICSDA
E	0	DDRE0	USB	PECR \$0068	USBDS1E	PTE0/DPLUS1
	1	DDRE1				PTE1/DMINUS1
	2	DDRE2			USBDS2E	PTE2/DPLUS2
	3	DDRE3				PTE3/DMINUS2
	4	DDRE4			USBDS3E	PTE4/DPLUS3
	5	DDRE5				PTE5/DMINUS3
	6	DDRE6			USBDS4E	PTE6/DPLUS4
	7	DDRE7				PTE7/DMINUS4



## 19.3 Port A

Port A is an 8-bit special-function port that shares all eight of its pins with the keyboard interrupt module (KBI). (See [Section 21. Keyboard Interrupt Module \(KBI\)](#).)

### 19.3.1 Port A Data Register

The port A data register (PTA) contains a data latch for each of the eight port A pins.

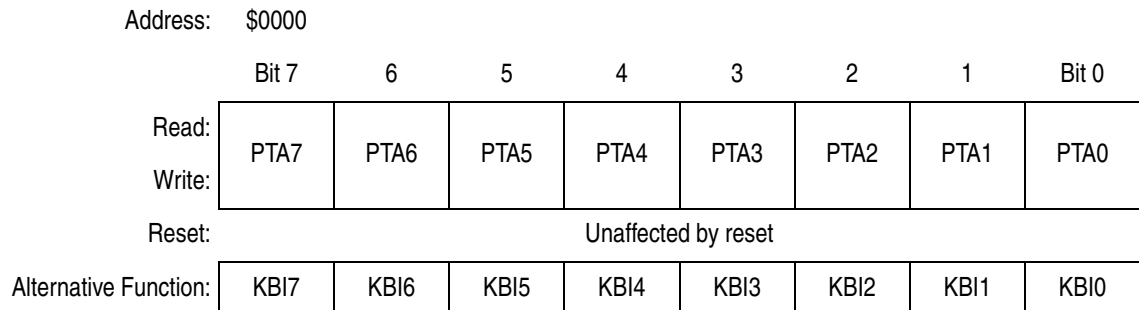

**Figure 19-2. Port A Data Register (PTA)**

#### PTA[7:0] — Port A Data Bits

These read/write bits are software programmable. Data direction of each port A pin is under the control of the corresponding bit in data direction register A. Reset has no effect on port A data.

#### KBI[7:0] — Keyboard Interrupt Pins

The keyboard interrupt enable bits, KBIE[7:0], in the keyboard interrupt enable register (KBIER), enable the port A pins as external interrupt pins. (See [19.3.3 Port A Options](#) and [Section 21. Keyboard Interrupt Module \(KBI\)](#).)

## 19.3.2 Data Direction Register A

Data direction register A (DDRA) determines whether each port A pin is an input or an output. Writing a logic 1 to a DDRA bit enables the output buffer for the corresponding port A pin; a logic 0 disables the output buffer.

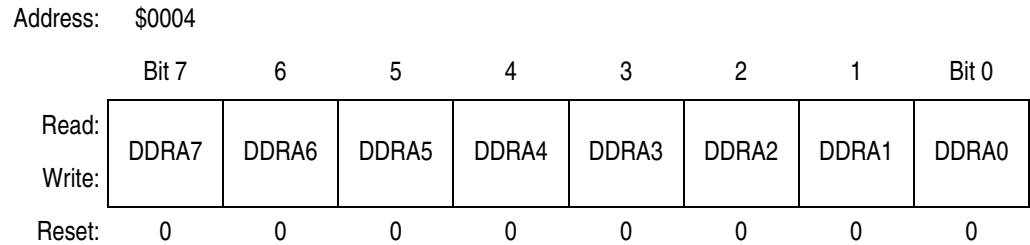

**Figure 19-3. Data Direction Register A (DDRA)**

### DDRA[7:0] — Data Direction Register A Bits

These read/write bits control port A data direction. Reset clears DDRA[7:0], configuring all port A pins as inputs.

- 1 = Corresponding port A pin configured as output
- 0 = Corresponding port A pin configured as input

**NOTE:** Avoid glitches on port A pins by writing to the port A data register before changing data direction register A bits from 0 to 1.

Figure 19-4 shows the port A I/O logic.

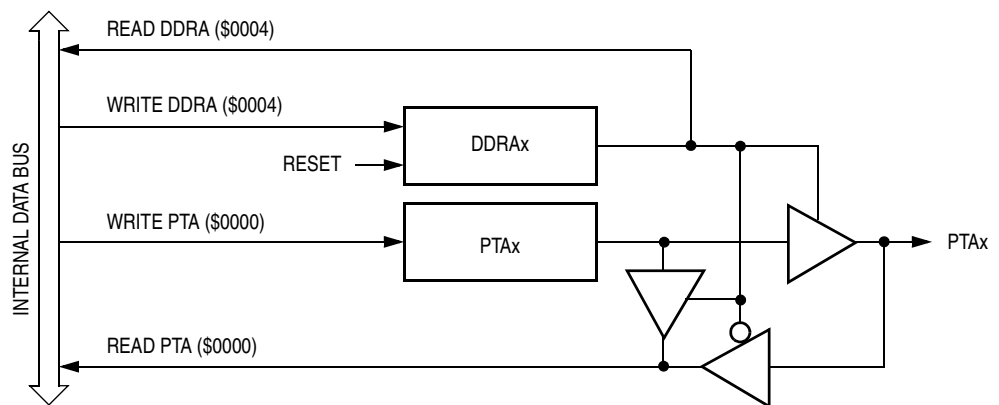

**Figure 19-4. Port A I/O Circuit**

When bit DDRAx is a logic 1, reading address \$0000 reads the PTAx data latch. When bit DDRAx is a logic 0, reading address \$0000 reads the voltage level on the pin. The data latch can always be written, regardless of the state of its data direction bit. [Table 19-2](#) summarizes the operation of the port A pins.

**Table 19-2. Port A Pin Functions**

DDRA Bit	PTA Bit	I/O Pin Mode	Accesses to DDRA	Accesses to PTA	
			Read/Write	Read	Write
0	X <sup>(1)</sup>	Input, Hi-Z <sup>(2)</sup>	DDRA[7:0]	Pin	PTA[7:0] <sup>(3)</sup>
1	X	Output	DDRA[7:0]	PTA[7:0]	PTA[7:0]

**Notes:**

1. X = don't care.
2. Hi-Z = high impedance.
3. Writing affects data register, but does not affect input.

### 19.3.3 Port A Options

The keyboard interrupt enable register (KBIER) selects the port A pins for keyboard interrupt function or as standard I/O function. (See [Section 21. Keyboard Interrupt Module \(KBI\)](#).)

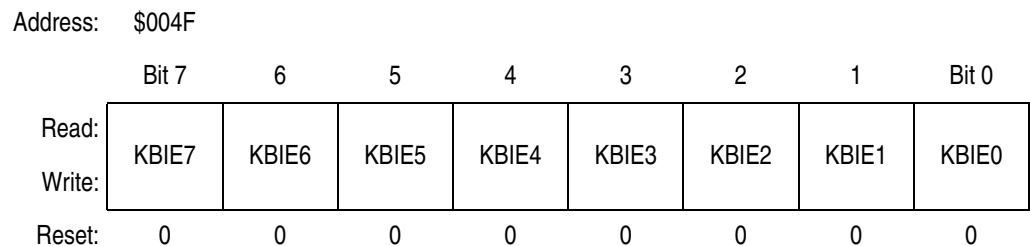

**Figure 19-5. Keyboard Interrupt Enable Register (KIER)**

KBIE[7:0] — Keyboard Interrupt Enable Bits

Setting a KBIE<sub>x</sub> bit to logic 1 configures the PTAx/KBIE<sub>x</sub> pin for keyboard interrupt function. Reset clears the KBIE<sub>x</sub> bits.

1 = PTAx/KBIE<sub>x</sub> pin configured as KBIE<sub>x</sub> interrupt pin

0 = PTAx/KBIE<sub>x</sub> pin configured as PTAx standard I/O pin

## 19.4 Port B

Port B is an 8-bit special-function port that shares all eight of its pins with the pulse width modulator (PWM). (See [Section 12. Pulse Width Modulator \(PWM\)](#).)

### 19.4.1 Port B Data Register

The port B data register (PTB) contains a data latch for each of the eight port pins.

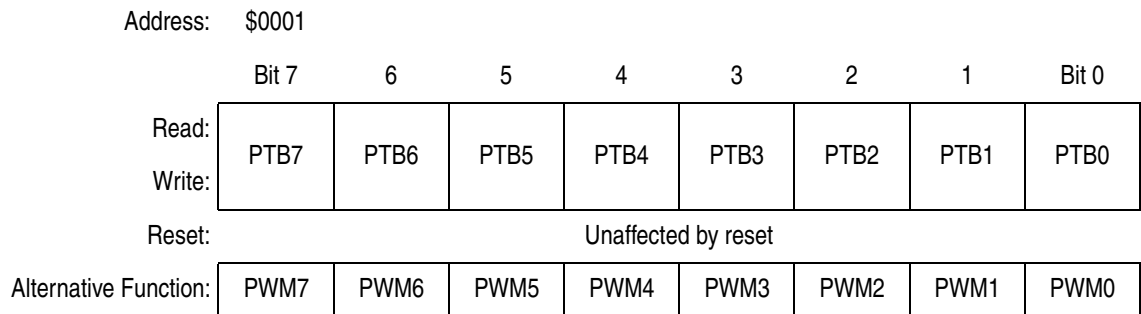

**Figure 19-6. Port B Data Register (PTB)**

#### PTB[7:0] — Port B Data Bits

These read/write bits are software-programmable. Data direction of each port B pin is under the control of the corresponding bit in data direction register B. Reset has no effect on port B data.

#### PWM[7:0] — PWM Outputs Pins

The PWM output enable bits PWM7E–PWM0E, in the PWM control register (PWMCR) enable port B pins as PWM output pins. (See [19.4.3 Port B Options](#) and [Section 12. Pulse Width Modulator \(PWM\)](#).)

### 19.4.2 Data Direction Register B

Data direction register B (DDRB) determines whether each port B pin is an input or an output. Writing a logic 1 to a DDRB bit enables the output buffer for the corresponding port B pin; a logic 0 disables the output buffer.

Address: \$0005

	Bit 7	6	5	4	3	2	1	Bit 0
Read:	DDRB7	DDRB6	DDRB5	DDRB4	DDRB3	DDRB2	DDRB1	DDRB0
Write:								
Reset:	0	0	0	0	0	0	0	0

**Figure 19-7. Data Direction Register B (DDRB)**

#### DDRB[7:0] — Data Direction Register B Bits

These read/write bits control port B data direction. Reset clears DDRB[7:0], configuring all port B pins as inputs.

- 1 = Corresponding port B pin configured as output
- 0 = Corresponding port B pin configured as input

**NOTE:** Avoid glitches on port B pins by writing to the port B data register before changing data direction register B bits from 0 to 1.

Figure 19-8 shows the port B I/O logic.

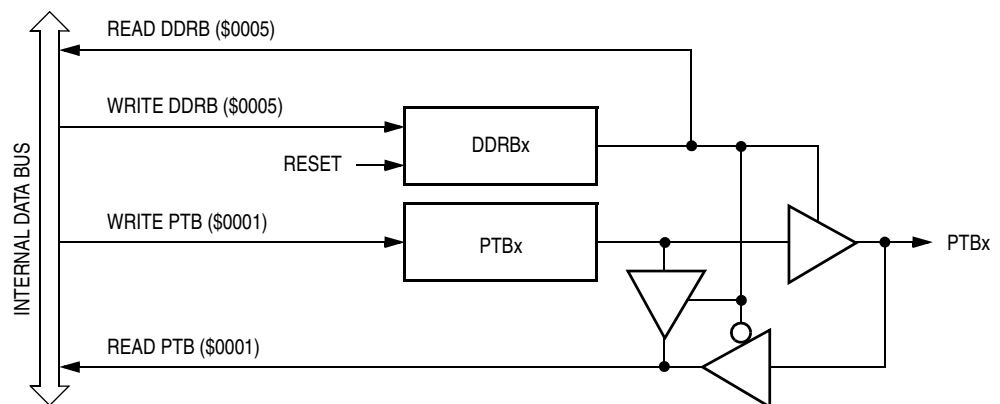

**Figure 19-8. Port B I/O Circuit**

When bit DDRBx is a logic 1, reading address \$0001 reads the PTBx data latch. When bit DDRBx is a logic 0, reading address \$0001 reads the voltage level on the pin. The data latch can always be written, regardless of the state of its data direction bit. **Table 19-3** summarizes the operation of the port B pins.

**Table 19-3. Port B Pin Functions**

DDR B Bit	PTB Bit	I/O Pin Mode	Accesses to DDRB		Accesses to PTB	
			Read/Write	Read	Write	
0	X <sup>(1)</sup>	Input, Hi-Z <sup>(2)</sup>	DDR B[7:0]	Pin	PTB[7:0] <sup>(3)</sup>	
1	X	Output	DDR B[7:0]	PTB[7:0]	PTB[7:0]	

**Notes:**

1. X = don't care.
2. Hi-Z = high impedance.
3. Writing affects data register, but does not affect input.

### 19.4.3 Port B Options

The PWM control register (PWMCR) selects the port B pins for PWM function or as standard I/O function. (See **Section 12. Pulse Width Modulator (PWM).**)

Address: \$0078

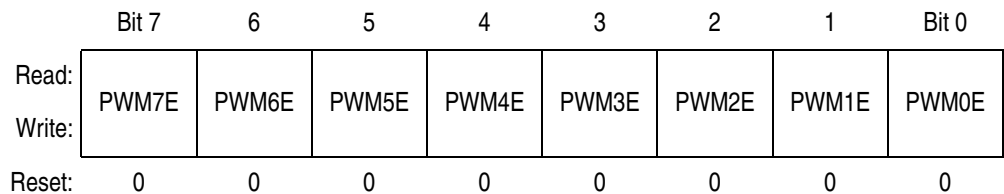

**Figure 19-9. PWM Control Register (PWMCR)**

#### PWM7E–PWM0E — PWM Output Enable Bits

Setting a PWMx E bit to logic 1 configures the PTBx/PWMx pin for PWM output function. Reset clears the PWMx E bits.

- 1 = PTBx/PWMx pin configured as PWMx interrupt pin
- 0 = PTBx/PWMx pin configured as PTBx standard I/O pin

## 19.5 Port C

Port C is an 7-bit special-function port that shares six of its pins with the analog-to-digital converter (ADC) module. (See [Section 13. Analog-to-Digital Converter \(ADC\)](#).)

### 19.5.1 Port C Data Register

The port C data register (PTC) contains a data latch for each of the seven port C pins.

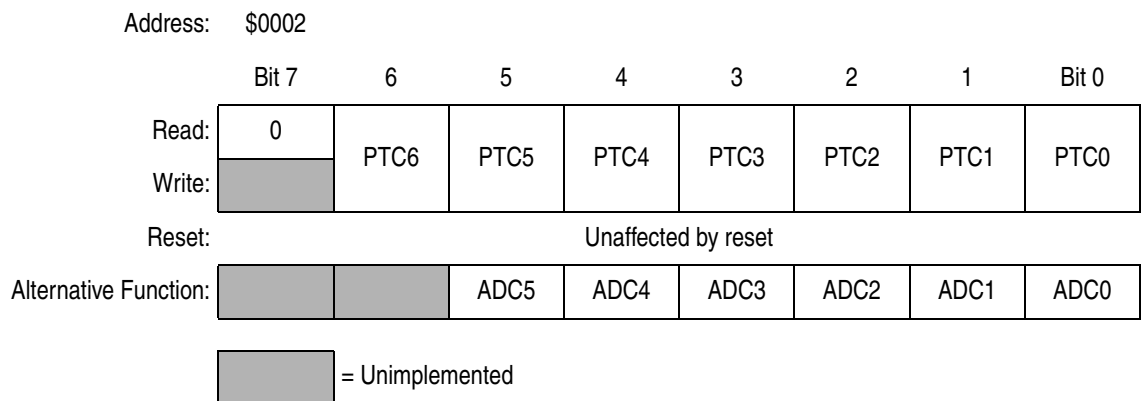

**Figure 19-10. Port C Data Register (PTC)**

#### PTC[6:0] — Port C Data Bits

These read/write bits are software-programmable. Data direction of each port C pin is under the control of the corresponding bit in data direction register C. Reset has no effect on port C data.

#### ADC[5:0] — Analog-to-Digital Input Pins

ADC[5:0] are pins used for the input channels to the analog-to-digital converter module. The channel select bits, ADCH[4:0], in the [ADC Status and Control Register](#) define which port C pin will be used as an ADC input and overrides any control from the port I/O logic. (See [19.5.3 Port C Options](#) and [Section 13. Analog-to-Digital Converter \(ADC\)](#).)

**NOTE:** Care must be taken when reading port C while applying analog voltages to ADC5–ADC0 pins. If the appropriate ADC channel is not enabled, excessive current drain may occur if analog voltages are applied to the PTCx/ADCx pin, while PTC is read as a digital input. Those ports not selected as analog input channels are considered digital I/O ports.

## 19.5.2 Data Direction Register C

Data direction register C (DDRC) determines whether each port C pin is an input or an output. Writing a logic 1 to a DDRC bit enables the output buffer for the corresponding port C pin; a logic 0 disables the output buffer.

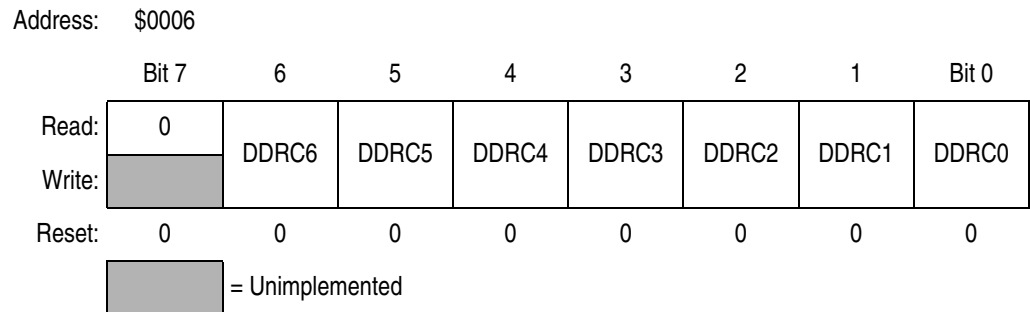

**Figure 19-11. Data Direction Register C (DDRC)**

### DDRC[6:0] — Data Direction Register C Bits

These read/write bits control port C data direction. Reset clears DDRC[6:0], configuring all port C pins as inputs.

1 = Corresponding port C pin configured as output

0 = Corresponding port C pin configured as input

**NOTE:** Avoid glitches on port C pins by writing to the port C data register before changing data direction register C bits from 0 to 1.

**Figure 19-12** shows the port C I/O logic.



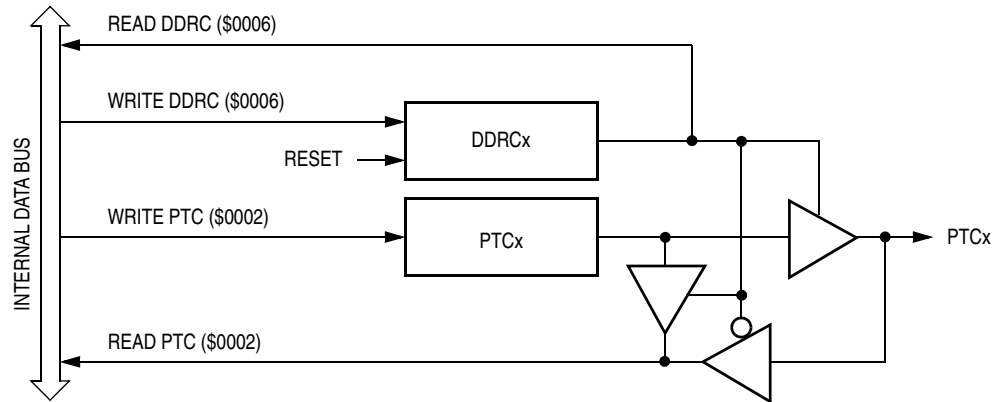

**Figure 19-12. Port C I/O Circuit**

When bit DDRCx is a logic 1, reading address \$0002 reads the PTCx data latch. When bit DDRCx is a logic 0, reading address \$0002 reads the voltage level on the pin. The data latch can always be written, regardless of the state of its data direction bit. [Table 19-4](#) summarizes the operation of the port C pins.

**Table 19-4. Port C Pin Functions**

DDRC Bit	PTC Bit	I/O Pin Mode	Accesses to DDRC		Accesses to PTC	
			Read/Write		Read	Write
0	X <sup>(1)</sup>	Input, Hi-Z <sup>(2)</sup>	DDRC[6:0]		Pin	PTC[6:0] <sup>(3)</sup>
1	X	Output	DDRC[6:0]		PTC[6:0]	PTC[6:0]

**Notes:**

1. X = don't care.
2. Hi-Z = high impedance.
3. Writing affects data register, but does not affect input.

### 19.5.3 Port C Options

The ADCH[4:0] bits in the [ADC Status and Control Register](#) defines which PTCx/ADCx pin is used as an ADC input and overrides any control from the port I/O logic by forcing that pin as the input to the analog circuitry. (See [Section 13. Analog-to-Digital Converter \(ADC\)](#).)

## 19.6 Port D

Port D is an 8-bit special-function port that shares two of its pins with the multi-master IIC (MMIIC) module, two of its pins with the DDC12AB module, and four of its pins with the sync processor.

### 19.6.1 Port D Data Register

The port D data register (PTD) contains a data latch for each of the eight port D pins.

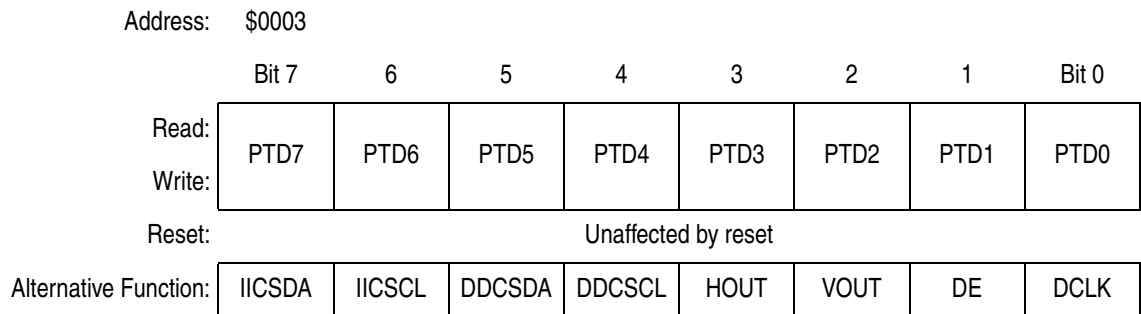

**Figure 19-13. Port D Data Register (PTD)**

#### PTD[7:0] — Port D Data Bits

These read/write bits are software-programmable. Data direction of each port D pin is under the control of the corresponding bit in data direction register D. Reset has no effect on port D data.

#### IICSDA, IIC\_SCL — Multi-master IIC Data and Clock pins

The PTD7/IICSDA and PTD6/IIC\_SCL pins are multi-master IIC data and clock pins. When the IICDATE and IICSCLE bits in the port D control register (PDCR) are clear, the PTD7/IICSDA and PTD6/IIC\_SCL pins are available for general-purpose I/O. (See [19.6.3 Port D Options](#).)

#### DDC\_SCL, DDCSDA — DDC12AB Data and Clock pins

The PTD4/DDC\_SCL and PTD5/DDCSDA pins are DDC12AB clock and data pins respectively. When the DDCSCLE and DDCDATE bits in the port D control register (PDCR) are clear, the PTD4/DDC\_SCL and PTD5/DDCSDA pins are available for general-purpose I/O. (See [19.6.3 Port D Options](#).)

### HOUT— Sync Processor HOUT Pulse Output Pin

The PTD3/HOUT pin is the sync processor HOUT pulse output pin. When the HOUTE bit in the port D control register (PDCR) is clear, the PTD3/HOUT pin is available for general-purpose I/O. (See [19.6.3 Port D Options](#).)

### VOUT — Sync Processor VOUT Pulse Output Pin

The PTD2/VOUT pin is the sync processor VOUT pulse output pin. When the VOUTE bit in the port D control register (PDCR) is clear, the PTD2/VOUT pin is available for general-purpose I/O. (See [19.6.3 Port D Options](#).)

### DE — Sync Processor DE Pulse Output Pin

The PTD1/DE pin is the sync processor DE pulse output pin. When the DEE bit in the port D control register (PDCR) is clear, the PTD1/DE pin is available for general-purpose I/O. (See [19.6.3 Port D Options](#).)

### DCLK — Sync Processor DCLK Pulse Output Pin

The PTD0/DCLK pin is the sync processor DCLK pulse output pin. When the DCLKE bit in the port D control register (PDCR) is clear, the PTD0/DCLK pin is available for general-purpose I/O. (See [19.6.3 Port D Options](#).)

## 19.6.2 Data Direction Register D

Data direction register D (DDRD) determines whether each port D pin is an input or an output. Writing a logic 1 to a DDRD bit enables the output buffer for the corresponding port D pin; a logic 0 disables the output buffer.

Address: \$0007

	Bit 7	6	5	4	3	2	1	Bit 0
Read:	DDRD7	DDRD6	DDRD5	DDRD4	DDRD3	DDRD2	DDRD1	DDRD0
Write:								
Reset:	0	0	0	0	0	0	0	0

**Figure 19-14. Data Direction Register D (DDRD)**

## DDRD[7:0] — Data Direction Register D Bits

These read/write bits control port D data direction. Reset clears DDRD[7:0], configuring all port D pins as inputs.

- 1 = Corresponding port D pin configured as output
- 0 = Corresponding port D pin configured as input

**NOTE:** Avoid glitches on port D pins by writing to the port D data register before changing data direction register D bits from 0 to 1.

Figure 19-15 shows the port D I/O logic.

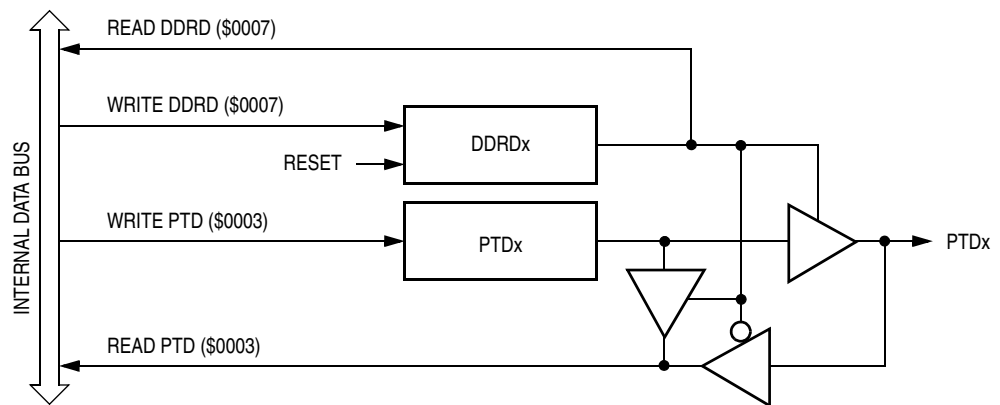

**Figure 19-15. Port D I/O Circuit**

When bit DDRDx is a logic 1, reading address \$0003 reads the PTDx data latch. When bit DDRDx is a logic 0, reading address \$0003 reads the voltage level on the pin. The data latch can always be written, regardless of the state of its data direction bit. Table 19-5 summarizes the operation of the port D pins.

**Table 19-5. Port D Pin Functions**

DDRD Bit	PTD Bit	I/O Pin Mode	Accesses to DDRD	Accesses to PTD	
			Read/Write	Read	Write
0	X <sup>(1)</sup>	Input, Hi-Z <sup>(2)</sup>	DDRD[7:0]	Pin	PTD[7:0] <sup>(3)</sup>
1	X	Output	DDRD[7:0]	PTD[7:0]	PTD[7:0]

**Notes:**

1. X = don't care.
2. Hi-Z = high impedance.
3. Writing affects data register, but does not affect the input.

### 19.6.3 Port D Options

The port D control register (PDCR) selects the port D pins for module function or as standard I/O function.

Address: \$0069

	Bit 7	6	5	4	3	2	1	Bit 0
Read:	IICDATE	IICSCLE	DDCDATE	DDCSCLE	HOUTE	VOUTE	DEE	DCLKE
Write:								
Reset:	0	0	0	0	0	0	0	0

**Figure 19-16. Port D Control Register (PDCR)**

#### IICDATE — MMIIC Data Pin Enable

This bit is set to configure the PTD7/IICSDA pin for IICSDA function. Reset clears this bit.

- 1 = PTD7/IICSDA pin configured as IICSDA pin
- 0 = PTD7/IICSDA pin configured as standard I/O pin

#### IICSCLE — MMIIC Clock Pin Enable

This bit is set to configure the PTD6/IICSCSCL pin for IICSCSCL function. Reset clears this bit.

- 1 = PTD6/IICSCSCL pin configured as IICSCSCL pin
- 0 = PTD6/IICSCSCL pin configured as standard I/O pin

#### DDCDATE — DDC Data Pin Enable

This bit is set to configure the PTD5/DDCSDA pin for DDCSDA function. Reset clears this bit.

- 1 = PTD5/DDCSDA pin configured as DDCSDA pin
- 0 = PTD5/DDCSDA pin configured as standard I/O port

#### DDCSCLE — DDC Clock Pin Enable

This bit is set to configure the PTD4/DDCSCL pin for DDCSCL function. Reset clears this bit.

- 1 = PTD4/DDCSCL pin configured as DDCSCL pin
- 0 = PTD4/DDCSCL pin configured as standard I/O port

### HOUTE — HOUT Pin Enable

This bit is set to configure the PTD3/HOUT pin for sync processor HOUT output. Reset clears this bit.

1 = PTD3/HOUT pin configured as HOUT pin

0 = PTD3/HOUT pin configured as standard I/O pin

### VOUTE — VOUT Pin Enable

This bit is set to configure the PTD2/VOUT pin for sync processor VOUT output. Reset clears this bit.

1 = PTD2/VOUT pin configured as VOUT pin

0 = PTD2/VOUT pin configured as standard I/O pin

### DEE — DE Pin Enable

This bit is set to configure the PTD1/DE pin for sync processor DE output. Reset clears this bit.

1 = PTD1/DE pin configured as DE pin

0 = PTD1/DE pin configured as standard I/O pin

### DCLKE — DCLK Pin Enable

This bit is set to configure the PTD0/DCLK pin for sync processor DCLK output. Reset clears this bit.

1 = PTD0/DCLK pin configured as DCLK pin

0 = PTD0/DCLK pin configured as standard I/O pin

## 19.7 Port E

Port E is an 8-bit special-function port that shares all of its pins with the universal serial bus module. (See [Section 14. Universal Serial Bus Module \(USB\)](#).)

### 19.7.1 Port E Data Register

The port E data register (PTE) contains a data latch for each of the eight port E pins.

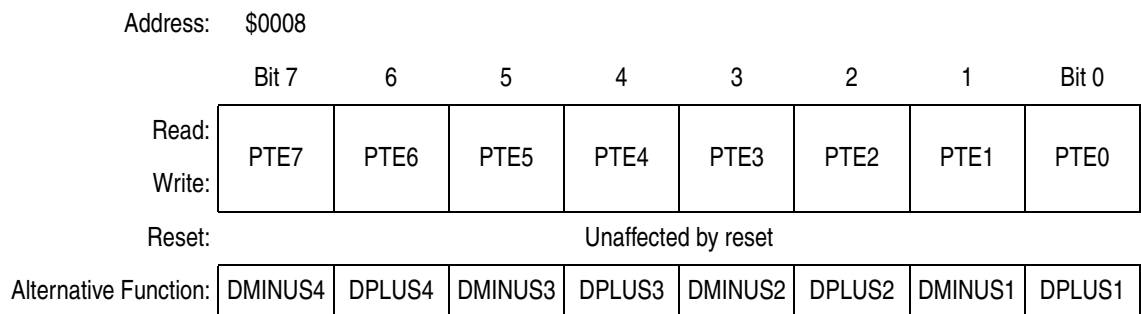

**Figure 19-17. Port E Data Register (PTE)**

#### PTE[7:0] — Port E Data Bits

These read/write bits are software-programmable. Data direction of each port E pin is under the control of the corresponding bit in data direction register E. Reset has no effect on port E data.

#### DPLUSx and DMINUSx — Downstream Pairs of USB HUB Data Pins

The DPLUSx and DMINUSx pins are the data pin pairs of the universal serial bus HUB. When the USBDSxE bit in the port E control register (PECR) is clear, the corresponding PTE/DPLUSx and PTE/DMINUSx pins are available for general-purpose I/O. (See [19.7.3 Port E Options](#).)

## 19.7.2 Data Direction Register E

Data direction register E (DDRE) determines whether each port E pin is an input or an output. Writing a logic 1 to a DDRE bit enables the output buffer for the corresponding port E pin; a logic 0 disables the output buffer.

Address: \$0009

	Bit 7	6	5	4	3	2	1	Bit 0
Read:	DDRE7	DDRE6	DDRE5	DDRE4	DDRE3	DDRE2	DDRE1	DDRE0
Write:								
Reset:	0	0	0	0	0	0	0	0

**Figure 19-18. Data Direction Register E (DDRE)**

### DDRE[7:0] — Data Direction Register E Bits

These read/write bits control port E data direction. Reset clears DDRE[7:0], configuring all port E pins as inputs.

- 1 = Corresponding port E pin configured as output
- 0 = Corresponding port E pin configured as input

**NOTE:** Avoid glitches on port E pins by writing to the port E data register before changing data direction register E bits from 0 to 1.

Figure 19-19 shows the port E I/O logic.

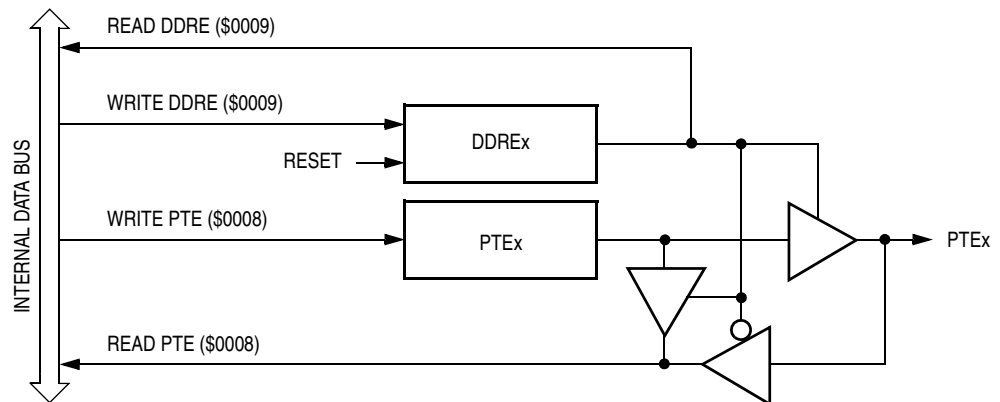

**Figure 19-19. Port E I/O Circuit**



When bit DDREx is a logic 1, reading address \$0008 reads the PTE<sub>x</sub> data latch. When bit DDREx is a logic 0, reading address \$0008 reads the voltage level on the pin. The data latch can always be written, regardless of the state of its data direction bit. **Table 19-6** summarizes the operation of the port E pins.

**Table 19-6. Port E Pin Functions**

DDRE Bit	PTE Bit	I/O Pin Mode	Accesses to DDRE	Accesses to PTD	
			Read/Write	Read	Write
0	X <sup>(1)</sup>	Input, Hi-Z <sup>(2)</sup>	DDRE[7:0]	Pin	PTE[7:0] <sup>(3)</sup>
1	X	Output	DDRE[7:0]	PTE[7:0]	PTE[7:0]

**Notes:**

1. X = don't care.
2. Hi-Z = high impedance.
3. Writing affects data register, but does not affect the input.

### 19.7.3 Port E Options

The Port E control register (PECR) selects the port E pins for USB module function or as standard I/O function.

Address: \$0068

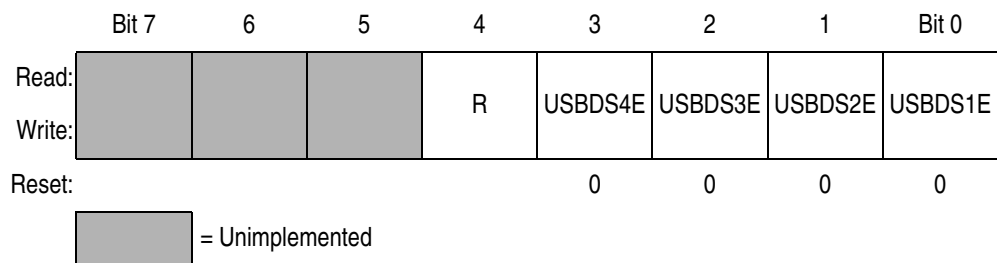

**Figure 19-20. Port E Control Register (PECR)**

#### USBDS4E–USBDS1E — USB HUB Data Pins Enable

Setting a USBDS<sub>x</sub>E bit to logic 1 configures the corresponding PTE/DPLUS<sub>x</sub> and PTE/DMINUS<sub>x</sub> pins for USB HUB downstream port function. Reset clears the USBDS<sub>x</sub>E bits.

- 1 = PTE/DPLUS<sub>x</sub> and PTE/DMINUS<sub>x</sub> pins configured as USB pins
- 0 = PTE/DPLUS<sub>x</sub> and PTE/DMINUS<sub>x</sub> pins configured as standard I/O pins



## Section 20. External Interrupt (IRQ)

### 20.1 Contents

20.2	Introduction .....	315
20.3	Features .....	315
20.4	Functional Description .....	316
20.4.1	$\overline{\text{IRQ}}$ Pin .....	318
20.5	IRQ Status and Control Register (INTSCR) .....	319
20.6	IRQ Module During Break Interrupts .....	320

### 20.2 Introduction

The IRQ (external interrupt) module provides a maskable interrupt input.

### 20.3 Features

Features of the IRQ module include the following:

- A dedicated external interrupt pin,  $\overline{\text{IRQ}}$
- IRQ interrupt control bits
- Hysteresis buffer
- Programmable edge-only or edge and level interrupt sensitivity
- Automatic interrupt acknowledge
- Internal pull-up resistor

### 20.4 Functional Description

A logic 0 applied to the external interrupt pin can latch a CPU interrupt request. **Figure 20-1** shows the structure of the IRQ module.

Interrupt signals on the  $\overline{\text{IRQ}}$  pin are latched into the IRQ latch. An interrupt latch remains set until one of the following actions occurs:

- Vector fetch — A vector fetch automatically generates an interrupt acknowledge signal that clears the IRQ latch.
- Software clear — Software can clear the interrupt latch by writing to the acknowledge bit in the interrupt status and control register (INTSCR). Writing a logic 1 to the ACK bit clears the IRQ latch.
- Reset — A reset automatically clears the interrupt latch.

The external interrupt pin is falling-edge-triggered and is software-configurable to be either falling-edge or falling-edge and low-level-triggered. The MODE bit in the INTSCR controls the triggering sensitivity of the  $\overline{\text{IRQ}}$  pin.

When the interrupt pin is edge-triggered only, the CPU interrupt request remains set until a vector fetch, software clear, or reset occurs.

When the interrupt pin is both falling-edge and low-level-triggered, the CPU interrupt request remains set until both of the following occur:

- Vector fetch or software clear
- Return of the interrupt pin to logic 1

The vector fetch or software clear may occur before or after the interrupt pin returns to logic 1. As long as the pin is low, the interrupt request remains pending. A reset will clear the latch and the MODE control bit, thereby clearing the interrupt even if the pin stays low.

When set, the IMASK bit in the INTSCR mask all external interrupt requests. A latched interrupt request is not presented to the interrupt priority logic unless the IMASK bit is clear.

**NOTE:** The interrupt mask (I) in the condition code register (CCR) masks all interrupt requests, including external interrupt requests. (See 9.6 Exception Control.)

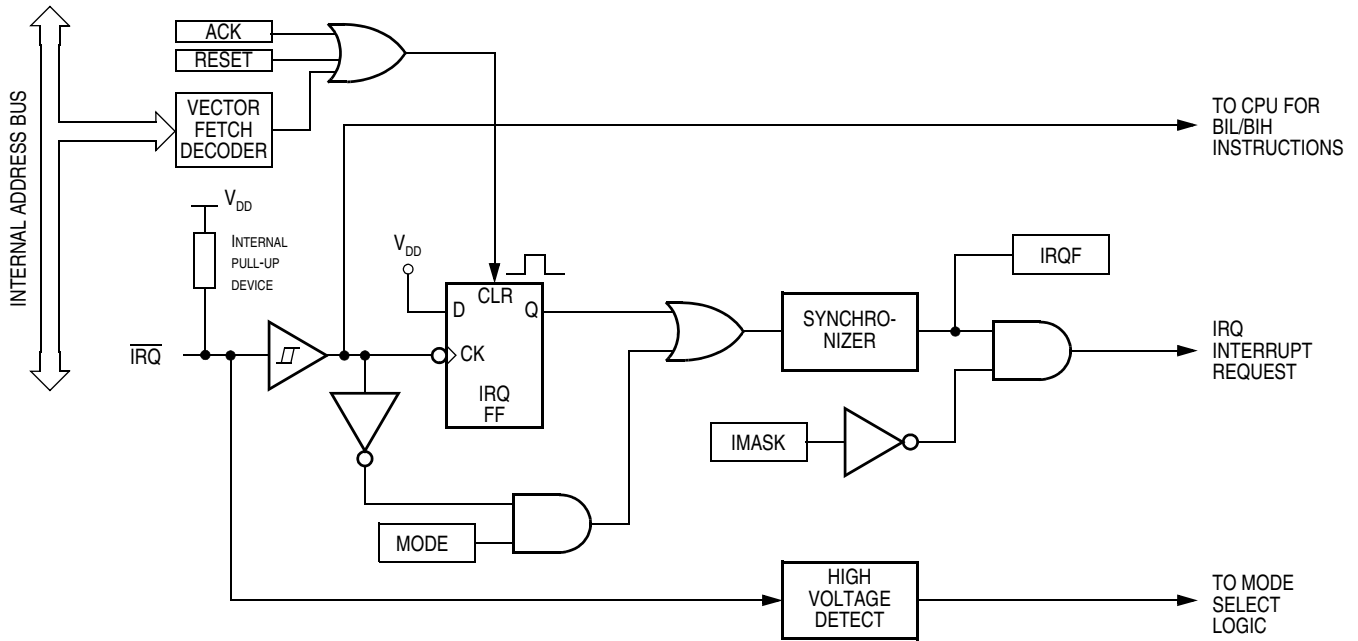

Figure 20-1. IRQ Module Block Diagram

Addr.	Register Name	Bit 7	6	5	4	3	2	1	Bit 0	
\$001E	IRQ Status and Control Register (INTSCR)	Read:	0	0	0	0	IRQF	0	IMASK	MODE
		Write:	Unimplemented					ACK		
		Reset:	0	0	0	0	0	0	0	0

Unimplemented

Figure 20-2. IRQ I/O Register Summary

### 20.4.1 $\overline{\text{IRQ}}$ Pin

A logic 0 on the  $\overline{\text{IRQ}}$  pin can latch an interrupt request into the IRQ latch. A vector fetch, software clear, or reset clears the IRQ latch.

If the MODE bit is set, the  $\overline{\text{IRQ}}$  pin is both falling-edge-sensitive and low-level-sensitive. With MODE set, both of the following actions must occur to clear IRQ:

- Vector fetch or software clear — A vector fetch generates an interrupt acknowledge signal to clear the latch. Software may generate the interrupt acknowledge signal by writing a logic 1 to the ACK bit in the interrupt status and control register (INTSCR). The ACK bit is useful in applications that poll the  $\overline{\text{IRQ}}$  pin and require software to clear the IRQ latch. Writing to the ACK bit prior to leaving an interrupt service routine can also prevent spurious interrupts due to noise. Setting ACK does not affect subsequent transitions on the  $\overline{\text{IRQ}}$  pin. A falling edge that occurs after writing to the ACK bit latches another interrupt request. If the IRQ mask bit, IMASK, is clear, the CPU loads the program counter with the vector address at locations \$FFFA and \$FFFB.
- Return of the  $\overline{\text{IRQ}}$  pin to logic 1 — As long as the  $\overline{\text{IRQ}}$  pin is at logic 0, IRQ remains active.

The vector fetch or software clear and the return of the  $\overline{\text{IRQ}}$  pin to logic 1 may occur in any order. The interrupt request remains pending as long as the  $\overline{\text{IRQ}}$  pin is at logic 0. A reset will clear the latch and the MODE control bit, thereby clearing the interrupt even if the pin stays low.

If the MODE bit is clear, the  $\overline{\text{IRQ}}$  pin is falling-edge-sensitive only. With MODE clear, a vector fetch or software clear immediately clears the IRQ latch.

The IRQF bit in the INTSCR register can be used to check for pending interrupts. The IRQF bit is not affected by the IMASK bit, which makes it useful in applications where polling is preferred.

Use the BIH or BIL instruction to read the logic level on the  $\overline{\text{IRQ}}$  pin.

**NOTE:** *When using the level-sensitive interrupt trigger, avoid false interrupts by masking interrupt requests in the interrupt routine.*

## 20.5 IRQ Status and Control Register (INTSCR)

The IRQ status and control register (INTSCR) controls and monitors operation of the IRQ module. The INTSCR has the following functions:

- Shows the state of the IRQ flag
- Clears the IRQ latch
- Masks IRQ interrupt request
- Controls triggering sensitivity of the  $\overline{\text{IRQ}}$  interrupt pin

Address: \$001E

	Bit 7	6	5	4	3	2	1	Bit 0
Read:	0	0	0	0	IRQF	0	IMASK	MODE
Write:						ACK		
Reset:	0	0	0	0	0	0	0	0

= Unimplemented

**Figure 20-3. IRQ Status and Control Register (INTSCR)**

### IRQF — IRQ Flag

This read-only status bit is high when the IRQ interrupt is pending.

- 1 = IRQ interrupt pending
- 0 = IRQ interrupt not pending

### ACK — IRQ Interrupt Request Acknowledge Bit

Writing a logic 1 to this write-only bit clears the IRQ latch. ACK always reads as logic 0. Reset clears ACK.

### IMASK — IRQ Interrupt Mask Bit

Writing a logic 1 to this read/write bit disables IRQ interrupt requests. Reset clears IMASK.

- 1 = IRQ interrupt requests disabled
- 0 = IRQ interrupt requests enabled

### MODE — IRQ Edge/Level Select Bit

This read/write bit controls the triggering sensitivity of the  $\overline{\text{IRQ}}$  pin. Reset clears MODE.

- 1 = IRQ interrupt requests on falling edges and low levels
- 0 = IRQ interrupt requests on falling edges only

### 20.6 IRQ Module During Break Interrupts

The system integration module (SIM) controls whether the IRQ latch can be cleared during the break state. The BCFE bit in the break flag control register (BFCR) enables software to clear the latches during the break state. (See [Section 9. System Integration Module \(SIM\)](#).)

To allow software to clear the IRQ latch during a break interrupt, write a logic 1 to the BCFE bit. If a latch is cleared during the break state, it remains cleared when the MCU exits the break state.

To protect the latches during the break state, write a logic 0 to the BCFE bit. With BCFE at logic 0 (its default state), writing to the ACK bit in the IRQ status and control register during the break state has no effect on the IRQ latch.



## Section 21. Keyboard Interrupt Module (KBI)

### 21.1 Contents

21.2	Introduction	321
21.3	Features	322
21.4	I/O Pins	322
21.5	Functional Description	323
21.6	Keyboard Initialization	325
21.7	I/O Registers	325
21.7.1	Keyboard Status and Control Register	326
21.7.2	Keyboard Interrupt Enable Register	327
21.8	Low-Power Modes	327
21.8.1	Wait Mode	327
21.8.2	Stop Mode	327
21.9	Keyboard Module During Break Interrupts	328

### 21.2 Introduction

The keyboard interrupt module (KBI) provides eight independently maskable external interrupts which are accessible via PTA0–PTA7. When a port pin is enabled for keyboard interrupt function, an internal pull-up device is also enabled on the pin.

## 21.3 Features

Features of the keyboard interrupt module (KBI) include:

- Eight keyboard interrupt pins with pull-up devices
- Separate keyboard interrupt enable bits and one keyboard interrupt mask
- Programmable edge-only or edge- and level- interrupt sensitivity
- Exit from low-power modes

Addr.	Register Name		Bit 7	6	5	4	3	2	1	Bit 0
\$004E	Keyboard Status and Control Register (KBSCR)	Read:	0	0	0	0	KEYF	0	IMASKK	MODEK
		Write:	[Unimplemented]							
		Reset:	0	0	0	0	0	0	0	0
\$004F	Keyboard Interrupt Enable Register (KBIER)	Read:	KBIE7	KBIE6	KBIE5	KBIE4	KBIE3	KBIE2	KBIE1	KBIE0
		Write:	[Unimplemented]							
		Reset:	0	0	0	0	0	0	0	0

[Unimplemented] = Unimplemented

**Figure 21-1. KBI I/O Register Summary**

## 21.4 I/O Pins

The eight keyboard interrupt pins are shared with standard port I/O pins. The full name of the KBI pins are listed in [Table 21-1](#). The generic pin name appear in the text that follows.

**Table 21-1. Pin Name Conventions**

KBI Generic Pin Name	Full MCU Pin Name	Pin Selected for KBI Function by KBIEx Bit in KBIER
KBI0–KBI7	PTA0/KBI0–PTA7/KBI7	KBIE0–KBIE7

## 21.5 Functional Description

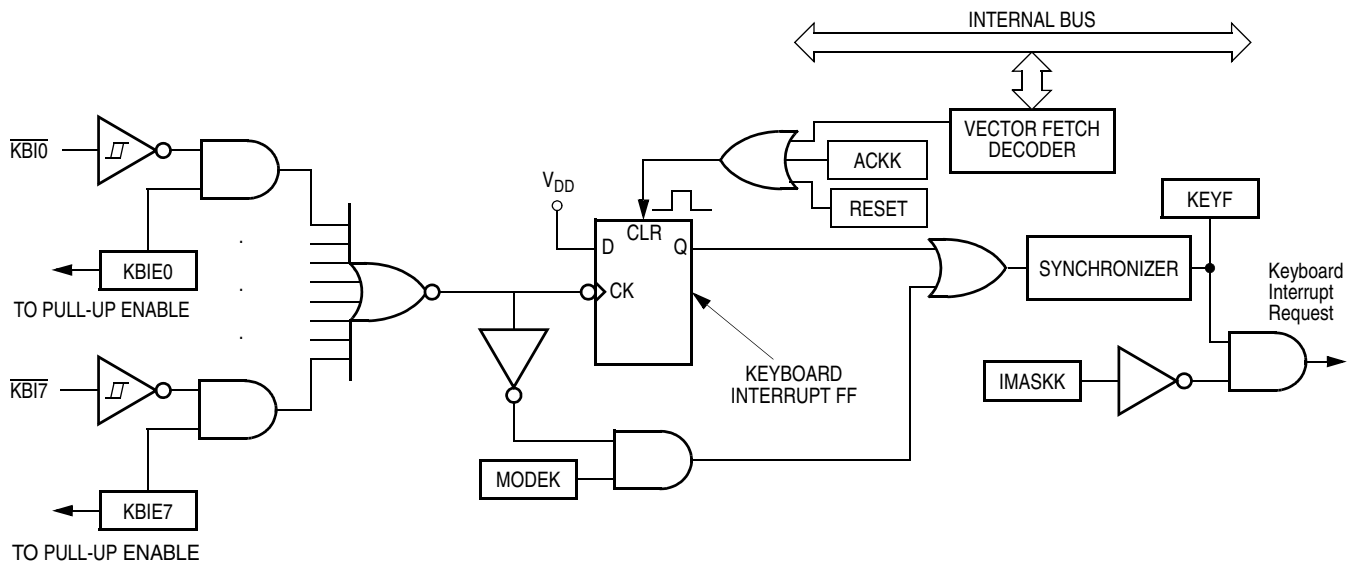

**Figure 21-2. Keyboard Interrupt Module Block Diagram**

Writing to the KBIE7–KBIE0 bits in the keyboard interrupt enable register independently enables or disables each port A pin as a keyboard interrupt pin. Enabling a keyboard interrupt pin also enables its internal pull-up device. A logic 0 applied to an enabled keyboard interrupt pin latches a keyboard interrupt request.

A keyboard interrupt is latched when one or more keyboard pins goes low after all were high. The MODEK bit in the keyboard status and control register controls the triggering mode of the keyboard interrupt.

- If the keyboard interrupt is edge-sensitive only, a falling edge on a keyboard pin does not latch an interrupt request if another keyboard pin is already low. To prevent losing an interrupt request on one pin because another pin is still low, software can disable the latter pin while it is low.
- If the keyboard interrupt is falling edge- and low level-sensitive, an interrupt request is present as long as any keyboard pin is low.

If the MODEK bit is set, the keyboard interrupt pins are both falling edge- and low level-sensitive, and both of the following actions must occur to clear a keyboard interrupt request:

- Vector fetch or software clear — A vector fetch generates an interrupt acknowledge signal to clear the interrupt request. Software may generate the interrupt acknowledge signal by writing a logic 1 to the ACKK bit in the keyboard status and control register (KBSCR). The ACKK bit is useful in applications that poll the keyboard interrupt pins and require software to clear the keyboard interrupt request. Writing to the ACKK bit prior to leaving an interrupt service routine also can prevent spurious interrupts due to noise. Setting ACKK does not affect subsequent transitions on the keyboard interrupt pins. A falling edge that occurs after writing to the ACKK bit latches another interrupt request. If the keyboard interrupt mask bit, IMASKK, is clear, the CPU loads the program counter with the vector address at locations \$FFE2 and \$FFE3.
- Return of all enabled keyboard interrupt pins to logic 1 — As long as any enabled keyboard interrupt pin is at logic 0, the keyboard interrupt remains set.

The vector fetch or software clear and the return of all enabled keyboard interrupt pins to logic 1 may occur in any order.

If the MODEK bit is clear, the keyboard interrupt pin is falling-edge-sensitive only. With MODEK clear, a vector fetch or software clear immediately clears the keyboard interrupt request.

Reset clears the keyboard interrupt request and the MODEK bit, clearing the interrupt request even if a keyboard interrupt pin stays at logic 0.

The keyboard flag bit (KEYF) in the keyboard status and control register can be used to see if a pending interrupt exists. The KEYF bit is not affected by the keyboard interrupt mask bit (IMASKK) which makes it useful in applications where polling is preferred.

To determine the logic level on a keyboard interrupt pin, use the data direction register to configure the pin as an input and read the data register.

**NOTE:** *Setting a keyboard interrupt enable bit (KBIE<sub>x</sub>) forces the corresponding keyboard interrupt pin to be an input, overriding the data direction register. However, the data direction register bit must be a logic 0 for software to read the pin.*

## 21.6 Keyboard Initialization

When a keyboard interrupt pin is enabled, it takes time for the pull-up device to reach a logic 1. Therefore, a false interrupt can occur as soon as the pin is enabled.

To prevent a false interrupt on keyboard initialization:

1. Mask keyboard interrupts by setting the IMASKK bit in the keyboard status and control register.
2. Enable the KBI pins by setting the appropriate KBIEEx bits in the keyboard interrupt enable register.
3. Write to the ACKK bit in the keyboard status and control register to clear any false interrupts.
4. Clear the IMASKK bit.

An interrupt signal on an edge-triggered pin can be acknowledged immediately after enabling the pin. An interrupt signal on an edge- and level-triggered interrupt pin must be acknowledged after a delay that depends on the external load.

Another way to avoid a false interrupt:

1. Configure the keyboard pins as outputs by setting the appropriate DDRA bits in data direction register A.
2. Write logic 1s to the appropriate port A data register bits.
3. Enable the KBI pins by setting the appropriate KBIEEx bits in the keyboard interrupt enable register.

## 21.7 I/O Registers

These registers control and monitor operation of the keyboard module:

- Keyboard status and control register (KBSCR)
- Keyboard interrupt enable register (KBIER)

## 21.7.1 Keyboard Status and Control Register

- Flags keyboard interrupt requests
- Acknowledges keyboard interrupt requests
- Masks keyboard interrupt requests
- Controls keyboard interrupt triggering sensitivity

Address: \$004E

	Bit 7	6	5	4	3	2	1	Bit 0
Read:	0	0	0	0	KEYF	0	IMASKK	MODEK
Write:						ACKK		
Reset:	0	0	0	0	0	0	0	0

 = Unimplemented

**Figure 21-3. Keyboard Status and Control Register (KBSCR)**

### KEYF — Keyboard Flag Bit

This read-only bit is set when a keyboard interrupt is pending. Reset clears the KEYF bit.

- 1 = Keyboard interrupt pending
- 0 = No keyboard interrupt pending

### ACKK — Keyboard Acknowledge Bit

Writing a logic 1 to this write-only bit clears the keyboard interrupt request. ACKK always reads as logic 0. Reset clears ACKK.

### IMASKK — Keyboard Interrupt Mask Bit

Writing a logic 1 to this read/write bit prevents the output of the keyboard interrupt mask from generating interrupt requests. Reset clears the IMASKK bit.

- 1 = Keyboard interrupt requests masked
- 0 = Keyboard interrupt requests not masked

### MODEK — Keyboard Triggering Sensitivity Bit

This read/write bit controls the triggering sensitivity of the keyboard interrupt pins. Reset clears MODEK.

- 1 = Keyboard interrupt requests on falling edges and low levels
- 0 = Keyboard interrupt requests on falling edges only

## 21.7.2 Keyboard Interrupt Enable Register

The keyboard interrupt enable register enables or disables each port A pin to operate as a keyboard interrupt pin.

Address: \$004F

	Bit 7	6	5	4	3	2	1	Bit 0
Read:	KBIE7	KBIE6	KBIE5	KBIE4	KBIE3	KBIE2	KBIE1	KBIE0
Write:								
Reset:	0	0	0	0	0	0	0	0

**Figure 21-4. Keyboard Interrupt Enable Register (KBIER)**

KBIE7–KBIE0 — Keyboard Interrupt Enable Bits

Each of these read/write bits enables the corresponding keyboard interrupt pin to latch interrupt requests. Reset clears the keyboard interrupt enable register.

1 = PTAx/KBIx pin enabled as keyboard interrupt pin

0 = PTAx/KBIx pin not enabled as keyboard interrupt pin

## 21.8 Low-Power Modes

The WAIT and STOP instructions put the MCU in low-power-consumption standby modes.

### 21.8.1 Wait Mode

The keyboard interrupt module remains active in wait mode. Clearing the IMASKK bit in the keyboard status and control register enables keyboard interrupt requests to bring the MCU out of wait mode.

### 21.8.2 Stop Mode

The keyboard interrupt module remains active in stop mode. Clearing the IMASKK bit in the keyboard status and control register enables keyboard interrupt requests to bring the MCU out of stop mode.

### 21.9 Keyboard Module During Break Interrupts

The system integration module (SIM) controls whether the keyboard interrupt latch can be cleared during the break state. The BCFE bit in the break flag control register (BFCR) enables software to clear status bits during the break state.

To allow software to clear the keyboard interrupt latch during a break interrupt, write a logic 1 to the BCFE bit. If a latch is cleared during the break state, it remains cleared when the MCU exits the break state.

To protect the latch during the break state, write a logic 0 to the BCFE bit. With BCFE at logic 0 (its default state), writing to the keyboard acknowledge bit (ACKK) in the keyboard status and control register during the break state has no effect. (See [21.7.1 Keyboard Status and Control Register](#).)



## Section 22. Computer Operating Properly (COP)

### 22.1 Contents

22.2	Introduction	329
22.3	Functional Description	330
22.4	I/O Signals	331
22.4.1	OSCCLK	331
22.4.2	STOP Instruction	331
22.4.3	COPCTL Write	331
22.4.4	Power-On Reset	331
22.4.5	Internal Reset	332
22.4.6	Reset Vector Fetch	332
22.4.7	COPD (COP Disable)	332
22.4.8	COPRS (COP Rate Select)	332
22.5	COP Control Register	333
22.6	Interrupts	333
22.7	Monitor Mode	333
22.8	Low-Power Modes	333
22.8.1	Wait Mode	334
22.8.2	Stop Mode	334
22.9	COP Module During Break Mode	334

### 22.2 Introduction

The computer operating properly (COP) module contains a free-running counter that generates a reset if allowed to overflow. The COP module helps software recover from runaway code. Prevent a COP reset by clearing the COP counter periodically. The COP module can be disabled through the COPD bit in the CONFIG register.

## 22.3 Functional Description

Figure 22-1 shows the structure of the COP module.

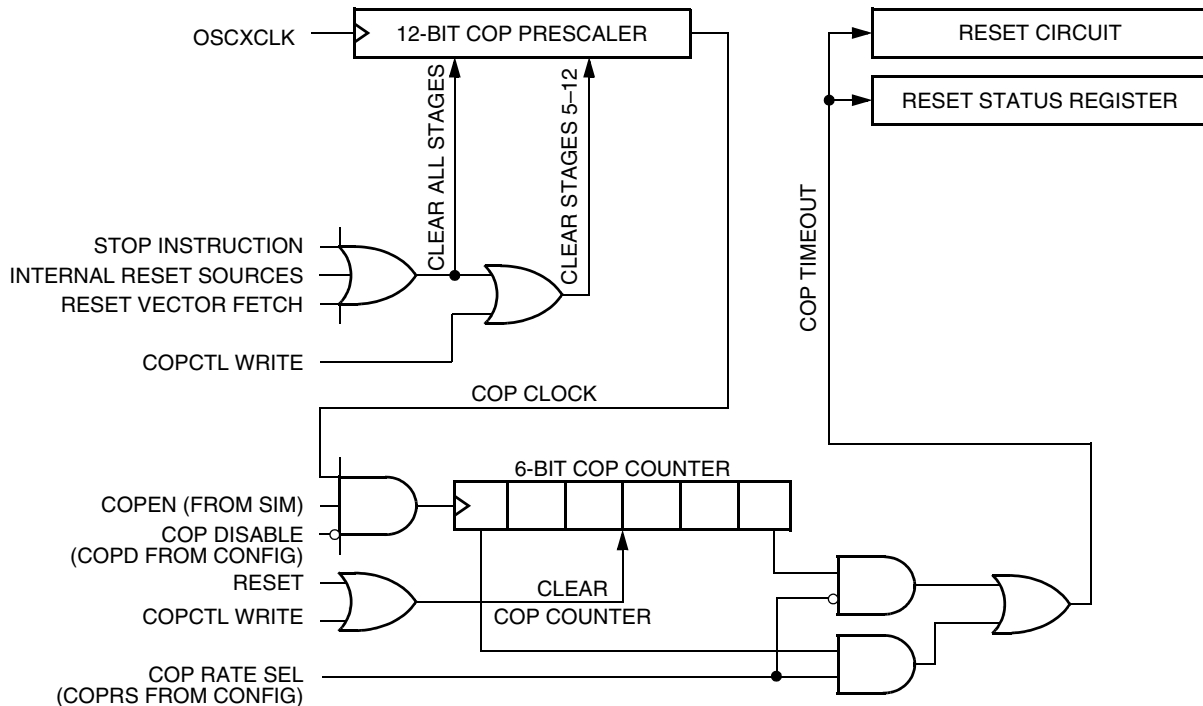

**Figure 22-1. COP Block Diagram**

The COP counter is a free-running 6-bit counter preceded by a 12-bit prescaler counter. If not cleared by software, the COP counter overflows and generates an asynchronous reset after  $2^{18} - 2^4$  or  $2^{13} - 2^4$  OSCXCLK cycles, depending on the state of the COP rate select bit, COPRS, in configuration register 1. With a  $2^{18} - 2^4$  OSCXCLK cycle overflow option, a 24MHz crystal gives a COP timeout period of 10.922ms. Writing any value to location \$FFFF before an overflow occurs prevents a COP reset by clearing the COP counter and stages 12 through 5 of the prescaler.

**NOTE:** Service the COP immediately after reset and before entering or after exiting stop mode to guarantee the maximum time before the first COP counter overflow.

A COP reset pulls the  $\overline{\text{RST}}$  pin low for 32 OSCXCLK cycles and sets the COP bit in the SIM reset status register (SRSR).

In monitor mode, the COP is disabled if the  $\overline{\text{RST}}$  pin or the  $\overline{\text{IRQ}}$  is held at  $V_{\text{TST}}$ . During the break state,  $V_{\text{TST}}$  on the  $\overline{\text{RST}}$  pin disables the COP.

**NOTE:** *Place COP clearing instructions in the main program and not in an interrupt subroutine. Such an interrupt subroutine could keep the COP from generating a reset even while the main program is not working properly.*

## 22.4 I/O Signals

The following paragraphs describe the signals shown in [Figure 22-1](#).

### 22.4.1 OSCXCLK

OSCXCLK is the crystal oscillator output signal. OSCXCLK frequency is equal to the crystal frequency.

### 22.4.2 STOP Instruction

The STOP instruction clears the COP prescaler.

### 22.4.3 COPCTL Write

Writing any value to the COP control register (COPCTL) (see [22.5 COP Control Register](#)) clears the COP counter and clears bits 12 through 5 of the prescaler. Reading the COP control register returns the low byte of the reset vector.

### 22.4.4 Power-On Reset

The power-on reset (POR) circuit clears the COP prescaler 4096 OSCXCLK cycles after power-up.

## 22.4.5 Internal Reset

An internal reset clears the COP prescaler and the COP counter.

## 22.4.6 Reset Vector Fetch

A reset vector fetch occurs when the vector address appears on the data bus. A reset vector fetch clears the COP prescaler.

## 22.4.7 COPD (COP Disable)

The COPD signal reflects the state of the COP disable bit (COPD) in the CONFIG register. (See [Figure 22-2](#).)

## 22.4.8 COPRS (COP Rate Select)

The COPRS signal reflects the state of the COP rate select bit (COPRS) in the CONFIG register. (See [Figure 22-2](#).)

Address: \$001F

	Bit 7	6	5	4	3	2	1	Bit 0
Read:	0	0	0	0	SSREC	COPRS	STOP	COPD
Write:								
Reset:	0	0	0	0	0	0	0	0

= Unimplemented

**Figure 22-2. Configuration Register (CONFIG)**

### COPRS — COP Rate Select Bit

COPRS selects the COP timeout period. Reset clears COPRS.

1 = COP timeout period is  $2^{13} - 2^4$  OSCXCLK cycles

0 = COP timeout period is  $2^{18} - 2^4$  OSCXCLK cycles

### COPD — COP Disable Bit

COPD disables the COP module.

1 = COP module disabled

0 = COP module enabled

## 22.5 COP Control Register

The COP control register is located at address \$FFFF and overlaps the reset vector. Writing any value to \$FFFF clears the COP counter and starts a new timeout period. Reading location \$FFFF returns the low byte of the reset vector.

Address:	\$FFFF
	Bit 7      6      5      4      3      2      1      Bit 0
Read:	Low byte of reset vector
Write:	Clear COP counter
Reset:	Unaffected by reset

**Figure 22-3. COP Control Register (COPCTL)**

## 22.6 Interrupts

The COP does not generate CPU interrupt requests.

## 22.7 Monitor Mode

When monitor mode is entered with  $V_{TST}$  on the  $\overline{IRQ}$  pin, the COP is disabled as long as  $V_{TST}$  remains on the  $\overline{IRQ}$  pin or the  $\overline{RST}$  pin. When monitor mode is entered by having blank reset vectors and not having  $V_{TST}$  on the  $\overline{IRQ}$  pin, the COP is automatically disabled until a POR occurs.

## 22.8 Low-Power Modes

The WAIT and STOP instructions put the MCU in low power-consumption standby modes.

### 22.8.1 Wait Mode

The COP remains active during wait mode. To prevent a COP reset during wait mode, periodically clear the COP counter in a CPU interrupt routine.

### 22.8.2 Stop Mode

Stop mode turns off the OSCXCLK input to the COP and clears the COP prescaler. Service the COP immediately before entering or after exiting stop mode to ensure a full COP timeout period after entering or exiting stop mode.

To prevent inadvertently turning off the COP with a STOP instruction, a configuration option is available that disables the STOP instruction. When the STOP bit in the configuration register has the STOP instruction is disabled, execution of a STOP instruction results in an illegal opcode reset.

## 22.9 COP Module During Break Mode

The COP is disabled during a break interrupt when  $V_{TST}$  is present on the  $\overline{RST}$  pin.

## Section 23. Break Module (BRK)

### 23.1 Contents

23.2	Introduction . . . . .	335
23.3	Features . . . . .	336
23.4	Functional Description . . . . .	336
23.4.1	Flag Protection During Break Interrupts . . . . .	338
23.4.2	CPU During Break Interrupts . . . . .	338
23.4.3	TIM During Break Interrupts . . . . .	338
23.4.4	COP During Break Interrupts . . . . .	338
23.5	Low-Power Modes . . . . .	338
23.5.1	Wait Mode . . . . .	338
23.5.2	Stop Mode . . . . .	339
23.6	Break Module Registers . . . . .	339
23.6.1	Break Status and Control Register . . . . .	339
23.6.2	Break Address Registers . . . . .	340
23.6.3	SIM Break Status Register . . . . .	340
23.6.4	SIM Break Flag Control Register . . . . .	342

### 23.2 Introduction

This section describes the break module. The break module can generate a break interrupt that stops normal program flow at a defined address to enter a background program.

### 23.3 Features

Features of the break module include:

- Accessible input/output (I/O) registers during the break interrupt
- CPU-generated break interrupts
- Software-generated break interrupts
- COP disabling during break interrupts

### 23.4 Functional Description

When the internal address bus matches the value written in the break address registers, the break module issues a breakpoint signal to the CPU. The CPU then loads the instruction register with a software interrupt instruction (SWI) after completion of the current CPU instruction. The program counter vectors to \$FFFC and \$FFFD (\$FEFC and \$FEFD in monitor mode).

The following events can cause a break interrupt to occur:

- A CPU-generated address (the address in the program counter) matches the contents of the break address registers.
- Software writes a logic 1 to the BRKA bit in the break status and control register.

When a CPU-generated address matches the contents of the break address registers, the break interrupt begins after the CPU completes its current instruction. A return-from-interrupt instruction (RTI) in the break routine ends the break interrupt and returns the MCU to normal operation. [Figure 23-1](#) shows the structure of the break module.



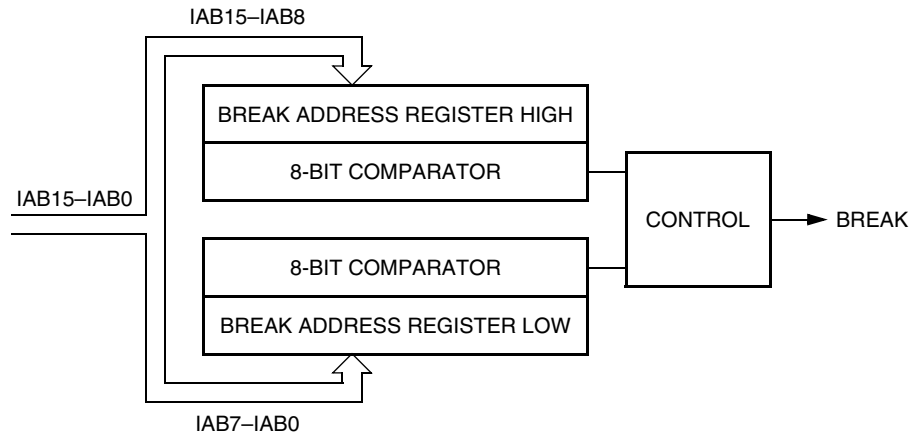

**Figure 23-1. Break Module Block Diagram**

Addr.	Register Name	Bit 7	6	5	4	3	2	1	Bit 0	
\$FE00	SIM Break Status Register (SBSR)	Read:	R	R	R	R	R	SBSW	R	
		Write:						Note		
		Reset:							0	
\$FE03	SIM Break Flag Control Register (SBFCR)	Read:	BCFE	R	R	R	R	R	R	
		Write:								
		Reset:	0							
\$FE0C	Break Address Register High (BRKH)	Read:	Bit 15	14	13	12	11	10	9	Bit 8
		Write:								
		Reset:	0	0	0	0	0	0	0	0
\$FE0D	Break Address Register Low (BRKL)	Read:	Bit 7	6	5	4	3	2	1	Bit 0
		Write:								
		Reset:	0	0	0	0	0	0	0	0
\$FE0E	Break Status and Control Register (BRKSCR)	Read:	BRKE	BRKA	0	0	0	0	0	0
		Write:								
		Reset:	0	0	0	0	0	0	0	0

Note: Writing a logic 0 clears SBSW.  = Unimplemented R = Reserved

**Figure 23-2. Break Module I/O Register Summary**

### 23.4.1 Flag Protection During Break Interrupts

The BCFE bit in the SIM break flag control register (SBFCR) enables software to clear status bits during the break state.

### 23.4.2 CPU During Break Interrupts

The CPU starts a break interrupt by:

- Loading the instruction register with the SWI instruction
- Loading the program counter with \$FFFC and \$FFFD (\$FEFC and \$FEFD in monitor mode)

The break interrupt begins after completion of the CPU instruction in progress. If the break address register match occurs on the last cycle of a CPU instruction, the break interrupt begins immediately.

### 23.4.3 TIM During Break Interrupts

A break interrupt stops the timer counters.

### 23.4.4 COP During Break Interrupts

The COP is disabled during a break interrupt when  $V_{TST}$  is present on the  $\overline{RST}$  pin.

## 23.5 Low-Power Modes

The WAIT and STOP instructions put the MCU in low power-consumption standby modes.

### 23.5.1 Wait Mode

If enabled, the break module is active in wait mode. In the break routine, the user can subtract one from the return address on the stack if SBSW is set (see [Section 9. System Integration Module \(SIM\)](#)). Clear the SBSW bit by writing logic 0 to it.

## 23.5.2 Stop Mode

A break interrupt causes exit from stop mode and sets the SBSW bit in the break status register.

## 23.6 Break Module Registers

These registers control and monitor operation of the break module:

- Break status and control register (BRKSCR)
- Break address register high (BRKH)
- Break address register low (BRKL)
- SIM break status register (SBSR)
- SIM break flag control register (SBFCR)

### 23.6.1 Break Status and Control Register

The break status and control register (BRKSCR) contains break module enable and status bits.

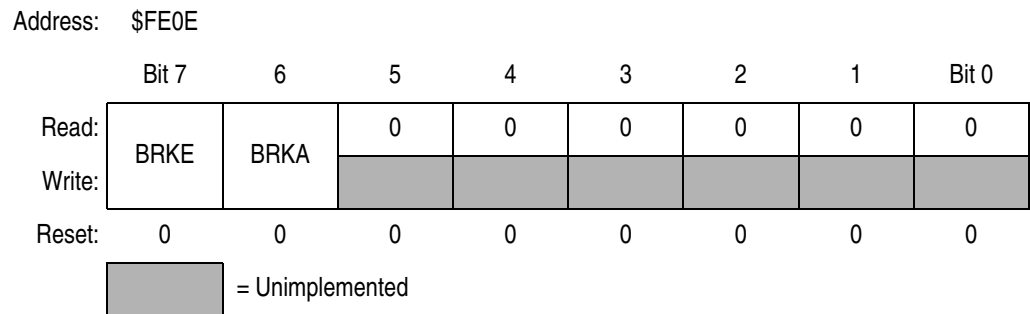

**Figure 23-3. Break Status and Control Register (BRKSCR)**

#### BRKE — Break Enable Bit

This read/write bit enables breaks on break address register matches. Clear BRKE by writing a logic 0 to bit 7. Reset clears the BRKE bit.

1 = Breaks enabled on 16-bit address match

0 = Breaks disabled on 16-bit address match

## BRKA — Break Active Bit

This read/write status and control bit is set when a break address match occurs. Writing a logic 1 to BRKA generates a break interrupt. Clear BRKA by writing a logic 0 to it before exiting the break routine. Reset clears the BRKA bit.

- 1 = (When read) Break address match
- 0 = (When read) No break address match

## 23.6.2 Break Address Registers

The break address registers (BRKH and BRKL) contain the high and low bytes of the desired breakpoint address. Reset clears the break address registers.

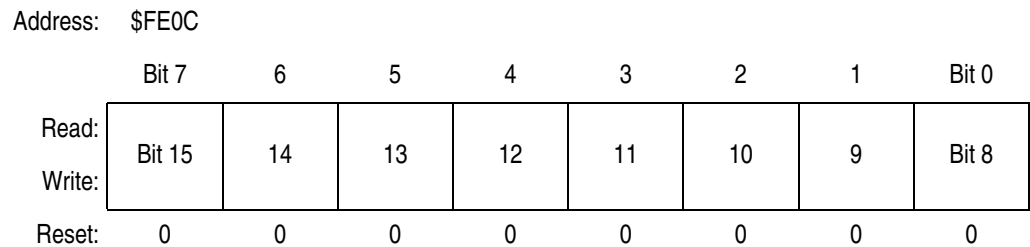

**Figure 23-4. Break Address Register High (BRKH)**

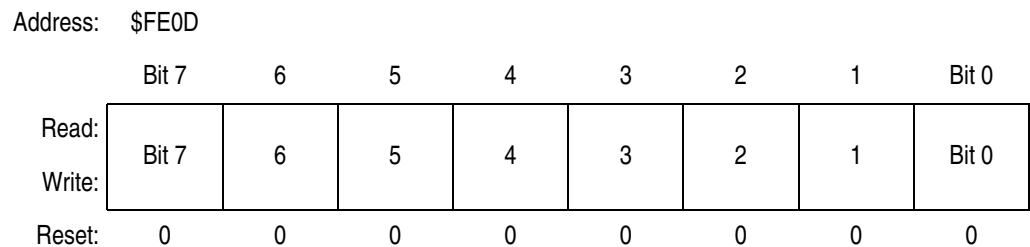

**Figure 23-5. Break Address Register Low (BRKL)**

## 23.6.3 SIM Break Status Register

The SIM break status register (SBSR) contains a flag to indicate that a break caused an exit from wait mode. The flag is useful in applications requiring a return to wait mode after exiting from a break interrupt.

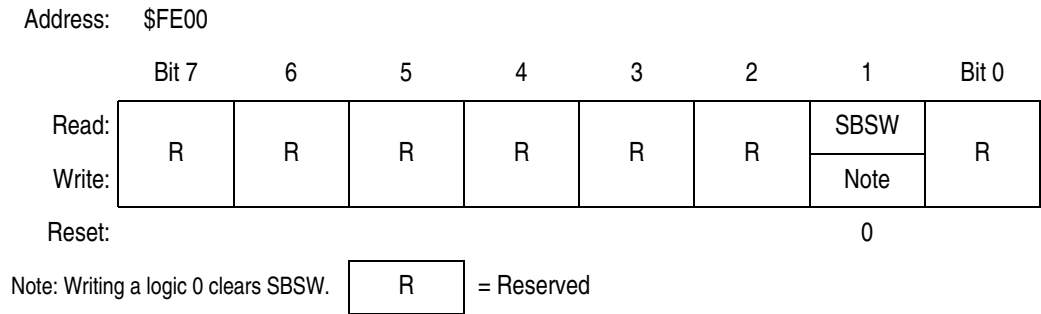

**Figure 23-6. SIM Break Status Register (SBSR)**

**SBSW — SIM Break Stop/Wait Bit**

This status bit is useful in applications requiring a return to wait or stop mode after exiting from a break interrupt. Clear SBSW by writing a logic 0 to it. Reset clears SBSW.

- 1 = Stop mode or wait mode was exited by break interrupt
- 0 = Stop mode or wait mode was not exited by break interrupt

SBSW can be read within the break interrupt routine. The user can modify the return address on the stack by subtracting one from it. The following code is an example.

```

;This code works if the H register has been pushed onto the stack in the break
;service routine software. This code should be executed at the end of the break
;service routine software.

HIBYTE EQU 5
LOBYTE EQU 6
; If not SBSW, do RTI
BRCLR SBSW,SBSR, RETURN ;See if wait mode or stop mode was exited by
;break.
TST LOBYTE,SP ;If RETURNLO is not zero,
BNE DOLO ;then just decrement low byte.
DEC HIBYTE,SP ;Else deal with high byte, too.
DOLO DEC LOBYTE,SP ;Point to WAIT/STOP opcode.
RETURN PULH ;Restore H register.
RTI

```

## 23.6.4 SIM Break Flag Control Register

The SIM break flag control register (SBFCR) contains a bit that enables software to clear status bits while the MCU is in a break state.

Address: \$FE03

	Bit 7	6	5	4	3	2	1	Bit 0
Read:	BCFE	R	R	R	R	R	R	R
Write:	BCFE	R	R	R	R	R	R	R
Reset:	0							

R = Reserved

**Figure 23-7. SIM Break Flag Control Register (SBFCR)**

### BCFE — Break Clear Flag Enable Bit

This read/write bit enables software to clear status bits by accessing status registers while the MCU is in a break state. To clear status bits during the break state, the BCFE bit must be set.

1 = Status bits clearable during break

0 = Status bits not clearable during break

## Section 24. Electrical Specifications

### 24.1 Contents

24.2	Introduction . . . . .	344
24.3	Absolute Maximum Ratings . . . . .	344
24.4	Functional Operating Range . . . . .	345
24.5	Thermal Characteristics . . . . .	345
24.6	DC Electrical Characteristics . . . . .	346
24.7	Control Timing . . . . .	347
24.8	Timer Interface Module Characteristics . . . . .	347
24.9	Oscillator Characteristics . . . . .	347
24.10	ADC Electrical Characteristics . . . . .	348
24.11	Sync Processor Timing . . . . .	349
24.12	USB DC Electrical Characteristics . . . . .	349
24.12.1	USB Low Speed Source Electrical Characteristics . . . . .	350
24.12.2	USB High Speed Source Electrical Characteristics . . . . .	351
24.12.3	HUB Repeater Electrical Characteristics . . . . .	352
24.12.4	USB Signaling Levels . . . . .	353
24.13	DDC12AB/MMIIC Timing . . . . .	354
24.13.1	DDC12AB/MMIIC Interface Input Signal Timing . . . . .	354
24.13.2	DDC12AB/MMIIC Interface Output Signal Timing . . . . .	354
24.14	FLASH Memory Characteristics . . . . .	355

## 24.2 Introduction

This section contains electrical and timing specifications.

## 24.3 Absolute Maximum Ratings

Maximum ratings are the extreme limits to which the MCU can be exposed without permanently damaging it.

**NOTE:** *This device is not guaranteed to operate properly at the maximum ratings. Refer to [24.6 DC Electrical Characteristics](#) for guaranteed operating conditions.*

**Table 24-1. Absolute Maximum Ratings**

Characteristic <sup>(1)</sup>	Symbol	Value	Unit
Supply voltage	$V_{DD}$	-0.3 to +3.9	V
Input voltage	$V_{IN}$	$V_{SS}-0.3$ to $V_{DD}+0.3$	V
Input voltage, +5V pins IICSDA, IICSCSCL, DDCSDA, DCSCSCL, HSYNC, VSYNC, PHSYNC, PVSYN, PCLK	$V_{HIN}$	$V_{SS}-0.3$ to +5.5	V
Maximum current per pin excluding $V_{DD}$ and $V_{SS}$	I	±25	mA
Storage temperature	$T_{STG}$	-55 to +150	°C
Maximum current out of $V_{SS}$	$I_{MVSS}$	80	mA
Maximum current into $V_{DD}$	$I_{MVDD}$	80	mA

**Notes:**

1. Voltages referenced to  $V_{SS}$ .

**NOTE:** *This device contains circuitry to protect the inputs against damage due to high static voltages or electric fields; however, it is advised that normal precautions be taken to avoid application of any voltage higher than maximum-rated voltages to this high-impedance circuit. For proper operation, it is recommended that  $V_{IN}$  and  $V_{OUT}$  be constrained to the range  $V_{SS} \leq (V_{IN} \text{ or } V_{OUT}) \leq V_{DD}$ . Reliability of operation is enhanced if unused inputs are connected to an appropriate logic voltage level (for example, either  $V_{SS}$  or  $V_{DD}$ .)*



## 24.4 Functional Operating Range

**Table 24-2. Operating Range**

Characteristic	Symbol	Value	Unit
Operating temperature range	$T_A$	0 to +85	°C
Operating voltage range	$V_{DD}$	3.0 to 3.6	V

## 24.5 Thermal Characteristics

**Table 24-3. Thermal Characteristics**

Characteristic	Symbol	Value	Unit
Thermal resistance QFP (64 pins)	$\theta_{JA}$	70	°C/W
I/O pin power dissipation	$P_{I/O}$	User determined	W
Power dissipation <sup>(1)</sup>	$P_D$	$P_D = (I_{DD} \times V_{DD}) + P_{I/O} =$ $K/(T_J + 273 \text{ °C})$	W
Constant <sup>(2)</sup>	K	$P_D \times (T_A + 273 \text{ °C})$ $+ P_D^2 \times \theta_{JA}$	W/°C
Average junction temperature	$T_J$	$T_A + (P_D \times \theta_{JA})$	°C
Maximum junction temperature	$T_{JM}$	100	°C

**Notes:**

- Power dissipation is a function of temperature.
- K is a constant unique to the device. K can be determined for a known  $T_A$  and measured  $P_D$ . With this value of K,  $P_D$  and  $T_J$  can be determined for any value of  $T_A$ .

## 24.6 DC Electrical Characteristics

Table 24-4. DC Electrical Characteristics

Characteristic <sup>(1)</sup>	Symbol	Min	Typ <sup>(2)</sup>	Max	Unit
Output high voltage ( $I_{LOAD} = -2.0\text{mA}$ ) All output pins	$V_{OH}$	2.4	—	—	V
Output low voltage ( $I_{LOAD} = 1.6\text{mA}$ ) All output pins	$V_{OL}$	—	—	0.4	V
Input high voltage All ports (except PTD4–PTD7), $\overline{IRQ}$ , $\overline{RST}$ , OSC1 For +5V rated pins HSYNC, VSYNC, PHSYNC, PVSYN, PCLK, IICSDA, IICSC, DDCSDA, DDCSCL	$V_{IH}$	$0.7 \times V_{DD}$ 2.0	— —	$V_{DD}$ 5.5	V
Input low voltage All ports (except PTD4–PTD7), $\overline{IRQ}$ , $\overline{RST}$ , OSC1 For +5V rated pins HSYNC, VSYNC, PHSYNC, PVSYN, PCLK, IICSDA, IICSC, DDCSDA, DDCSCL	$V_{IL}$	$V_{SS}$ $V_{SS}$	— —	$0.2 \times V_{DD}$ 0.8	V
$V_{DD}$ supply current Run, USB active, PLL on, $f_{OP} = 6.0\text{MHz}$ <sup>(3)</sup> Run, USB suspended, PLL off, $f_{OP} = 6.0\text{MHz}$ <sup>(3)</sup> Wait, USB active, PLL on, $f_{OP} = 6.0\text{MHz}$ <sup>(4)</sup> Wait, USB suspended, PLL off, $f_{OP} = 6.0\text{MHz}$ <sup>(4)</sup> Stop <sup>(5)</sup> 0°C to +85°C	$I_{DD}$	— — — — —	11 9 6 4 100	20 16 12 8 200	mA mA mA mA μA
I/O ports Hi-Z leakage current	$I_{IL}$	—	—	±10	μA
Input current All input pins (except below pins) HSYNC, VSYNC, PHSYNC, PVSYN, PCLK	$I_{IN}$	— —	— —	±1 ±2	μA
Capacitance Ports (as input or output)	$C_{OUT}$ $C_{IN}$	— —	— —	12 8	pF
POR re-arm voltage <sup>(6)</sup>	$V_{POR}$	0	—	100	mV
POR rise time ramp rate <sup>(7)</sup>	$R_{POR}$	0.035	—	—	V/ms
Monitor mode entry voltage	$V_{TST}$	$V_{DD} + 1.7$	—	6	V
Pull-up resistor: KBI0–KBI7, $\overline{RST}$ , $\overline{IRQ}$	$R_{PU}$	30	45	60	kΩ
Low-voltage inhibit, trip falling voltage	$V_{TRIPF}$		2.45		V
Low-voltage inhibit, trip rising voltage	$V_{TRIPR}$		2.6		V
Low-voltage inhibit reset/recover hysteresis	$V_{HYS}$	—	150	—	mV

**Notes:**

- $V_{DD} = 3.0$  to  $3.6\text{Vdc}$ ,  $V_{SS} = 0\text{Vdc}$ ,  $T_A = T_L$  to  $T_H$ , unless otherwise noted.
- Typical values reflect average measurements at midpoint of voltage range, 25 °C only.
- Run (operating)  $I_{DD}$  measured using external square wave clock source. All inputs 0.2 V from rail. No dc loads. Less than 100 pF on all outputs.  $C_L = 20\text{pF}$  on OSC2. All ports configured as inputs. OSC2 capacitance linearly affects run  $I_{DD}$ . Measured with all modules enabled.
- Wait  $I_{DD}$  measured using external square wave clock source ( $f_{OSCCLK} = 24\text{MHz}$ ); all inputs 0.2 V from rail; no dc loads; less than 100 pF on all outputs.  $C_L = 20\text{pF}$  on OSC2; USB in suspend mode,  $15\text{k}\Omega \pm 5\%$  termination resistors on D+ and D– pins; all ports configured as inputs; OSC2 capacitance linearly affects wait  $I_{DD}$ .
- STOP  $I_{DD}$  measured with USB in suspend mode, OSC1 grounded,  $1.5\text{k}\Omega \pm 1\%$  pull-up resistor on D+ pin and  $15\text{k}\Omega \pm 1\%$  pull-down resistors on D+ and D– pins, no port pins sourcing current.
- Maximum is highest voltage that POR is guaranteed.
- If minimum  $V_{DD}$  is not reached before the internal POR reset is released,  $\overline{RST}$  must be driven low externally until minimum  $V_{DD}$  is reached.

## 24.7 Control Timing

**Table 24-5. Control Timing**

Characteristic <sup>(1)</sup>	Symbol	Min	Max	Unit
Internal operating frequency <sup>(2)</sup>	$f_{OP}$	—	6	MHz
$\overline{RST}$ input pulse width low <sup>(3)</sup>	$t_{IRL}$	50	—	ns

**Notes:**

- $V_{DD} = 3.0$  to  $3.6$  Vdc,  $V_{SS} = 0$  Vdc; timing shown with respect to 20%  $V_{DD}$  and 70%  $V_{DD}$ , unless otherwise noted.
- Some modules may require a minimum frequency greater than dc for proper operation; see appropriate table for this information.
- Minimum pulse width reset is guaranteed to be recognized. It is possible for a smaller pulse width to cause a reset.

## 24.8 Timer Interface Module Characteristics

**Table 24-6. TIM Characteristics**

Characteristic	Symbol	Min	Max	Unit
Input capture pulse width	$t_{TIH}, t_{TIL}$	125	—	ns
Input clock pulse width	$t_{TCH}, t_{TCL}$	$(1/f_{OP}) + 5$	—	ns

## 24.9 Oscillator Characteristics

**Table 24-7. Oscillator Characteristics**

Characteristic	Symbol	Min	Typ	Max	Unit
Crystal frequency <sup>(1)</sup>	$f_{OSCCLK}$	—	24	—	MHz
External clock Reference frequency <sup>(1), (2)</sup>	$f_{OSCCLK}$	dc	24	—	MHz
Crystal fixed capacitance <sup>(3)</sup>	$C_1$	—	15	—	pF
Crystal tuning capacitance <sup>(3)</sup>	$C_2$	—	15	—	pF
Feedback bias resistor	$R_B$	—	2	—	M $\Omega$
Series resistor <sup>(3)</sup>	$R_S$	—	0	—	$\Omega$

**Notes:**

- The sync processor module is designed to function at  $f_{OSCCLK} = 24$  MHz.
- No more than 10% duty cycle deviation from 50%
- Not Required for high frequency crystals

## 24.10 ADC Electrical Characteristics

**Table 24-8. ADC Electrical Characteristics**

Characteristic <sup>(1)</sup>	Symbol	Min	Max	Unit	Comments
Supply voltage	$V_{DDAD}$	3.0	3.6	V	$V_{DD} \pm 10\%$
Input voltages	$V_{ADIN}$	0	$V_{DD}$	V	
Resolution	$B_{AD}$	8	8	Bits	
Absolute accuracy	$A_{AD}$	$\pm 1$	$\pm 2$	LSB	Includes quantization
ADC internal clock	$f_{ADIC}$	0.5	1.048	MHz	$t_{AIC} = 1/f_{ADIC}$ , tested only at 1 MHz
Conversion range	$R_{AD}$	$V_{SS}$	$V_{DD}$	V	
Power-up time	$t_{ADPU}$	16		$t_{AIC}$ cycles	
Conversion time	$t_{ADC}$	16	17	$t_{AIC}$ cycles	
Sample time <sup>(2)</sup>	$t_{ADS}$	5	—	$t_{AIC}$ cycles	
Zero input reading <sup>(3)</sup>	$Z_{ADI}$	00	02	HEX	
Full-scale reading <sup>(3)</sup>	$F_{ADI}$	FD	FF	HEX	
Input capacitance	$C_{ADI}$	—	8	pF	Not tested
Input leakage <sup>(4)</sup> Port C	—	—	$\pm 1$	$\mu A$	

**Notes:**

- $V_{DD} = 3.0$  to  $3.6$  Vdc,  $V_{SS} = 0$  Vdc,  $T_A = T_L$  to  $T_H$ , unless otherwise noted.
- Source impedances greater than  $10\text{ k}\Omega$  adversely affect internal RC charging time during input sampling.
- Zero-input/full-scale reading requires sufficient decoupling measures for accurate conversions.
- The external system error caused by input leakage current is approximately equal to the product of R source and input current.

## 24.11 Sync Processor Timing

**Table 24-9. Sync Processor Timing**

Characteristic <sup>(1)</sup>	Symbol	Min	Max	Unit
VSYNC input sync pulse	$t_{VI.SP}$	8	2048	$\mu\text{s}$
HSYNC input sync pulse	$t_{HI.SP}$	0.1	6	$\mu\text{s}$
VSYNC to VSYNCO delay (8pF loading)	$t_{VVd}$	30	40	$\mu\text{s}$
HSYNC to HSYNCO delay (8pF loading)	$t_{HHd}$	30	40	$\mu\text{s}$
DE set-up time of DCLK	$t_{DESu}$	4	—	$\mu\text{s}$
DE hold time of DCLK	$t_{DEHd}$	4	—	$\mu\text{s}$

**Notes:**

- $V_{DD} = 3.0$  to  $3.6$  Vdc,  $V_{SS} = 0$  Vdc; timing shown with respect to 20%  $V_{DD}$  and 70%  $V_{DD}$ , unless otherwise noted.

## 24.12 USB DC Electrical Characteristics

**Table 24-10. USB DC Electrical Characteristics**

Characteristic <sup>(1)</sup>	Symbol	Conditions	Min	Typ	Max	Unit
Hi-Z state data line leakage	$I_{LO}$	$0V < V_{IN} < 3.3V$	-10		+10	$\mu\text{A}$
Differential input sensitivity	$V_{DI}$	$  (D+) - (D-)  $	0.2			V
Differential common mode range	$V_{CM}$	Includes $V_{DI}$ range	0.8		2.5	V
Single ended receiver threshold	$V_{SE}$		0.8		2.0	V
Static output low	$V_{OL}$	$R_L$ of 1.5k to 3.6V			0.3	V
Static output high	$V_{OH}$	$R_L$ of 15k to GND	2.8		3.6	V

**Notes:**

- $V_{DD} = 3.0$  to  $3.6$  Vdc,  $V_{SS} = 0$  Vdc,  $T_A = T_L$  to  $T_H$ , unless otherwise noted.

## 24.12.1 USB Low Speed Source Electrical Characteristics

**Table 24-11. USB Low Speed Source Electrical Characteristics**

Characteristic	Symbol	Conditions <sup>(1)</sup>	Min	Typ	Max	Unit
Internal operating frequency	$f_{OP}$			6		MHz
Transition time <sup>(2)</sup>						
Rise time	$T_R$	$C_L=200\text{pF}$	75	—	300	ns
Fall time	$T_F$	$C_L=600\text{pF}$	75	—	300	ns
		$C_L=200\text{pF}$				ns
		$C_L=600\text{pF}$				ns
Rise/Fall time matching	$T_{RFM}$	$T_R/T_F$	80	—	120	%
Output signal crossover voltage	$V_{CRS}$		1.3		2.0	V
Low speed data rate	$T_{DRATE}$	1.5Mbs $\pm$ 1.5%	1.4775 676.8	1.500 666.0	1.5225 656.8	Mbs ns
Source differential driver jitter						
To next transition	$T_{UDJ1}$	$C_L=350\text{pF}$	-25		25	ns
For paired transitions	$T_{UDJ2}$	Note <sup>(3), (4)</sup>	-10		10	ns
Receiver data jitter tolerance						
To next transition	$T_{DJR1}$	$C_L=350\text{pF}$	-75		75	ns
For paired transitions	$T_{DJR2}$	Notes <sup>(3), (4)</sup>	-45		45	ns
Source EOP width	TEOPT	Note <sup>(4)</sup>	1.25		1.50	$\mu\text{s}$
Differential to EOP transition skew	TDEOP	Note <sup>(4)</sup>	-40		100	ns
Receiver EOP width						
Must reject as EOP	$T_{EOPR1}$	Note <sup>(4)</sup>	330			ns
Must accept	$T_{EOPR2}$		675			ns

**Notes:**

1. All voltages measured from local ground, unless otherwise specified. All timings use a capacitive load of 50pF, unless otherwise specified. Low speed timings have a 1.5k $\Omega$  pull-up to 2.8V on the D- data line.
2. Transitions are measured from 10% to 90% of the data signal. The rising and falling edges should be smoothly transitioning (monotonic). Capacitive loading includes 50pF of tester capacitance.
3. Timing differences between the differential data signals.
4. Measured at crossover point of differential data signals.

## 24.12.2 USB High Speed Source Electrical Characteristics

**Table 24-12. USB High Speed Source Electrical Characteristics**

Characteristic	Symbol	Conditions <sup>(1)</sup>	Min	Typ	Max	Unit
Internal operating frequency	$f_{OP}$			6		MHz
Transition time <sup>(2)</sup>						
Rise time	$T_R$	$C_L=50pF$	4		20	ns
Fall time	$T_F$	$C_L=50pF$	4		20	ns
Rise/Fall time matching	$T_{RFM}$	$T_R/T_F$	90		110	%
Output signal crossover voltage	$V_{CRS}$		1.3		2.0	V
High speed data rate	$T_{DRATE}$	$12Mbs \pm 0.25\%$	11.97		12.03	Mbs
Frame interval	$T_{FRAME}$	$1.0ms \pm 0.05\%$	0.9995		1.0005	ms
Source differential driver jitter						
To next transition	$T_{DJ1}$	$C_L=50pF$	-3.5		3.5	ns
For paired transitions	$T_{DJ1}$	Notes <sup>(3)</sup> , <sup>(4)</sup>	-4.0		4.0	ns
Source EOP Width	$T_{EOPT}$	Note <sup>(4)</sup>	160		175	ns
Differential to EOP transition skew	$T_{DEOP}$	Note <sup>(4)</sup>	-2		5	ns
Receive data jitter tolerance						
To next transition	$T_{JR1}$	$C_L=50pF$	-18.5		18.5	ns
For paired transitions	$T_{JR2}$	Notes <sup>(3)</sup> , <sup>(4)</sup>	-9		9	ns
Receiver EOP width						
Must reject as EOP	$T_{EOPR1}$	Note <sup>(4)</sup>	40			ns
Must accept	$T_{EOPR2}$		82			ns

**Notes:**

1. All voltages measured from local ground, unless otherwise specified. All timings use a capacitive load of 50pF, unless otherwise specified. High speed timings have a 1.5kΩ pull-up to 2.8V on the D+ data line.
2. Transitions are measured from 10% to 90% of the data signal. The rising and falling edges should be smoothly transitioning (monotonic). Capacitive loading includes 50pF of tester capacitance.
3. Timing differences between the differential data signals.
4. Measured at crossover point of differential data signals.

## 24.12.3 HUB Repeater Electrical Characteristics

**Table 24-13. HUB Repeater Electrical Characteristics**

### Low Speed HUB Electrical Characteristics (Root port and downstream ports configured as low speed)

Characteristic	Symbol	Conditions Note <sup>(1),(2),(3)</sup>	Min	Typ	Max	Unit
HUB differential data delay	$T_{LHDD}$	Note <sup>(4),(5),(6)</sup>			300	ns
HUB differential driver jitter (including cable) Downstream: To next transition For paired transitions Upstream To next transition For paired transitions	$T_{LDHJ1}$ $T_{LDHJ2}$ $T_{LUHJ1}$ $T_{LUHJ2}$	Note <sup>(4),(5),(6)</sup>	-45 -15 45 45		45 15 45 45	ns ns ns ns
Data bit width distortion after EOP.	$T_{EOP}$	Note <sup>(4),(6)</sup>	-60		60	ns
HUB EOP delay relative to $T_{HDD}$	$T_{LEOPD}$	Note <sup>(4),(6)</sup>	0		200	ns
HUB EOP output width skew	$T_{LHESK}$	Note <sup>(4),(6)</sup>	-300		300	ns

### Full Speed HUB Electrical Characteristics (Root port and downstream ports configured as full speed)

Characteristic	Symbol	Conditions (Notes 1,2,3)	Min	Typ	Max	Unit
HUB differential data delay (with cable) (without cable)	$T_{HDD1}$ $T_{HDD1}$	Note <sup>(3),(5),(6)</sup>			70 40	ns ns
HUB differential driver jitter (including cable) To next transition For paired transitions	$T_{HDJ1}$ $T_{HDJ2}$	Note <sup>(3),(5),(6)</sup>	-3 -1		3 1	ns ns
Data bit width distortion after SOP	$T_{SOP}$	Note <sup>(3),(6)</sup>	-5		5	ns
HUB EOP delay relative to $T_{HDD}$	$T_{EOPD}$	Note <sup>(3),(6)</sup>	0		15	ns
HUB EOP output width skew	$T_{HESK}$	Note <sup>(3),(6)</sup>	-15		15	ns

**Notes:**

1. All voltages measured from local ground, unless otherwise specified.
2. All timings use a capacitive load of ( $C_L$ ) to ground of 50pF, unless otherwise specified.
3. Full speed timings have a 1.5k $\Omega$  pull-up to 2.8V on the D+ data line.
4. Low speed timings have a 1.5k $\Omega$  pull-up to 2.8V on the D- data line.
5. Timing differences between the differential data signals.
6. Measured at crossover point of differential data signals.  
Measured from 10% to 90% of the data signal.  
The rising and falling edges should be smoothly transitioning (monotonic).  
The maximum load specification is the maximum effective capacitive load allowed that meets the target HUB VBUS droop of 330mV.



## 24.12.4 USB Signaling Levels

**Table 24-14. USB Signaling Levels**

Bus State	Signaling Levels	
	From Originating Driver	At Receiver
Differential "1"	$(D+) - (D-) > 200 \text{ mV}$ and $D+$ or $D- > V_{SE}$ (min.)	
Differential "0"	$(D+) - (D-) < -200 \text{ mV}$ and $D+$ or $D- > V_{SE}$ (min.)	
Data J State: Low Speed Full Speed	Differential "0" Differential "1"	
Data K State: Low Speed Full Speed	Differential "1" Differential "0"	
Idle State: Low Speed Full Speed	Differential "0" and $D- > V_{SE}$ (max.) and $D+ < V_{SE}$ (min.) Differential "1" and $D+ > V_{SE}$ (max.) and $D- < V_{SE}$ (min.)	
Resume State: Low Speed Full Speed	Differential "1" and $D+ > V_{SE}$ (max.) and $D- < V_{SE}$ (min.) Differential "0" and $D- > V_{SE}$ (max.) and $D+ < V_{SE}$ (min.)	
Start of Packet (SOP)	Data lines switch from Idle to K State	
End of Packet (EOP)	$D+$ and $D- < V_{SE}$ (min) for 2 bit times <sup>(1)</sup> followed by an Idle for 1 bit time	$D+$ and $D- < V_{SE}$ (min) for $\geq 1$ bit time <sup>(2)</sup> followed by a J State
Disconnect (Upstream only)	—	$D+$ and $D- < V_{SE}$ (max) for $\geq 2.5 \mu\text{s}$
Connect (Upstream only)	—	$D+$ or $D- > V_{SE}$ (max) for $\geq 2.5 \mu\text{s}$
Reset (Downstream only)	$D+$ and $D- < V_{SE}$ for $\geq 10 \text{ ms}$	$D+$ and $D- < V_{SE}$ (min) for $\geq 2.5 \mu\text{s}$ (must be recognized within $5.5 \mu\text{s}$ ) <sup>(3)</sup>

**Notes:**

1. The width of EOP is defined in bit times relative to the speed of transmission.
2. The width of EOP is defined in bit times relative to the device type receiving the EOP.
3. These times apply to an active device that is not in the suspend state.

## 24.13 DDC12AB/MMIIC Timing

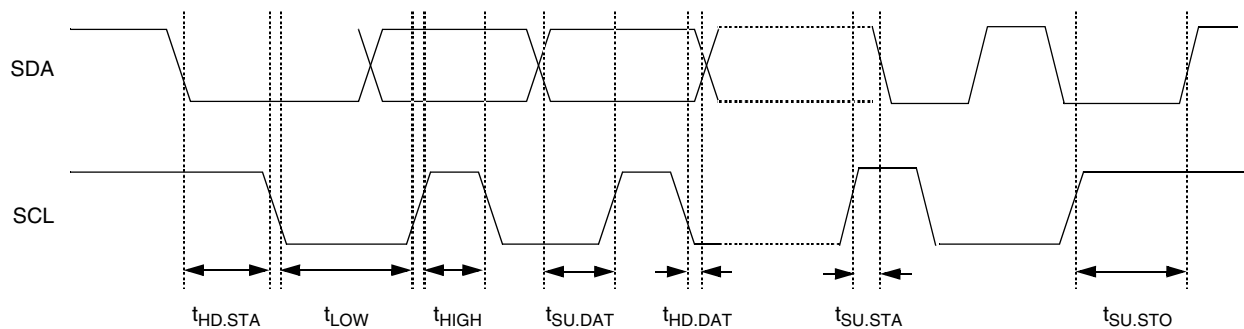

Figure 24-1. MMIIIC Signal Timings

### 24.13.1 DDC12AB/MMIIC Interface Input Signal Timing

Table 24-15. DDC12AB/MMIIC Interface Input Signal Timing

Characteristic <sup>(1)</sup>	Symbol	Min	Max	Unit
START condition hold time	$t_{HD.STA}$	2	—	$t_{CYC}$
Clock low period	$t_{LOW}$	4	—	$t_{CYC}$
Clock high period	$t_{HIGH}$	4	—	$t_{CYC}$
Data set-up time	$t_{SU.DAT}$	250	—	ns
Data hold time	$t_{HD.DAT}$	0	—	ns
START condition set-up time (for repeated START condition only)	$t_{SU.STA}$	2	—	$t_{CYC}$
STOP condition set-up time	$t_{SU.STO}$	2	—	$t_{CYC}$

**Notes:**

1.  $V_{DD} = 3.0$  to  $3.6$  Vdc,  $V_{SS} = 0$  Vdc; timing shown with respect to 20%  $V_{DD}$  and 70%  $V_{DD}$ , unless otherwise noted.

### 24.13.2 DDC12AB/MMIIC Interface Output Signal Timing

Table 24-16. DDC12AB/MMIIC Interface Output Signal Timing

Characteristic <sup>(1)</sup>	Symbol	Min	Max	Unit
SDA/SCL rise time <sup>(2)</sup>	$t_R$	—	1	$\mu s$
SDA/SCL fall time	$t_F$	—	300	ns
Data set-up time	$t_{SU.DAT}$	$t_{LOW}$	—	ns
Data hold time	$t_{HD.DAT}$	0	—	ns

**Notes:**

1.  $V_{DD} = 3.0$  to  $3.6$  Vdc,  $V_{SS} = 0$  Vdc; timing shown with respect to 20%  $V_{DD}$  and 70%  $V_{DD}$ , unless otherwise noted.

2. With 200pF loading on the SDA/SCL pins.

## 24.14 FLASH Memory Characteristics

**Table 24-17. FLASH Memory Electrical Characteristics**

Characteristic	Symbol	Min	Max	Unit
Program bus clock frequency	—	1	—	MHz
FLASH block size \$0C00–\$0FFF	—	128		Bytes
\$1000–F9FF	—	512		Bytes
FLASH programming size	—	64		Bytes
Read bus clock frequency	$f_{\text{Read}}^{(1)}$	32k	6M	Hz
Page erase time	$t_{\text{Erase}}^{(2)}$	10	—	ms
Mass erase time	$t_{\text{MErase}}^{(3)}$	10	—	ms
PGM/ERASE to HVEN set up time	$t_{\text{nvs}}$	5	—	$\mu\text{s}$
High-voltage hold time	$t_{\text{nvh}}$	5	—	$\mu\text{s}$
High-voltage hold time (mass erase)	$t_{\text{nvhl}}$	100	—	$\mu\text{s}$
Program hold time	$t_{\text{pgs}}$	20	—	ns
Program time	$t_{\text{PROG}}$	20	40	$\mu\text{s}$
Return to read time	$t_{\text{rcv}}^{(4)}$	1	—	$\mu\text{s}$
Cumulative program HV period 4,7616 bytes array	$t_{\text{HV}}^{(5)}$	—	6	ms
13K-bytes array	$t_{\text{HV1}}^{(6)}$	—	3	ms
Row erase endurance <sup>(7)</sup>	—	10k	—	Cycles
Row program endurance <sup>(8)</sup>	—	10k	—	Cycles
Data retention time <sup>(9)</sup>	—	10	—	Years

**Notes:**

- $f_{\text{READ}}$  is defined as the frequency range for which the FLASH memory can be read.
- If the page erase time is longer than  $t_{\text{Erase}}$  (Min), there is no erase-disturb, but it reduces the endurance of the FLASH memory.
- If the mass erase time is longer than  $t_{\text{MErase}}$  (Min), there is no erase-disturb, but it reduces the endurance of the FLASH memory.
- $t_{\text{rcv}}$  is defined as the time it needs before the FLASH can be read after turning off the high voltage charge pump, by clearing HVEN to logic 0.
- $t_{\text{HV}}$  is defined as the cumulative high voltage programming time to the same row before next erase.  
 $t_{\text{HV}}$  must satisfy this condition:  $t_{\text{nvs}} + t_{\text{nvh}} + t_{\text{pgs}} + (t_{\text{PROG}} \times 64) \leq t_{\text{HV}} \text{ max.}$
- $t_{\text{HV1}}$  is the  $t_{\text{HV}}$  spec for 13K-bytes array
- The minimum row endurance value specifies each row of the FLASH memory is guaranteed to work for at least this many erase / program cycles.
- The minimum row endurance value specifies each row of the FLASH memory is guaranteed to work for at least this many erase / program cycles.
- The FLASH is guaranteed to retain data over the entire operating temperature range for at least the minimum time specified.



## Section 25. Mechanical Specifications

### 25.1 Contents

25.2	Introduction . . . . .	357
25.3	64-Pin Plastic Quad Flat Pack (QFP) . . . . .	358

### 25.2 Introduction

This section gives the dimensions for:

- 64-pin plastic quad flat pack (case #840B)

## 25.3 64-Pin Plastic Quad Flat Pack (QFP)

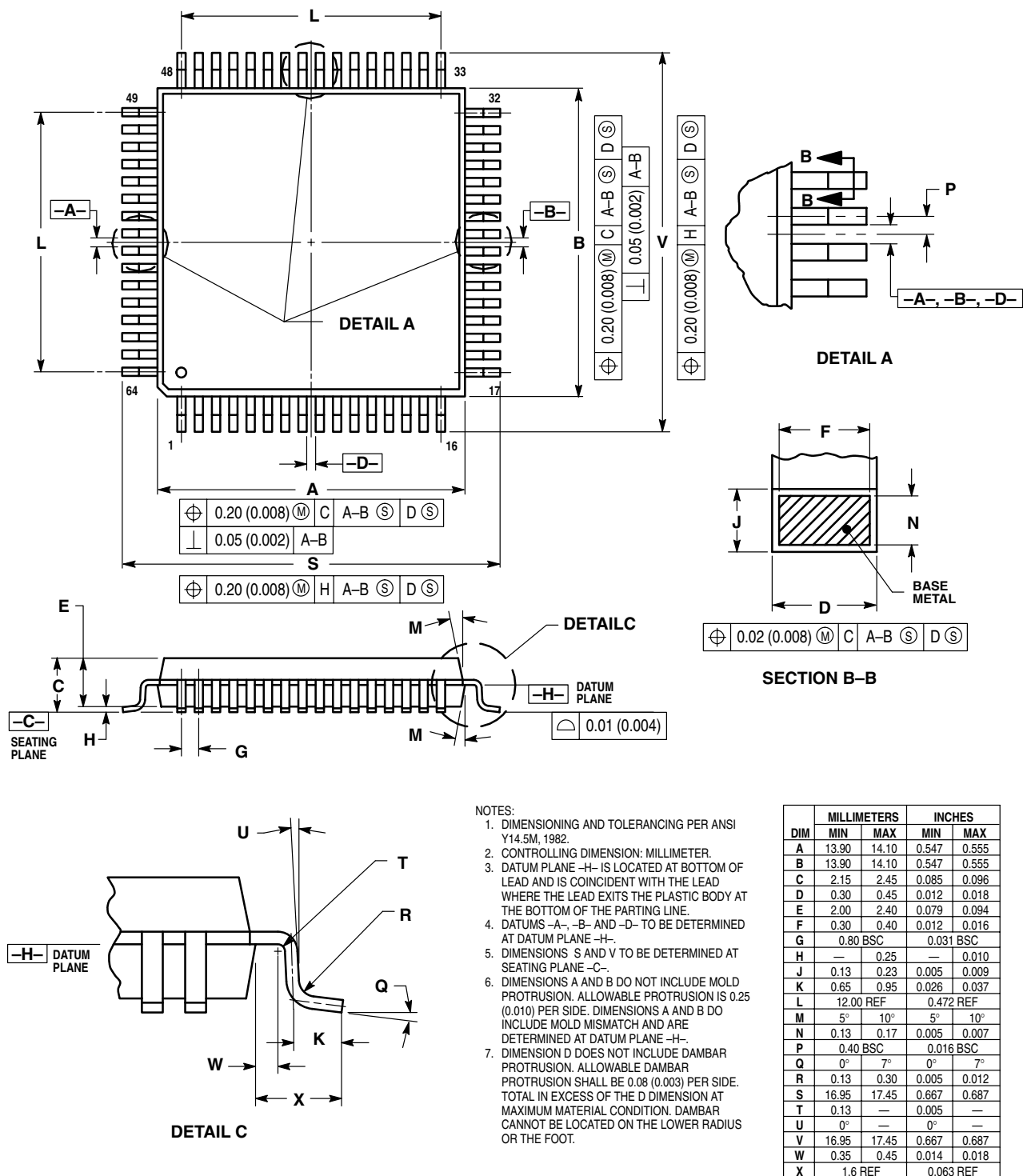

Figure 25-1. 64-Pin QFP (Case #840B)

## Section 26. Ordering Information

### 26.1 Contents

26.2	Introduction . . . . .	359
26.3	MC Order Numbers . . . . .	359

### 26.2 Introduction

This section contains ordering numbers for the MC68HC908LD64.

### 26.3 MC Order Numbers

**Table 26-1. MC Order Numbers**

MC Order Number <sup>(1)</sup>	Package	Operating Temperature Range
MC68HC908LD64IFU	64-Pin QFP	0 °C to +85 °C

**Notes:**

- 1. I = Operating temperature range: 0 °C to +85 °C  
FU = Quad Flat Pack

# Ordering Information





**How to Reach Us:**

**USA/Europe/Locations Not Listed:**

Freescale Semiconductor Literature Distribution Center  
P.O. Box 5405  
Denver, Colorado 80217  
1-800-521-6274 or 480-768-2130

**Japan:**

Freescale Semiconductor Japan Ltd.  
Technical Information Center  
3-20-1, Minami-Azabu, Minato-ku  
Tokyo 106-8573, Japan  
81-3-3440-3569

**Asia/Pacific:**

Freescale Semiconductor Hong Kong Ltd.  
2 Dai King Street  
Tai Po Industrial Estate  
Tai Po, N.T., Hong Kong  
852-26668334

**Home Page:**

[www.freescale.com](http://www.freescale.com)



Information in this document is provided solely to enable system and software implementers to use Freescale Semiconductor products. There are no express or implied copyright licenses granted hereunder to design or fabricate any integrated circuits or integrated circuits based on the information in this document.

Freescale Semiconductor reserves the right to make changes without further notice to any products herein. Freescale Semiconductor makes no warranty, representation or guarantee regarding the suitability of its products for any particular purpose, nor does Freescale Semiconductor assume any liability arising out of the application or use of any product or circuit, and specifically disclaims any and all liability, including without limitation consequential or incidental damages. "Typical" parameters that may be provided in Freescale Semiconductor data sheets and/or specifications can and do vary in different applications and actual performance may vary over time. All operating parameters, including "Typicals", must be validated for each customer application by customer's technical experts. Freescale Semiconductor does not convey any license under its patent rights nor the rights of others. Freescale Semiconductor products are not designed, intended, or authorized for use as components in systems intended for surgical implant into the body, or other applications intended to support or sustain life, or for any other application in which the failure of the Freescale Semiconductor product could create a situation where personal injury or death may occur. Should Buyer purchase or use Freescale Semiconductor products for any such unintended or unauthorized application, Buyer shall indemnify and hold Freescale Semiconductor and its officers, employees, subsidiaries, affiliates, and distributors harmless against all claims, costs, damages, and expenses, and reasonable attorney fees arising out of, directly or indirectly, any claim of personal injury or death associated with such unintended or unauthorized use, even if such claim alleges that Freescale Semiconductor was negligent regarding the design or manufacture of the part.

**Learn More:** For more information about Freescale products, please visit [www.freescale.com](http://www.freescale.com)

Freescale™ and the Freescale logo are trademarks of Freescale Semiconductor, Inc. All other product or service names are the property of their respective owners.

© Freescale Semiconductor, Inc. 2004

MC68HC908LD64  
Rev. 3  
07/2004