

10/100 LAN Interface Module with Enhanced Common Mode Attenuation

EPF8200F2

- Guaranteed to operate with 8 mA DC bias at 70°C •
- Complies with or exceeds IEEE 802.3, 10 BT/100 BX Standards •

Electrical Parameters @ 25° C

OCL @ 70°C	Insertion Loss (dB Max.)				Return Loss (dB Min.)						Common Mode Rejection (dB Min.)						Crosstalk (dB Min.)
	1-80 MHz		150 MHz		1-30 MHz		60 MHz		80 MHz		1-30 MHz		30-100 MHz		100-500 MHz		
Cable Side	Xmit	Rcv	Xmit	Rcv	Xmit	Rcv	Xmit	Rcv	Xmit	Rcv	Xmit	Rcv	Xmit	Rcv	Xmit	Rcv	
350μH	-1	-1	-3	-3	-18	-18	-12	-12	-10	-10	-40	-40	-30	-30	-10	-10	-35

• Isolation : 1500 Vrms • Impedance : 100 Ω • Rise Time : 3.0 nS Max. •

Schematic

Transmit Channel

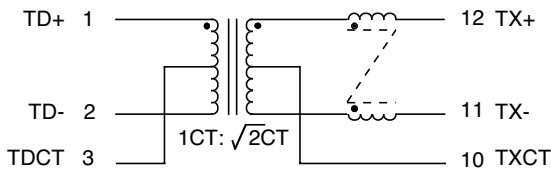

Receive Channel

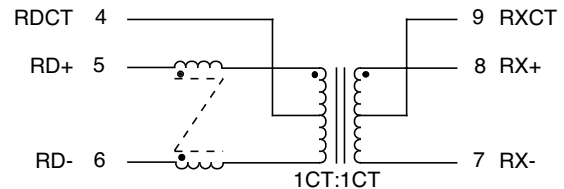

Package

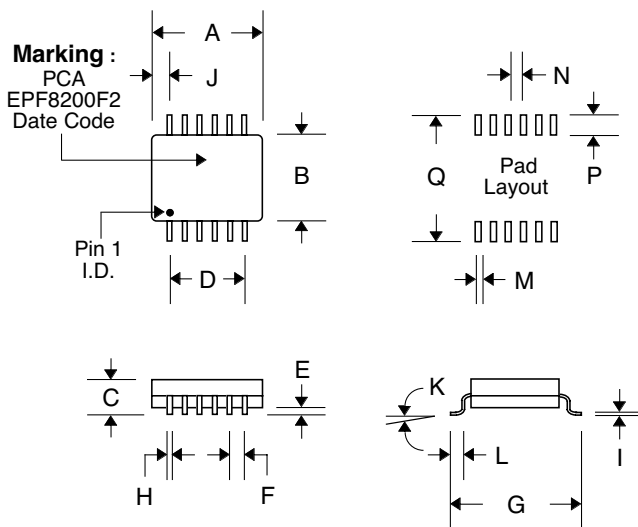

Dimensions

Dim.	(Inches)			(Millimeters)		
	Min.	Max.	Nom.	Min.	Max.	Nom.
A	.570	.590	.580	14.48	14.99	14.73
B	.450	.470	.460	11.43	11.94	11.68
C	.180	.200	.190	4.57	5.08	4.83
D	---	---	.395	---	---	10.03
E	.010	.015	.013	.254	.381	.330
F	---	---	.079	---	---	2.01
G	.570	.590	.580	14.48	14.99	14.73
H	.016	.022	.020	.406	.559	.508
I	.008	.013	.011	.203	.330	.279
J	---	---	.092	---	---	2.34
K	0°	8°	4°	0°	8°	4°
L	.025	.045	.035	.635	1.14	.889
M	---	---	.040	---	---	1.02
N	---	---	.079	---	---	2.01
P	---	---	.092	---	---	2.34
Q	.600	.620	.610	15.24	15.75	15.49