

# DAC121S101QML

## 12-Bit Micro Power Digital-to-Analog Converter with Rail-to-Rail Output

### General Description

The DAC121S101 is a full-featured, general purpose 12-bit voltage-output digital-to-analog converter (DAC) that can operate from a single +2.7 V to 5.5 V supply and consumes just 177  $\mu$ A of current at 3.6 V. The on-chip output amplifier allows rail-to-rail output swing and the three wire serial interface operates at clock rates up to 20 MHz over the specified supply voltage range and is compatible with standard SPI™, QSPI, MICROWIRE and DSP interfaces.

The supply voltage for the DAC121S101 serves as its voltage reference, providing the widest possible output dynamic range. A power-on reset circuit ensures that the DAC output powers up to zero volts and remains there until there is a valid write to the device. A power-down feature reduces power consumption to less than a microWatt.

The low power consumption and small packages of the DAC121S101 make it an excellent choice for use in battery operated equipment.

The DAC121S101 operates over the extended temperature range of -55°C to +125°C.

### Features

- Total Ionizing Dose 100 krad(Si)
- Single Event Latch-up 120 MeV-cm<sup>2</sup>/mg
- Guaranteed Monotonicity
- Low Power Operation
- Rail-to-Rail Voltage Output
- Power-on Reset to Zero Volts Output
- SYNC Interrupt Facility
- Wide power supply range (+2.7 V to +5.5 V)
- Small Packages
- Power Down Feature

### Key Specifications

- Resolution 12 bits
- DNL +0.21, -0.10 LSB (typ)
- Output Settling Time 12.5  $\mu$ s (typ)
- Zero Code Error 2.1 mV (typ)
- Full-Scale Error -0.04 %FS (typ)
- Power Dissipation
  - Normal Mode 0.52 mW (3.6 V) / 1.19 mW (5.5 V) typ
  - Pwr Down 0.014  $\mu$ W (3.6 V) / 0.033  $\mu$ W (5.5 V) typ Mode

### Applications

- Battery-Powered Instruments
- Digital Gain and Offset Adjustment
- Programmable Voltage & Current Sources
- Programmable Attenuators

### Ordering Information

NS Part Number	SMD Part Number	NS Package Number	Package Description
DAC121S101WGRQV <b>Flight Part</b>	5962R0722601VZA 100 krad(Si)	WG10A	10LD Ceramic SOIC
DAC121S101WGMPR <b>Pre-flight Prototype</b>		WG10A	10LD Ceramic SOIC
DAC121S101CVAL <b>Ceramic Evaluation Board</b>			10LD Ceramic SOIC on Evaluation Board

SPI™ is a trademark of Motorola, Inc.

## Connection Diagrams

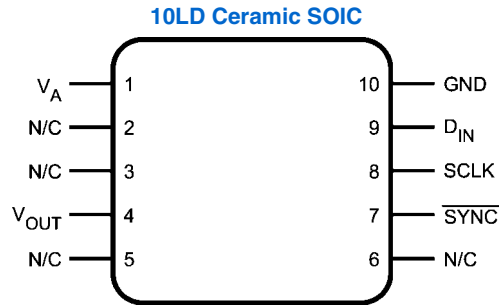

30018001

**Top View**  
See NS Package Number WG10A

## Block Diagram

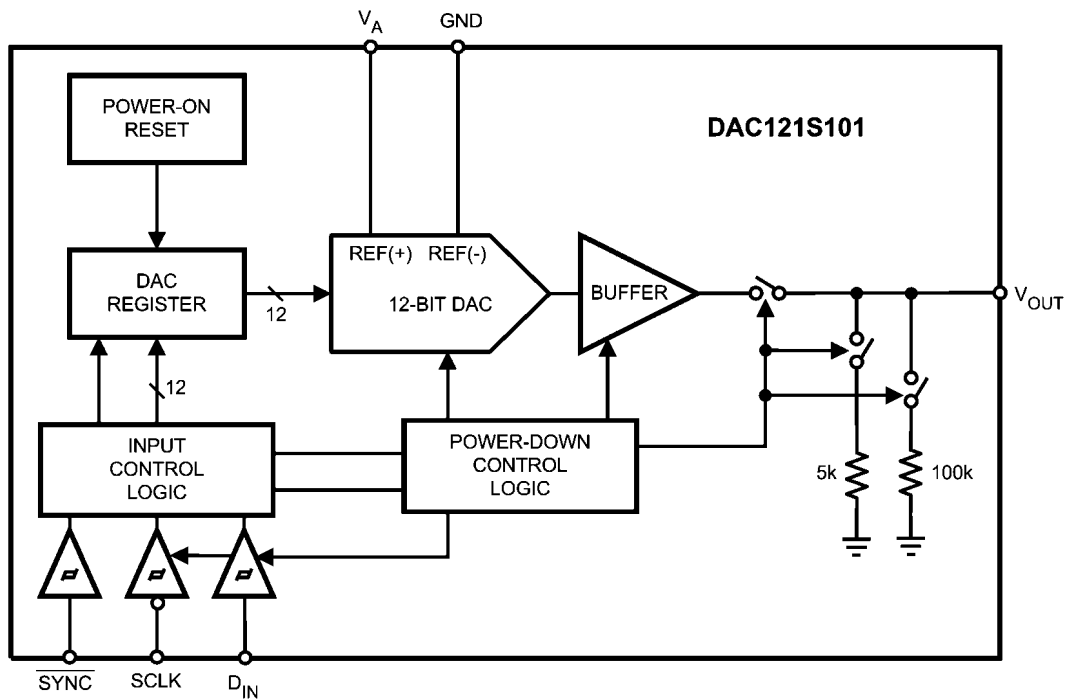

30018003

## Absolute Maximum Ratings

(Note 1, Note 2)

Supply Voltage, $V_A$	6.5 V
Voltage on any Input Pin	-0.3 V to ( $V_A + 0.3$ V)
Input Current at Any Pin (Note 3)	10 mA
Maximum Output Current (Note 10)	10 mA
$V_{OUT}$ Pin in Powerdown Mode	1.0 mA
Package Input Current (Note 3)	20 mA
Power Dissipation at $T_A = 25^\circ\text{C}$	See (Note 4)
Maximum Junction Temperature	175°C
Lead Temperature	
Ceramic SOIC (Soldering 10 Seconds)	260°C
Storage Temperature	-65°C to +150°C
Package Weight (Typical)	
Ceramic SOIC	220 mg
ESD Tolerance (Note 5)	Class 3A (5000 V)

## Operating Ratings (Note 1, Note 2)

Operating Temperature Range	-55°C to +125°C
Supply Voltage, $V_A$	+2.7 V to 5.5 V
Any Input Voltage (Note 6)	-0.1 V to ( $V_A + 0.1$ V)
Output Load	0 to 1500 pF
SCLK Frequency	Up to 20 MHz

## Package Thermal Resistance

Package	$\theta_{JA}$ (Still Air)	$\theta_{JC}$
10-lead Ceramic SOIC Package on 2 layer, 1oz. PCB	214°C/W	25.7°C/W

## Quality Conformance Inspection

MIL-STD-883, Method 5005 - Group A

Subgroup	Description	Temp (° C)
1	Static tests at	+25
2	Static tests at	+125
3	Static tests at	-55
4	Dynamic tests at	+25
5	Dynamic tests at	+125
6	Dynamic tests at	-55
7	Functional tests at	+25
8A	Functional tests at	+125
8B	Functional tests at	-55
9	Switching tests at	+25
10	Switching tests at	+125
11	Switching tests at	-55
12	Setting time at	+25
13	Setting time at	+125
14	Setting time at	-55

## DAC121S101 Electrical Characteristics

### DC Parameters

The following specifications apply for  $V_A = +2.7\text{ V to }+5.5\text{ V}$ ,  $R_L = \infty$ ,  $C_L = 200\text{ pF to GND}$ ,  $f_{\text{SCLK}} = 20\text{ MHz}$ , input code range 48 to 4047. **Boldface limits apply for  $T_{\text{MIN}} \leq T_A \leq T_{\text{MAX}}$** ; all other limits  $T_A = 25^\circ\text{C}$ , unless otherwise specified.

Symbol	Parameter	Conditions	Notes	Typical (Note 8)	Min	Max	Units	Sub-groups
<b>STATIC PERFORMANCE</b>								
	Resolution		(Note 9)		<b>12</b>		Bits	
	Monotonicity		(Note 9)		<b>12</b>		Bits	
INL	Integral Non-Linearity	Over Decimal codes 48 to 4047		$\pm 2.75$	<b>-8.0</b>	<b>8.0</b>	LSB	1, 2, 3
DNL	Differential Non-Linearity	$V_A = 2.7\text{ V to }5.5\text{ V}$		+0.21		<b>+1.0</b>	LSB	1, 2, 3
				-0.10		<b>-0.7</b>	LSB	1, 2, 3
ZE	Zero Code Error	$I_{\text{OUT}} = 0$		+2.12		<b>+15</b>	mV	1, 2, 3
FSE	Full-Scale Error	$I_{\text{OUT}} = 0$		-0.04		<b>-1.0</b>	%FSR	1, 2, 3
GE	Gain Error	All ones Loaded to DAC register		-0.11		<b><math>\pm 1.0</math></b>	%FSR	1, 2, 3
ZCED	Zero Code Error Drift		(Note 9)	-20			$\mu\text{V}/^\circ\text{C}$	
TC GE	Gain Error Tempco	$V_A = 3\text{ V}$	(Note 9)	-0.7			ppm/ $^\circ\text{C}$	
		$V_A = 5\text{ V}$		-1.0			ppm/ $^\circ\text{C}$	
<b>OUTPUT CHARACTERISTICS</b>								
IPD SINK	Vout Pin in Powerdown Mode	All PD Modes	(Note 9)			<b>1.0</b>	mA	
	Output Voltage Range		(Note 9)		<b>0</b>	$V_A$	V	
ZCO	Zero Code Output	$V_A = 3\text{ V}, I_{\text{OUT}} = 10\text{ }\mu\text{A}$		2.0		<b>6</b>	mV	1, 2, 3
		$V_A = 3\text{ V}, I_{\text{OUT}} = 100\text{ }\mu\text{A}$		4		<b>10</b>	mV	1, 2, 3
		$V_A = 5\text{ V}, I_{\text{OUT}} = 10\text{ }\mu\text{A}$		2		<b>8</b>	mV	1, 2, 3
		$V_A = 5\text{ V}, I_{\text{OUT}} = 100\text{ }\mu\text{A}$		4		<b>9</b>	mV	1, 2, 3
FSO	Full Scale Output	$V_A = 3\text{ V}, I_{\text{OUT}} = 10\text{ }\mu\text{A}$		2.997	<b>2.990</b>		V	1, 2, 3
		$V_A = 3\text{ V}, I_{\text{OUT}} = 100\text{ }\mu\text{A}$		2.991	<b>2.985</b>		V	1, 2, 3
		$V_A = 5\text{ V}, I_{\text{OUT}} = 10\text{ }\mu\text{A}$		4.994	<b>4.985</b>		V	1, 2, 3
		$V_A = 5\text{ V}, I_{\text{OUT}} = 100\text{ }\mu\text{A}$		4.992	<b>4.985</b>		V	1, 2, 3
	Maximum Load Capacitance	$R_L = \infty$	(Note 9)	1500			pF	
		$R_L = 2\text{ k}\Omega$		1500			pF	
	DC Output Impedance			8		16	$\Omega$	1, 2, 3

## DC Parameters (Continued)

The following specifications apply for  $V_A = +2.7\text{ V to }+5.5\text{ V}$ ,  $R_L = \infty$ ,  $C_L = 200\text{ pF to GND}$ ,  $f_{SCLK} = 20\text{ MHz}$ , input code range 48 to 4047. **Boldface limits apply for  $T_{MIN} \leq T_A \leq T_{MAX}$** ; all other limits  $T_A = 25^\circ\text{C}$ , unless otherwise specified.

Symbol	Parameter	Conditions	Notes	Typical (Note 8)	Min	Max	Units	Sub-groups	
<b>LOGIC INPUT</b>									
$I_{IN}$	Input Current			6	-200	+200	nA	1, 2, 3	
$V_{IL}$	Input Low Voltage	$V_A = 5\text{ V}$				<b>0.8</b>	V	1, 2, 3	
		$V_A = 3\text{ V}$				<b>0.5</b>	V	1, 2, 3	
$V_{IH}$	Input High Voltage	$V_A = 5\text{ V}$			<b>2.4</b>		V	1, 2, 3	
		$V_A = 3\text{ V}$			<b>2.1</b>		V	1, 2, 3	
$C_{IN}$	Input Capacitance		(Note 9)	5			pF		
<b>POWER REQUIREMENTS</b>									
$I_A$	Supply Current (output unloaded)	Normal Mode	5.5 V		216		<b>270</b>	$\mu\text{A}$	1, 2, 3
		$f_{SCLK} = 20\text{ MHz}$	3.6 V		145		<b>200</b>	$\mu\text{A}$	1, 2, 3
		Normal Mode	5.5 V		185		<b>230</b>	$\mu\text{A}$	1, 2, 3
		$f_{SCLK} = 10\text{ MHz}$	3.6 V		132		<b>175</b>	$\mu\text{A}$	1, 2, 3
		Normal Mode	5.5 V		150		<b>190</b>	$\mu\text{A}$	1, 2, 3
		$f_{SCLK} = 0$	3.6 V		115		<b>160</b>	$\mu\text{A}$	1, 2, 3
		All PD Modes, $f_{SCLK} = 20\text{ MHz}$	5.5 V		22		<b>60</b>	$\mu\text{A}$	1, 2, 3
			3.6 V		12		<b>30</b>	$\mu\text{A}$	1, 2, 3
		All PD Modes, $f_{SCLK} = 10\text{ MHz}$	5.5 V		12		<b>40</b>	$\mu\text{A}$	1, 2, 3
			3.6 V		6		<b>20</b>	$\mu\text{A}$	1, 2, 3
		All PD Modes, $f_{SCLK} = 0$	5.5 V		.006		<b>1.0</b>	$\mu\text{A}$	1, 2, 3
			3.6 V		.004		<b>1.0</b>	$\mu\text{A}$	1, 2, 3
$P_C$	Power Consumption (output unloaded)	Normal Mode	5.5 V	(Note 9)	1.19		<b>1.49</b>	mW	
		$f_{SCLK} = 20\text{ MHz}$	3.6 V		0.52		<b>.72</b>	mW	
		Normal Mode	5.5 V	(Note 9)	1.02		<b>1.27</b>	mW	
		$f_{SCLK} = 10\text{ MHz}$	3.6 V		0.47		<b>.63</b>	mW	
		Normal Mode	5.5 V	(Note 9)	0.82		<b>1.05</b>	mW	
		$f_{SCLK} = 0$	3.6 V		0.41		<b>.58</b>	mW	
		All PD Modes, $f_{SCLK} = 20\text{ MHz}$	5.5 V	(Note 9)	0.12		<b>.33</b>	mW	
			3.6 V		0.07		<b>.11</b>	mW	
All PD Modes, $f_{SCLK} = 10\text{ MHz}$	5.5 V	(Note 9)	0.04		<b>.22</b>	mW			
	3.6 V		0.02		<b>.08</b>	mW			
		All PD Modes, $f_{SCLK} = 0$	5.5 V	(Note 9)	0.033		<b>5.5</b>	$\mu\text{W}$	
			3.6 V		0.014		<b>3.6</b>	$\mu\text{W}$	
$I_{OUT} / I_A$	Power Efficiency	$I_{LOAD} = 2\text{ mA}$	(Note 9)	91			%		
				94			%		

## AC and Timing Characteristics

The following specifications apply for  $V_A = +2.7\text{ V to }+5.5\text{ V}$ ,  $R_L = \infty$ ,  $C_L = 200\text{ pF to GND}$ ,  $f_{\text{SCLK}} = 20\text{ MHz}$ , input code range 48 to 4047. **Boldface limits apply for  $T_{\text{MIN}} \leq T_A \leq T_{\text{MAX}}$** : all other limits  $T_A = 25^\circ\text{C}$ , unless otherwise specified.

Symbol	Parameter	Conductions	Notes	Typical (Note 8)	Min	Max	Units	Sub-groups
$f_{\text{SCLK}}$	SCLK Frequency	(See <a href="#">Figure 2</a> )	(Note 9)			<b>20</b>	MHz	9, 10, 11
$t_s$	Output Voltage Settling Time	FF0 to 00F code change, $R_L = \infty$		$C_L \leq 200\text{ pF}$		<b>15</b>	$\mu\text{s}$	9, 10, 11
				$C_L = 500\text{ pF}$		<b>15</b>	$\mu\text{s}$	9, 10, 11
		00Fh to FF0h code change, $R_L = \infty$		$C_L \leq 200\text{ pF}$		<b>15</b>	$\mu\text{s}$	9, 10, 11
				$C_L = 500\text{ pF}$		<b>15</b>	$\mu\text{s}$	9, 10, 11
SR	Output Slew Rate		(Note 9)	1		$\text{V}/\mu\text{s}$		
	Glitch Impulse	Code change from 800h to 7FFh	(Note 9)	12			nV-sec	
	Digital Feedthrough		(Note 9)	0.5			nV-sec	
$t_{\text{WU}}$	Wake-Up Time	$V_A = 5\text{ V}$	(Note 9)	.65			$\mu\text{s}$	
		$V_A = 3\text{ V}$		1.1			$\mu\text{s}$	
$1/f_{\text{SCLK}}$	SCLK Cycle Time	(See <a href="#">Figure 2</a> )			<b>50</b>		ns	9, 10, 11
$t_H$	SCLK High time	(See <a href="#">Figure 2</a> )			<b>20</b>		ns	9, 10, 11
$t_L$	SCLK Low Time	(See <a href="#">Figure 2</a> )			<b>20</b>		ns	9, 10, 11
$t_{\text{SUCL}}$	Set-up Time $\overline{\text{SYNC}}$ to SCLK Rising Edge	(See <a href="#">Figure 2</a> )			<b>0</b>		ns	9, 10, 11
$t_{\text{SUD}}$	Data Set-Up Time	(See <a href="#">Figure 2</a> )			<b>6</b>		ns	9, 10, 11
$t_{\text{DHD}}$	Data Hold Time	(See <a href="#">Figure 2</a> )			<b>4.5</b>		ns	9, 10, 11
$t_{\text{CS}}$	SCLK fall to rise of $\overline{\text{SYNC}}$	$V_A = 5.5\text{ V}$ (See <a href="#">Figure 2</a> )			<b>10</b>		ns	9, 10, 11
		$V_A = 2.7\text{ V}$ (See <a href="#">Figure 2</a> )			<b>18</b>		ns	9, 10, 11
$t_{\text{SYNC}}$	$\overline{\text{SYNC}}$ High Time	$V_A = 5.5\text{ V}$ (See <a href="#">Figure 2</a> )			<b>37</b>		ns	9, 10, 11
		$V_A = 2.7\text{ V}$ (See <a href="#">Figure 2</a> )			<b>36</b>		ns	9, 10, 11

## Radiation Electrical Characteristics (Note 12)

The following specifications apply for  $V_A = +2.7\text{ V}$  to  $+5.5\text{ V}$ ,  $R_L = \infty$ ,  $C_L = 200\text{ pF}$  to GND,  $f_{\text{SCLK}} = 20\text{ MHz}$ , input code range 48 to 4047.

Symbol	Parameter	Conditions	Min	Max	Units	Sub-groups
<b>POWER REQUIREMENTS</b>						
$I_A$	Supply Current (output unloaded)	Normal Mode $f_{\text{SCLK}} = 20\text{ MHz}$	5.5 V	325	$\mu\text{A}$	1
			3.6 V	250	$\mu\text{A}$	1
		Normal Mode $f_{\text{SCLK}} = 10\text{ MHz}$	5.5 V	300	$\mu\text{A}$	1
			3.6 V	225	$\mu\text{A}$	1
		Normal Mode $f_{\text{SCLK}} = 0$	5.5 V	275	$\mu\text{A}$	1
			3.6 V	200	$\mu\text{A}$	1
		All PD Modes, $f_{\text{SCLK}} = 20\text{ MHz}$	5.5 V	125	$\mu\text{A}$	1
			3.6 V	100	$\mu\text{A}$	1
		All PD Modes, $f_{\text{SCLK}} = 10\text{ MHz}$	5.5 V	115	$\mu\text{A}$	1
			3.6 V	95	$\mu\text{A}$	1
All PD Modes, $f_{\text{SCLK}} = 0$	5.5 V	100	$\mu\text{A}$	1		
	3.6 V	100	$\mu\text{A}$	1		

## Operating Life Test Delta Parameters $T_A @ 25^\circ\text{C}$ (Note 11)

Symbol	Parameter	Conditions	Min	Max	Units
INL	Integral non-linearity			$\pm 2$	LBS
ts	Output voltage settling time			$\pm 5$	$\mu\text{A}$
$I_A$	Supply Current (output unloaded)	Normal Mode, $V_A = 5.5\text{ V}$ $f_{\text{SCLK}} = 20\text{ MHz}$		$\pm 10$	$\mu\text{A}$
		Normal Mode, $V_A = 3.6\text{ V}$ $f_{\text{SCLK}} = 20\text{ MHz}$		$\pm 6$	$\mu\text{A}$
		Normal Mode, $V_A = 5.5\text{ V}$ $f_{\text{SCLK}} = 10\text{ MHz}$		$\pm 10$	$\mu\text{A}$
		Normal Mode, $V_A = 3.6\text{ V}$ $f_{\text{SCLK}} = 10\text{ MHz}$		$\pm 6$	$\mu\text{A}$
		Normal Mode, $V_A = 5.5\text{ V}$ $f_{\text{SCLK}} = 0$		$\pm 8$	$\mu\text{A}$
		Normal Mode, $V_A = 3.6\text{ V}$ $f_{\text{SCLK}} = 0$		$\pm 6$	$\mu\text{A}$
		All PD Modes, $V_A = 5.5\text{ V}$ $f_{\text{SCLK}} = 20\text{ MHz}$		$\pm 2$	$\mu\text{A}$
		All PD Modes, $V_A = 3.6\text{ V}$ $f_{\text{SCLK}} = 20\text{ MHz}$		$\pm 1$	$\mu\text{A}$
		All PD Modes, $V_A = 5.5\text{ V}$ $f_{\text{SCLK}} = 10\text{ MHz}$		$\pm 1$	$\mu\text{A}$
		All PD Modes, $V_A = 3.6\text{ V}$ $f_{\text{SCLK}} = 10\text{ MHz}$		$\pm 1$	$\mu\text{A}$
		All PD Modes, $V_A = 5.5\text{ V}$ $f_{\text{SCLK}} = 0$		$\pm 0.1$	$\mu\text{A}$
		All PD Modes, $V_A = 3.6\text{ V}$ $f_{\text{SCLK}} = 0$		$\pm 0.1$	$\mu\text{A}$

**Note 1:** Absolute Maximum Ratings indicate limits beyond which damage to the device may occur. Operating Ratings indicate conditions for which the device is functional, but do not guarantee specific performance limits. For guaranteed specifications and test conditions, see the Electrical Characteristics. The guaranteed specifications apply only for the test conditions listed. Some performance characteristics may degrade when the device is not operated under the listed test conditions.

**Note 2:** All voltages are measured with respect to GND = 0 V, unless otherwise specified

**Note 3:** When the input voltage at any pin exceeds the power supplies (that is, less than GND, or greater than  $V_A$ ), the current at that pin should be limited to 10 mA. The 20 mA maximum package input current rating limits the number of pins that can safely exceed the power supplies with an input current of 10 mA to two.

**Note 4:** The absolute maximum junction temperature ( $T_{Jmax}$ ) for this device is 175°C. The maximum allowable power dissipation is dictated by  $T_{Jmax}$ , the junction-to-ambient thermal resistance ( $\theta_{JA}$ ), and the ambient temperature ( $T_A$ ), and can be calculated using the formula  $P_{DMAX} = (T_{Jmax} - T_A) / \theta_{JA}$ . The values for maximum power dissipation will be reached only when the device is operated in a severe fault condition (e.g., when input or output pins are driven beyond the power supply voltages, or the power supply polarity is reversed). Obviously, such conditions should always be avoided.

**Note 5:** Human body model is 100 pF capacitor discharged through a 1.5 k $\Omega$  resistor. Machine model is 220 pF discharged through ZERO Ohms.

**Note 6:** The analog inputs are protected as shown below. Input voltage magnitudes up to  $V_A + 300$  mV or to 300 mV below GND will not damage this device. However, errors in the conversion result can occur if any input goes above  $V_A$  or below GND by more than 100 mV. For example, if  $V_A$  is 2.7  $V_{DC}$ , ensure that  $-100$  mV  $\leq$  input voltages  $\leq 2.8$   $V_{DC}$  to ensure accurate conversions.

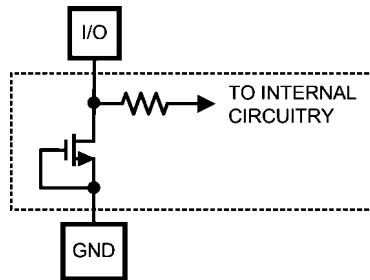

30018004

**Note 7:** To guarantee accuracy, it is required that  $V_A$  be well bypassed.

**Note 8:** Typical figures are at  $T_J = 25^\circ\text{C}$ , and represent most likely parametric norms.

**Note 9:** This parameter is guaranteed by design and/or characterization and is not tested in production.

**Note 10:** Maximum Output Current may not exceed 10 mA. At  $V_{DD} = 5.5$  V the minimum external resistive load can be no less than 550  $\Omega$ , (360  $\Omega$  at  $V_{DD} = 3.6$  V).

**Note 11:** These parameters are worse case drift. Deltas are performed at room temperature Post OP Life. All other parameters no Deltas are required.

**Note 12:** Pre and post irradiation limits are identical to those listed in the "DC Parameters" and "AC and Timing Characteristics" tables, except as listed in the "Radiation Electrical Characteristics" table. When performing post irradiation electrical measurements for any RHA level,  $T_A = +25^\circ\text{C}$ . See section 3.0 for dose rate and test conditions.



## Specification Definitions

**DIFFERENTIAL NON-LINEARITY (DNL)** is the measure of the maximum deviation from the ideal step size of 1 LSB, which is  $V_{REF} / 4096 = V_A / 4096$ .

**DIGITAL FEEDTHROUGH** is a measure of the energy injected into the analog output of the DAC from the digital inputs when the DAC outputs are not updated. It is measured with a full-scale code change on the data bus.

**FULL-SCALE ERROR** is the difference between the actual output voltage with a full scale code (FFFh) loaded into the DAC and the value of  $V_A \times 4095 / 4096$ .

**GAIN ERROR** is the deviation from the ideal slope of the transfer function. It can be calculated from Zero and Full-Scale Errors as  $GE = FSE - ZE$ , where GE is Gain error, FSE is Full-Scale Error and ZE is Zero Error.

**GLITCH IMPULSE** is the energy injected into the analog output when the input code to the DAC register changes. It is specified as the area of the glitch in nanovolt-seconds.

**INTEGRAL NON-LINEARITY (INL)** is a measure of the deviation of each individual code from a straight line through the input to output transfer function. The deviation of any given code from this straight line is measured from the center of that code value. The end point method is used. INL for this product is specified over a limited range, per the Electrical Tables.

**LEAST SIGNIFICANT BIT (LSB)** is the bit that has the smallest value or weight of all bits in a word. This value is

$$LSB = V_{REF} / 2^n$$

where  $V_{REF}$  is the supply voltage for this product, and "n" is the DAC resolution in bits, which is 12 for the DAC121S101.

**MAXIMUM LOAD CAPACITANCE** is the maximum capacitance that can be driven by the DAC with output stability maintained.

**MONOTONICITY** is the condition of being monotonic, where the DAC has an output that never decreases when the input code increases.

**MOST SIGNIFICANT BIT (MSB)** is the bit that has the largest value or weight of all bits in a word. Its value is 1/2 of  $V_A$ .

**POWER EFFICIENCY** is the ratio of the output current to the total supply current. The output current comes from the power supply. The difference between the supply and output currents is the power consumed by the device without a load.

**SETTLING TIME** is the time for the output to settle to within 1/2 LSB of the final value after the input code is updated.

**WAKE-UP TIME** is the time for the output to exit power-down mode. This is the time measured from the falling edge of 16th SCLK pulse to when the output voltage deviates from the power-down voltage of 0 V.

**ZERO CODE ERROR** is the output error, or voltage, present at the DAC output after a code of 000h has been entered.

## Transfer Characteristic

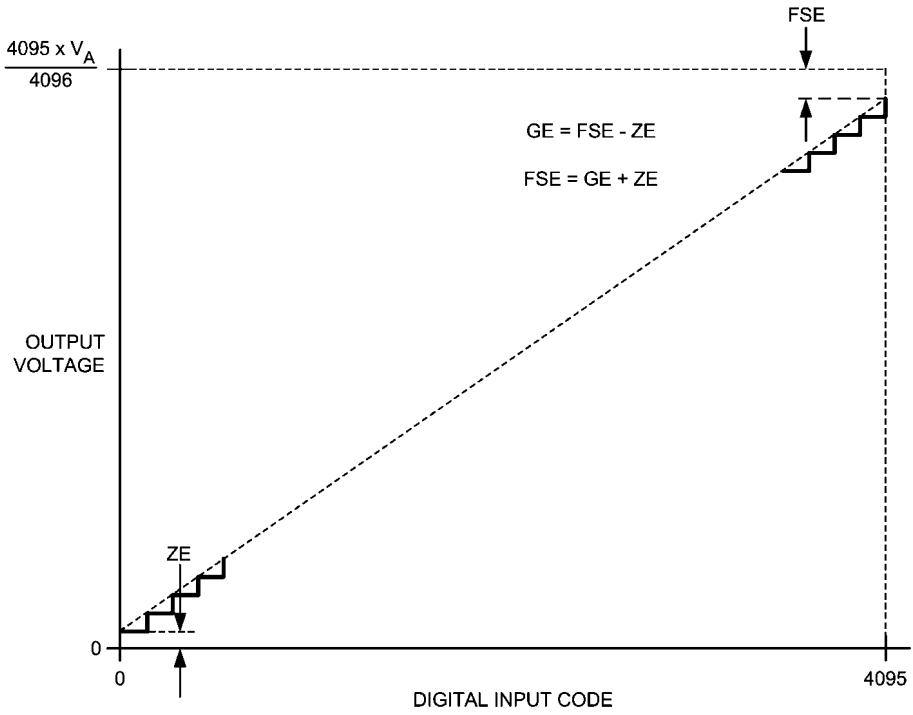

FIGURE 1. Input / Output Transfer Characteristic

## Timing Diagram

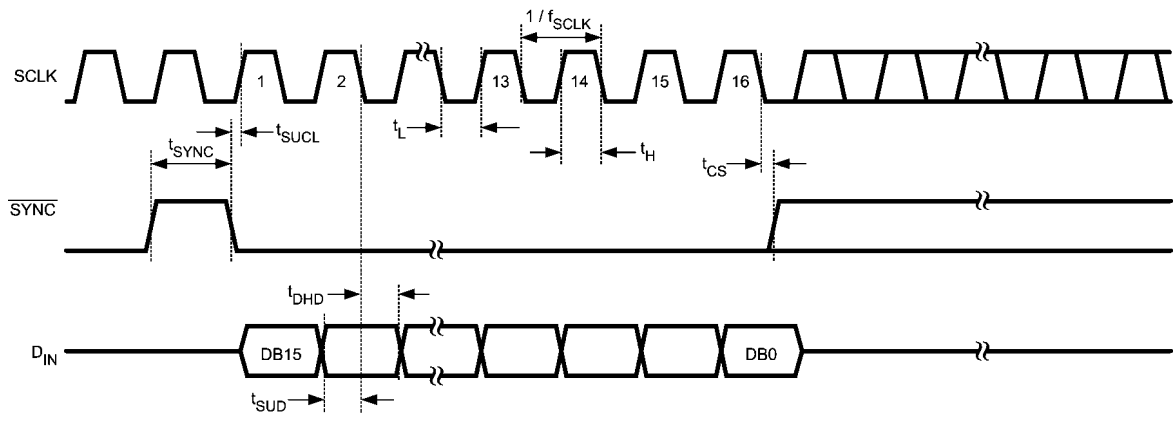
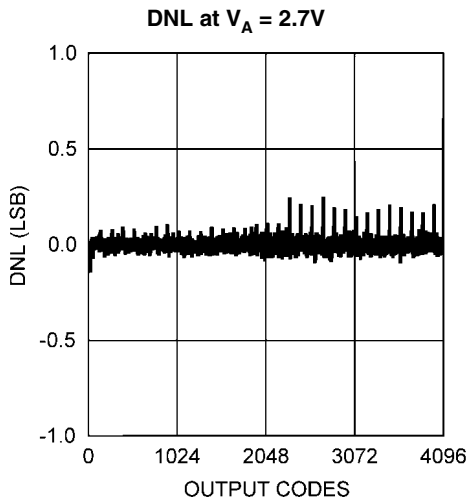

FIGURE 2. DAC121S101 Timing

## Typical Performance Characteristics

otherwise stated

$f_{SCLK} = 20 \text{ MHz}$ ,  $T_A = 25\text{C}$ , Input Code Range 48 to 4047, unless



30018052

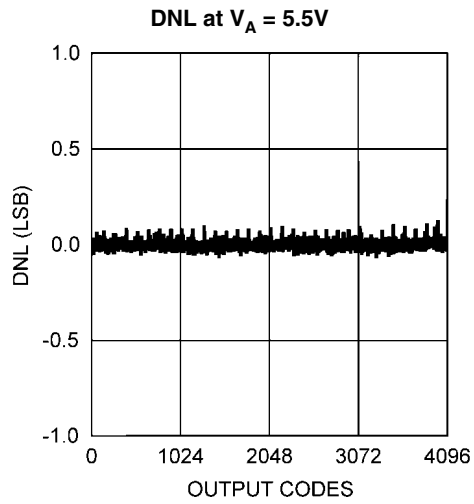

30018053

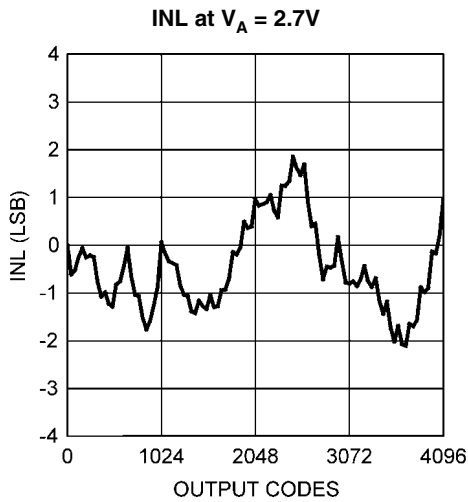

30018054

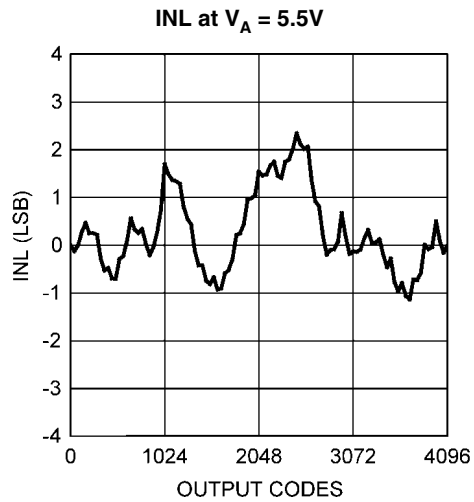

30018055

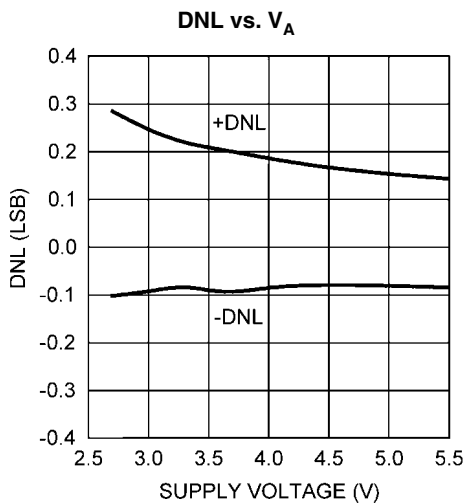

30018022

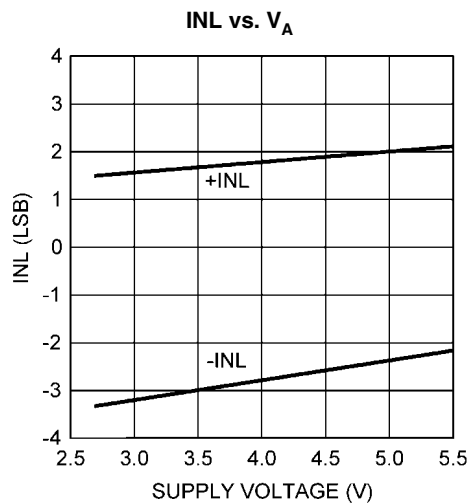

30018023

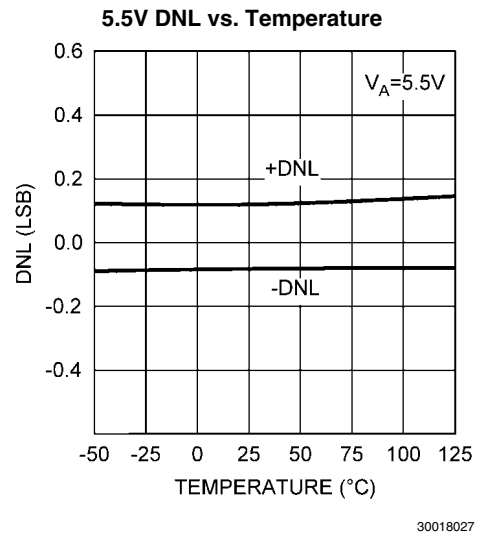
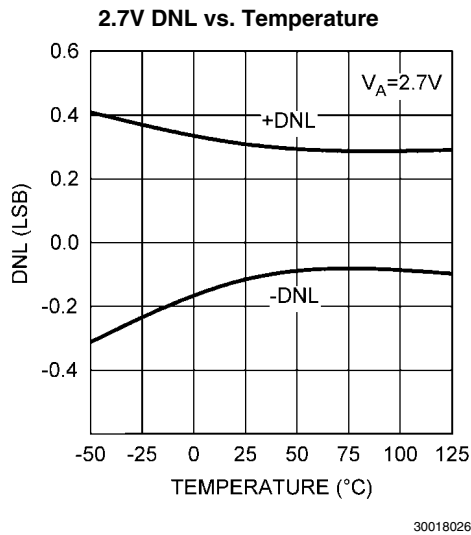
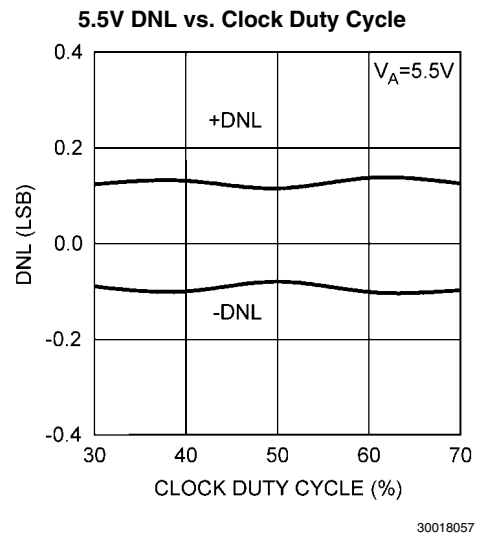
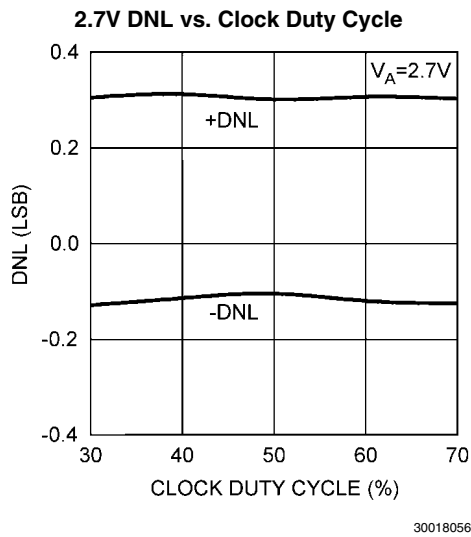
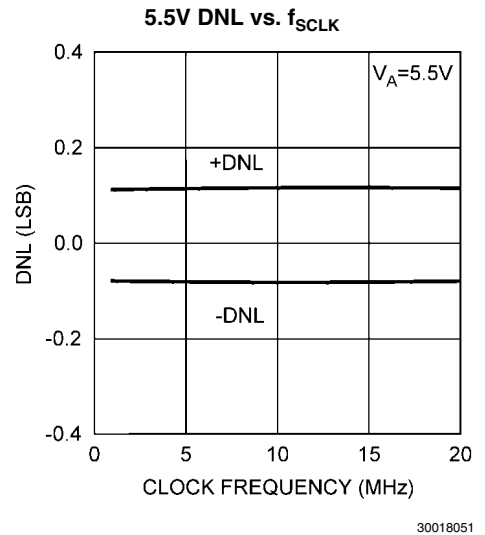
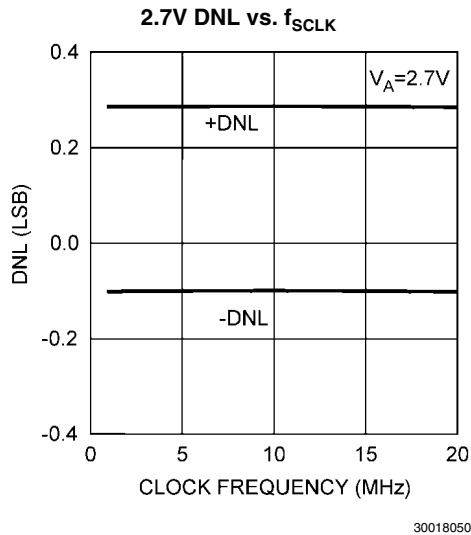

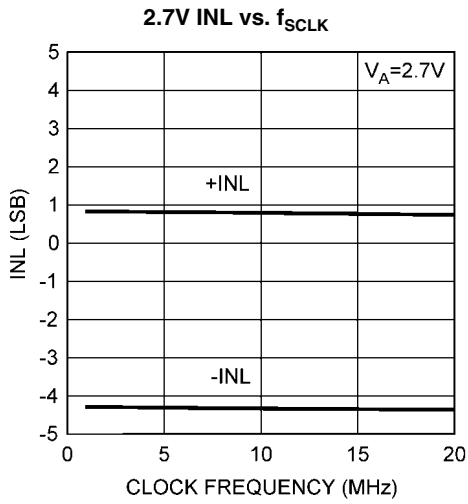

30018028

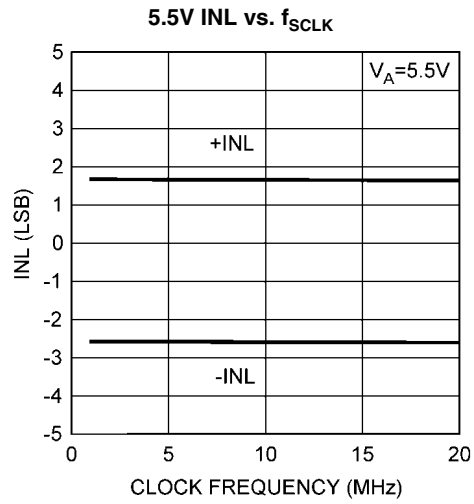

30018029

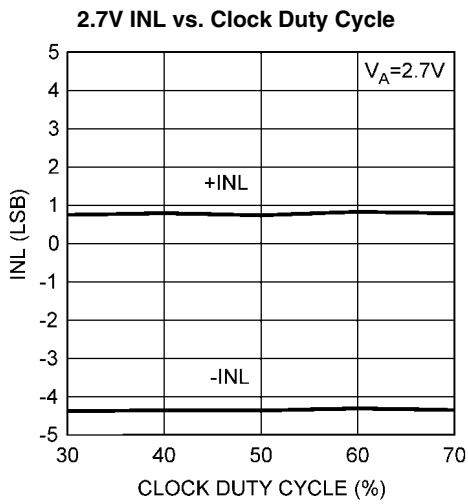

30018030

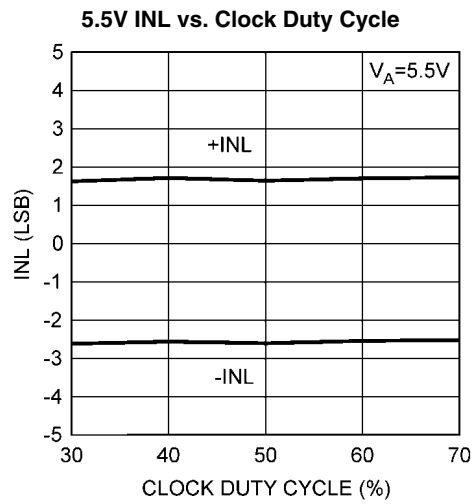

30018031

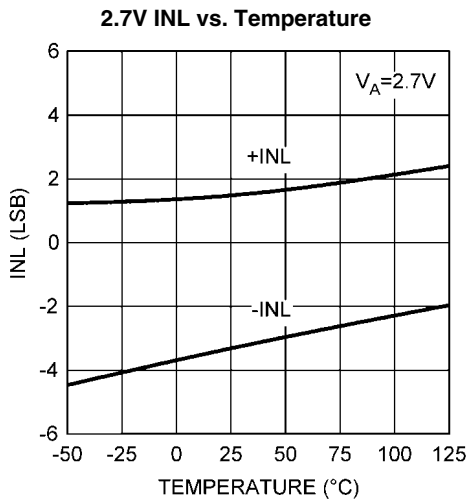

30018032

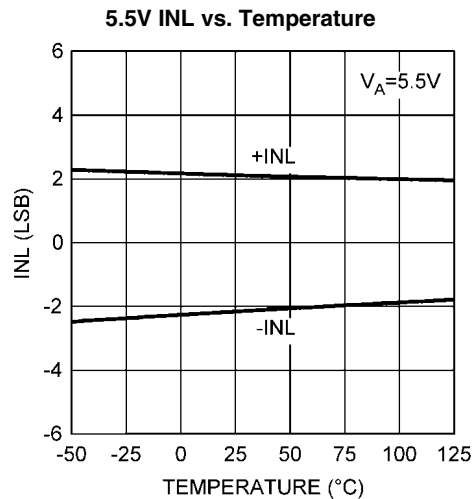

30018033

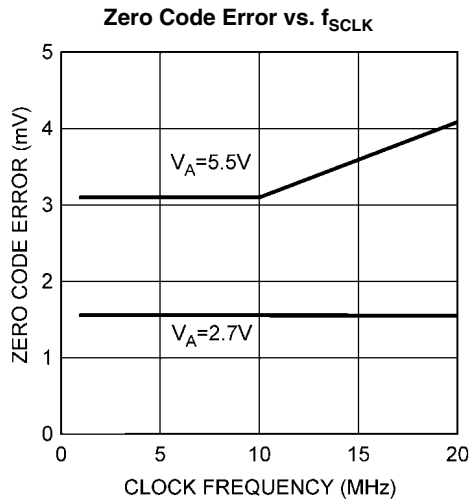

30018034

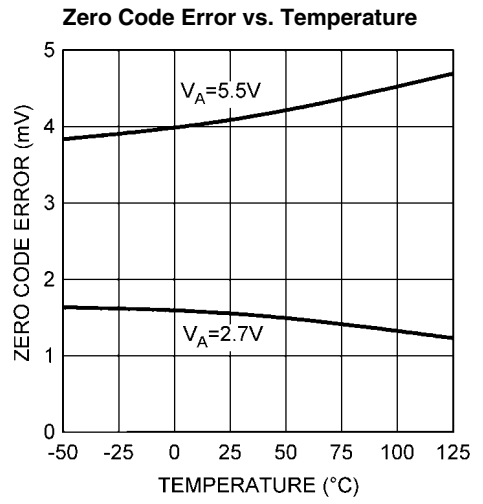

30018036

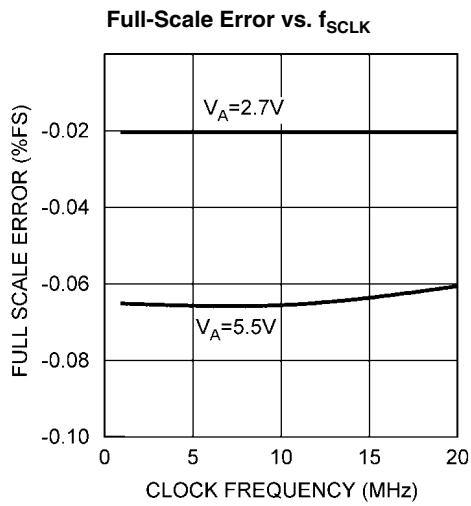

30018037

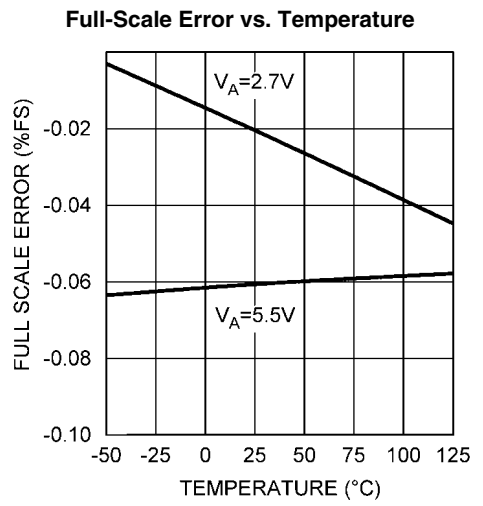

30018039

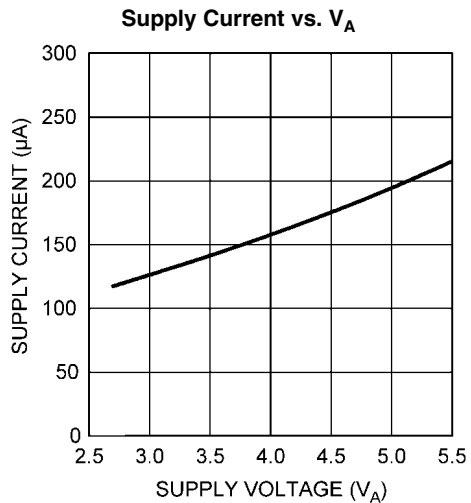

30018044

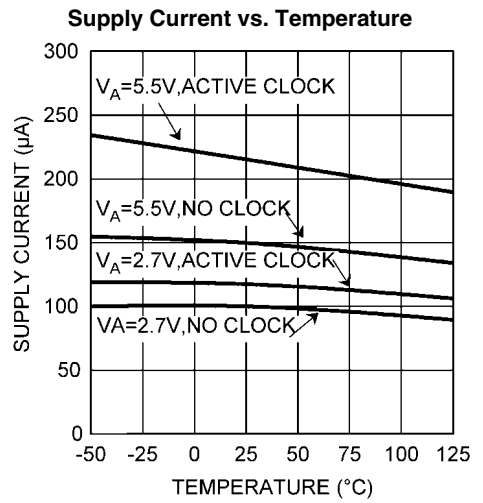

30018045

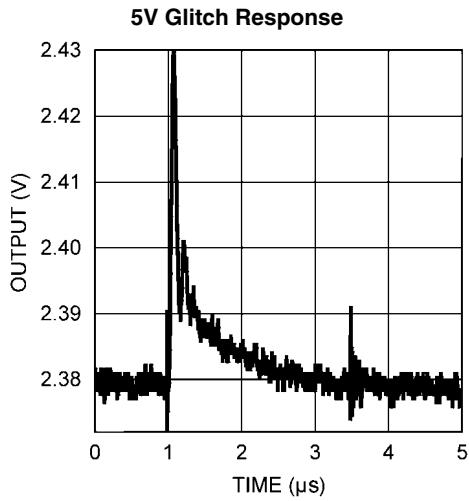

30018046

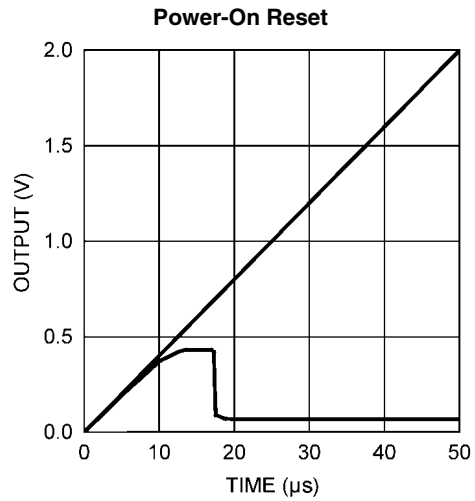

30018047

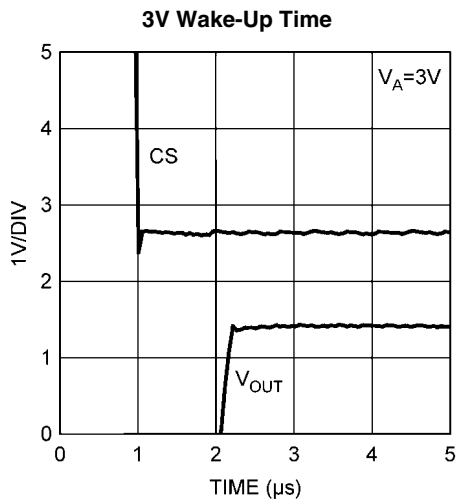

30018048

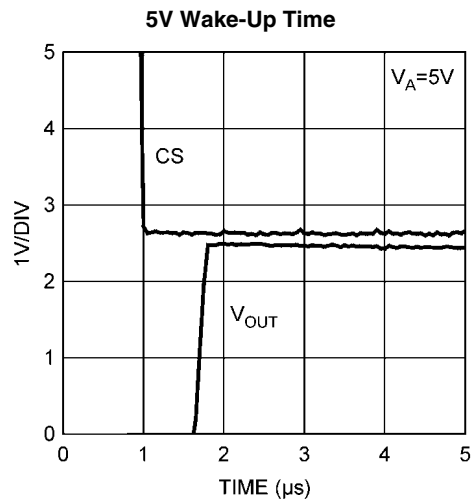

30018049

## 1.0 Functional Description

### 1.1 DAC SECTION

The DAC121S101 is fabricated on a CMOS process with an architecture that consists of switches and a resistor string that are followed by an output buffer. The power supply serves as the reference voltage. The input coding is straight binary with an ideal output voltage of:

$$V_{OUT} = V_A \times (D / 4096)$$

where  $D$  is the decimal equivalent of the binary code that is loaded into the DAC register and can take on any value between 0 and 4095.

### 1.2 RESISTOR STRING

The simplified resistor string is shown in *Figure 3*. Conceptually, this string consists of 4096 equal valued resistors with a switch at each junction of two resistors, plus a switch to ground. The code loaded into the DAC register determines which switch is closed, connecting the proper node to the amplifier. This configuration guarantees that the DAC is monotonic.

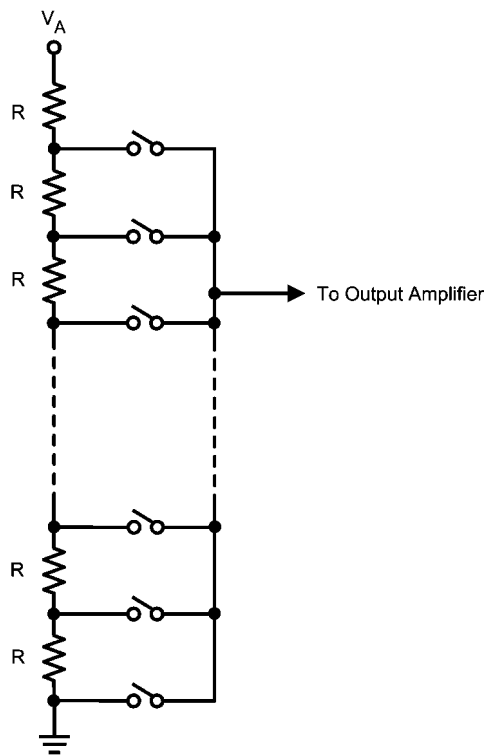

30018007

**FIGURE 3. DAC Resistor String**

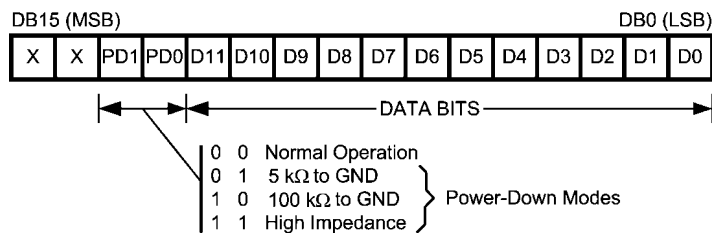

30018008

**FIGURE 4. Input Register Contents**

### 1.3 OUTPUT AMPLIFIER

The output buffer amplifier is a rail-to-rail type, providing an output voltage range of 0V to  $V_A$ . All amplifiers, even rail-to-rail types, exhibit a loss of linearity as the output approaches the supply rails (0V and  $V_A$ , in this case). For this reason, linearity is specified over less than the full output range of the DAC. The output capabilities of the amplifier are described in the Electrical Tables.

### 1.4 SERIAL INTERFACE

The three-wire interface is compatible with SPI, QSPI and MICROWIRE, as well as most DSPs. See the Timing Diagram for information on a write sequence.

A write sequence begins by bringing the  $\overline{\text{SYNC}}$  line low. Once  $\overline{\text{SYNC}}$  is low, the data on the  $D_{IN}$  line is clocked into the 16-bit serial input register on the falling edges of SCLK. On the 16th falling clock edge, the last data bit is clocked in and the programmed function (a change in the mode of operation and/or a change in the DAC register contents) is executed. At this point the  $\overline{\text{SYNC}}$  line may be kept low or brought high. In either case, it must be brought high for the minimum specified time before the next write sequence as a falling edge of  $\overline{\text{SYNC}}$  can initiate the next write cycle.

Since the  $\overline{\text{SYNC}}$  and  $D_{IN}$  buffers draw more current when they are high, they should be idled low between write sequences to minimize power consumption.

### 1.5 INPUT SHIFT REGISTER

The input shift register, *Figure 4*, has sixteen bits. The first two bits are "don't cares" and are followed by two bits that determine the mode of operation (normal mode or one of three power-down modes). The contents of the serial input register are transferred to the DAC register on the sixteenth falling edge of SCLK. See Timing Diagram, *Figure 2*.



Normally, the  $\overline{\text{SYNC}}$  line is kept low for at least 16 falling edges of SCLK and the DAC is updated on the 16th SCLK falling edge. However, if  $\overline{\text{SYNC}}$  is brought high before the 16th falling edge, the shift register is reset and the write sequence is invalid. The DAC register is not updated and there is no change in the mode of operation or in the output voltage.

### 1.6 POWER-ON RESET

The power-on reset circuit controls the output voltage during power-up. Upon application of power the DAC register is filled with zeros and the output voltage is 0 Volts and remains there until a valid write sequence is made to the DAC.

### 1.7 POWER-DOWN MODES

The DAC121S101 has four modes of operation. These modes are set with two bits (DB13 and DB12) in the control register.

**TABLE 1. Modes of Operation**

DB13	DB12	Operating Mode
0	0	Normal Operation
0	1	Power-Down with 5kΩ to GND
1	0	Power-Down with 100kΩ to GND
1	1	Power-Down with Hi-Z

When both DB13 and DB12 are 0, the device operates normally. For the other three possible combinations of these bits the supply current drops to its power-down level and the output is pulled down with either a 5kΩ or a 100kΩ resistor, or is in a high impedance state, as described in [Table 1](#).

The bias generator, output amplifier, the resistor string and other linear circuitry are all shut down in any of the power-down modes. Minimum power consumption is achieved in the power-down mode with SCLK disabled and  $\overline{\text{SYNC}}$  and  $D_{IN}$  idled low.

## 2.0 Applications Information

The simplicity of the DAC121S101 implies ease of use. However, it is important to recognize that any data converter that utilizes its supply voltage as its reference voltage will have essentially zero PSRR (Power Supply Rejection Ratio). Therefore, it is necessary to provide a noise-free supply voltage to the device.

### 2.1 DSP/MICROPROCESSOR INTERFACING

Interfacing the DAC121S101 to microprocessors and DSPs is quite simple. The following guidelines are offered to hasten the design process.

#### 2.1.1 ADSP-2101/ADSP2103 Interfacing

[Figure 5](#) shows a serial interface between the DAC121S101 and the ADSP-2101/ADSP2103. The DSP should be set to operate in the SPORT Transmit Alternate Framing Mode. It is programmed through the SPORT control register and should be configured for Internal Clock Operation, Active Low Framing and 16-bit Word Length. Transmission is started by writing a word to the Tx register after the SPORT mode has been enabled.

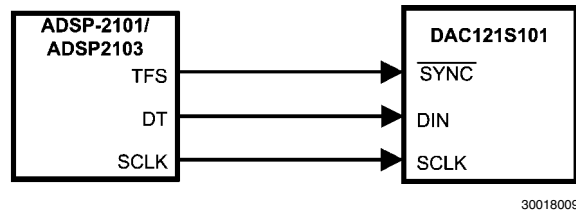

30018009

**FIGURE 5. ADSP-2101/2103 Interface**

#### 2.1.2 80C51/80L51 Interface

A serial interface between the DAC121S101 and the 80C51/80L51 microcontroller is shown in [Figure 6](#). The  $\overline{\text{SYNC}}$  signal comes from a bit-programmable pin on the microcontroller. The example shown here uses port line P3.3. This line is taken low when data is to be transmitted to the DAC121S101. Since the 80C51/80L51 transmits 8-bit bytes, only eight falling clock edges occur in the transmit cycle. To load data into the DAC, the P3.3 line must be left low after the first eight bits are transmitted. A second write cycle is initiated to transmit the second byte of data, after which port line P3.3 is brought high. The 80C51/80L51 transmit routine must recognize that the 80C51/80L51 transmits data with the LSB first while the DAC121S101 requires data with the MSB first.

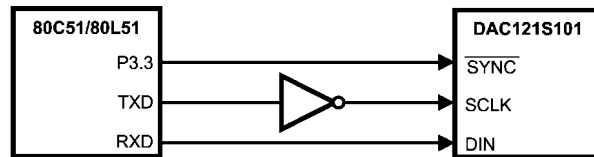

30018010

**FIGURE 6. 80C51/80L51 Interface**

#### 2.1.3 68HC11 Interface

A serial interface between the DAC121S101 and the 68HC11 microcontroller is shown in [Figure 7](#). The  $\overline{\text{SYNC}}$  line of the DAC121S101 is driven from a port line (PC7 in the figure), similar to the 80C51/80L51.

The 68HC11 should be configured with its CPOL bit as a zero and its CPHA bit as a one. This configuration causes data on the MOSI output to be valid on the falling edge of SCLK. PC7 is taken low to transmit data to the DAC. The 68HC11 transmits data in 8-bit bytes with eight falling clock edges. Data is transmitted with the MSB first. PC7 must remain low after the first eight bits are transferred. A second write cycle is initiated to transmit the second byte of data to the DAC, after which PC7 should be raised to end the write sequence.

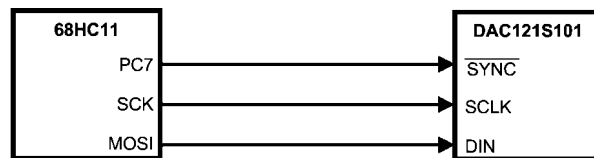

30018011

**FIGURE 7. 68HC11 Interface**

#### 2.1.4 Microwire Interface

[Figure 8](#) shows an interface between a Microwire compatible device and the DAC121S101. Data is clocked out on the rising edges of the SCLK signal.

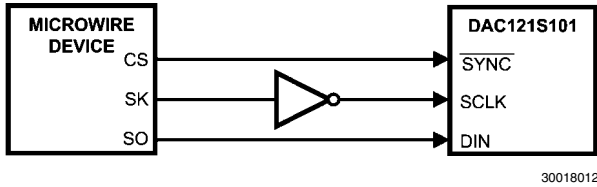

30018012

**FIGURE 8. Microwire Interface**

## 2.2 USING REFERENCES AS POWER SUPPLIES

Recall the need for a quiet supply source for devices that use their power supply voltage as a reference voltage.

Since the DAC121S101 consumes very little power, a reference source may be used as the supply voltage. The advantages of using a reference source over a voltage regulator are accuracy and stability. Some low noise regulators can also be used for the power supply of the DAC121S101. Listed below are a few power supply options for the DAC121S101.

### 2.2.1 LM4130

The LM4130 reference, with its 0.05% accuracy over temperature, is a good choice as a power source for the DAC121S101. Its primary disadvantage is the lack of 3 V and 5 V versions. However, the 4.096 V version is useful if a 0 to 4.095 V output range is desirable or acceptable. Bypassing the LM4130 VIN pin with a 0.1 μF capacitor and the VOUT pin with a 2.2 μF capacitor will improve stability and reduce output noise. The LM4130 comes in a space-saving 5-pin SOT23.

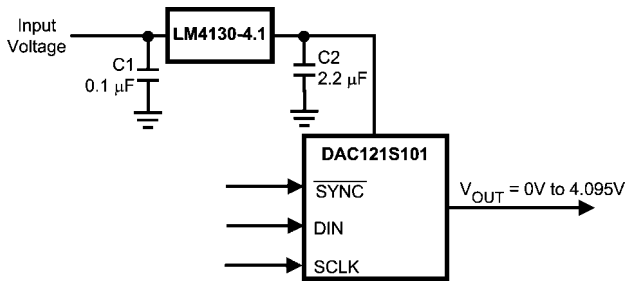

30018013

**FIGURE 9. The LM4130 as a power supply**

### 2.2.2 LM4050

Available with accuracy of 0.44%, the LM4050 shunt reference is also a good choice as a power regulator for the DAC121S101. It does not come in a 3 Volt version, but 4.096 V and 5 V versions are available. It comes in a space-saving 3-pin SOT23.

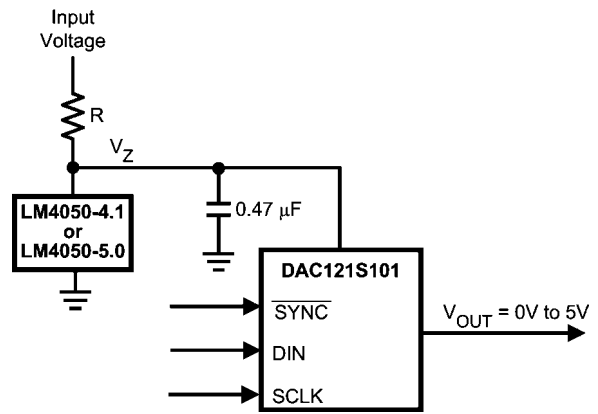

30018014

**FIGURE 10. The LM4050 as a power supply**

The minimum resistor value in the circuit of *Figure 10* should be chosen such that the maximum current through the LM4050 does not exceed its 15 mA rating. The conditions for maximum current include the input voltage at its maximum, the LM4050 voltage at its minimum, the resistor value at its minimum due to tolerance, and the DAC121S101 draws zero current. The maximum resistor value must allow the LM4050 to draw more than its minimum current for regulation plus the maximum DAC121S101 current in full operation. The conditions for minimum current include the input voltage at its minimum, the LM4050 voltage at its maximum, the resistor value at its maximum due to tolerance, and the DAC121S101 draws its maximum current. These conditions can be summarized as

$$R(\min) = (V_{IN}(\max) - V_Z(\min)) / (I_A(\min) + I_Z(\max))$$

and

$$R(\max) = (V_{IN}(\min) - V_Z(\max)) / (I_A(\max) + I_Z(\min))$$

where  $V_Z(\min)$  and  $V_Z(\max)$  are the nominal LM4050 output voltages  $\pm$  the LM4050 output tolerance over temperature,  $I_Z(\max)$  is the maximum allowable current through the LM4050,  $I_Z(\min)$  is the minimum current required by the LM4050 for proper regulation,  $I_A(\max)$  is the maximum DAC121S101 supply current, and  $I_A(\min)$  is the minimum DAC121S101 supply current.

### 2.2.3 LP3985

The LP3985 is a low noise, ultra low dropout voltage regulator with a 3% accuracy over temperature. It is a good choice for applications that do not require a precision reference for the DAC121S101. It comes in 3.0V, 3.3V and 5V versions, among others, and sports a low 30 μV noise specification at low frequencies. Since low frequency noise is relatively difficult to filter, this specification could be important for some applications. The LP3985 comes in a space-saving 5-pin SOT23 and 5-bump micro SMD packages.

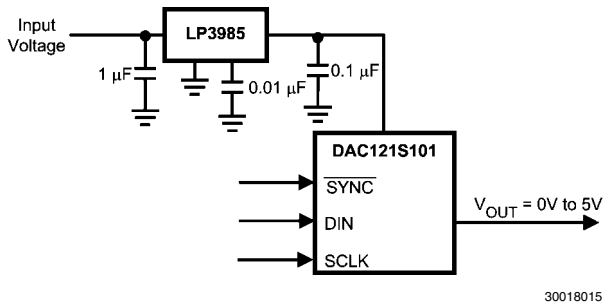

FIGURE 11. Using the LP3985 regulator

An input capacitance of 1.0µF without any ESR requirement is required at the LP3985 input, while a 1.0µF ceramic capacitor with an ESR requirement of 5mΩ to 500mΩ is required at the output. Careful interpretation and understanding of the capacitor specification is required to ensure correct device operation.

#### 2.2.4 LP2980

The LP2980 is an ultra low dropout regulator with a 0.5% or 1.0% accuracy over temperature, depending upon grade. It is available in 3.0V, 3.3V and 5V versions, among others.

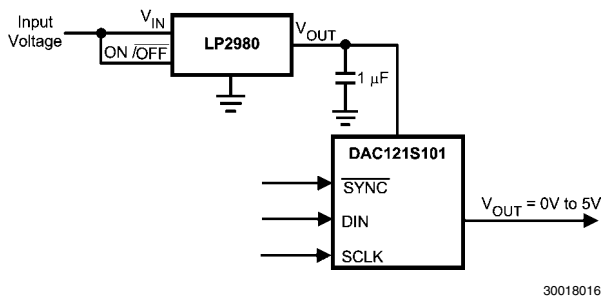

FIGURE 12. Using the LP2980 regulator

Like any low dropout regulator, the LP2980 requires an output capacitor for loop stability. This output capacitor must be at least 1.0µF over temperature, but values of 2.2µF or more will provide even better performance. The ESR of this capacitor should be within the range specified in the LP2980 data sheet. Surface-mount solid tantalum capacitors offer a good combination of small size and ESR. Ceramic capacitors are attractive due to their small size but generally have ESR values that are too low for use with the LP2980. Aluminum electrolytic capacitors are typically not a good choice due to their large size and have ESR values that may be too high at low temperatures.

#### 2.3 BIPOLAR OPERATION

The DAC121S101 is designed for single supply operation and thus has a unipolar output. However, a bipolar output may be obtained with the circuit in [Figure 13](#). This circuit will provide an output voltage range of ±5 Volts. A rail-to-rail amplifier should be used if the amplifier supplies are limited to ±5V.

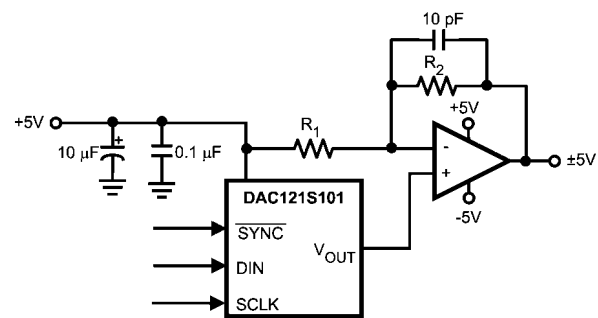

FIGURE 13. Bipolar Operation

The output voltage of this circuit for any code is found to be

$$V_O = (V_A \times (D / 4096) \times ((R_1 + R_2) / R_1) - V_A \times R_2 / R_1)$$

where D is the input code in decimal form. With  $V_A = 5V$  and  $R_1 = R_2$ ,

$$V_O = (10 \times D / 4096) - 5V$$

A list of rail-to-rail amplifiers suitable for this application are indicated in [Table 2](#).

TABLE 2. Some Rail-to-Rail Amplifiers

AMP	PKGS	Typ $V_{OS}$	Typ $I_{SUPPLY}$
LMC7111	DIP-8 SOT23-5	0.9 mV	25 µA
LM7301	SO-8 SOT23-5	0.03 mV	620 µA
LM8261	SOT23-5	0.7 mV	1 mA

#### 2.4 LAYOUT, GROUNDING, AND BYPASSING

For best accuracy and minimum noise, the printed circuit board containing the DAC121S101 should have separate analog and digital areas. The areas are defined by the locations of the analog and digital power planes. Both of these planes should be located in the same board layer. There should be a single ground plane. A single ground plane is preferred if digital return current does not flow through the analog ground area. Frequently a single ground plane design will utilize a "fencing" technique to prevent the mixing of analog and digital ground current. Separate ground planes should only be utilized when the fencing technique is inadequate. The separate ground planes must be connected in one place, preferably near the DAC121S101. Special care is required to guarantee that digital signals with fast edge rates do not pass over split ground planes. They must always have a continuous return path below their traces.

The DAC121S101 power supply should be bypassed with a 10µF and a 0.1µF capacitor as close as possible to the device with the 0.1µF right at the device supply pin. The 10µF capacitor should be a tantalum type and the 0.1µF capacitor should be a low ESL, low ESR type. The power supply for the DAC121S101 should only be used for analog circuits.

Avoid crossover of analog and digital signals and keep the clock and data lines on the component side of the board. The clock and data lines should have controlled impedances.

### 3.0 Radiation Environments

Careful consideration should be given to environmental conditions when using a product in a radiation environment.

#### 3.1 Total Ionizing Dose

Radiation hardness assured (RHA) products are those part numbers with a total ionizing dose (TID) level specified in the Ordering Information table on the front page. Testing and qualification of these products is done on a wafer level according to MIL-STD-883G, Test Method 1019.7, Condition A and the "Extended room temperature anneal test" described in section 3.11 for application environment dose rates less than 0.027 rad(Si)/s. Wafer level TID data is available with lot shipments.

#### 3.2 Single Event Latch-Up and Functional Interrupt

One time single event latch-up (SEL) and single event functional interrupt (SEFI) testing was performed according to EIA/JEDEC Standard, EIA/JEDEC57. The linear energy transfer threshold (LET<sub>th</sub>) shown in the Key Specifications table on the front page is the maximum LET tested. A test report is available upon request.

#### 3.3 Single Event Upset

A report on single event upset (SEU) is available upon request.

## Revision History

Date Released	Revision	Section	Changes
05/05/08	A	Initial Release	New Product Data Sheet Release
08/14/08	B	Ordering Information Table	Removed SMD reference. Added DAC121S101WGMLS NSPN . Revision A will be Archived.
07/15/09	C	Ordering Information Table, AC and Timing Electrical Characteristics	Added SMD reference, removed MLS device. Changed following parameter limits from Max to Min $t_H$ , $t_L$ , $t_{SUCL}$ , $t_{SUD}$ , $t_{DHD}$ , $t_{CS}$ , $t_{SYNC}$ , $t_{SUCL}$ limit from $-21$ to $0$ , Added Delta Parameters. Added subgroups to $f_{SCLK}$ , Removed the typical limits. Changed paragraph's 1.7 and 3.0 section. Revision B will be Archived
05/06/2010	D	Ordering Information Table, Note Section, Operating Life Test Delta Table and Section 3.0 Radiation Environments	Added reference to MPR and CVAL NSPN, verbiage to Note 12, Per DSCC recommendation delta limits for Supply Current. Change to para 3.1, $0.16$ rad(Si)/s to $0.027$ rad(Si)/s. Revision C will be Archived

**Physical Dimensions** inches (millimeters) unless otherwise noted

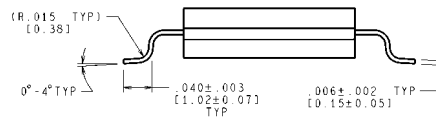
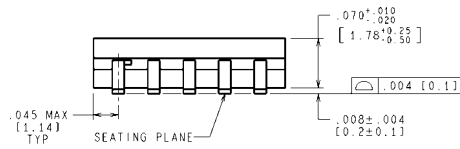
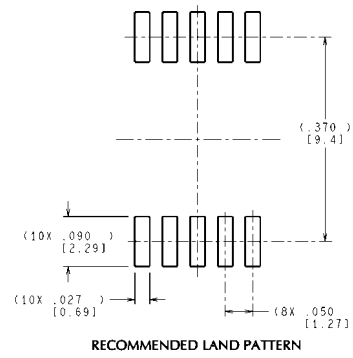
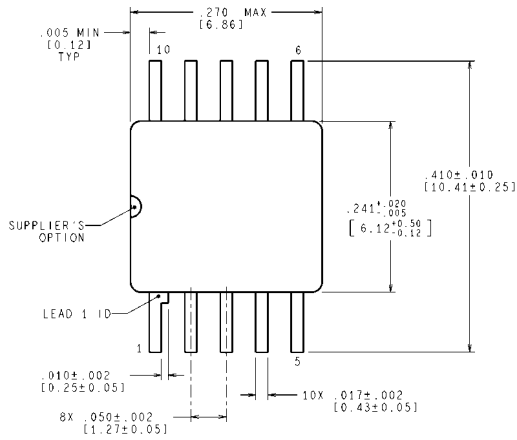

MIL-PRF-38535  
 CONFIGURATION CONTROL

**10-Pin Ceramic SOIC  
 NS Package Number WG10A**

CONTROLLING DIMENSION IS INCH  
 VALUES IN [ ] ARE MILLIMETERS  
 DIMENSIONS IN ( ) FOR REFERENCE ONLY

WG10A (Rev F)

## Notes

## Notes

For more National Semiconductor product information and proven design tools, visit the following Web sites at:  
[www.national.com](http://www.national.com)

Products		Design Support	
Amplifiers	<a href="http://www.national.com/amplifiers">www.national.com/amplifiers</a>	WEBENCH® Tools	<a href="http://www.national.com/webench">www.national.com/webench</a>
Audio	<a href="http://www.national.com/audio">www.national.com/audio</a>	App Notes	<a href="http://www.national.com/appnotes">www.national.com/appnotes</a>
Clock and Timing	<a href="http://www.national.com/timing">www.national.com/timing</a>	Reference Designs	<a href="http://www.national.com/refdesigns">www.national.com/refdesigns</a>
Data Converters	<a href="http://www.national.com/adc">www.national.com/adc</a>	Samples	<a href="http://www.national.com/samples">www.national.com/samples</a>
Interface	<a href="http://www.national.com/interface">www.national.com/interface</a>	Eval Boards	<a href="http://www.national.com/evalboards">www.national.com/evalboards</a>
LVDS	<a href="http://www.national.com/lvds">www.national.com/lvds</a>	Packaging	<a href="http://www.national.com/packaging">www.national.com/packaging</a>
Power Management	<a href="http://www.national.com/power">www.national.com/power</a>	Green Compliance	<a href="http://www.national.com/quality/green">www.national.com/quality/green</a>
Switching Regulators	<a href="http://www.national.com/switchers">www.national.com/switchers</a>	Distributors	<a href="http://www.national.com/contacts">www.national.com/contacts</a>
LDOs	<a href="http://www.national.com/ldo">www.national.com/ldo</a>	Quality and Reliability	<a href="http://www.national.com/quality">www.national.com/quality</a>
LED Lighting	<a href="http://www.national.com/led">www.national.com/led</a>	Feedback/Support	<a href="http://www.national.com/feedback">www.national.com/feedback</a>
Voltage References	<a href="http://www.national.com/vref">www.national.com/vref</a>	Design Made Easy	<a href="http://www.national.com/easy">www.national.com/easy</a>
PowerWise® Solutions	<a href="http://www.national.com/powerwise">www.national.com/powerwise</a>	Applications & Markets	<a href="http://www.national.com/solutions">www.national.com/solutions</a>
Serial Digital Interface (SDI)	<a href="http://www.national.com/sdi">www.national.com/sdi</a>	Mil/Aero	<a href="http://www.national.com/milaero">www.national.com/milaero</a>
Temperature Sensors	<a href="http://www.national.com/tempensors">www.national.com/tempensors</a>	SolarMagic™	<a href="http://www.national.com/solarmagic">www.national.com/solarmagic</a>
PLL/VCO	<a href="http://www.national.com/wireless">www.national.com/wireless</a>	PowerWise® Design University	<a href="http://www.national.com/training">www.national.com/training</a>

THE CONTENTS OF THIS DOCUMENT ARE PROVIDED IN CONNECTION WITH NATIONAL SEMICONDUCTOR CORPORATION ("NATIONAL") PRODUCTS. NATIONAL MAKES NO REPRESENTATIONS OR WARRANTIES WITH RESPECT TO THE ACCURACY OR COMPLETENESS OF THE CONTENTS OF THIS PUBLICATION AND RESERVES THE RIGHT TO MAKE CHANGES TO SPECIFICATIONS AND PRODUCT DESCRIPTIONS AT ANY TIME WITHOUT NOTICE. NO LICENSE, WHETHER EXPRESS, IMPLIED, ARISING BY ESTOPPEL OR OTHERWISE, TO ANY INTELLECTUAL PROPERTY RIGHTS IS GRANTED BY THIS DOCUMENT.

TESTING AND OTHER QUALITY CONTROLS ARE USED TO THE EXTENT NATIONAL DEEMS NECESSARY TO SUPPORT NATIONAL'S PRODUCT WARRANTY. EXCEPT WHERE MANDATED BY GOVERNMENT REQUIREMENTS, TESTING OF ALL PARAMETERS OF EACH PRODUCT IS NOT NECESSARILY PERFORMED. NATIONAL ASSUMES NO LIABILITY FOR APPLICATIONS ASSISTANCE OR BUYER PRODUCT DESIGN. BUYERS ARE RESPONSIBLE FOR THEIR PRODUCTS AND APPLICATIONS USING NATIONAL COMPONENTS. PRIOR TO USING OR DISTRIBUTING ANY PRODUCTS THAT INCLUDE NATIONAL COMPONENTS, BUYERS SHOULD PROVIDE ADEQUATE DESIGN, TESTING AND OPERATING SAFEGUARDS.

EXCEPT AS PROVIDED IN NATIONAL'S TERMS AND CONDITIONS OF SALE FOR SUCH PRODUCTS, NATIONAL ASSUMES NO LIABILITY WHATSOEVER, AND NATIONAL DISCLAIMS ANY EXPRESS OR IMPLIED WARRANTY RELATING TO THE SALE AND/OR USE OF NATIONAL PRODUCTS INCLUDING LIABILITY OR WARRANTIES RELATING TO FITNESS FOR A PARTICULAR PURPOSE, MERCHANTABILITY, OR INFRINGEMENT OF ANY PATENT, COPYRIGHT OR OTHER INTELLECTUAL PROPERTY RIGHT.

### LIFE SUPPORT POLICY

**NATIONAL'S PRODUCTS ARE NOT AUTHORIZED FOR USE AS CRITICAL COMPONENTS IN LIFE SUPPORT DEVICES OR SYSTEMS WITHOUT THE EXPRESS PRIOR WRITTEN APPROVAL OF THE CHIEF EXECUTIVE OFFICER AND GENERAL COUNSEL OF NATIONAL SEMICONDUCTOR CORPORATION.** As used herein:

Life support devices or systems are devices which (a) are intended for surgical implant into the body, or (b) support or sustain life and whose failure to perform when properly used in accordance with instructions for use provided in the labeling can be reasonably expected to result in a significant injury to the user. A critical component is any component in a life support device or system whose failure to perform can be reasonably expected to cause the failure of the life support device or system or to affect its safety or effectiveness.

National Semiconductor and the National Semiconductor logo are registered trademarks of National Semiconductor Corporation. All other brand or product names may be trademarks or registered trademarks of their respective holders.

Copyright© 2010 National Semiconductor Corporation

For the most current product information visit us at [www.national.com](http://www.national.com)



**National Semiconductor Americas Technical Support Center**  
 Email: [support@nsc.com](mailto:support@nsc.com)  
 Tel: 1-800-272-9959

**National Semiconductor Europe Technical Support Center**  
 Email: [europe.support@nsc.com](mailto:europe.support@nsc.com)

**National Semiconductor Asia Pacific Technical Support Center**  
 Email: [ap.support@nsc.com](mailto:ap.support@nsc.com)

**National Semiconductor Japan Technical Support Center**  
 Email: [jpn.feedback@nsc.com](mailto:jpn.feedback@nsc.com)