

# DATA SHEET

## **TDA8740; TDA8740H** Satellite sound circuit with noise reduction

Product specification  
Supersedes data of November 1992  
File under Integrated Circuits, IC02

October 1994

**Philips Semiconductors**



**PHILIPS**

## Satellite sound circuit with noise reduction

## TDA8740; TDA8740H

## FEATURES

- Demodulation of main audio signal using wide band PLL (lock range selectable)
- Demodulation of secondary audio signals using wide band PLL
- HF input selection: two-out-of-eight secondary audio signals can be selected
- Noise reduction of the secondary audio signals
- Output selection: stereo, language 1, language 2, main audio and external
- Mute control
- Line outputs (SCART level).

## APPLICATIONS

- Satellite receivers
- TV sets
- Video recorders.

## GENERAL DESCRIPTION

The TDA8740; TDA8740H is a multi-function sound IC for use in satellite receivers, television sets and video recorders. The pin numbers given in parenthesis throughout this document refer to the QFP44 package.

## QUICK REFERENCE DATA

SYMBOL	PARAMETER	CONDITIONS	MIN.	TYP.	MAX.	UNIT
<b>Supply</b>						
$V_P$	supply voltage		8	12	13.2	V
<b>Main channel</b>						
$V_{IN3(rms)}$	input sensitivity pin 18 (14) (RMS value)	S/N(A) = 40 dB	–	1.0	2.0	mV
$\Delta f_{OM}$	lock range PLL demodulator either or		5.5 10.0	–	7.5 11.5	MHz MHz
$V_{OM}$	output voltage pin 23 (19)		–9	–6	–4	dBV
S/N(A)	signal-to-noise ratio	A-weighted	62	70	–	dB
<b>Secondary channels</b>						
$V_{IN1,IN2}$	input sensitivity pins 2, 4, 6, 8, 10, 12, 14 and 16 (1, 3, 5, 7, 9, 11, 40 and 42) (RMS value)	S/N(A) = 40 dB	–	0.8	1.5	mV
$\Delta f_{OS1,2}$	lock range PLL demodulators		6.0	–	8.5	MHz
$V_{OR,OL}$	output voltage pins 24 and 25 (20 and 21)		–8	–6	–4	dBV
S/N(A)	signal-to-noise ratio	A-weighted	72	80	–	dB
<b>Crosstalk</b>						
$\alpha_{S/M}$	crosstalk from secondary to main channel		–	74	–	dB
$\alpha_{M/S}$	crosstalk from main to secondary channel		–	74	–	dB
$\alpha_{S/S}$	crosstalk between secondary channels		–	74	–	dB

Satellite sound circuit with noise reduction

TDA8740; TDA8740H

ORDERING INFORMATION

TYPE NUMBER	PACKAGE		
	NAME	DESCRIPTION	VERSION
TDA8740	SDIP42	plastic shrink dual in-line package; 42 leads (600 mil)	SOT270-1
TDA8740H	QFP44 <sup>(1)</sup>	plastic quad flat package; 44 leads (lead length 1.3 mm); body 10 × 10 × 1.75 mm	SOT307-2

Note

- When using IR reflow soldering it is recommended that the Drypack instructions in the "Quality Reference Handbook" (order number 9398 510 63011) are followed.

BLOCK DIAGRAM

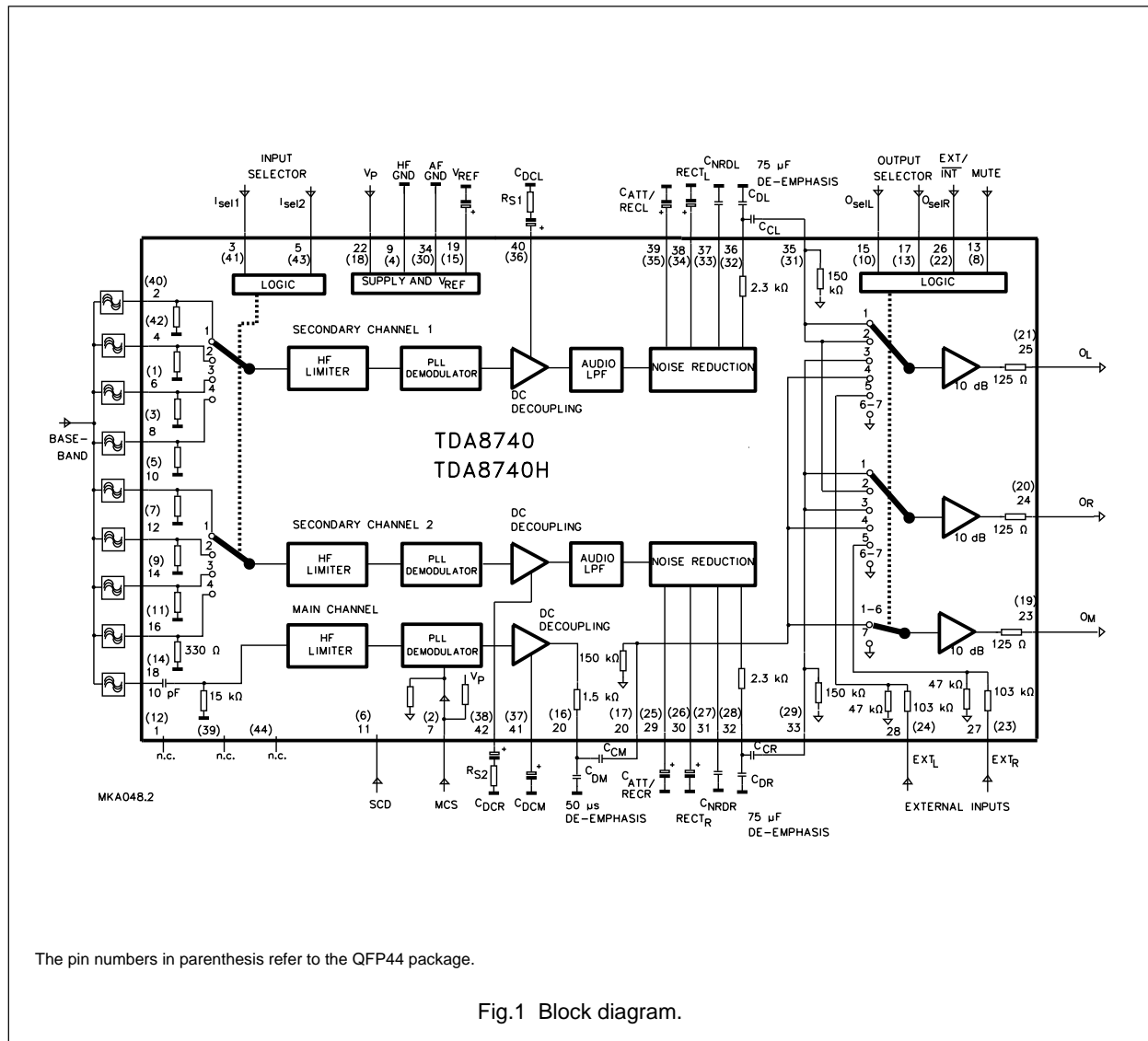

Fig.1 Block diagram.

## Satellite sound circuit with noise reduction

## TDA8740; TDA8740H

## PINNING

SYMBOL	PIN SDIP42	PIN QFP44	DESCRIPTION
n.c.	1	39	not connected
IN-1A	2	40	intercarrier input A for Channel 1 (left)
I <sub>sel 1</sub>	3	41	input select switch bit 1
IN-1B	4	42	intercarrier input B for Channel 1 (left)
I <sub>sel 2</sub>	5	43	input select switch bit 2
IN-1C	6	1	intercarrier input C for Channel 1 (left)
MCS	7	2	main channel PLL lock-in range select/disable
IN-1D	8	3	intercarrier input D for Channel 1 (left)
HFGND	9	4	ground for HF section
IN-2A	10	5	intercarrier input A for Channel 2 (right)
SCD	11	6	secondary channels PLLs disable
IN-2B	12	7	intercarrier input B for Channel 2 (right)
MUTE	13	8	mute switch
IN-2C	14	9	intercarrier input C for Channel 2 (right)
O <sub>sel L</sub>	15	10	output select switch bit 1 (left)
IN-2D	16	11	intercarrier input D for Channel 2 (right)
O <sub>sel R</sub>	17	13	output select switch bit 2 (right)
IN-3	18	14	intercarrier input for main channel
V <sub>REF</sub>	19	15	decoupling capacitor for reference voltage
C <sub>DM</sub>	20	16	de-emphasis capacitor for main channel
C <sub>CM</sub>	21	17	audio pass-through capacitor input for main channel
V <sub>P</sub>	22	18	positive supply voltage
O <sub>M</sub>	23	19	main channel output
O <sub>R</sub>	24	20	right channel output
O <sub>L</sub>	25	21	left channel output
EXT/ $\overline{\text{INT}}$	26	22	output switch bit 3 (external/internal)
EXT <sub>R</sub>	27	23	external audio input (right)
EXT <sub>L</sub>	28	24	external audio input (left)
C <sub>ATT/REC R</sub>	29	25	attack/recovery capacitor (right)
RECT <sub>R</sub>	30	26	rectifier DC decoupling (right)
C <sub>NR D R</sub>	31	27	noise reduction de-emphasis capacitor (right)
C <sub>DR</sub>	32	28	fixed de-emphasis capacitor (right)
C <sub>CR</sub>	33	29	audio pass-through capacitor input for right channel
AFGND	34	30	ground for AF section
C <sub>CL</sub>	35	31	audio pass-through capacitor input for left channel
C <sub>DL</sub>	36	32	fixed de-emphasis capacitor (left)
C <sub>NR D L</sub>	37	33	noise reduction de-emphasis capacitor (left)
RECT <sub>L</sub>	38	34	rectifier DC decoupling (left)
C <sub>ATT/REC L</sub>	39	35	attack/recovery capacitor (left)

## Satellite sound circuit with noise reduction

## TDA8740; TDA8740H

SYMBOL	PIN SDIP42	PIN QFP44	DESCRIPTION
C <sub>DC L</sub>	40	36	DC decoupling capacitor (left)
C <sub>DC M</sub>	41	37	DC decoupling capacitor (main)
C <sub>DC R</sub>	42	38	DC decoupling capacitor (right)
n.c.	–	12	not connected
n.c.	–	44	not connected

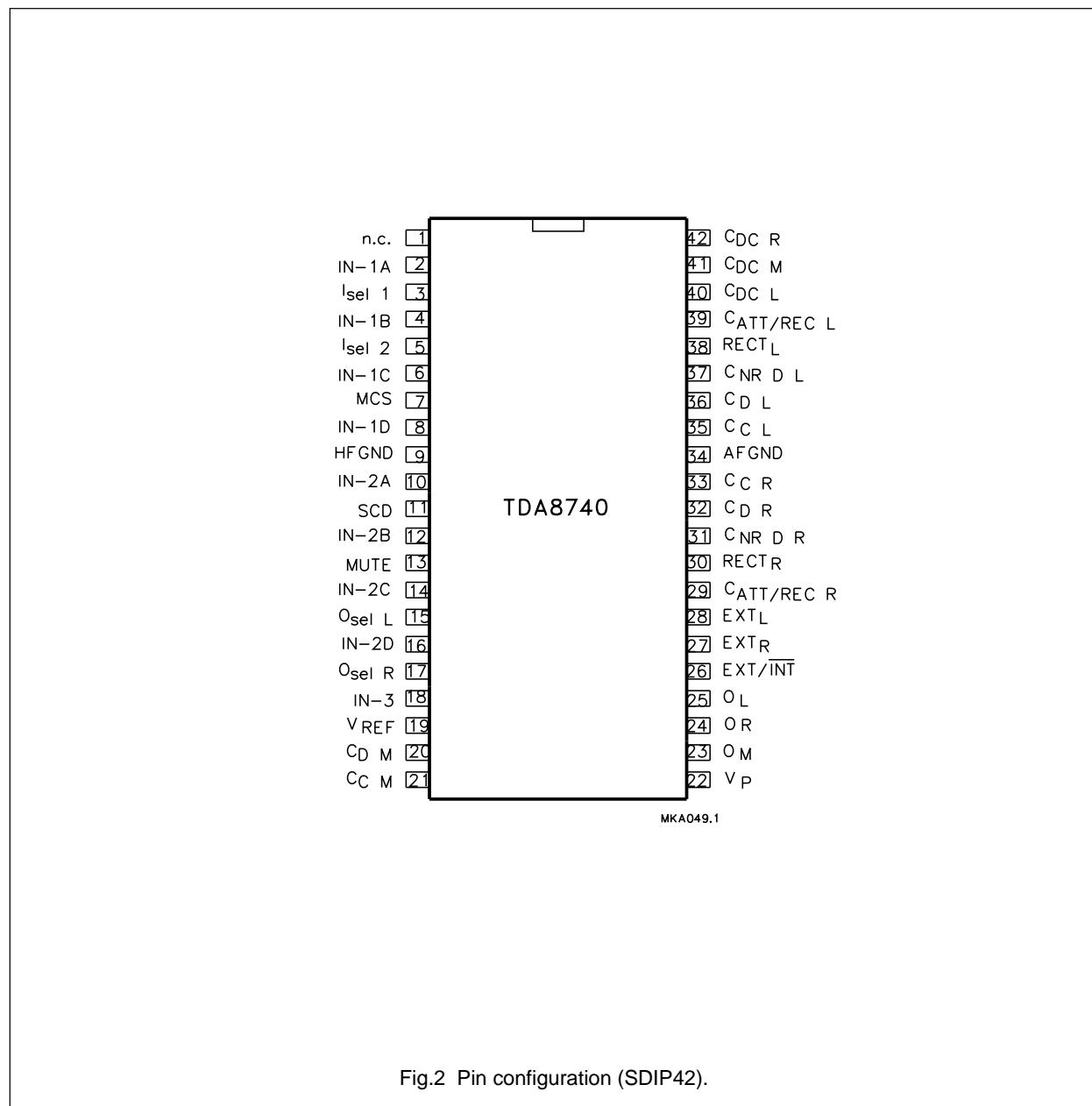

Fig.2 Pin configuration (SDIP42).

Satellite sound circuit with noise reduction

TDA8740; TDA8740H

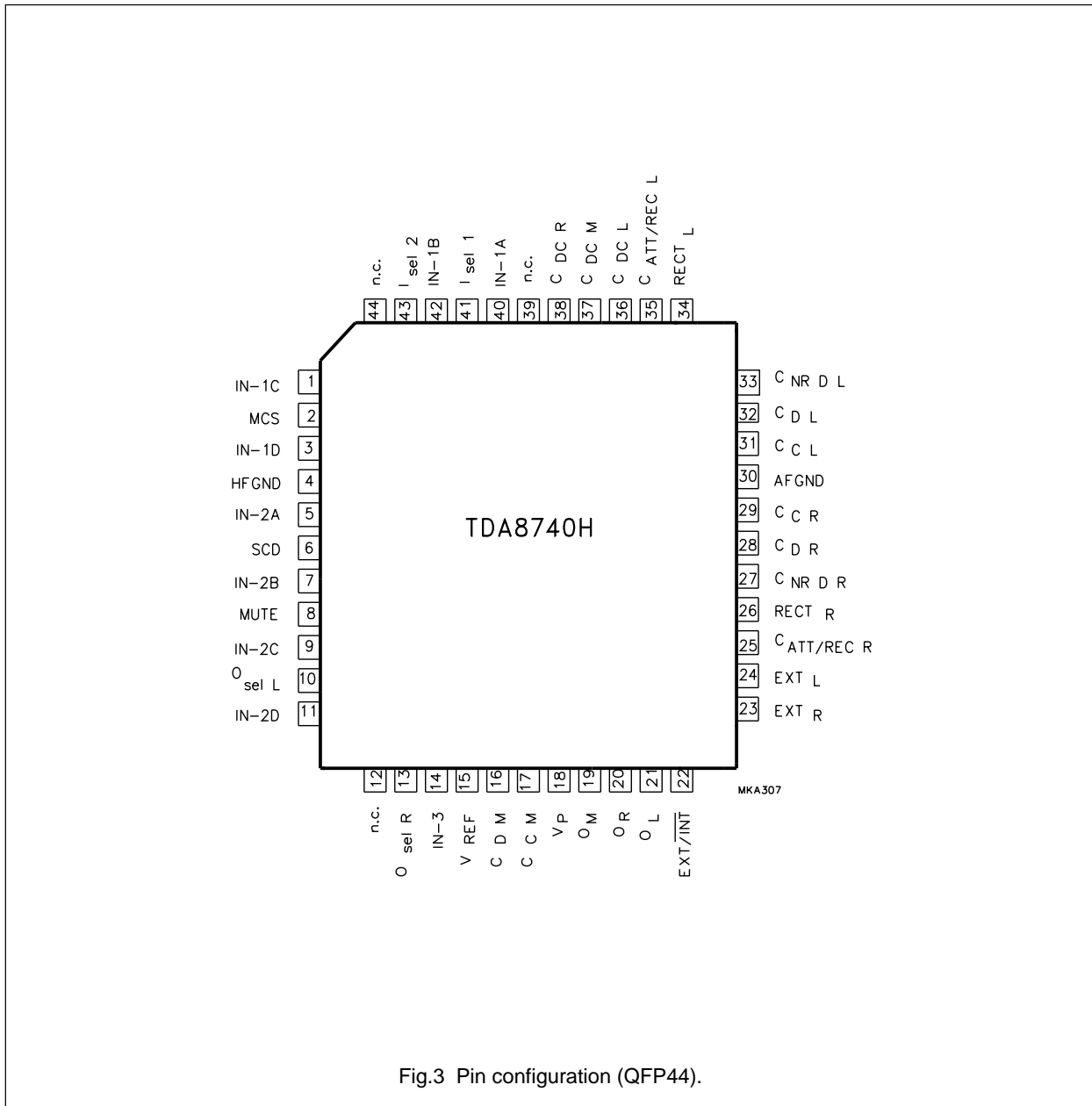

Fig.3 Pin configuration (QFP44).

## Satellite sound circuit with noise reduction

## TDA8740; TDA8740H

### FUNCTIONAL DESCRIPTION

#### Satellite sound

The baseband signal coming from a satellite tuner contains the demodulated video signal plus a number of sound carriers to facilitate reception of a PAL/NTSC/SECAM satellite signal.

Nearest to the video signal is the main sound carrier which carries the single channel sound related to the video. This is an FM modulated carrier with a fixed pre-emphasis. The carrier frequency can be in the range of 5.8 to 6.8 MHz.

Additionally, a number of optional secondary sound carriers may be present which can be used for stereo or multi-language sound related to the video, or for unrelated radio sound. These carriers are also FM modulated, but for better sound quality (improved signal-to-noise performance) broadcast satellites (e.g. 'ASTRA') use a noise reduction system (adaptive pre-emphasis circuit, combined with a fixed pre-emphasis).

These secondary carrier frequencies can be in the range of 6.30 to 8.28 MHz. The TDA8740; H contains all circuitry for processing the main channel and for two secondary channels, from baseband signal to line (SCART) output drivers. The desired frequencies can be routed to the TDA8740; H via bandpass filters.

#### Main channel (see Fig.1)

The lock-in range of the main channel PLL can be switched between 5.5 to 7.5 MHz, PLL off and 10.0 to 11.5 MHz using the MCS signal at pin 7 (2) [when pin 7 (2) is at logic 0, being a voltage from 0 to 1.2 V, the lock-in range = 5.5 to 7.5 MHz; when pin 7 (2) is at logic 1, being a voltage from 3.5 V until  $V_P$ , the lock-in range = 10.0 to 11.5 MHz; when pin 7 (2) is in the mid voltage position, being a voltage from 1.8 to 2.8 V, the main channel PLL is switched off]. The mid voltage position of the MCS pin can also be obtained by a floating MCS pin if the circuit supply voltage  $V_P$  is 10.8 to 13.2 V. The voltage on the MCS pin is then determined by the resistor divider at this pin between  $V_P$  and ground.

If only one fixed carrier frequency for the main channel is to be demodulated (e.g. 6.5 MHz), the lock-in range of the PLL should be switched to 5.5 to 7.5 MHz. The baseband signal is applied to the main channel input, pin 18 (14) via a 6.5 MHz ceramic bandpass filter. Alternatively, if there is a requirement to demodulate different main channel frequencies, these frequencies can be transferred to a fixed intermediate frequency (e.g. 10.7 MHz) using an external mixer and oscillator-frequency synthesizer. In this event the lock-in range of the PLL should be switched to

10.0 to 11.5 MHz. The IF signal is applied to the main channel input, pin 18 (14) via a 10.7 MHz ceramic bandpass filter.

The filtered signal is AC-coupled to a limiter/amplifier and then to a PLL demodulator. The PLL FM demodulator ensures that the demodulator is alignment-free. High gain and DC error signals from the PLL, which are superimposed on the demodulator output, require DC decoupling. A buffer amplifier is used to amplify the signal to the same level as the secondary channels and decouples DC using an electrolytic capacitor connected to pin 41 (37). The demodulator output signal is fed to pin 20 (16) via an internal resistor. The output signal can be de-emphasized by means of this resistor and an external capacitor connected to ground.

Capacitor value = de-emphasis time constant per 1500 (for 50  $\mu$ s: 33 nF).

From here the signal is fed to the output selectors. The signal is amplified to 500 mV (RMS) (i.e. -6 dBV) in the output amplifiers.

#### Secondary channels

Up to eight secondary channel inputs are available at pins 2, 4, 6, 8, 10, 12, 14 and 16 (1, 3, 5, 7, 9, 11, 40 and 42). External ceramic bandpass filters tuned to the required secondary sound carrier frequencies route these signals to the inputs.

For stereo applications the TDA8740; TDA8740H contains two identical secondary sound processing channels. For each channel it is possible to select from four inputs (IN-A, IN-B, IN-C and IN-D) using the input selector (see Logic Table 1). With the input switch several stereo signals or languages can be selected for demodulation. It should be noted that the inputs are identical and can be freely interchanged. Secondary Channel 1 will also be referred to as 'LEFT' or 'LANGUAGE 1' and secondary Channel 2 will also be referred to as 'RIGHT' or 'LANGUAGE 2'.

From the input selector switch the signals are coupled to limiter/amplifiers and then to the PLL demodulators. Processing is similar to the main channel. The demodulator output signal is amplified in a buffer amplifier and DC decoupled using electrolytic capacitors connected to pins 40 (36) (left) and 42 (38) (right). The output level is set with a 220  $\Omega$  resistor connected in series with the capacitor.

High frequency components in the amplified PLL output signal are filtered out in the audio LPF block (4th order Butterworth low-pass filter) to prevent unwanted influence on the noise reduction.

## Satellite sound circuit with noise reduction

## TDA8740; TDA8740H

### NOISE REDUCTION (NR)

The noise reduction can be regarded as an input level-dependent low-pass filter (adaptive de-emphasis system) followed by a fixed de-emphasis. With maximum input level (0 dB) the frequency response of the first part (i.e. without the fixed de-emphasis) is virtually flat. As the input level is lowered by x-dB, the higher output frequencies will be reduced an extra x-dB with respect to the lower frequencies (1 : 2 expansion).

The NR output signal is fed to pin 36 (32) (left) and pin 32 (28) (right) via internal resistors.

Fixed de-emphasis is achieved by these resistors and external capacitors connected to ground. The signals are DC decoupled via pins 36/35 (32/31) and 32/33 (28/29) and then routed to the output selectors.

### OUTPUT SELECTION

With the output selector (see Table 2) the outputs at pins 25 and 24 (21 and 20) can be switched to the different channels. Both outputs can be switched to both secondary channels, to the main channel and to the external inputs at pin 28 and 27 (24 and 23) for IC chaining purposes.

Pin 23 (19) is a separate output which delivers the main channel only, thereby creating the possibility of having three different output channels simultaneously e.g. for use in hi-fi VCRs.

The outputs at pins 25 and 24 (21 and 20) can be muted by setting the MUTE signal at pin 13 (8) to logic 1 (switch positions 6 and 7).

The output at pin 23 (19) can be muted by setting the MUTE signal and the EXT/INT signal at pin 26 (22) both logic 1 (switch position 7).

All outputs at pins 23, 24 and 25 (19, 20 and 21) are line drivers with SCART level capability and are short-circuit protected by 125  $\Omega$  output resistors.

Output level of all channels = -6 dBV typical when frequency deviation of FM signal is 54% of maximum frequency deviation (i.e.  $0.54 \times 85 \text{ kHz} = 46 \text{ kHz}$  for the main channel and  $0.54 \times 50 \text{ kHz} = 27 \text{ kHz}$  for the secondary channels) at 1 kHz modulation frequency (reference level).

### ABBREVIATIONS

$f_{\text{MOD}}$  = modulating frequency.

$\Delta f_{\text{M}}$  = frequency deviation of the main Channel.

$\Delta f_{\text{S1}}$  = frequency deviation of secondary Channel 1 (left).

$\Delta f_{\text{S2}}$  = frequency deviation of secondary Channel 2 (right).

$f_{\text{OM}}$  = carrier frequency of main Channel.

$f_{\text{OS1}}$  = carrier frequency of secondary Channel 1.

$f_{\text{OS2}}$  = carrier frequency of secondary Channel 2.

LPF = Low-Pass Filter.

NR = Noise Reduction.

PLL = Phase-Locked-Loop



## Satellite sound circuit with noise reduction

## TDA8740; TDA8740H

**LIMITING VALUES**

In accordance with the Absolute Maximum Rating System (IEC 134).

SYMBOL	PARAMETER	CONDITIONS	MIN.	MAX.	UNIT
$V_P$	supply voltage	note 1	0	13.2	V
$V_n$	voltage on pins 2, 4, 6, 8, 10, 12, 14 and 16 (1, 3, 5, 7, 9, 11, 40 and 42)	note 2	0	1	V
$V_n$	voltage on pins 3, 5, 11, 13, 15, 17, 20, 21, 23 to 26, 31, 33, 35, 37, 40, 41, and 42 (6, 8, 10, 13, 16, 17, 19, 20 to 22, 27, 29, 31, 33, 36, 37, 38, 41 and 43)	note 2	0	9	V
$V_n$	voltage on pins 7, 18, 19, 27 to 30, 32, 36, 38 and 39 (2, 14, 15, 23 to 26, 28, 32, 34 and 35)	note 1	0	$V_P$	V
$T_{stg}$	storage temperature		-55	+150	°C
$T_{amb}$	operating ambient temperature		-20	+70	°C

**Notes**

- All voltages referenced to ground pins 9 and 34 (4 and 30).
- All voltages referenced to ground pins 9 and 34 (4 and 30). These voltages must not exceed  $V_P$  or maximum value at any time.

**THERMAL CHARACTERISTICS**

SYMBOL	PARAMETER	VALUE	UNIT
$R_{th\ j-a}$	thermal resistance from junction to ambient in free air		
	SDIP42	53	K/W
	QFP44	69	K/W

**DC CHARACTERISTICS**

All voltages referenced to ground at pins 9 and 34 (4 and 30). Measured in test circuit Fig.4;  $V_P = 12\text{ V}$ ;  $T_{amb} = 25\text{ °C}$ ;  $\Delta f_M = \Delta f_{S1} = \Delta f_{S2} = 0\text{ kHz}$  (no modulation);  $f_{OM} = 6.5\text{ MHz}$ ;  $f_{OS1} = 7.02\text{ MHz}$ ;  $f_{OS2} = 7.20\text{ MHz}$ ; HF level at pin 18 (14): 40 mV (RMS); HF level at selected secondary inputs: 20 mV (RMS); MCS = logic 0 [ $V_7$  ( $V_2$ ) = 0 V]; SCD = logic 0 [ $V_{11}$  ( $V_6$ ) = 0 V]; unless otherwise specified.

SYMBOL	PARAMETER	MIN.	TYP.	MAX.	UNIT
$V_P$	supply voltage	8.0	12	13.2	V
$I_P$	supply current	–	38	45	mA
$P_{tot}$	total power dissipation	–	–	600	mW
$V_n$	voltage on pins 20, 21, 23, 24, 25, 27, 28, 30, 32, 33, 35, 36 and 38 (16, 17, 19, 20, 21, 23, 24, 26, 28, 29, 31, 32 and 34)	–	3.8	–	V
$V_{REF}$	input reference voltage on pin 19 (15)	3.7	3.8	3.9	V
$V_n$	voltage on pins 2, 4, 6, 8, 10, 12, 14 and 16 (1, 3, 5, 7, 9, 11, 40 and 42)	–	0	–	V
$V_{CDCL, CDCR}$	voltage on pins 40 and 42 (36 and 38)	–	2.7	–	V
$V_{CDCM}$	voltage on pin 41 (37)	–	2.8	–	V
$I_{IN3}$	input current at pin 18 (14)	–	–	1	μA

## Satellite sound circuit with noise reduction

## TDA8740; TDA8740H

**AC CHARACTERISTICS**

All voltages referenced to ground at pins 9 and 34 (4 and 30). Measured in test circuit Fig.4;  $V_P = 12\text{ V}$ ;  $T_{\text{amb}} = 25\text{ }^\circ\text{C}$ ;  $f_{\text{MOD}} = 1\text{ kHz}$ ;  $f_{\text{OM}} = 6.5\text{ MHz}$ ;  $\Delta f_M = 46\text{ kHz}$ ;  $\Delta f_{S1} = \Delta f_{S2} = 27\text{ kHz}$  (reference levels);  $f_{\text{OS1}} = 7.02\text{ MHz}$ ;  $f_{\text{OS2}} = 7.20\text{ MHz}$ ; HF level at pin 18 (14): 40 mV (RMS); HF level at selected secondary inputs: 20 mV (RMS); MCS = logic 0 [ $V_7$  ( $V_2$ ) = 0 V]; SCD = logic 0 [ $V_{11}$  ( $V_6$ ) = 0 V]; unless otherwise specified.

SYMBOL	PARAMETER	CONDITIONS	MIN.	TYP.	MAX.	UNIT
<b>Main channel - HF input pin 18 (14) and limiter</b>						
$V_{\text{IN3(rms)}}$	input sensitivity (RMS value)	S/N(A) = 40 dB	–	1.0	2.0	mV
$V_{\text{IN3(rms)}}$	input signal level (RMS value)		–	–	200	mV
$R_{\text{IN3}}$	input resistance		–	15	–	k $\Omega$
<b>Main channel - PLL FM demodulator and DC decoupling amplifier</b>						
$f_{\text{CCO}}$	free-running frequency		–	6.5	–	MHz
		MCS = logic 1	–	10.7	–	MHz
$\Delta f_{\text{OM}}$	lock range of PLL	note 1	5.5	–	7.5	MHz
		MCS = logic 1; note 1	10.0	–	11.5	MHz
$R_{\text{CDM}}$	output resistance for 50 $\mu\text{s}$ de-emphasis pin 20 (16)		1.24	1.5	1.7	k $\Omega$
$V_{\text{CDM}}$	output voltage pin 20 (16)		–18.5	–16.0	–14.5	dBV
$\Delta V_{\text{CDM}}$	spread of PLL output voltage over lock range pin 20 (16)		–	–	$\pm 1$	dB
$R_{\text{CCM}}$	input resistance of output amplifier pin 21 (17)		95	150	200	k $\Omega$
<b>Main channel - overall performance (output selector in position 4)</b>						
$V_{\text{OM,OR,OL}}$	output voltage pins 23, 24 and 25 (19, 20 and 21)	all PLLs locked	–9	–6	–4	dBV
UBM	output voltage unbalance pins 23, 24, 25 (19, 20, 21)	output selector in position 4	–0.5	–	+0.5	dB
THD	total harmonic distortion	all PLLs locked	–	0.1	0.5	%
S/N(A)	signal-to-noise ratio	A-weighted; all PLLs locked	62	70	–	dB
$\frac{V_{\text{OM}(15\text{ kHz})}}{V_{\text{OM}(1\text{ kHz})}}$	15 kHz frequency response with respect to 1 kHz pin 23 (19)	no de-emphasis connected	–0.5	0	+0.5	dB
$R_{\text{OM,OR,OL}}$	output resistance pins 23, 24 and 25 (19, 20 and 21)		92	125	150	$\Omega$
$\alpha_{\text{S/M}}$	crosstalk attenuation from secondary channels to main	note 2	–	74	–	dB
MUTE <sub>att</sub>	mute attenuation	output selector in position 7	74	–	–	dB
SVRR	supply voltage ripple rejection	$V_{\text{RR}} = 100\text{ mV}$ ; $f_i = 70\text{ Hz}$	–	35	–	dB

## Satellite sound circuit with noise reduction

## TDA8740; TDA8740H

SYMBOL	PARAMETER	CONDITIONS	MIN.	TYP.	MAX.	UNIT
<b>Secondary channels 1 and 2 - HF inputs pins 2, 4, 6, 8, 10, 12, 14 and 16 (1, 3, 5, 7, 9, 11, 40 and 42) and limiters</b>						
$V_{IN1,IN2}$	input sensitivity (RMS value)	S/N(A) = 40 dB	–	0.8	1.5	mV
$V_{I(rms)}$	input signal level (RMS value)		–	–	200	mV
$R_i$	input resistance		260	330	380	$\Omega$
<b>Secondary channels 1 and 2 - PLL FM demodulators (input selector in position 1)</b>						
$f_{CCO1}$	free running frequency PLL1		–	7.0	–	MHz
$f_{CCO2}$	free running frequency PLL2		–	7.2	–	MHz
$\Delta f_{OS1/2}$	lock range of PLLs	note 3	6.0	–	8.5	MHz
$R_{S1,S2}$	series resistance for optimum frequency response adjustment		0	0.22	1.0	$k\Omega$
$V_{CDCL,CDCR (rms)}$	PLL output voltage pins 40 and 42 (36 and 38) (RMS value)	pins to be left open-circuit	–	7	–	mV
$\Delta V_{CDCL,CDCR}$	spread of PLL output voltage over lock range		–	–	$\pm 1$	dB
<b>Secondary channels - overall performance of LPF and NR (input and output selectors in position 1)</b>						
$R_o$	output resistance for 75 $\mu$ s de-emphasis pins 36 and 32 (32 and 28)		1.9	2.3	2.6	$k\Omega$
$R_i$	input resistance of output amplifiers pins 35 and 33 (31 and 29)		95	150	200	$k\Omega$
$V_{OL,OR}$	output voltage level pins 25 and 24 (21 and 20)	note 4	–8	–6	–4	dBV
UBS	unbalance voltage outputs pins 25 and 24 (21 and 20)	note 4	–1	–	+1	dBV
THD	total harmonic distortion	note 4	–	0.1	0.5	%
S/N(A)	signal-to-noise ratio	A-weighted; note 4	72	80	–	dB
$R_o$	output resistance pins 25 and 24 (21 and 20)	note 4	92	125	150	$\Omega$
$MUTE_{att}$	mute attenuation	output selector in position 6; note 4	74	–	–	dB
$\alpha_{S/S}$	crosstalk attenuation between secondary channels	note 5	–	74	–	dB
$\alpha_{M/S}$	crosstalk attenuation from main channel to secondary	note 6	–	74	–	dB
$V_{offset(DC)}$	DC offset voltage on attack/recovery capacitors pins 29, 39 (25, 35)	all PLLs locked; $\Delta f = 0$	14	16	20	mV
SVRR	supply voltage ripple rejection	$V_{RR} = 100$ mV; $f_i = 70$ Hz	–	25	–	dB

## Satellite sound circuit with noise reduction

## TDA8740; TDA8740H

SYMBOL	PARAMETER	CONDITIONS	MIN.	TYP.	MAX.	UNIT
<b>Secondary channels - low-pass filter pins 38 and 30 (34 and 26)</b>						
$\frac{V_{\text{RECTL, RECTR}}(50 \text{ kHz})}{V_{\text{RECTL, RECTR}}(1 \text{ kHz})}$	50 kHz frequency response with respect to 1 kHz	note 7	-25	-16	-9	dB
<b>Secondary channels - noise reduction pins 25 and 24 (21 and 20); note 4</b>						
$V_{\text{OL,OR}}$	output voltage at 0 dB noise reduction input level	$\Delta f_{\text{S1}} = \Delta f_{\text{S2}} = 50 \text{ kHz}$ ; no fixed de-emphasis connected	-1	+1	+3	dBV
$\frac{V_{\text{OL,OR}}(15 \text{ kHz})}{V_{\text{OL,OR}}(1 \text{ kHz})}$	15 kHz frequency response with respect to 1 kHz at 0 dB noise reduction input level	$\Delta f_{\text{S1}} = \Delta f_{\text{S2}} = 50 \text{ kHz}$ ; no fixed de-emphasis connected	-2	0	+2	dB
$V_{\text{OL,OR}}$	output voltage at -20 dB noise reduction input level	$\Delta f_{\text{S1}} = \Delta f_{\text{S2}} = 5 \text{ kHz}$ ; no fixed de-emphasis connected	-29	-26	-23	dBV
$\frac{V_{\text{OL,OR}}(15 \text{ kHz})}{V_{\text{OL,OR}}(1 \text{ kHz})}$	15 kHz frequency response with respect to 1 kHz at -20 dB noise reduction input level	$\Delta f_{\text{S1}} = \Delta f_{\text{S2}} = 5 \text{ kHz}$ ; no fixed de-emphasis connected	-13	-11.5	-10	dB
<b>External inputs - pin 28 (24) (left) and pin 27 (23) (right) - overall performance (output selector in position 5)</b>						
$V_{\text{EXTR,EXTL}}$	input signal level		-	-	6	dBV
$R_i$	input resistance		95	150	200	k $\Omega$
$V_{\text{OL,OR}}$	output level pins 25 and 24 (21 and 20)	$V_{\text{EXTR,EXTL}} = -6 \text{ dBV}$	-6.5	-6.0	-5.5	dBV
THD	total harmonic distortion	$V_{\text{EXTR,EXTL}} = -6 \text{ dBV}$ ; $f_i = 1 \text{ kHz}$	-	-	0.1	%
S/N(A)	signal-to-noise ratio	A-weighted; $V_{\text{EXTR,EXTL}} = -6 \text{ dBV}$	80	-	-	dB
$\alpha_{\text{L/R}}, \alpha_{\text{R/L}}$	crosstalk	$f_i = 1 \text{ kHz}$	-	80	-	dB
<b>Input selector control circuit pins 3 and 5 (41 and 43) (see also Table 1) and secondary channels PLLs disable [SCD pin 11 (6)]; pins 3, 5 and 11 (41, 43 and 6) left open-circuit = logic HIGH</b>						
$V_{\text{IL}}$	LOW level input voltage		0	-	1.2	V
$V_{\text{IH}}$	HIGH level input voltage		3.5	-	9	V
$R_i$	input resistance	connected to $V_p$	65	100	130	k $\Omega$

## Satellite sound circuit with noise reduction

## TDA8740; TDA8740H

SYMBOL	PARAMETER	CONDITIONS	MIN.	TYP.	MAX.	UNIT
<b>Output selector control circuit (see also Table 2) and main channel PLL lock-in select [MCS pin 7 (2)]; pins 15, 17, 26 and 13 (10, 13, 22 and 8) are MOS inputs and should not be left open-circuit</b>						
$V_{IL}$	LOW level input voltage limits		0	–	1.2	V
$V_{IM}$	MID level input voltage limits for MCS pin only		1.8	–	2.8	V
$V_{IMF}$	MID level input voltage on MCS pin if MCS pin is floating	$V_P$ must be 10.8 to 13.2 V	17	19	21	% $V_P$
$V_{IH}$	HIGH level input voltage limits		3.5	–	$V_P$	V
$R_{IL}$	low input resistance MCS pin to ground		12	19	26	k $\Omega$
$R_{IH}$	high input resistance MCS pin to $V_P$		52	80	108	k $\Omega$
$I_{IL}$	LOW level input current (not MCS pin)	$V_{IL} = 0$ V	–	<–1	–	$\mu$ A
$I_{IH}$	HIGH level input current (not MCS pin)	$V_{IH} = 5$ V	–	<1	–	$\mu$ A

**Notes**

- At pin 20 (16) the demodulated 1 kHz signal should be present with a typical level of 158 mV (RMS) (–16 dBV), and THD of maximum 0.5%;  $V_P = 8$  to 13.2 V;  $T_{amb} = -20$  to +70 °C.
- Modulation of main channel is OFF; modulation of secondary channels is ON.
- The electrolytic capacitors at pins 40 and 42 (36 and 38) are removed and 1500 pF capacitors between pin 40 (36) and ground and between pin 42 (38) and ground are connected. At pins 40 and 42 (36 and 38) the demodulated 1 kHz signals should be present with typical levels of 7 mV (RMS) and THD of maximum 0.5%;  $V_P = 8$  to 13.2 V;  $T_{amb} = -20$  to +70 °C.
- All PLLs locked;  $R_{S1} = R_{S2} = 220$  k $\Omega$ .
- Modulation of secondary channel being measured and main channel is OFF; modulation of other secondary channel is ON.
- Modulation of main channel is ON; modulation of secondary channels is OFF.
- Measured at pins 38 (34) (left) and 30 (26) (right) and no electrolytic capacitors connected to these pins.

## Satellite sound circuit with noise reduction

## TDA8740; TDA8740H

**Table 1** Truth table for input selection.

SWITCH POSITION	STATE	PIN 15 (10)	PIN 17 (13)
1	pins 2 and 10 (IN-A) (40 and 5)	0	0
2	pins 4 and 12 (IN-B) (42 and 7)	0	1
3	pins 6 and 14 (IN-C) (1 and 9)	1	0
4	pins 8 and 16 (IN-D) (3 and 12)	1	1

**Table 2** Truth table for output selection (note 1).

SWITCH POSITION	STATE	PIN 15 (10)	PIN 17 (13)	PIN 26 (22)	PIN 13 (8)
		OUTSEL L	OUTSEL R	EXT/ $\overline{\text{INT}}$	MUTE
1	stereo	1	1	0	0
2	left	1	0	0	0
3	right	0	1	0	0
4	main	0	0	0	0
5	external	X	X	1	0
6	mute secondary	X	X	0	1
7	mute all	X	X	1	1

**Note**

1. X = don't care.

Satellite sound circuit with noise reduction

TDA8740; TDA8740H

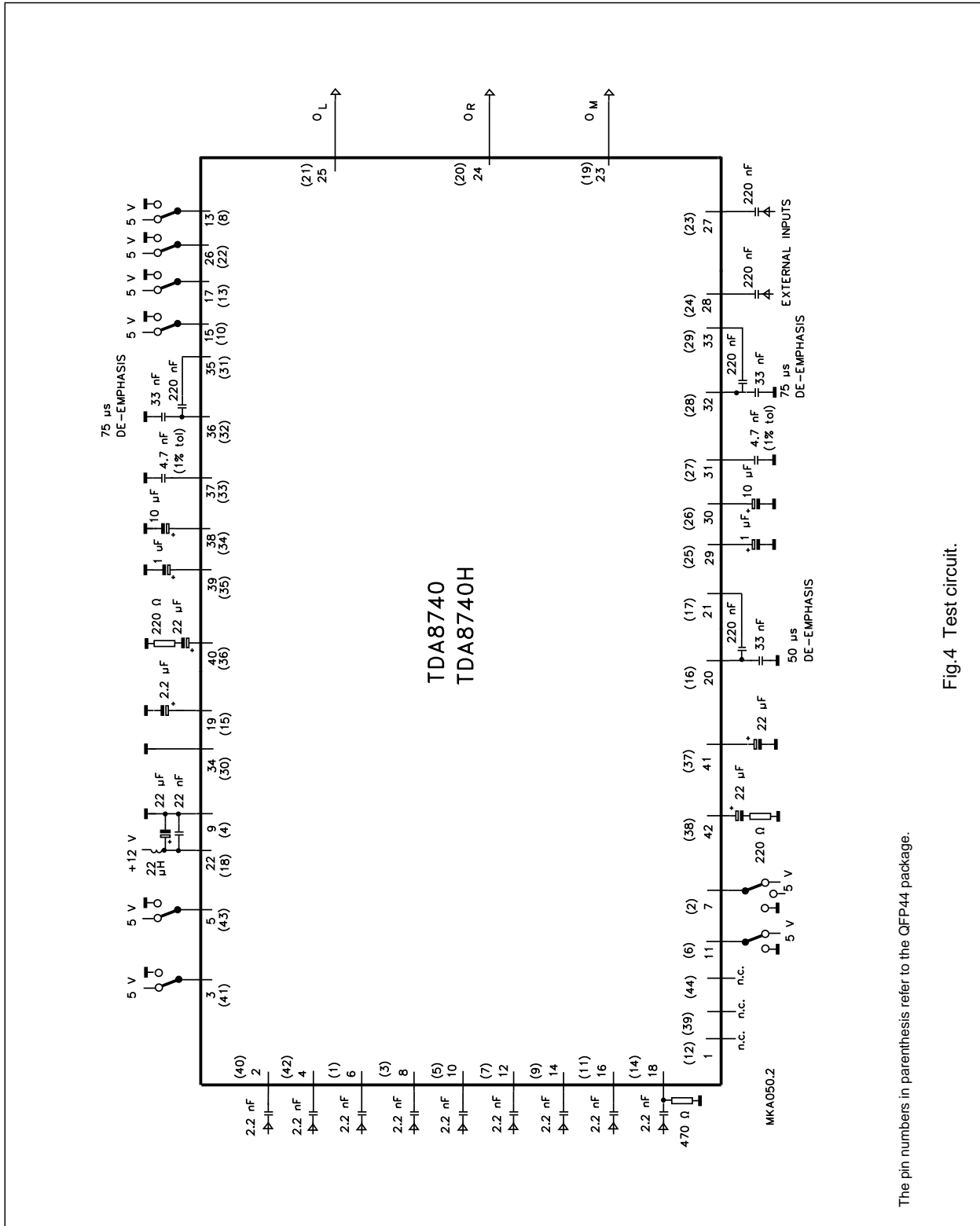

Fig.4 Test circuit.

The pin numbers in parenthesis refer to the QFP44 package.

---

## Satellite sound circuit with noise reduction

## TDA8740; TDA8740H

---

### APPLICATION INFORMATION

#### MCS pin 7 (2) = logic 0; (see Fig.5)

The lock-in range of the main channel PLL is 5.5 to 7.5 MHz. The satellite baseband signal is routed to nine bandpass filters, eight for the secondary channels and one for the main channel. For the secondary channels the bandpass filter terminating resistors are integrated on-chip (330  $\Omega$  typically) so no external resistors are required. For the main channel this is not the case therefore filters with different characteristics can be used.

If the main channel only is to be demodulated the PLLs of the secondary channels can be disabled by setting SCD pin 11 (6) to logic 1.

#### MCS pin 7 (2) = logic 1; (see Fig.6)

The lock-in range of the main channel PLL is now 10.0 to 11.5 MHz. The carrier frequency for the main channel is transposed to 10.7 MHz by an external frequency synthesizer and mixer; e.g., if a 6.65 MHz carrier is to be demodulated this frequency is mixed to 10.7 MHz by tuning the frequency synthesizer to 17.35 MHz. If the synthesizer is tuned 17.20 MHz a 6.5 MHz carrier can be demodulated. In this event the audio output level should be adjusted to -6 dBV by inserting a 470  $\Omega$  resistor in series with the electrolytic capacitor to pin 41 (37).

#### MCS pin 7 (2) = MID position

The main channel PLL is off if the voltage is between 1.8 and 2.8 V on pin 7 (2). This situation can be obtained by a floating MCS pin if  $V_P$  is between 10.8 and 13.2 V or by forcing this MCS pin to the desired voltage by an external voltage source. In that event  $V_P$  can be in the full range of 8 to 13.2 V. This feature can be used to slightly improve the signal-to-noise ratio of the secondary channels if the main channel is not used.

For the main channel the baseband signal is routed to the mixer, and to eight ceramic bandpass filters for the secondary channels. For high-end applications the input level of the NR can be adjusted to give optimal performance. 0 dB is the maximum input level which corresponds to the maximum frequency deviation of the incoming FM signal (50 kHz for secondary channels). If the NR input signal is too low (HIGH) the NR will attenuate (favour) the higher audio frequencies too much due to the expansion character. In general a 1 dB error in the NR input level will give a 1 dB difference between LOW (50 Hz) and HIGH (15 kHz) audio frequencies. With  $R_{S1}$  ( $R_{S2}$ ) the input level and so the frequency response of the NR can be adjusted: at 0 dB input level (which corresponds to a frequency deviation of 50 kHz) the output level of a 15 kHz modulated signal should be 0.25 dB lower than that of a 50 Hz modulated signal.



Satellite sound circuit with noise reduction

TDA8740; TDA8740H

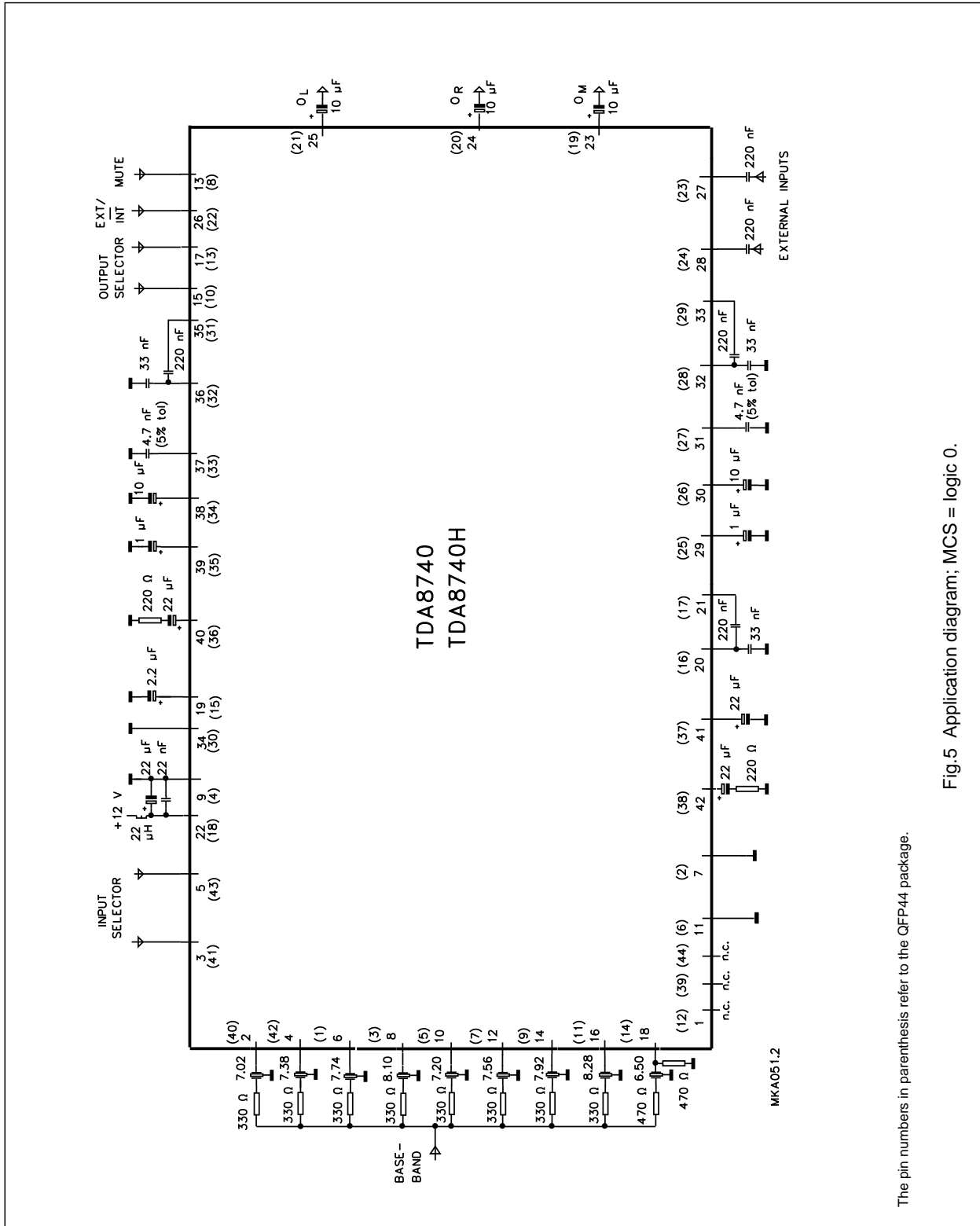

Fig.5 Application diagram; MCS = logic 0.

The pin numbers in parenthesis refer to the QFP44 package.

Satellite sound circuit with noise reduction

TDA8740; TDA8740H

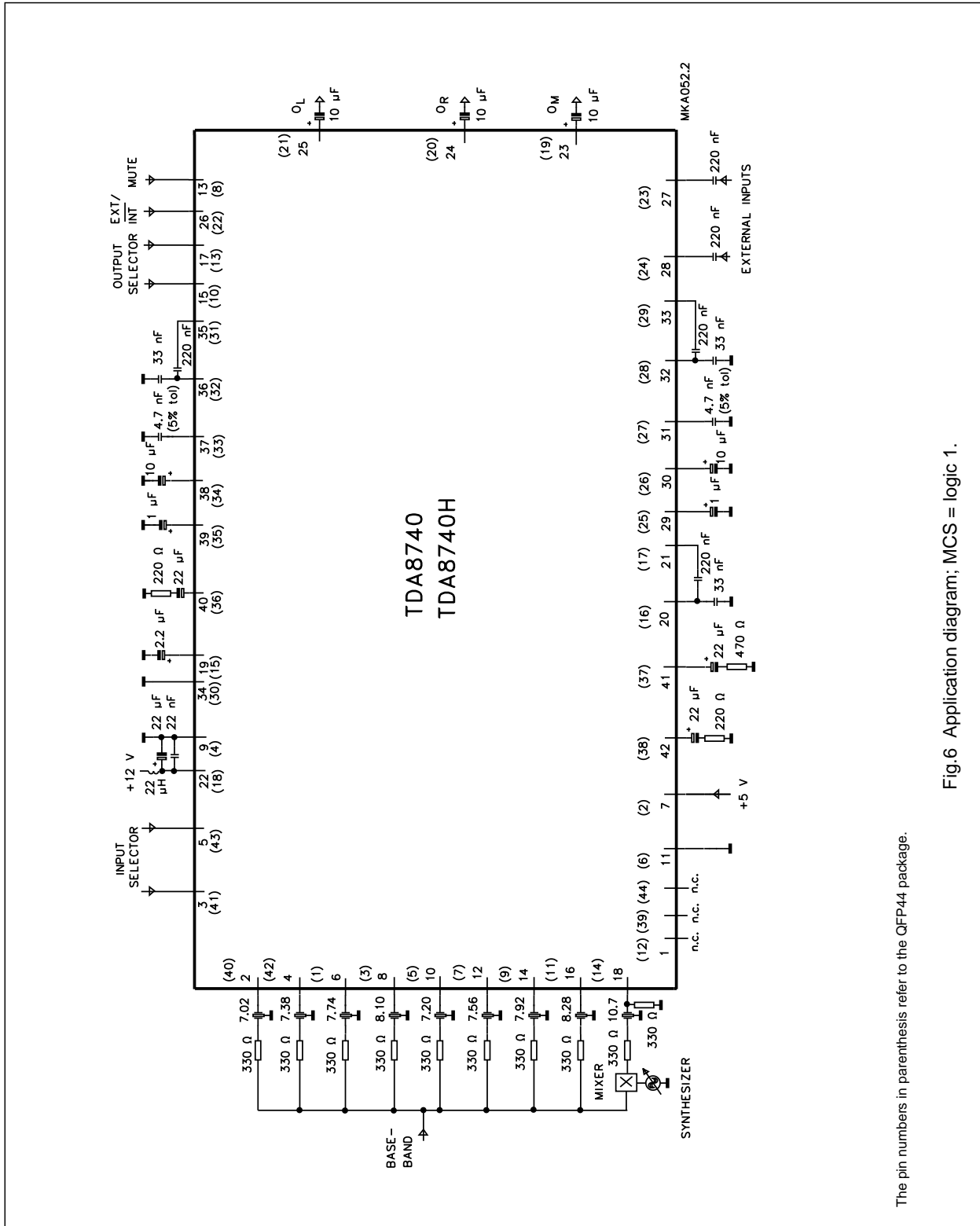

Fig.6 Application diagram; MCS = logic 1.

The pin numbers in parenthesis refer to the QFP44 package.

Satellite sound circuit with noise reduction

TDA8740; TDA8740H

PACKAGE OUTLINES

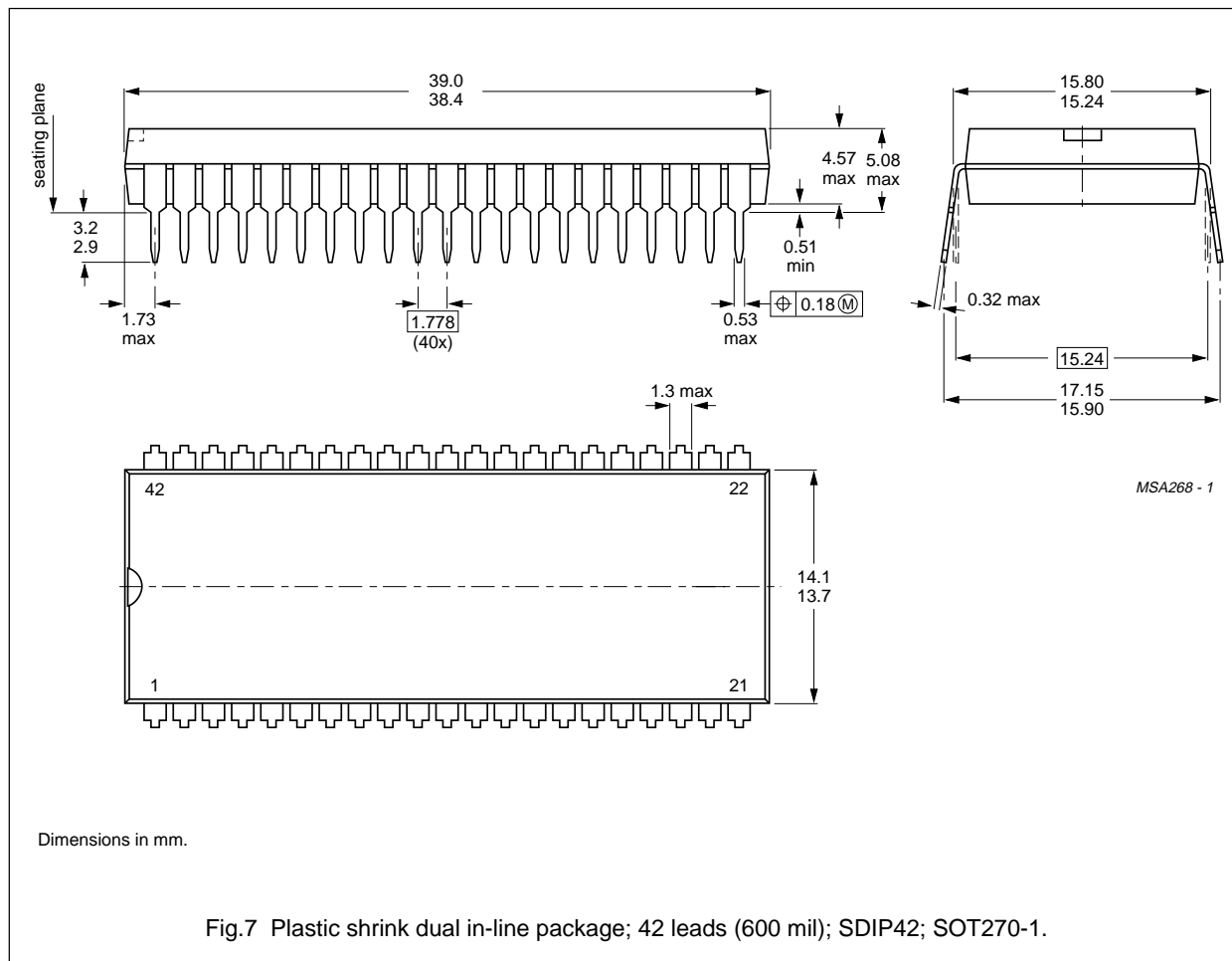
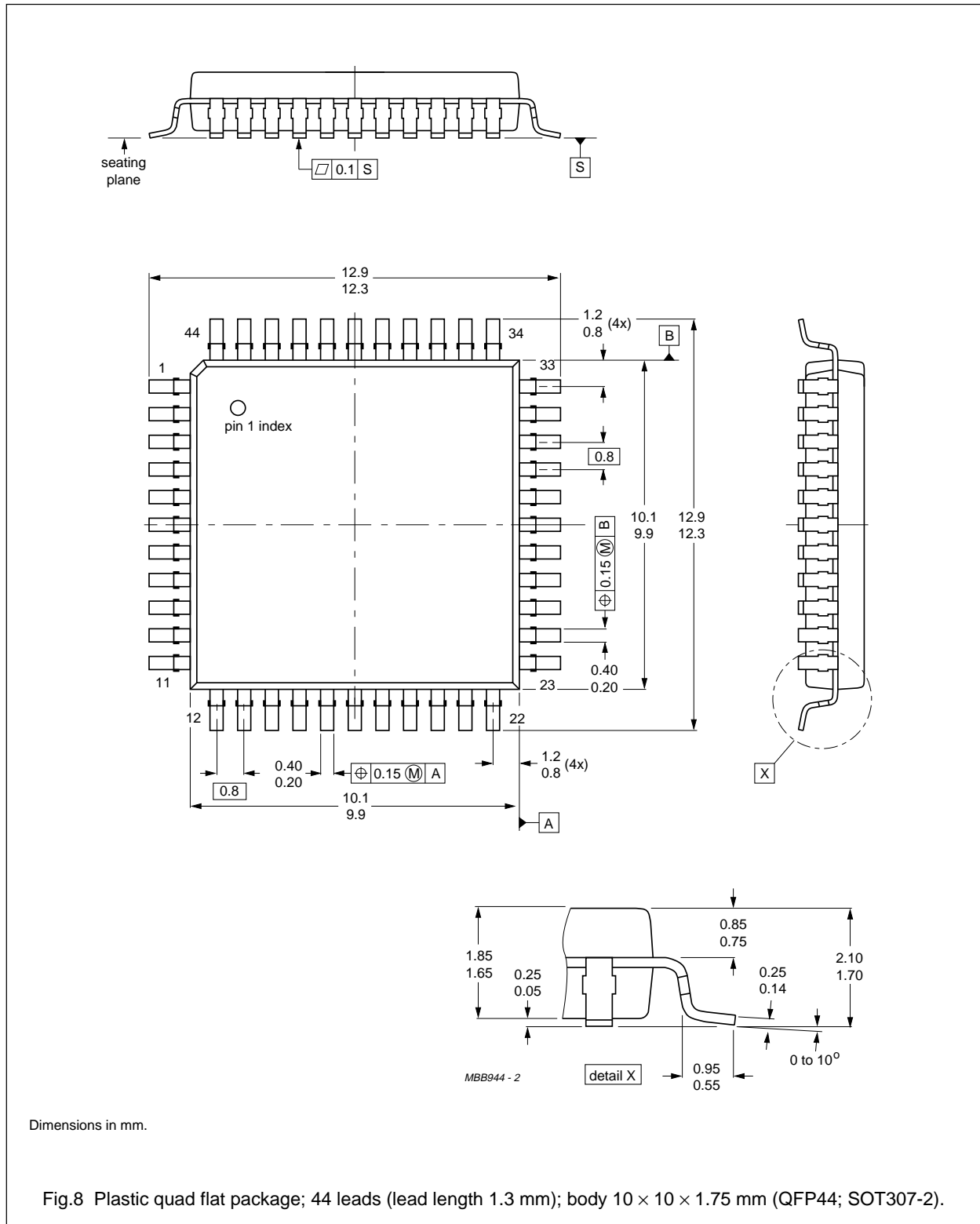

Fig.7 Plastic shrink dual in-line package; 42 leads (600 mil); SDIP42; SOT270-1.

Satellite sound circuit with noise reduction

TDA8740; TDA8740H



---

**Satellite sound circuit with noise reduction****TDA8740; TDA8740H**

---

**SOLDERING****Plastic dual in-line packages**

BY DIP OR WAVE

The maximum permissible temperature of the solder is 260 °C; this temperature must not be in contact with the joint for more than 5 s. The total contact time of successive solder waves must not exceed 5 s.

The device may be mounted up to the seating plane, but the temperature of the plastic body must not exceed the specified storage maximum. If the printed-circuit board has been pre-heated, forced cooling may be necessary immediately after soldering to keep the temperature within the permissible limit.

**REPAIRING SOLDERED JOINTS**

Apply the soldering iron below the seating plane (or not more than 2 mm above it). If its temperature is below 300 °C, it must not be in contact for more than 10 s; if between 300 and 400 °C, for not more than 5 s.

**Quad flat-packs**

BY WAVE

During placement and before soldering, the component must be fixed with a droplet of adhesive. After curing the adhesive, the component can be soldered. The adhesive can be applied by screen printing, pin transfer or syringe dispensing.

Maximum permissible solder temperature is 260° C and maximum duration of package immersion in solder bath is 10 s, if allowed to cool to less than 150 °C within 6 s. Typical dwell time is 4 s at 250 °C.

A modified wave soldering technique is recommended using two solder waves (dual-wave), in which, in a turbulent wave with high-upward pressure is followed by a smooth laminar wave. Using a mildly-activated flux eliminates the need for removal of corrosive residues in most applications.

BY SOLDER PASTE REFLOW

Reflow soldering requires the solder paste (a suspension of fine solder particles, flux and binding agent) to be applied to the substrate by screen printing, stencilling or pressure-syringe dispensing before device placement.

Several techniques exist for reflowing; for example, thermal conduction by heated belt, infrared, and vapour-phase reflow. Dwell times vary between 50 and 300 s according to method. Typical reflow temperatures range from 215 to 250 °C.

Preheating is necessary to dry the paste and evaporate the binding agent. Preheating duration: 45 min. at 45 °C.

**REPAIRING SOLDERED JOINTS (BY HAND-HELD SOLDERING IRON OR PULSE-HEATED SOLDER TOOL)**

Fix the component by first soldering two, diagonally opposite, end pins. Apply the heating tool to the flat part of the pin only. Contact time must be limited to 10 s at up to 300 °C. When using proper tools, all other pins can be soldered in one operation within 2 to 5 s at between 270 and 320 °C. (Pulse-heated soldering is not recommended for SO packages.)

For pulse-heated solder tool (resistance) soldering of VSO packages, solder is applied to the substrate by dipping or by an extra thick tin/lead plating before package placement.

## Satellite sound circuit with noise reduction

TDA8740; TDA8740H

**DEFINITIONS**

<b>Data sheet status</b>	
Objective specification	This data sheet contains target or goal specifications for product development.
Preliminary specification	This data sheet contains preliminary data; supplementary data may be published later.
Product specification	This data sheet contains final product specifications.
<b>Limiting values</b>	
Limiting values given are in accordance with the Absolute Maximum Rating System (IEC 134). Stress above one or more of the limiting values may cause permanent damage to the device. These are stress ratings only and operation of the device at these or at any other conditions above those given in the Characteristics sections of the specification is not implied. Exposure to limiting values for extended periods may affect device reliability.	
<b>Application information</b>	
Where application information is given, it is advisory and does not form part of the specification.	

**LIFE SUPPORT APPLICATIONS**

These products are not designed for use in life support appliances, devices, or systems where malfunction of these products can reasonably be expected to result in personal injury. Philips customers using or selling these products for use in such applications do so at their own risk and agree to fully indemnify Philips for any damages resulting from such improper use or sale.

Satellite sound circuit with noise reduction

TDA8740; TDA8740H

---

**NOTES**

## Philips Semiconductors – a worldwide company

**Argentina:** IEROD, Av. Juramento 1992 - 14.b, (1428)  
BUENOS AIRES, Tel. (541)786 7633, Fax. (541)786 9367

**Australia:** 34 Waterloo Road, NORTH RYDE, NSW 2113,  
Tel. (02)805 4455, Fax. (02)805 4466

**Austria:** Triester Str. 64, A-1101 WIEN, P.O. Box 213,  
Tel. (01)60 101-1236, Fax. (01)60 101-1211

**Belgium:** Postbus 90050, 5600 PB EINDHOVEN, The Netherlands,  
Tel. (31)40 783 749, Fax. (31)40 788 399

**Brazil:** Rua do Rocio 220 - 5<sup>th</sup> floor, Suite 51,  
CEP: 04552-903-SÃO PAULO-SP, Brazil.  
P.O. Box 7383 (01064-970).  
Tel. (011)821-2333, Fax. (011)829-1849

**Canada:** PHILIPS SEMICONDUCTORS/COMPONENTS:  
Tel. (800) 234-7381, Fax. (708) 296-8556

**Chile:** Av. Santa Maria 0760, SANTIAGO,  
Tel. (02)773 816, Fax. (02)777 6730

**Colombia:** IPRELENTO LTDA, Carrera 21 No. 56-17,  
77621 BOGOTÁ, Tel. (571)249 7624/(571)217 4609,  
Fax. (571)217 4549

**Denmark:** Prags Boulevard 80, PB 1919, DK-2300 COPENHAGEN S,  
Tel. (032)88 2636, Fax. (031)57 1949

**Finland:** Sinikalliontie 3, FIN-02630 ESPOO,  
Tel. (9)0-50261, Fax. (9)0-520971

**France:** 4 Rue du Port-aux-Vins, BP317,  
92156 SURESNES Cedex,  
Tel. (01)4099 6161, Fax. (01)4099 6427

**Germany:** P.O. Box 10 63 23, 20043 HAMBURG,  
Tel. (040)3296-0, Fax. (040)3296 213.

**Greece:** No. 15, 25th March Street, GR 17778 TAVROS,  
Tel. (01)4894 339/4894 911, Fax. (01)4814 240

**Hong Kong:** PHILIPS HONG KONG Ltd., 6/F Philips Ind. Bldg.,  
24-28 Kung Yip St., KWAI CHUNG, N.T.,  
Tel. (852)424 5121, Fax. (852)428 6729

**India:** Philips INDIA Ltd, Shivsagar Estate, A Block,  
Dr. Annie Besant Rd. Worli, Bombay 400 018  
Tel. (022)4938 541, Fax. (022)4938 722

**Indonesia:** Philips House, Jalan H.R. Rasuna Said Kav. 3-4,  
P.O. Box 4252, JAKARTA 12950,  
Tel. (021)5201 122, Fax. (021)5205 189

**Ireland:** Newstead, Clonskeagh, DUBLIN 14,  
Tel. (01)640 000, Fax. (01)640 200

**Italy:** PHILIPS SEMICONDUCTORS S.r.l.,  
Piazza IV Novembre 3, 20124 MILANO,  
Tel. (0039)2 6752 2531, Fax. (0039)2 6752 2557

**Japan:** Philips Bldg 13-37, Kohnan2-chome, Minato-ku, TOKYO 108,  
Tel. (03)3740 5028, Fax. (03)3740 0580

**Korea:** (Republic of) Philips House, 260-199 Itaewon-dong,  
Yongsan-ku, SEOUL, Tel. (02)794-5011, Fax. (02)798-8022

**Malaysia:** No. 76 Jalan Universiti, 46200 PETALING JAYA,  
SELANGOR, Tel. (03)750 5214, Fax. (03)757 4880

**Mexico:** 5900 Gateway East, Suite 200, EL PASO, TX 79905,  
Tel. 9-5(800)234-7381, Fax. (708)296-8556

**Netherlands:** Postbus 90050, 5600 PB EINDHOVEN, Bldg. VB  
Tel. (040)783749, Fax. (040)788399

**New Zealand:** 2 Wagener Place, C.P.O. Box 1041, AUCKLAND,  
Tel. (09)849-4160, Fax. (09)849-7811

**Norway:** Box 1, Manglerud 0612, OSLO,  
Tel. (022)74 8000, Fax. (022)74 8341

**Pakistan:** Philips Electrical Industries of Pakistan Ltd.,  
Exchange Bldg. ST-2/A, Block 9, KDA Scheme 5, Clifton,  
KARACHI 75600, Tel. (021)587 4641-49,  
Fax. (021)577035/5874546.

**Philippines:** PHILIPS SEMICONDUCTORS PHILIPPINES Inc,  
106 Valero St. Salcedo Village, P.O. Box 2108 MCC, MAKATI,  
Metro MANILA, Tel. (02)810 0161, Fax. (02)817 3474

**Portugal:** PHILIPS PORTUGUESA, S.A.,  
Rua dr. António Loureiro Borges 5, Arquiparque - Miraflores,  
Apartado 300, 2795 LINDA-A-VELHA,  
Tel. (01)4163160/4163333, Fax. (01)4163174/4163366.

**Singapore:** Lorong 1, Toa Payoh, SINGAPORE 1231,  
Tel. (65)350 2000, Fax. (65)251 6500

**South Africa:** S.A. PHILIPS Pty Ltd.,  
195-215 Main Road Martindale, 2092 JOHANNESBURG,  
P.O. Box 7430 Johannesburg 2000,  
Tel. (011)470-5911, Fax. (011)470-5494.

**Spain:** Balmes 22, 08007 BARCELONA,  
Tel. (03)301 6312, Fax. (03)301 42 43

**Sweden:** Kottbygatan 7, Akalla. S-164 85 STOCKHOLM,  
Tel. (0)8-632 2000, Fax. (0)8-632 2745

**Switzerland:** Allmendstrasse 140, CH-8027 ZÜRICH,  
Tel. (01)488 2211, Fax. (01)481 77 30

**Taiwan:** PHILIPS TAIWAN Ltd., 23-30F, 66, Chung Hsiao West  
Road, Sec. 1. Taipei, Taiwan ROC, P.O. Box 22978,  
TAIPEI 100, Tel. (02)388 7666, Fax. (02)382 4382.

**Thailand:** PHILIPS ELECTRONICS (THAILAND) Ltd.,  
209/2 Sanpavuth-Bangna Road Prakanong,  
Bangkok 10260, THAILAND,  
Tel. (662)398-0141, Fax. (662)398-3319.

**Turkey:** Talatpasa Cad. No. 5, 80640 GÜLTEPE/ISTANBUL,  
Tel. (0212)279 2770, Fax. (0212)269 3094

**United Kingdom:** Philips Semiconductors LTD.,  
276 Bath road, Hayes, MIDDLESEX UB3 5BX,  
Tel. (081)73050000, Fax. (081)7548421

**United States:** 811 East Arques Avenue, SUNNYVALE,  
CA 94088-3409, Tel. (800)234-7381, Fax. (708)296-8556

**Uruguay:** Coronel Mora 433, MONTEVIDEO,  
Tel. (02)70-4044, Fax. (02)92 0601

**For all other countries apply to:** Philips Semiconductors,  
International Marketing and Sales, Building BE-p,  
P.O. Box 218, 5600 MD, EINDHOVEN, The Netherlands,  
Telex 35000 phtncl, Fax. +31-40-724825

SCD35 © Philips Electronics N.V. 1994

All rights are reserved. Reproduction in whole or in part is prohibited without the prior written consent of the copyright owner.

The information presented in this document does not form part of any quotation or contract, is believed to be accurate and reliable and may be changed without notice. No liability will be accepted by the publisher for any consequence of its use. Publication thereof does not convey nor imply any license under patent- or other industrial or intellectual property rights.

Printed in The Netherlands

533061/1500/02/pp24  
Document order number:

Date of release: October 1994  
9397 740 60011

# Philips Semiconductors



# PHILIPS