

ADC08D1020

Low Power, 8-Bit, Dual 1.0 GSPS or Single 2.0 GSPS A/D Converter

General Description

The ADC08D1020 is a dual, low power, high performance, CMOS analog-to-digital converter that builds upon the ADC08D1000 platform. The ADC08D1020 digitizes signals to 8 bits of resolution at sample rates up to 1.3 GSPS. It has expanded features compared to the ADC08D1000, which include a test pattern output for system debug, a clock phase adjust, and selectable output demultiplexer modes. Consuming a typical 1.6 Watts in non-demultiplex mode at 1 GSPS from a single 1.9 Volt supply, this device is guaranteed to have no missing codes over the full operating temperature range. The unique folding and interpolating architecture, the fully differential comparator design, the innovative design of the internal sample-and-hold amplifier and the calibration schemes enable a very flat response of all dynamic parameters beyond Nyquist, producing a high 7.4 Effective Number of Bits (ENOB) with a 498 MHz input signal and a 1 GHz sample rate while providing a 10^{-18} Code Error Rate (C.E.R.) Output formatting is offset binary and the Low Voltage Differential Signaling (LVDS) digital outputs are compatible with IEEE 1596.3-1996, with the exception of an adjustable common mode voltage between 0.8V and 1.2V.

Each converter has a selectable output demultiplexer which feeds two LVDS buses. If the 1:2 demultiplexed mode is selected, the output data rate is reduced to half the input sample rate on each bus. When non-demultiplexed mode is selected, that output data rate on channels DI and DQ are at the same rate as the input sample clock. The two converters can be interleaved and used as a single 2 GSPS ADC.

The converter typically consumes less than 3.5 mW in the Power Down Mode and is available in a leaded or lead-free 128-lead, thermally enhanced, exposed pad, LQFP and operates over the Industrial ($-40^{\circ}\text{C} \leq T_A \leq +85^{\circ}\text{C}$) temperature range.

Features

- Single +1.9V $\pm 0.1\text{V}$ Operation
- Interleave Mode for 2x Sample Rate
- Multiple ADC Synchronization Capability
- Adjustment of Input Full-Scale Range, Offset, and Clock Phase Adjust
- Choice of SDR or DDR output clocking
- 1:1 or 1:2 Selectable Output Demux
- Second DCLK output
- Duty Cycle Corrected Sample Clock
- Test pattern

Key Specifications

- | | |
|--------------------------------------|----------------------|
| ■ Resolution | 8 Bits |
| ■ Max Conversion Rate | 1 GSPS (min) |
| ■ Code Error Rate | 10^{-18} (typ) |
| ■ ENOB @ 498 MHz Input (Normal Mode) | 7.4 Bits (typ) |
| ■ DNL | ± 0.15 LSB (typ) |
| ■ Power Consumption | |
| — Operating in Non-demux Output | 1.6 W (typ) |
| — Operating in 1:2 Demux Output | 1.7 W (typ) |
| — Power Down Mode | 3.5 mW (typ) |

Applications

- Direct RF Down Conversion
- Digital Oscilloscopes
- Satellite Set-top boxes
- Communications Systems
- Test Instrumentation

Ordering Information

Industrial Temperature Range ($-40^{\circ}\text{C} < T_A < +85^{\circ}\text{C}$)	NS Package
ADC08D1020CIYB	Leaded 128-Pin Exposed Pad LQFP
ADC08D1020CIYB/NOPB	Lead-free 128-Pin Exposed Pad LQFP
ADC08D1020DEV	Development Board

Block Diagram

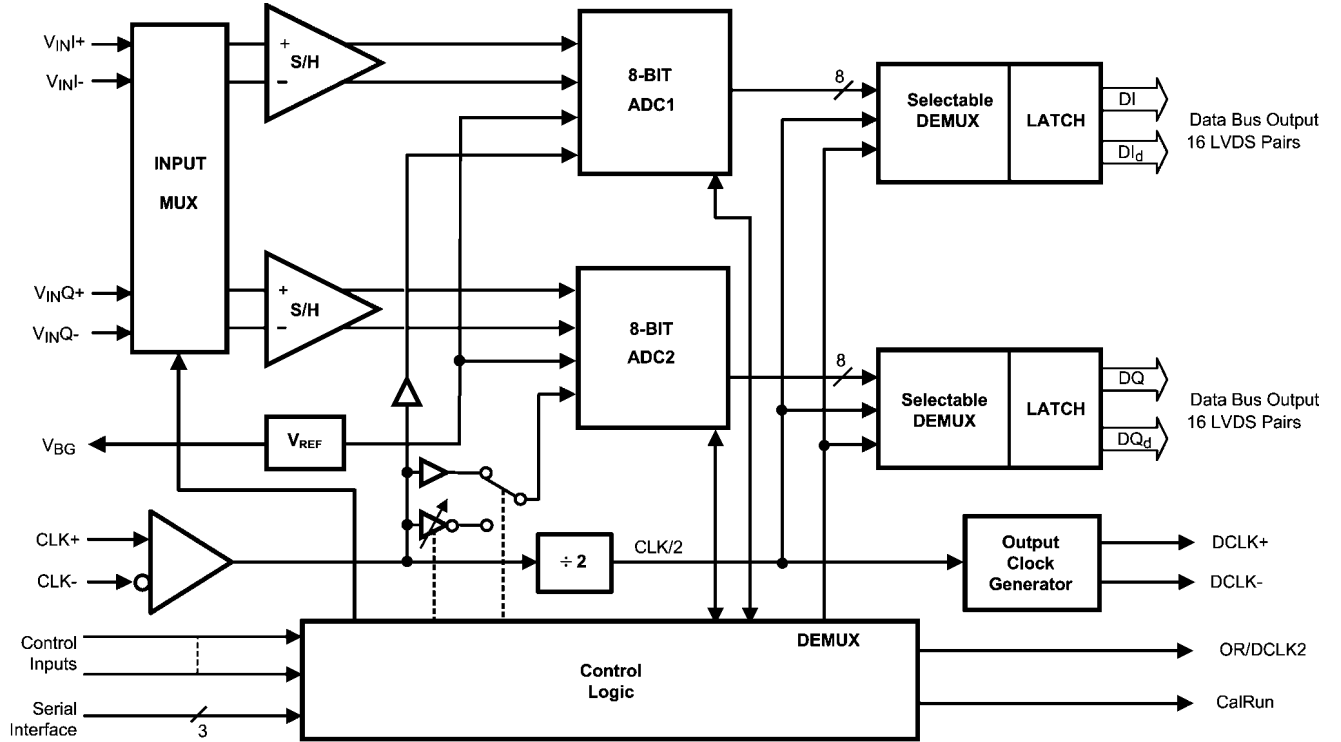

20206253

Pin Configuration

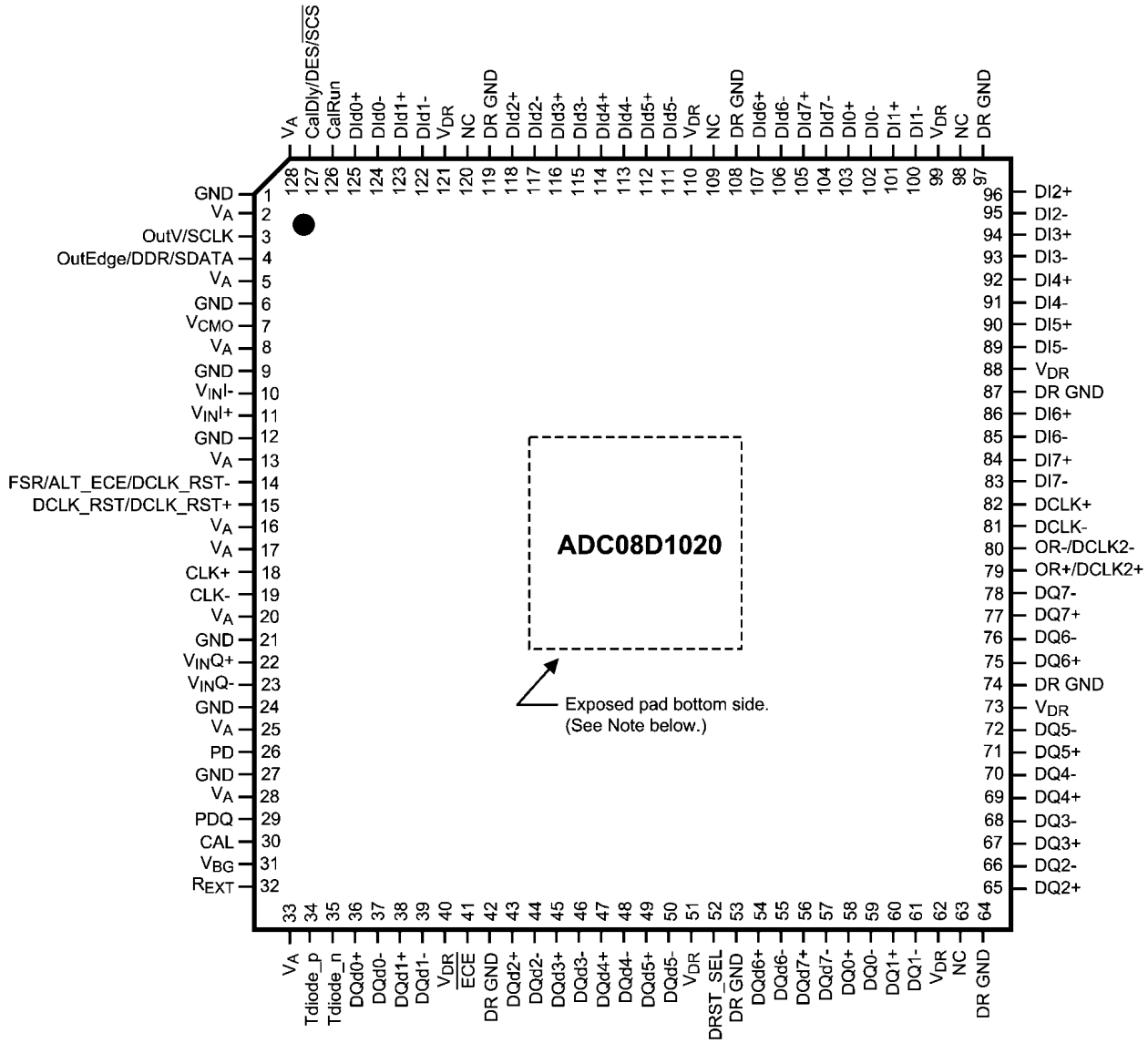

20206201

Note: The exposed pad on the bottom of the package must be soldered to a ground plane to ensure rated performance.

Pin Descriptions and Equivalent Circuits

Pin Functions

Pin No.	Symbol	Equivalent Circuit	Description
3	OutV / SCLK		Output Voltage Amplitude and Serial Interface Clock. Tie this pin high for normal differential DCLK and data amplitude. Ground this pin for a reduced differential output amplitude and reduced power consumption. See 1.1.6 The LVDS Outputs . When the extended control mode is enabled, this pin functions as the SCLK input which clocks in the serial data. See 1.2 NORMAL/EXTENDED CONTROL for details on the extended control mode. See 1.3 THE SERIAL INTERFACE for description of the serial interface.
29	PDQ		Power Down Pins. A logic high on the PD pin puts the entire device into the Power Down Mode.
4	OutEdge / DDR / SDATA		DCLK Edge Select, Double Data Rate Enable and Serial Data Input. This input sets the output edge of DCLK+ at which the output data transitions. (See 1.1.5.2 OutEdge and Demultiplex Control Setting). When this pin is floating or connected to 1/2 the supply voltage, DDR clocking is enabled. When the extended control mode is enabled, this pin functions as the SDATA input. See 1.2 NORMAL/EXTENDED CONTROL for details on the extended control mode. See 1.3 THE SERIAL INTERFACE for description of the serial interface.
15	DCLK_RST / DCLK_RST+		DCLK Reset. When single-ended DCLK_RST is selected by floating or setting pin 52 logic high, a positive pulse on this pin is used to reset and synchronize the DCLK outputs of multiple converters. See 1.5 MULTIPLE ADC SYNCHRONIZATION for detailed description. When differential DCLK_RST is selected by setting pin 52 logic low, this pin receives the positive polarity of a differential pulse signal used to reset and synchronize the DCLK outputs of multiple converters.
26	PD		A logic high on the PDQ pin puts only the "Q" ADC into the Power Down mode.
30	CAL		Calibration Cycle Initiate. A minimum 1280 input clock cycles logic low followed by a minimum of 1280 input clock cycles high on this pin initiates the calibration sequence. See 2.4.2 Calibration for an overview of calibration and 2.4.2.2 On-Command Calibration for a description of on-command calibration.

Pin Functions			
Pin No.	Symbol	Equivalent Circuit	Description
14	FSR/ALT_ECE/ DCLK_RST-		<p>Full Scale Range Select, Alternate Extended Control Enable and DCLK_RST-. This pin has three functions. It can conditionally control the ADC full-scale voltage, enable the extended control mode, or become the negative polarity signal of a differential pair in differential DCLK_RST mode. If pin 52 and pin 41 are floating or at logic high, this pin can be used to set the full-scale-range or can be used as an alternate extended control enable pin. When used as the FSR pin, a logic low on this pin sets the full-scale differential input range to a reduced V_{IN} input level. A logic high on this pin sets the full-scale differential input range to a higher V_{IN} input level. See Converter Electrical Characteristics. To enable the extended control mode, whereby the serial interface and control registers are employed, allow this pin to float or connect it to a voltage equal to $V_A/2$. See 1.2 NORMAL/EXTENDED CONTROL for information on the extended control mode. Note that pin 41 overrides the extended control enable of this pin. When pin 52 is held at logic low, this pin acts as the DCLK_RST- pin. When in differential DCLK_RST mode, there is no pin-controlled FSR and the full-scale-range is defaulted to the higher V_{IN} input level.</p>
127	CalDIly / DES / \overline{SCS}		<p>Calibration Delay, Dual Edge Sampling and Serial Interface Chip Select. With a logic high or low on pin 14, this pin functions as Calibration Delay and sets the number of input clock cycles after power up before calibration begins (See 1.1.1 Calibration). With pin 14 floating, this pin acts as the enable pin for the serial interface input and the CalDIly value becomes "0" (short delay with no provision for a long power-up calibration delay). When this pin is floating or connected to a voltage equal to $V_A/2$, DES (Dual Edge Sampling) mode is selected where the "I" input is sampled at twice the input clock rate and the "Q" input is ignored. See 1.1.5.1 Dual-Edge Sampling.</p>
18 19	CLK+ CLK-		<p>LVDS Clock input pins for the ADC. The differential clock signal must be a.c. coupled to these pins. The input signal is sampled on the falling edge of CLK+. See 1.1.2 Acquiring the Input for a description of acquiring the input and 2.3 THE CLOCK INPUTS for an overview of the clock inputs.</p>
11 10 22 23	$V_{IN}I+$ $V_{IN}I-$ $V_{IN}Q+$ $V_{IN}Q-$		<p>Analog signal inputs to the ADC. The differential full-scale input range of this input is programmable using the FSR pin 14 in normal mode and the Input Full-Scale Voltage Adjust register in the extended control mode. Refer to the V_{IN} specification in the Converter Electrical Characteristics for the full-scale input range in the normal mode. Refer to 1.4 REGISTER DESCRIPTION for the full-scale input range in the extended control mode.</p>

Pin Functions			
Pin No.	Symbol	Equivalent Circuit	Description
7	V_{CMO}		<p>Common Mode Voltage. This pin is the common mode output in d.c. coupling mode and also serves as the a.c. coupling mode select pin. When d.c. coupling is used, the voltage output at this pin is required to be the common mode input voltage at V_{IN+} and V_{IN-} when d.c. coupling is used. This pin should be grounded when a.c. coupling is used at the analog inputs. This pin is capable of sourcing or sinking 100 μA. See 2.2 THE ANALOG INPUT.</p>
31	V_{BG}		<p>Bandgap output voltage capable of 100 μA source/sink and can drive a load up to 80 pF.</p>
126	CalRun		<p>Calibration Running indication. This pin is at a logic high when calibration is running.</p>
32	R_{EXT}		<p>External bias resistor connection. Nominal value is 3.3 kΩ (\pm0.1%) to ground. See 1.1.1 Calibration.</p>
34 35	Tdiode_P Tdiode_N		<p>Temperature Diode Positive (Anode) and Negative (Cathode). These pins may be used for die temperature measurements, however no specified accuracy is implied or guaranteed. Noise coupling from adjacent output data signals has been shown to affect temperature measurements using this feature. See 2.6.2 Thermal Management.</p>
41	\overline{ECE}		<p>Extended Control Enable. This pin always enables and disables Extended Control Enable. When this pin is set logic high, the extended control mode is inactive and all control of the device must be through control pins only. When it is set logic low, the extended control mode is active. This pin overrides the Extended Control Enable signal set using pin 14.</p>
52	DRST_SEL		<p>DCLK_RST select. This pin selects whether the DCLK is reset using a single-ended or differential signal. When this pin is floating or logic high, the DCLK_RST operation is single-ended and pin 14 functions as FSR/ALT_ECE. When this pin is logic low, the DCLK_RST operation becomes differential with functionality on pin 15 (DCLK_RST+) and pin 14 (DCLK_RST-). When in differential DCLK_RST mode, there is no pin-controlled FSR and the full-scale-range is defaulted to the higher V_{IN} input level. When pin 41 is set logic low, the extended control mode is active and the Full-Scale Voltage Adjust registers can be programmed.</p>

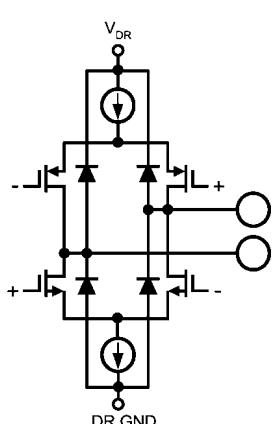
Pin Functions			
Pin No.	Symbol	Equivalent Circuit	Description
83 / 78 84 / 77 85 / 76 86 / 75 89 / 72 90 / 71 91 / 70 92 / 69 93 / 68 94 / 67 95 / 66 96 / 65 100 / 61 101 / 60 102 / 59 103 / 58	DI7- / DQ7- DI7+ / DQ7+ DI6- / DQ6- DI6+ / DQ6+ DI5- / DQ5- DI5+ / DQ5+ DI4- / DQ4- DI4+ / DQ4+ DI3- / DQ3- DI3+ / DQ3+ DI2- / DQ2- DI2+ / DQ2+ DI1- / DQ1- DI1+ / DQ1+ DI0- / DQ0- DI0+ / DQ0+		I and Q channel LVDS Data Outputs that are not delayed in the output demultiplexer. Compared with the DI _d and DQ _d outputs, these outputs represent the later time samples. These outputs should always be terminated with a 100 Ω differential resistor.
104 / 57 105 / 56 106 / 55 107 / 54 111 / 50 112 / 49 113 / 48 114 / 47 115 / 46 116 / 45 117 / 44 118 / 43 122 / 39 123 / 38 124 / 37 125 / 36	DI _d 7- / DQ _d 7- DI _d 7+ / DQ _d 7+ DI _d 6- / DQ _d 6- DI _d 6+ / DQ _d 6+ DI _d 5- / DQ _d 5- DI _d 5+ / DQ _d 5+ DI _d 4- / DQ _d 4- DI _d 4+ / DQ _d 4+ DI _d 3- / DQ _d 3- DI _d 3+ / DQ _d 3+ DI _d 2- / DQ _d 2- DI _d 2+ / DQ _d 2+ DI _d 1- / DQ _d 1- DI _d 1+ / DQ _d 1+ DI _d 0- / DQ _d 0- DI _d 0+ / DQ _d 0+		I and Q channel LVDS Data Outputs that are delayed by one CLK cycle in the output demultiplexer. Compared with the DI/DQ outputs, these outputs represent the earlier time sample. These outputs should be terminated with a 100 Ω differential resistor when enabled. In non-demultiplexed mode, these outputs are disabled and are high impedance when enabled. When disabled, these outputs must be left floating.
79 80	OR+/DCLK2+ OR-/DCLK2-		Out Of Range output. A differential high at these pins indicates that the differential input is out of range (outside the range $\pm V_{IN}/2$ as programmed by the FSR pin in non-extended control mode or the Input Full-Scale Voltage Adjust register setting in the extended control mode). DCLK2 is the exact mirror of DCLK and should output the same signal at the same rate.
82 81	DCLK+ DCLK-		Data Clock. Differential Clock outputs used to latch the output data. Delayed and non-delayed data outputs are supplied synchronous to this signal. In 1:2 demultiplexed mode, this signal is at 1/2 the input clock rate in SDR mode and at 1/4 the input clock rate in the DDR mode. By default, the DCLK outputs are not active during the termination resistor trim section of the calibration cycle. If a system requires DCLK to run continuously during a calibration cycle, the termination resistor trim portion of the cycle can be disabled by setting the Resistor Trim Disable (RTD) bit to logic high in the Extended Configuration Register (address 9h). This disables all subsequent termination resistor trims after the initial trim which occurs during the power on calibration. Therefore, this output is not recommended as a system clock unless the resistor trim is disabled. When the device is in the non-demultiplexed mode, DCLK can only be in DDR mode and the signal is at 1/2 the input clock rate.

Pin Functions			
Pin No.	Symbol	Equivalent Circuit	Description
2, 5, 8, 13, 16, 17, 20, 25, 28, 33, 128	V_A		Analog power supply pins. Bypass these pins to ground.
40, 51, 62, 73, 88, 99, 110, 121	V_{DR}		Output Driver power supply pins. Bypass these pins to DR GND.
1, 6, 9, 12, 21, 24, 27	GND		Ground return for V_A .
42, 53, 64, 74, 87, 97, 108, 119	DR GND		Ground return for V_{DR} .
63, 98, 109, 120	NC		No Connection. Make no connection to these pins.

Absolute Maximum Ratings

(Note 1, Note 2)

If Military/Aerospace specified devices are required, please contact the National Semiconductor Sales Office/ Distributors for availability and specifications.

Supply Voltage (V_A, V_{DR})	2.2V
Supply Difference $V_{DR} - V_A$	0V to 100 mV
Voltage on Any Input Pin (Except V_{IN+}, V_{IN-})	-0.15V to ($V_A + 0.15V$)
Voltage on V_{IN+}, V_{IN-} (Maintaining Common Mode)	-0.15 to 2.5V
Ground Difference IGND - DR GNDI	0V to 100 mV
Input Current at Any Pin (Note 3)	±25 mA
Package Input Current (Note 3)	±50 mA
Power Dissipation at $T_A \leq 85^\circ\text{C}$	2.3 W
ESD Susceptibility (Note 4)	
Human Body Model	2500V
Machine Model	250V
Charged Device Model	1000V
Storage Temperature	-65°C to +150°C

Operating Ratings (Note 1, Note 2)

Ambient Temperature Range	$-40^\circ\text{C} \leq T_A \leq +85^\circ\text{C}$
Supply Voltage (V_A)	+1.8V to +2.0V
Driver Supply Voltage (V_{DR})	+1.8V to V_A
Common Mode Input Voltage	$V_{CMO} \pm 50$ mV
V_{IN+}, V_{IN-} Voltage Range (Maintaining Common Mode)	0V to 2.15V (100% duty cycle) 0V to 2.5V (10% duty cycle)
Ground Difference (IGND - DR GNDI)	0V
CLK Pins Voltage Range	0V to V_A
Differential CLK Amplitude	$0.4V_{P-P}$ to $2.0V_{P-P}$

Package Thermal Resistance

Package	θ_{JA}	θ_{JC} Top of Package	θ_{JC} Thermal Pad
128-Lead, Exposed Pad LQFP	26°C / W	10°C / W	2.8°C / W

Soldering process must comply with National Semiconductor's Reflow Temperature Profile specifications. Refer to www.national.com/packaging. (Note 5)

Converter Electrical Characteristics

The following specifications apply after calibration for $V_A = V_{DR} = 1.9V$; $OutV = 1.9V$; V_{IN} FSR (a.c. coupled) = differential 870 mV_{P-P}; $C_L = 10$ pF; Differential, a.c. coupled Sine Wave Input Clock, $f_{CLK} = 1$ GHz at 0.5 V_{P-P} with 50% duty cycle; $V_{BG} =$ Floating; Non-Extended Control Mode; SDR Mode; $R_{EXT} = 3300 \Omega \pm 0.1\%$; Analog Signal Source Impedance = 100 Ω Differential; 1:2 Output Demultiplex; Duty Cycle Stabilizer on. **Boldface limits apply for $T_A = T_{MIN}$ to T_{MAX} .** All other limits $T_A = 25^\circ\text{C}$, unless otherwise noted. (Note 6, Note 7)

Symbol	Parameter	Conditions	Typical (Note 8)	Limits (Note 8)	Units (Limits)
STATIC CONVERTER CHARACTERISTICS					
INL	Integral Non-Linearity (Best fit)	DC Coupled, 1 MHz Sine Wave Overranged	±0.3	±0.9	LSB (max)
DNL	Differential Non-Linearity	DC Coupled, 1 MHz Sine Wave Overranged	±0.15	±0.6	LSB (max)
	Resolution with No Missing Codes			8	Bits
V_{OFF}	Offset Error		-0.45		LSB (min) LSB (max)
V_{OFF_ADJ}	Input Offset Adjustment Range	Extended Control Mode	±45		mV
PFSE	Positive Full-Scale Error	(Note 9)		±25	mV (max)
NFSE	Negative Full-Scale Error	(Note 9)		±25	mV (max)
FS_ADJ	Full-Scale Adjustment Range	Extended Control Mode	±20	±15	%FS
NORMAL MODE (Non DES) DYNAMIC CONVERTER CHARACTERISTICS, 1:2 DEMUX MODE					
FPBW	Full Power Bandwidth	Normal Mode	2.0		GHz
C.E.R.	Code Error Rate		10^{-18}		Error/Sample
	Gain Flatness	d.c. to 498 MHz d.c. to 1 GHz	±0.8 ±1.0		dBFS dBFS
ENOB	Effective Number of Bits	$f_{IN} = 248$ MHz, $V_{IN} =$ FSR - 0.5 dB $f_{IN} = 498$ MHz, $V_{IN} =$ FSR - 0.5 dB	7.4 7.4	7.0 7.0	Bits (min) Bits (min)
SINAD	Signal-to-Noise Plus Distortion Ratio	$f_{IN} = 248$ MHz, $V_{IN} =$ FSR - 0.5 dB $f_{IN} = 498$ MHz, $V_{IN} =$ FSR - 0.5 dB	46.5 46.5	43.9 43.9	dB (min) dB (min)

Symbol	Parameter	Conditions	Typical (Note 8)	Limits (Note 8)	Units (Limits)
SNR	Signal-to-Noise Ratio	$f_{IN} = 248 \text{ MHz}, V_{IN} = \text{FSR} - 0.5 \text{ dB}$	46.8	45.1	dB (min)
		$f_{IN} = 498 \text{ MHz}, V_{IN} = \text{FSR} - 0.5 \text{ dB}$	46.8	45.1	dB (min)
THD	Total Harmonic Distortion	$f_{IN} = 248 \text{ MHz}, V_{IN} = \text{FSR} - 0.5 \text{ dB}$	-58	-50	dB (max)
		$f_{IN} = 498 \text{ MHz}, V_{IN} = \text{FSR} - 0.5 \text{ dB}$	-58	-50	dB (max)
2nd Harm	Second Harmonic Distortion	$f_{IN} = 248 \text{ MHz}, V_{IN} = \text{FSR} - 0.5 \text{ dB}$	-63		dB
		$f_{IN} = 498 \text{ MHz}, V_{IN} = \text{FSR} - 0.5 \text{ dB}$	-63		dB
3rd Harm	Third Harmonic Distortion	$f_{IN} = 248 \text{ MHz}, V_{IN} = \text{FSR} - 0.5 \text{ dB}$	-65		dB
		$f_{IN} = 498 \text{ MHz}, V_{IN} = \text{FSR} - 0.5 \text{ dB}$	-65		dB
SFDR	Spurious-Free dynamic Range	$f_{IN} = 248 \text{ MHz}, V_{IN} = \text{FSR} - 0.5 \text{ dB}$	58	50	dB (min)
		$f_{IN} = 498 \text{ MHz}, V_{IN} = \text{FSR} - 0.5 \text{ dB}$	58	50	dB (min)
IMD	Intermodulation Distortion	$f_{IN1} = 250 \text{ MHz}, V_{IN} = \text{FSR} - 7 \text{ dB}$ $f_{IN2} = 260 \text{ MHz}, V_{IN} = \text{FSR} - 7 \text{ dB}$	-50		dB
	Out of Range Output Code (In addition to OR Output high)	$(V_{IN+}) - (V_{IN-}) > + \text{ Full Scale}$		255	
		$(V_{IN+}) - (V_{IN-}) < - \text{ Full Scale}$		0	
NORMAL MODE (Non DES) DYNAMIC CONVERTER CHARACTERISTICS, 1:1 DEMUX MODE					
ENOB	Effective Number of Bits	$f_{IN} = 248 \text{ MHz}, V_{IN} = \text{FSR} - 0.5 \text{ dB}$	7.3		Bits
		$f_{IN} = 498 \text{ MHz}, V_{IN} = \text{FSR} - 0.5 \text{ dB}$	7.3		Bits
SINAD	Signal-to-Noise Plus Distortion Ratio	$f_{IN} = 248 \text{ MHz}, V_{IN} = \text{FSR} - 0.5 \text{ dB}$	45.7		dB
		$f_{IN} = 498 \text{ MHz}, V_{IN} = \text{FSR} - 0.5 \text{ dB}$	45.7		dB
SNR	Signal-to-Noise Ratio	$f_{IN} = 248 \text{ MHz}, V_{IN} = \text{FSR} - 0.5 \text{ dB}$	46		dB
		$f_{IN} = 498 \text{ MHz}, V_{IN} = \text{FSR} - 0.5 \text{ dB}$	46		dB
THD	Total Harmonic Distortion	$f_{IN} = 248 \text{ MHz}, V_{IN} = \text{FSR} - 0.5 \text{ dB}$	-57		dB
		$f_{IN} = 498 \text{ MHz}, V_{IN} = \text{FSR} - 0.5 \text{ dB}$	-57		dB
2nd Harm	Second Harmonic Distortion	$f_{IN} = 248 \text{ MHz}, V_{IN} = \text{FSR} - 0.5 \text{ dB}$	-63		dB
		$f_{IN} = 498 \text{ MHz}, V_{IN} = \text{FSR} - 0.5 \text{ dB}$	-63		dB
3rd Harm	Third Harmonic Distortion	$f_{IN} = 248 \text{ MHz}, V_{IN} = \text{FSR} - 0.5 \text{ dB}$	-64		dB
		$f_{IN} = 498 \text{ MHz}, V_{IN} = \text{FSR} - 0.5 \text{ dB}$	-64		dB
SFDR	Spurious-Free dynamic Range	$f_{IN} = 248 \text{ MHz}, V_{IN} = \text{FSR} - 0.5 \text{ dB}$	57		dB
		$f_{IN} = 498 \text{ MHz}, V_{IN} = \text{FSR} - 0.5 \text{ dB}$	57		dB
INTERLEAVE MODE (DES Pin 127=Float) - DYNAMIC CONVERTER CHARACTERISTICS, 1:4 DEMUX MODE					
FPBW	Full Power Bandwidth	Dual Edge Sampling Mode	1.3		GHz
ENOB	Effective Number of Bits	$f_{IN} = 498 \text{ MHz}, V_{IN} = \text{FSR} - 0.5 \text{ dB}$	7.3	6.7	Bits (min)
SINAD	Signal to Noise Plus Distortion Ratio	$f_{IN} = 498 \text{ MHz}, V_{IN} = \text{FSR} - 0.5 \text{ dB}$	46	42.1	dB
SNR	Signal to Noise Ratio	$f_{IN} = 498 \text{ MHz}, V_{IN} = \text{FSR} - 0.5 \text{ dB}$	46.3	43.8	dB (min)
THD	Total Harmonic Distortion	$f_{IN} = 498 \text{ MHz}, V_{IN} = \text{FSR} - 0.5 \text{ dB}$	-58	-47	dB (max)
2nd Harm	Second Harmonic Distortion	$f_{IN} = 498 \text{ MHz}, V_{IN} = \text{FSR} - 0.5 \text{ dB}$	-58		dB
3rd Harm	Third Harmonic Distortion	$f_{IN} = 498 \text{ MHz}, V_{IN} = \text{FSR} - 0.5 \text{ dB}$	-66		dB
SFDR	Spurious Free Dynamic Range	$f_{IN} = 498 \text{ MHz}, V_{IN} = \text{FSR} - 0.5 \text{ dB}$	57	47	dB (min)
ANALOG INPUT AND REFERENCE CHARACTERISTICS					
V_{IN}	Full Scale Analog Differential Input Range	FSR pin 14 Low	650	580	mV _{P-P} (min)
				720	mV _{P-P} (max)
		FSR pin 14 High	870	800	mV _{P-P} (min)
				940	mV _{P-P} (max)
V_{CMI}	Common Mode Input Voltage		V_{CMI}	$V_{CMI} - 0.05$	V (min)
				$V_{CMI} + 0.05$	V (max)

Symbol	Parameter	Conditions	Typical (Note 8)	Limits (Note 8)	Units (Limits)
C_{IN}	Analog Input Capacitance, Normal operation (Note 10, Note 11)	Differential	0.02		pF
		Each input pin to ground	1.6		pF
	Analog Input Capacitance, DES Mode (Note 10, Note 11)	Differential	0.08		pF
		Each input pin to ground	2.2		pF
R_{IN}	Differential Input Resistance		100		Ω (min)
					Ω (max)
ANALOG OUTPUT CHARACTERISTICS					
V_{CMO}	Common Mode Output Voltage	$I_{CMO} = \pm 100 \mu A$	1.26	0.95	V (min)
				1.45	V (max)
TC V_{CMO}	Common Mode Output Voltage Temperature Coefficient	$T_A = -40^\circ C$ to $+85^\circ C$	118		ppm/ $^\circ C$
V_{CMO_LVL}	V_{CMO} input threshold to set DC Coupling mode	$V_A = 1.8V$	0.60		V
		$V_A = 2.0V$	0.66		V
$C_{LOAD} V_{CMO}$	Maximum V_{CMO} load Capacitance			80	pF
V_{BG}	Bandgap Reference Output Voltage	$I_{BG} = \pm 100 \mu A$	1.26	1.20	V (min)
				1.33	V (max)
TC V_{BG}	Bandgap Reference Voltage Temperature Coefficient	$T_A = -40^\circ C$ to $+85^\circ C$, $I_{BG} = \pm 100 \mu A$	28		ppm/ $^\circ C$
$C_{LOAD} V_{BG}$	Maximum Bandgap Reference load Capacitance			80	pF
CHANNEL-TO-CHANNEL CHARACTERISTICS					
	Offset Match		1		LSB
	Positive Full-Scale Match	Zero offset selected in Control Register	1		LSB
	Negative Full-Scale Match	Zero offset selected in Control Register	1		LSB
	Phase Matching (I, Q)	$f_{IN} = 1.0$ GHz	< 1		Degree
X-TALK	Crosstalk from I (Aggressor) to Q (Victim) Channel	Aggressor = 867 MHz F.S. Victim = 100 MHz F.S.	-65		dB
X-TALK	Crosstalk from Q (Aggressor) to I (Victim) Channel	Aggressor = 867 MHz F.S. Victim = 100 MHz F.S.	-65		dB
LVDS CLK Input Characteristics (Typical specs also apply to DCLK_RST)					
V_{ID}	Differential Clock Input Level	Sine Wave Clock	0.6	0.4	V_{P-P} (min)
				2.0	V_{P-P} (max)
		Square Wave Clock	0.6	0.4	V_{P-P} (min)
				2.0	V_{P-P} (max)
V_{OSI}	Input Offset Voltage		1.2		V
C_{IN}	Input Capacitance (Note 10, Note 11)	Differential	0.02		pF
		Each input to ground	1.5		pF
DIGITAL CONTROL PIN CHARACTERISTICS					
V_{IH}	Logic High Input Voltage	OutV, DCLK_RST, PD, PDQ, CAL		$0.69 \times V_A$	V (min)
		OutEdge, FSR, CalDly		$0.79 \times V_A$	
V_{IL}	Logic Low Input Voltage	OutV, DCLK_RST, PD, PDQ, CAL		$0.28 \times V_A$	V (max)
		OutEdge, FSR, CalDly		$0.21 \times V_A$	
C_{IN}	Input Capacitance (Note 11, Note 13)	Each input to ground	1.2		pF

Symbol	Parameter	Conditions	Typical (Note 8)	Limits (Note 8)	Units (Limits)
DIGITAL OUTPUT CHARACTERISTICS					
V_{OD}	LVDS Differential Output Voltage	Measured differentially, $OutV = V_A$, $V_{BG} = \text{Floating}$ (Note 15)	740	480	mV _{P-P} (min)
				950	mV _{P-P} (max)
		Measured differentially, $OutV = GND$, $V_{BG} = \text{Floating}$ (Note 15)	560	320	mV _{P-P} (min)
				720	mV _{P-P} (max)
$\Delta V_{O\text{ DIFF}}$	Change in LVDS Output Swing Between Logic Levels		± 1		mV
V_{OS}	Output Offset Voltage See Figure 1	$V_{BG} = \text{Floating}$	800		mV
V_{OS}	Output Offset Voltage See Figure 1	$V_{BG} = V_A$ (Note 15)	1175		mV
ΔV_{OS}	Output Offset Voltage Change Between Logic Levels		± 1		mV
I_{OS}	Output Short Circuit Current	Output+ & Output– connected to 0.8V	± 4		mA
Z_O	Differential Output Impedance		100		Ω
V_{OH}	CalRun H level output	$I_{OH} = -400 \mu A$ (Note 12)	1.65	1.5	V
V_{OL}	CalRun L level output	$I_{OH} = 400 \mu A$ (Note 12)	0.15	0.3	V
POWER SUPPLY CHARACTERISTICS					
I_A	Analog Supply Current	1:2 Demux Output			
		PD = PDQ = Low	697	788	mA (max)
		PD = Low, PDQ = High	460	523	mA (max)
		PD = PDQ = High	1.7		mA
I_{DR}	Output Driver Supply Current	Non-demux Output			
		PD = PDQ = Low	712	803	mA (max)
		PD = Low, PDQ = High	464	530	mA (max)
		PD = PDQ = High	1.5		mA
P_D	Power Consumption	1:2 Demux Output			
		PD = PDQ = Low	212	300	mA (max)
		PD = Low, PDQ = High	117	161	mA (max)
		PD = PDQ = High	0.054		mA
$PSRR1$	D.C. Power Supply Rejection Ratio	Non-demux Output			
		PD = PDQ = Low	136	212	mA (max)
		PD = Low, PDQ = High	83.5	120	mA (max)
		PD = PDQ = High	0.047		mA
P_D	Power Consumption	1:2 Demux Output			
		PD = PDQ = Low	1.7	2.06	W (max)
		PD = Low, PDQ = High	1.0	1.3	W (max)
		PD = PDQ = High	3.3		mW
P_D	Power Consumption	Non-demux Output			
		PD = PDQ = Low	1.6	1.92	W (max)
		PD = Low, PDQ = High	1.04	1.235	W (max)
		PD = PDQ = High	2.76		mW
$PSRR1$	D.C. Power Supply Rejection Ratio	Change in Full Scale Error with change in V_A from 1.8V to 2.0V	30		dB

Symbol	Parameter	Conditions	Typical (Note 8)	Limits (Note 8)	Units (Limits)	
AC ELECTRICAL CHARACTERISTICS						
$f_{CLK(max)}$	Maximum Input Clock Frequency	Normal Mode (non DES) or DES Mode in 1:2 Demux Output	1.3	1.0	GHz (min)	
		Normal Mode (non DES) or DES Mode in Non-demux Output		1.0	GHz (max)	
$f_{CLK(min)}$	Minimum Input Clock Frequency	Normal Mode (non DES)	200		MHz	
		DES Mode	500		MHz	
	Input Clock Duty Cycle	$200\text{ MHz} \leq f_{CLK} \leq 1\text{ GHz}$ (Normal Mode) (Note 12)	50	20	% (min)	
				80	% (max)	
		$500\text{ MHz} \leq f_{CLK} \leq 1\text{ GHz}$ (DES Mode) (Note 12)	50	20	% (min)	
				80	% (max)	
t_{CL}	Input Clock Low Time	(Note 11)	500	200	ps (min)	
t_{CH}	Input Clock High Time	(Note 11)	500	200	ps (min)	
	DCLK Duty Cycle	(Note 11)	50	45	% (min)	
				55	% (max)	
t_{SR}	Setup Time DCLK_RST±	(Note 12) Differential DCLK_RST	90		ps	
t_{HR}	Hold Time DCLK_RST±	(Note 12) Differential DCLK_RST	30		ps	
t_{PWR}	Pulse Width DCLK_RST±	(Note 11)		4	CLK± Cycles (min)	
t_{LHT}	Differential Low-to-High Transition Time	10% to 90%, $C_L = 2.5\text{ pF}$	150		ps	
t_{HLT}	Differential High-to-Low Transition Time	10% to 90%, $C_L = 2.5\text{ pF}$	150		ps	
t_{OSK}	DCLK-to-Data Output Skew	50% of DCLK transition to 50% of Data transition, SDR Mode and DDR Mode, 0° DCLK (Note 11)	±50		ps (max)	
t_{SU}	Data-to-DCLK Set-Up Time	DDR Mode, 90° DCLK (Note 11)	750		ps	
t_H	DCLK-to-Data Hold Time	DDR Mode, 90° DCLK (Note 11)	890		ps	
t_{AD}	Sampling (Aperture) Delay	Input CLK+ Fall to Acquisition of Data	1.6		ns	
t_{AJ}	Aperture Jitter		0.4		ps (rms)	
t_{OD}	Input Clock-to Data Output Delay (in addition to Pipeline Delay)	50% of Input Clock transition to 50% of Data transition	4.0		ns	
	Pipeline Delay (Latency) in 1:2 Demux Mode (Note 11, Note 14)	DI Outputs			13	Input Clock Cycles
		DI _d Outputs			14	
		DQ Outputs	Normal Mode		13	
			DES Mode		13.5	
		DQ _d Outputs	Normal Mode		14	
			DES Mode		14.5	
	Pipeline Delay (Latency) in Non-Demux Mode (Note 11, Note 14)	DI Outputs			13	Input Clock Cycles
		DQ Outputs	Normal Mode		13	
			DES Mode		13.5	
	Over Range Recovery Time	Differential V_{IN} step from ±1.2V to 0V to get accurate conversion	1		Input Clock Cycle	
t_{WU}	PD low to Rated Accuracy Conversion (Wake-Up Time)	Normal Mode (Note 11)	500		ns	
		DES Mode (Note 11)	1		µs	
f_{SCLK}	Serial Clock Frequency	(Note 11)	15		MHz	
t_{SSU}	Serial Data to Serial Clock Rising Setup Time	(Note 11)	2.5		ns (min)	

Symbol	Parameter	Conditions	Typical (Note 8)	Limits (Note 8)	Units (Limits)
t_{SH}	Serial Data to Serial Clock Rising Hold Time	(Note 11)	1		ns (min)
t_{SCS}	\overline{CS} to Serial Clock Rising Setup Time		2.5		ns
t_{HCS}	\overline{CS} to Serial Clock Falling Hold Time		1.5		ns
	Serial Clock Low Time			26	ns (min)
	Serial Clock High Time			26	ns (min)
t_{CAL}	Calibration Cycle Time		1.4×10^6		Clock Cycles
t_{CAL_L}	CAL Pin Low Time	See Figure 10 (Note 11)		1280	Clock Cycles (min)
t_{CAL_H}	CAL Pin High Time	See Figure 10 (Note 11)		1280	Clock Cycles (min)
t_{CalDly}	Calibration delay determined by pin 127	CalDly = Low See 1.1.1 Calibration, Figure 10, (Note 11)		2^{26}	Clock Cycles (max)
		CalDly = High See 1.1.1 Calibration, Figure 10, (Note 11)		2^{32}	Clock Cycles (max)

Note 1: Absolute Maximum Ratings indicate limits beyond which damage to the device may occur. There is no guarantee of operation at the Absolute Maximum Ratings. Operating Ratings indicate conditions for which the device is functional, but do not guarantee specific performance limits. For guaranteed specifications and test conditions, see the Electrical Characteristics. The guaranteed specifications apply only for the test conditions listed. Some performance characteristics may degrade when the device is not operated under the listed test conditions.

Note 2: All voltages are measured with respect to GND = DR GND = 0V, unless otherwise specified.

Note 3: When the input voltage at any pin exceeds the power supply limits (that is, less than GND or greater than V_A), the current at that pin should be limited to 25 mA. The 50 mA maximum package input current rating limits the number of pins that can safely exceed the power supplies with an input current of 25 mA to two. This limit is not placed upon the power, ground and digital output pins.

Note 4: Human body model is 100 pF capacitor discharged through a 1.5 k Ω resistor. Machine model is 220 pF discharged through ZERO Ohms. Charged device model simulates a pin slowly acquiring charge (such as from a device sliding down the feeder in an automated assembler) then rapidly being discharged.

Note 5: Reflow temperature profiles are different for lead-free and non-lead-free packages.

Note 6: The analog inputs are protected as shown below. Input voltage magnitudes beyond the Absolute Maximum Ratings may damage this device.

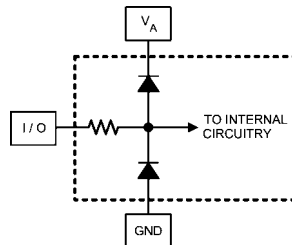

20206204

Note 7: To guarantee accuracy, it is required that V_A and V_{DR} be well bypassed. Each supply pin must be decoupled with separate bypass capacitors. Additionally, achieving rated performance requires that the backside exposed pad be well grounded.

Note 8: Typical figures are at $T_A = 25^\circ\text{C}$, and represent most likely parametric norms. Test limits are guaranteed to National's AOQL (Average Outgoing Quality Level).

Note 9: Calculation of Full-Scale Error for this device assumes that the actual reference voltage is exactly its nominal value. Full-Scale Error for this device, therefore, is a combination of Full-Scale Error and Reference Voltage Error. See Figure 2. For relationship between Gain Error and Full-Scale Error, see Specification Definitions for Gain Error.

Note 10: The analog and clock input capacitances are die capacitances only. Additional package capacitances of 0.65 pF differential and 0.95 pF each pin to ground are isolated from the die capacitances by lead and bond wire inductances.

Note 11: This parameter is guaranteed by design and is not tested in production.

Note 12: This parameter is guaranteed by design and/or characterization and is not tested in production.

Note 13: The digital control pin capacitances are die capacitances only. Additional package capacitance of 1.6 pF each pin to ground are isolated from the die capacitances by lead and bond wire inductances.

Note 14: Each of the two converters of the ADC08D1020 has two LVDS output buses, which each clock data out at one half the sample rate. The data at each bus is clocked out at one half the sample rate. The second bus (D0 through D7) has a pipeline latency that is one Input Clock cycle less than the latency of the first bus (Dd0 through Dd7) in 1:2 demux mode.

Note 15: Tying V_{BG} to the supply rail will increase the output offset voltage (V_{OS}) by 400 mV (typical), as shown in the V_{OS} specification above. Tying V_{BG} to the supply rail will also affect the differential LVDS output voltage (V_{OD}), causing it to increase by 40 mV (typical).

Specification Definitions

APERTURE (SAMPLING) DELAY is the amount of delay, measured from the sampling edge of the Clock input, after which the signal present at the input pin is sampled inside the device.

APERTURE JITTER (t_{AJ}) is the variation in aperture delay from sample to sample. Aperture jitter shows up as input noise.

CODE ERROR RATE (C.E.R.) is the probability of error and is defined as the probable number of word errors on the ADC output per unit of time divided by the number of words seen in that amount of time. A C.E.R. of 10^{-18} corresponds to a statistical error in one word about every four (4) years.

CLOCK DUTY CYCLE is the ratio of the time that the clock waveform is at a logic high to the total time of one clock period.

DIFFERENTIAL NON-LINEARITY (DNL) is the measure of the maximum deviation from the ideal step size of 1 LSB. Measured at sample rate = 500 MSPS with a 1MHz input sine wave.

EFFECTIVE NUMBER OF BITS (ENOB, or EFFECTIVE BITS) is another method of specifying Signal-to-Noise and Distortion Ratio, or SINAD. ENOB is defined as $(\text{SINAD} - 1.76) / 6.02$ and says that the converter is equivalent to a perfect ADC of this (ENOB) number of bits.

FULL POWER BANDWIDTH (FPBW) is a measure of the frequency at which the reconstructed output fundamental drops 3 dB below its low frequency value for a full-scale input.

GAIN ERROR is the deviation from the ideal slope of the transfer function. It can be calculated from Offset and Full-Scale Errors:

Positive Gain Error = Offset Error – Positive Full-Scale Error

Negative Gain Error = –(Offset Error – Negative Full-Scale Error)

Gain Error = Negative Full-Scale Error – Positive Full-Scale Error = Positive Gain Error + Negative Gain Error

INTEGRAL NON-LINEARITY (INL) is a measure of worst case deviation of the ADC transfer function from an ideal straight line drawn through the ADC transfer function. The deviation of any given code from this straight line is measured from the center of that code value step. The best fit method is used

INTERMODULATION DISTORTION (IMD) is the creation of additional spectral components as a result of two sinusoidal frequencies being applied to the ADC input at the same time. It is defined as the ratio of the power in the second and third order intermodulation products to the power in one of the original frequencies. IMD is usually expressed in dBFS.

LSB (LEAST SIGNIFICANT BIT) is the bit that has the smallest value or weight of all bits. This value is

$$V_{FS} / 2^N$$

where V_{FS} is the differential full-scale amplitude V_{IN} as set by the FSR input and "n" is the ADC resolution in bits, and which is 8 for the ADC08D1020.

LOW VOLTAGE DIFFERENTIAL SIGNALING (LVDS) DIFFERENTIAL VOLTAGE (V_{ID} and V_{OD}) is two times the absolute value of the difference between the V_{D+} and V_{D-} signals; each measured with respect to Ground.

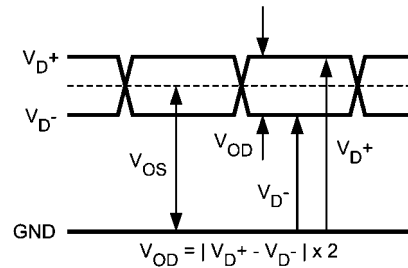

20206246

FIGURE 1.

LVDS OUTPUT OFFSET VOLTAGE (V_{OS}) is the midpoint between the D+ and D– pins output voltage with respect to ground, i.e., $[(V_{D+}) + (V_{D-})] / 2$.

MISSING CODES are those output codes that are skipped and will never appear at the ADC outputs. These codes cannot be reached with any input value.

MSB (MOST SIGNIFICANT BIT) is the bit that has the largest value or weight. Its value is one half of full scale.

NEGATIVE FULL-SCALE ERROR (NFSE) is a measure of how far the first code transition is from the ideal $1/2$ LSB above a differential $-V_{IN}/2$. For the ADC08D1020 the reference voltage is assumed to be ideal, so this error is a combination of full-scale error and reference voltage error.

OFFSET ERROR (V_{OFF}) is a measure of how far the mid-scale point is from the ideal zero voltage differential input.

Offset Error = Actual Input causing average of 8k samples to result in an average code of 127.5.

OUTPUT DELAY (t_{OD}) is the time delay (in addition to Pipeline Delay) after the falling edge of CLK+ before the data update is present at the output pins.

OVER-RANGE RECOVERY TIME is the time required after the differential input voltages goes from $\pm 1.2V$ to $0V$ for the converter to recover and make a conversion with its rated accuracy.

PIPELINE DELAY (LATENCY) is the number of input clock cycles between initiation of conversion and when that data is presented to the output driver stage. New data is available at every clock cycle, but the data lags the conversion by the Pipeline Delay plus the t_{OD} .

POSITIVE FULL-SCALE ERROR (PFSE) is a measure of how far the last code transition is from the ideal $1-1/2$ LSB below a differential $+V_{IN}/2$. For the ADC08D1020 the reference voltage is assumed to be ideal, so this error is a combination of full-scale error and reference voltage error.

POWER SUPPLY REJECTION RATIO (PSRR) can be one of two specifications. PSRR1 (DC PSRR) is the ratio of the change in full-scale error that results from a power supply voltage change from 1.8V to 2.0V. PSRR2 (AC PSRR) is a measure of how well an a.c. signal injected on the power supply is rejected from the output and is measured with a 248 MHz, 50 mV_{P-P} signal riding upon the power supply. It is the ratio of the output amplitude of that signal at the output to its amplitude on the power supply pin. PSRR is expressed in dB.

SIGNAL TO NOISE RATIO (SNR) is the ratio, expressed in dB, of the rms value of the input signal at the output to the rms value of the sum of all other spectral components below one-half the sampling frequency, not including harmonics or d.c.

SIGNAL TO NOISE PLUS DISTORTION (S/(N+D) or SINAD) is the ratio, expressed in dB, of the rms value of the input signal at the output to the rms value of all of the other

spectral components below half the input clock frequency, including harmonics but excluding d.c.

SPURIOUS-FREE DYNAMIC RANGE (SFDR) is the difference, expressed in dB, between the rms values of the input signal at the output and the peak spurious signal, where a spurious signal is any signal present in the output spectrum that is not present at the input, excluding d.c.

TOTAL HARMONIC DISTORTION (THD) is the ratio expressed in dB, of the rms total of the first nine harmonic levels at the output to the level of the fundamental at the output. THD is calculated as

$$\text{THD} = 20 \times \log \sqrt{\frac{A_{f2}^2 + \dots + A_{f10}^2}{A_{f1}^2}}$$

where A_{f1} is the RMS power of the fundamental (output) frequency and A_{f2} through A_{f10} are the RMS power of the first 9 harmonic frequencies in the output spectrum.

– **Second Harmonic Distortion (2nd Harm)** is the difference, expressed in dB, between the RMS power in the input frequency seen at the output and the power in its 2nd harmonic level at the output.

– **Third Harmonic Distortion (3rd Harm)** is the difference expressed in dB between the RMS power in the input frequency seen at the output and the power in its 3rd harmonic level at the output.

Transfer Characteristic

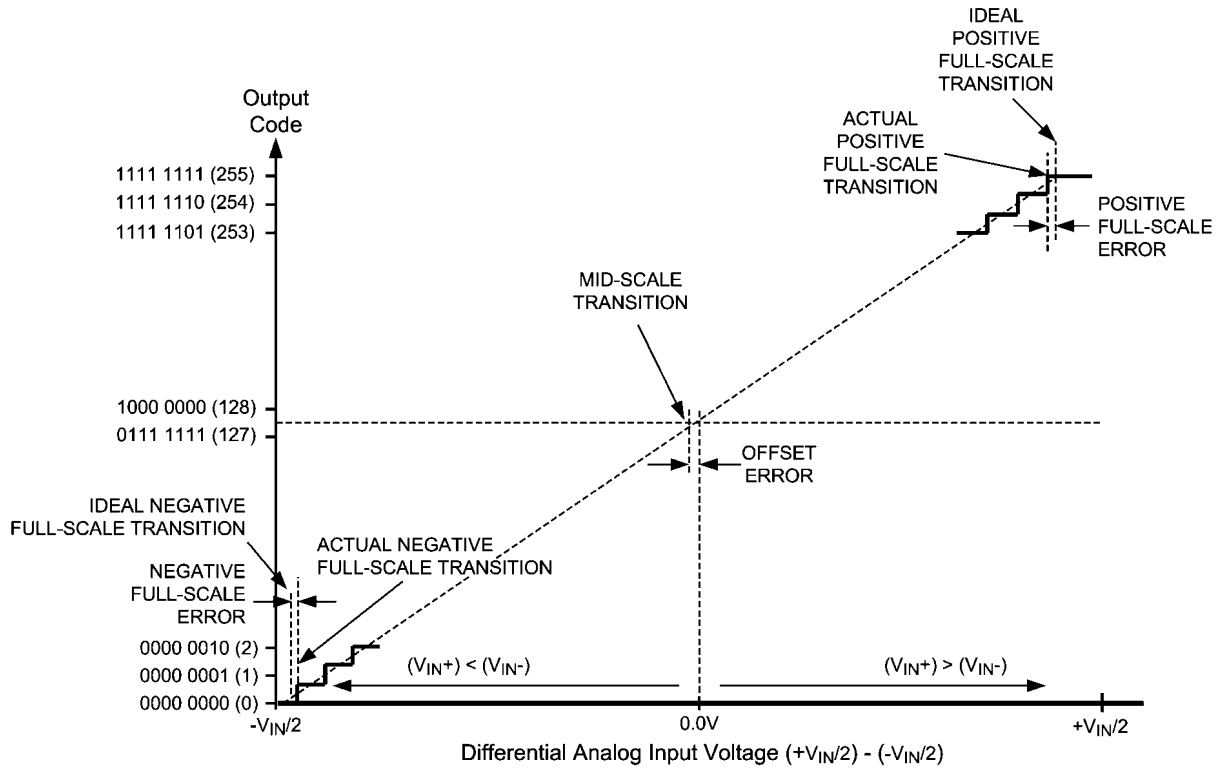

20206222

FIGURE 2. Input / Output Transfer Characteristic

Timing Diagrams

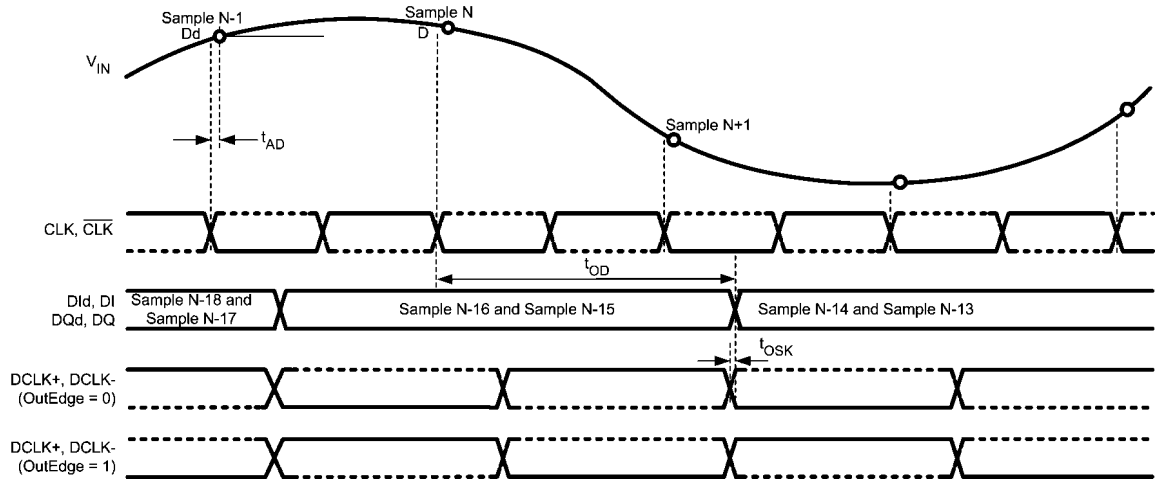

FIGURE 3. ADC08D1020 Timing — SDR Clcking in 1:2 Demultiplexed Mode

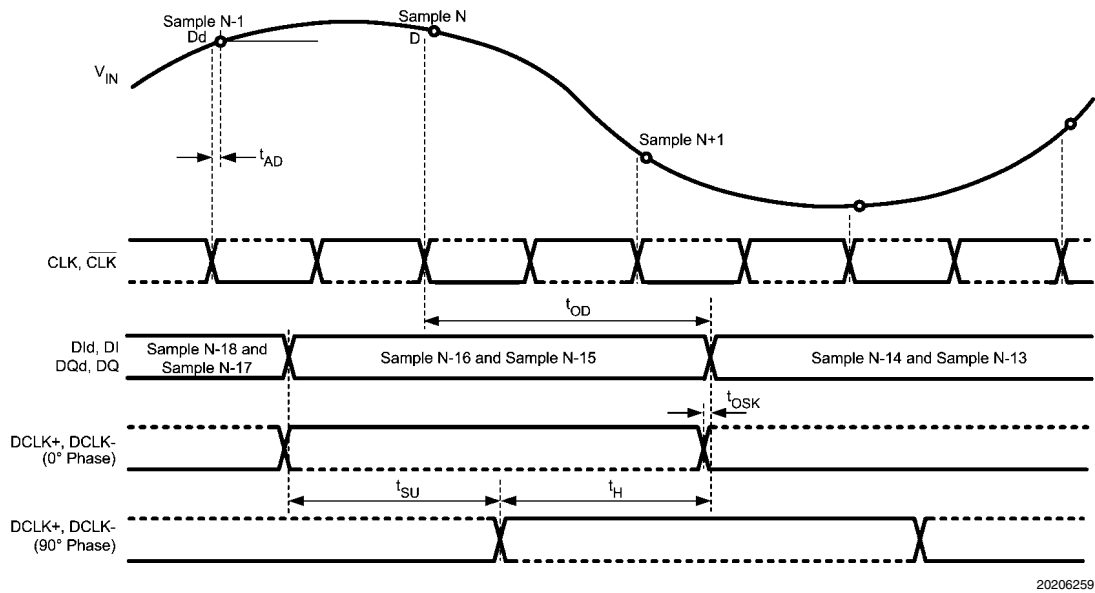
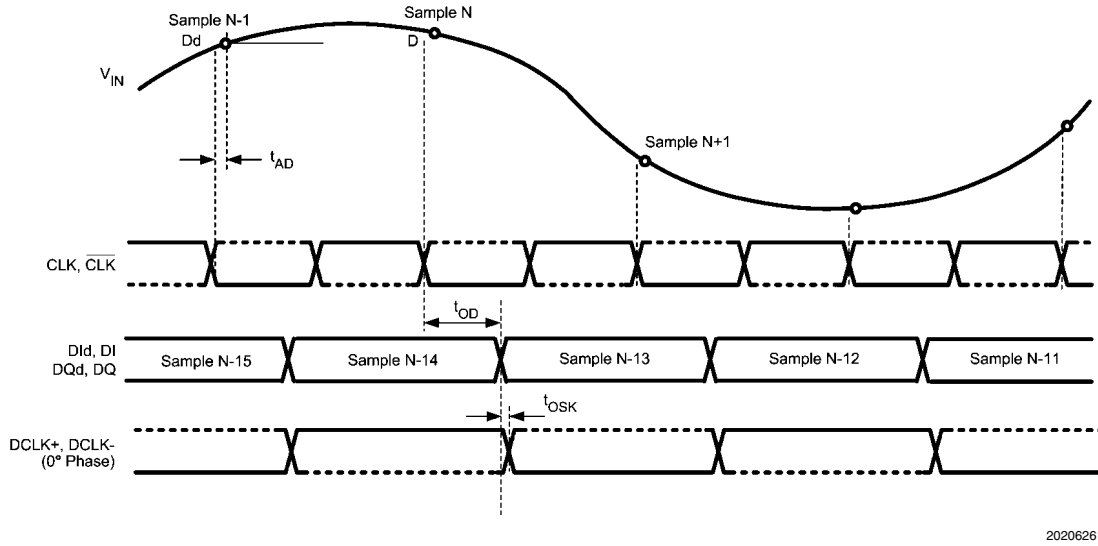
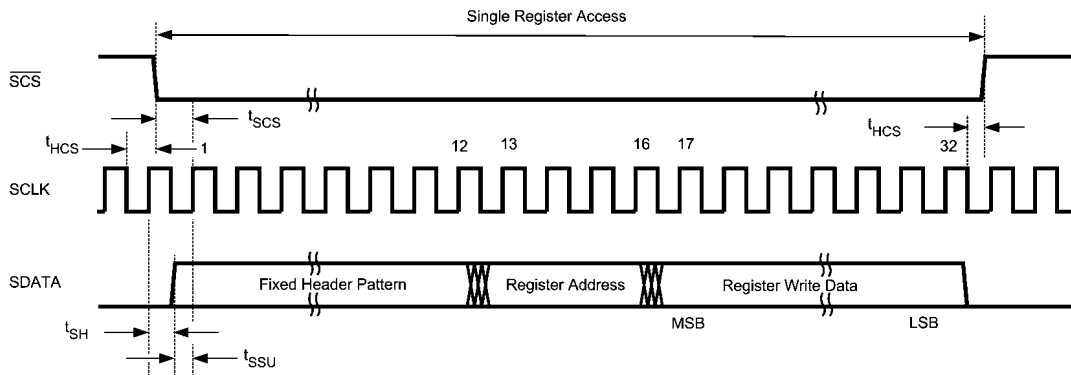

FIGURE 4. ADC08D1020 Timing — DDR Clcking in 1:2 Demultiplexed and Normal Mode



20206261

FIGURE 5. ADC08D1020 Timing — DDR Clocking in Non-Demultiplexed and Normal Mode



20206219

FIGURE 6. Serial Interface Timing

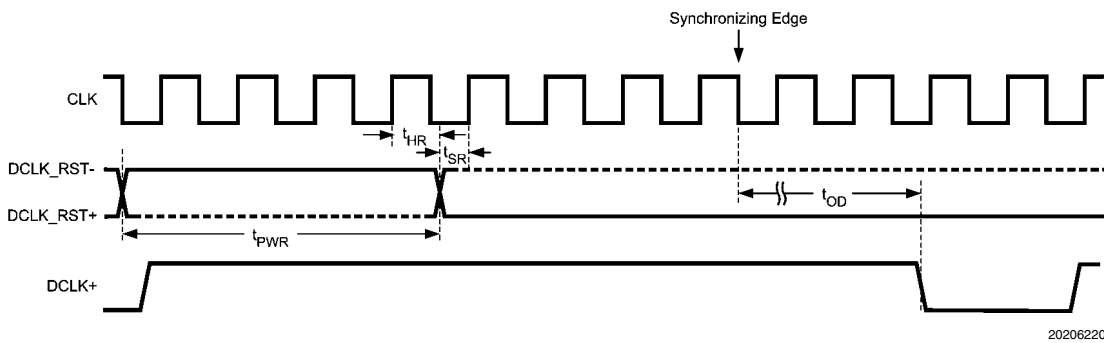

20206220

FIGURE 7. Clock Reset Timing in DDR Mode

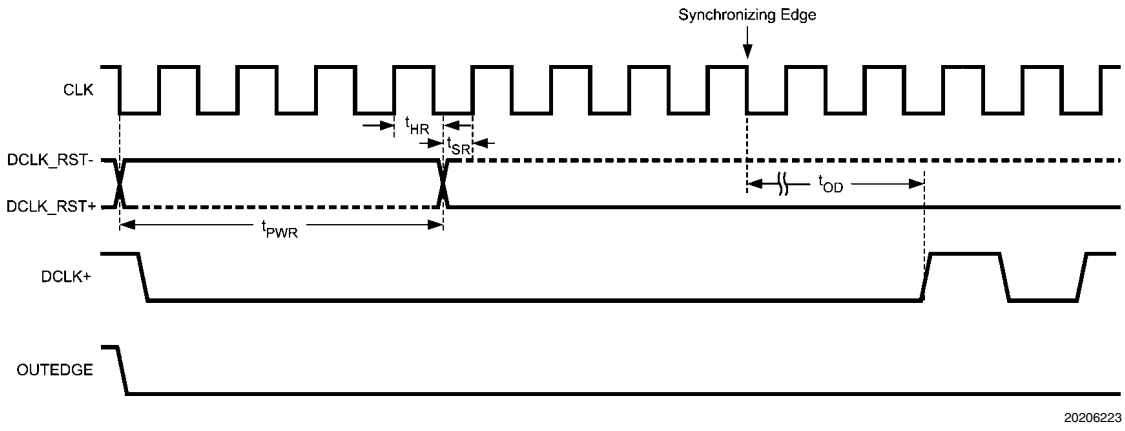

20206223

FIGURE 8. Clock Reset Timing in SDR Mode with OUTEDGE Low

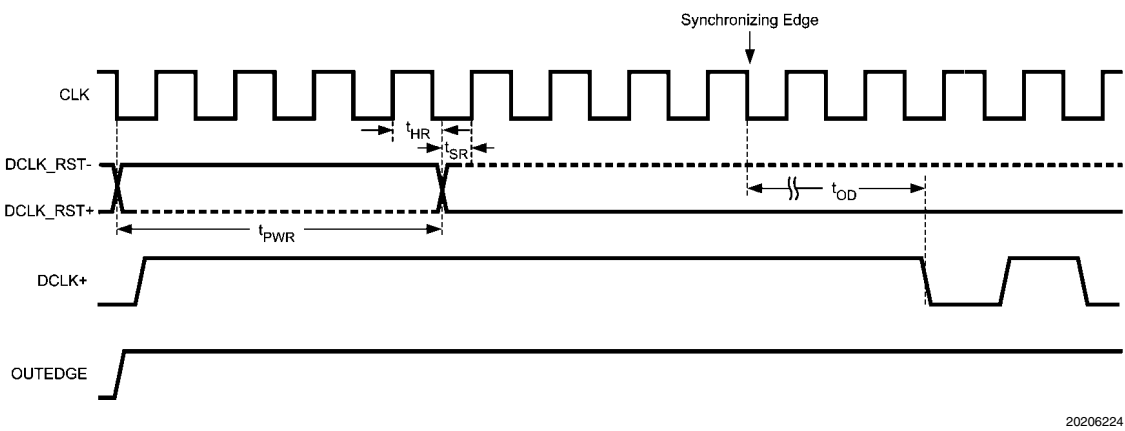

20206224

FIGURE 9. Clock Reset Timing in SDR Mode with OUTEDGE High

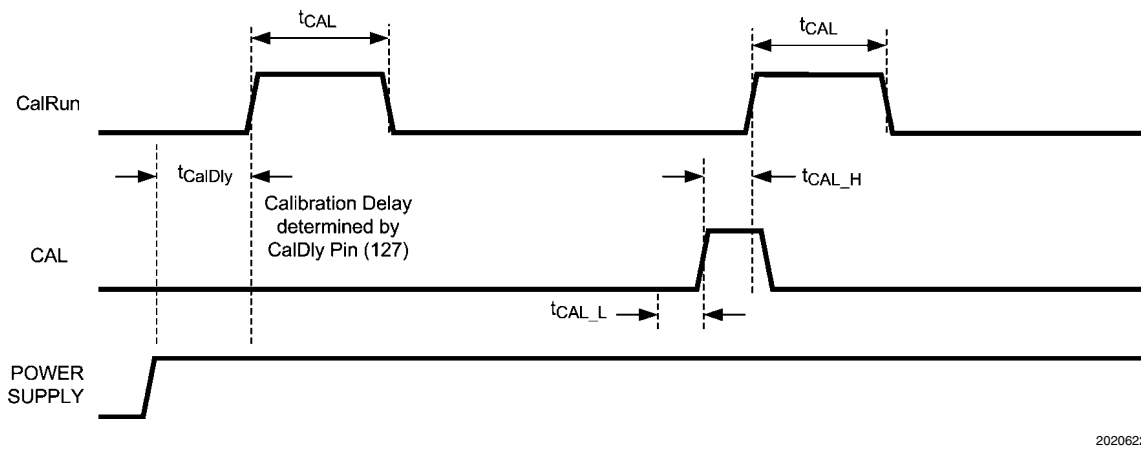

20206225

FIGURE 10. Power-up Calibration and On-Command Calibration Timing

Typical Performance Characteristics $V_A = V_{DR} = 1.9V$, $f_{CLK} = 1000\text{ MHz}$, $f_{IN} = 498\text{ MHz}$, $T_A = 25^\circ\text{C}$, 1 channel, 1:2 Demux Mode (1:1 Demux Mode has similar performance), unless otherwise stated.

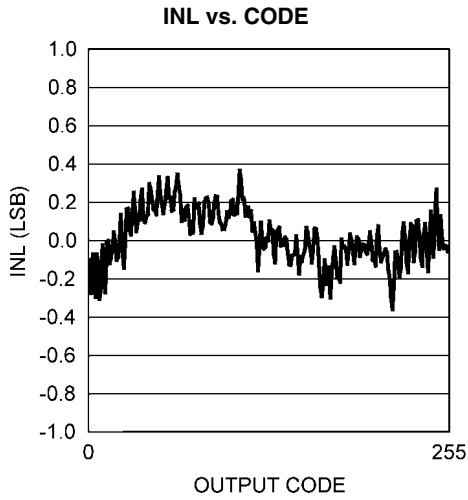

20206264

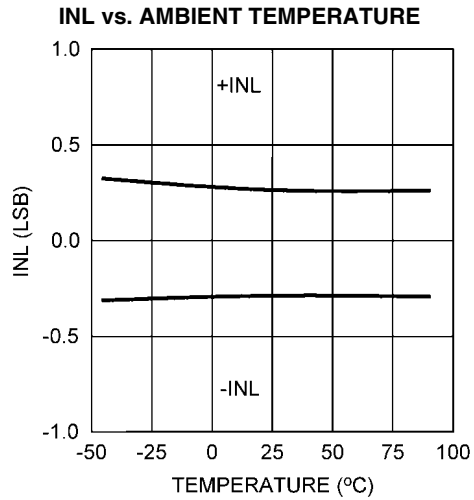

20206265

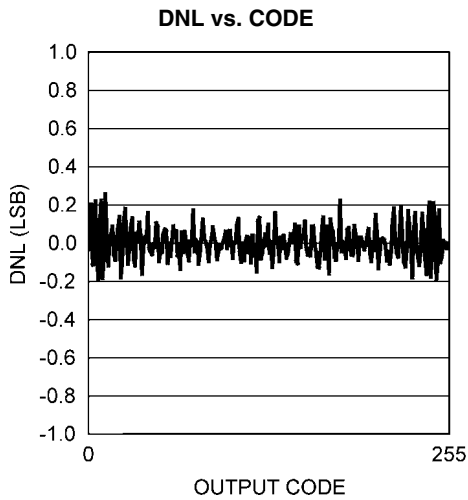

20206266

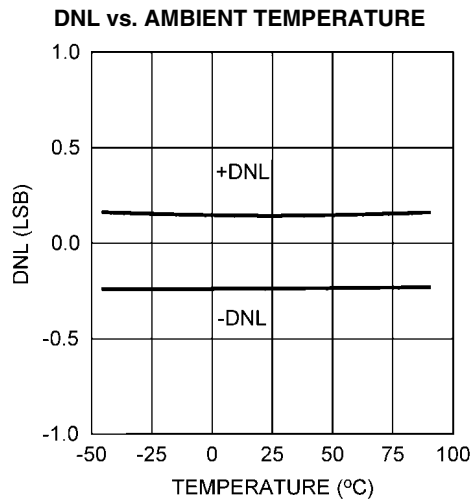

20206267

POWER CONSUMPTION vs. CLOCK FREQUENCY

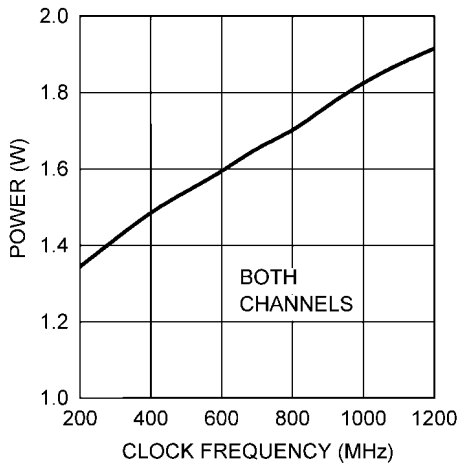

20206281

ENOB vs. AMBIENT TEMPERATURE

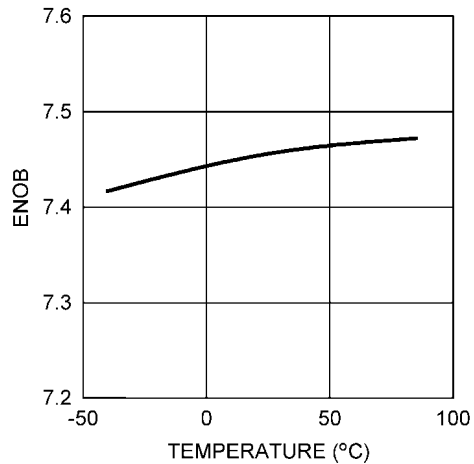

20206276

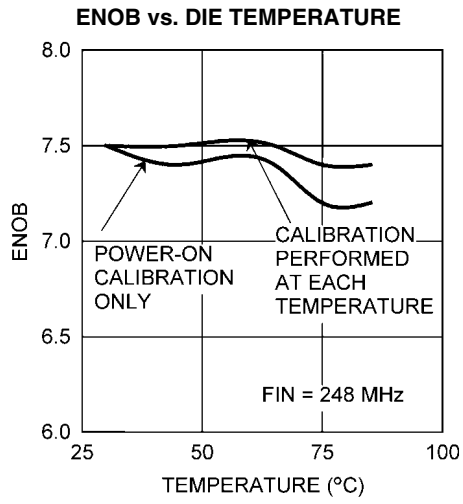

20206291

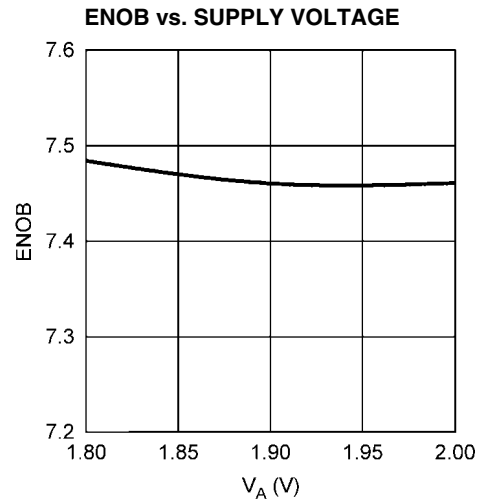

20206277

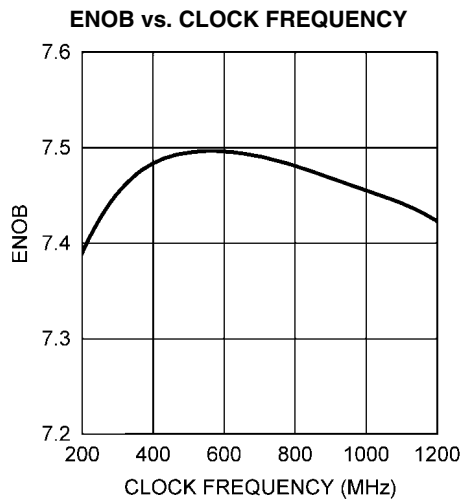

20206278

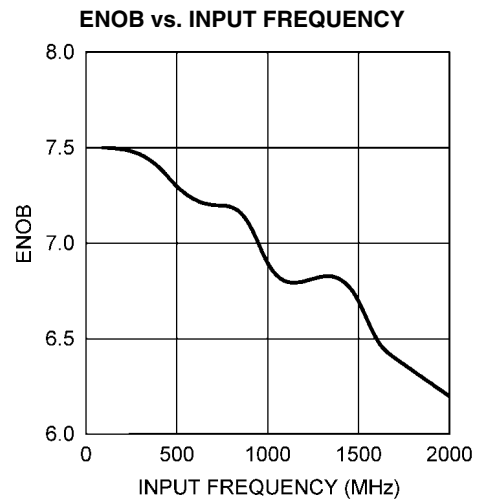

20206279

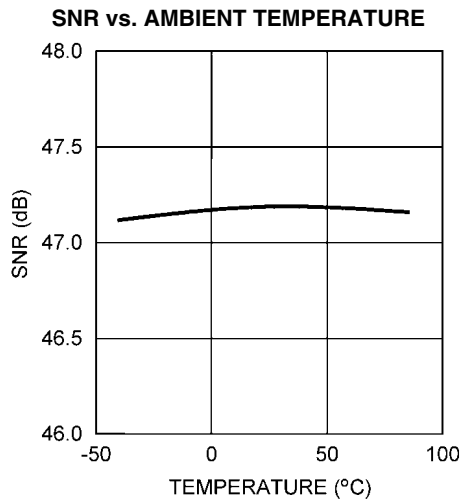

20206268

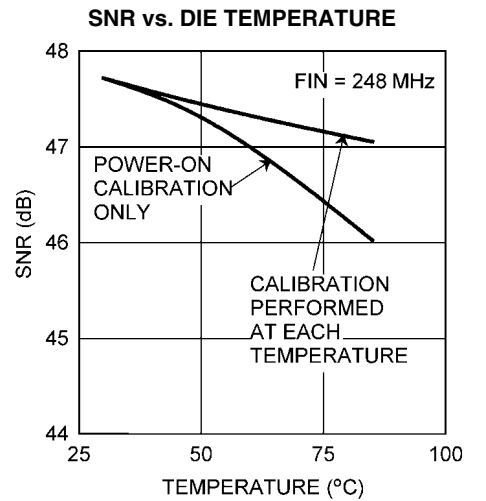

20206293

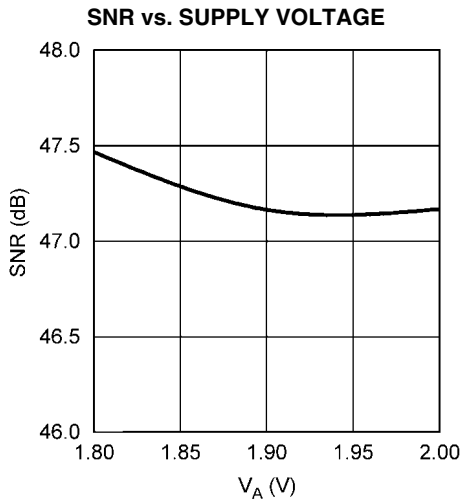

20206269

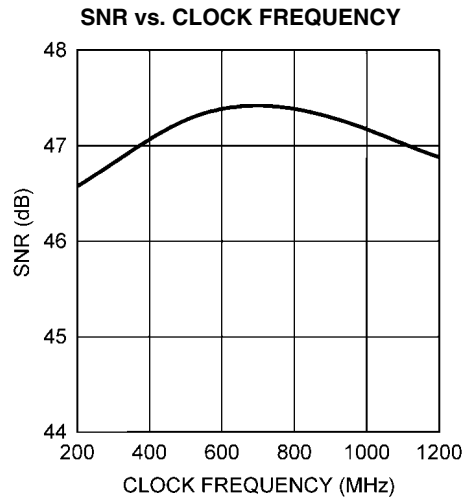

20206270

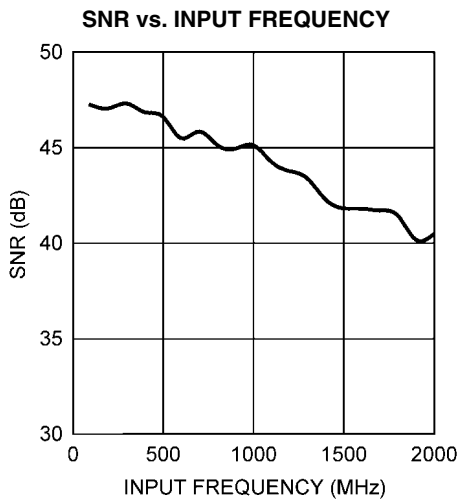

20206271

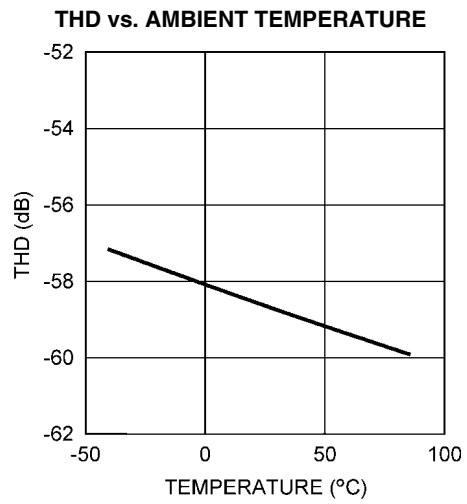

20206272

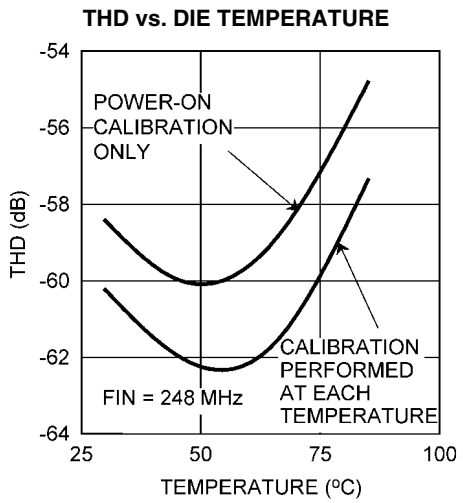

20206294

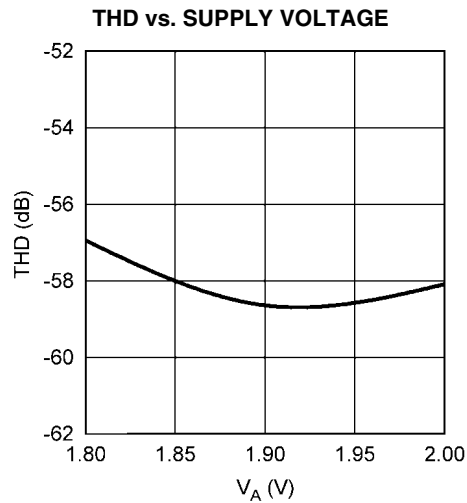

20206273

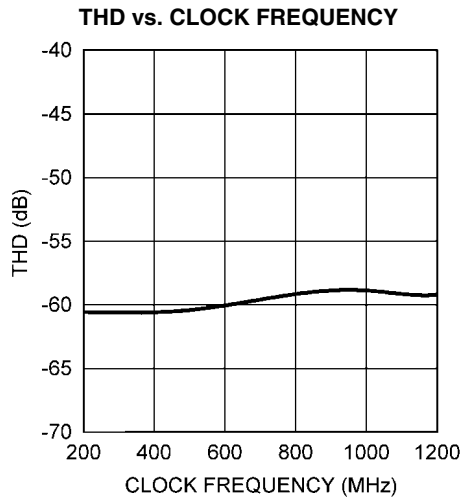

20206274

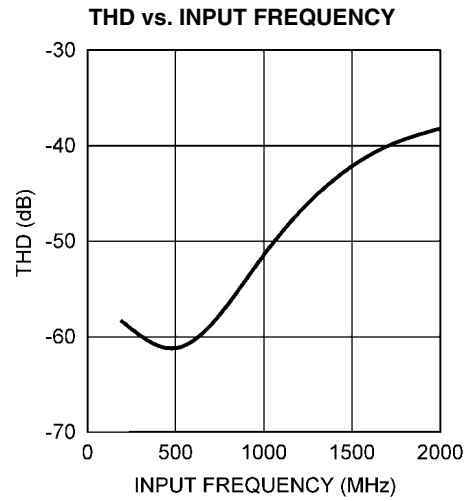

20206275

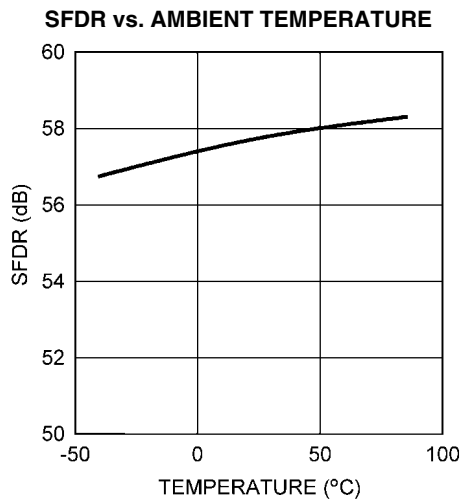

20206285

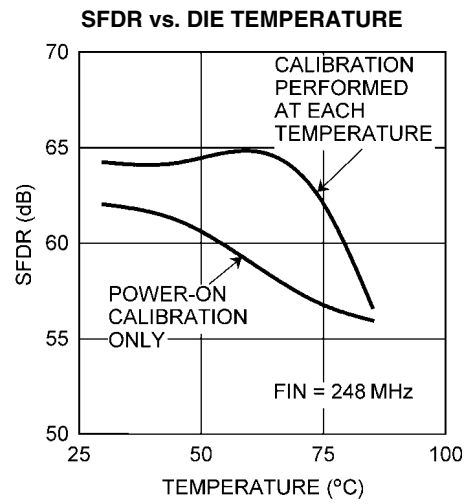

20206292

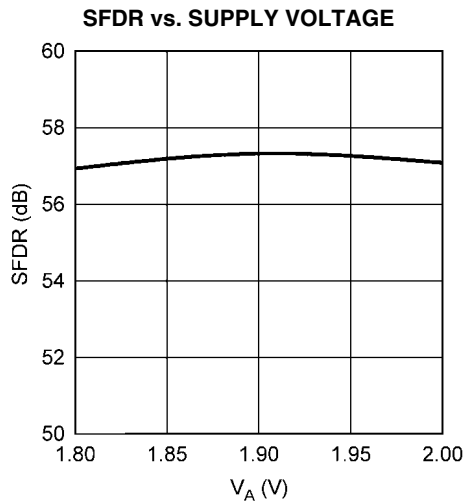

20206284

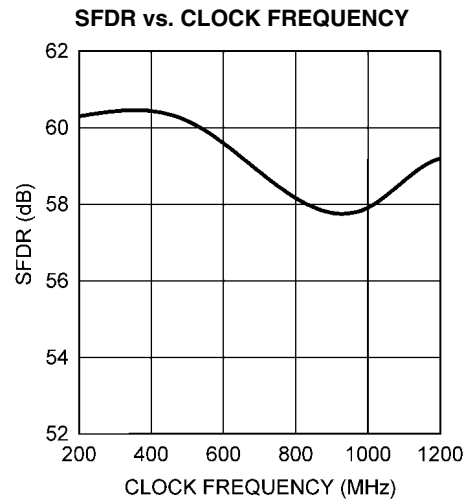

20206282

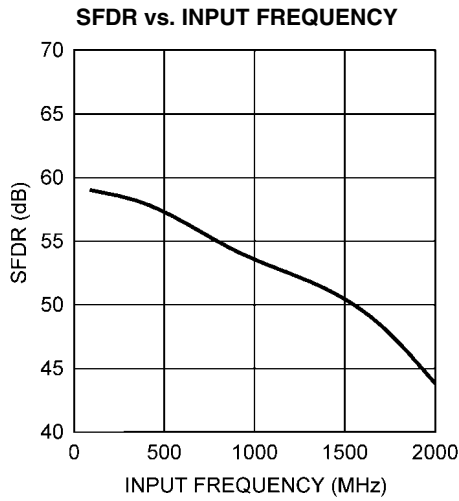

20206283

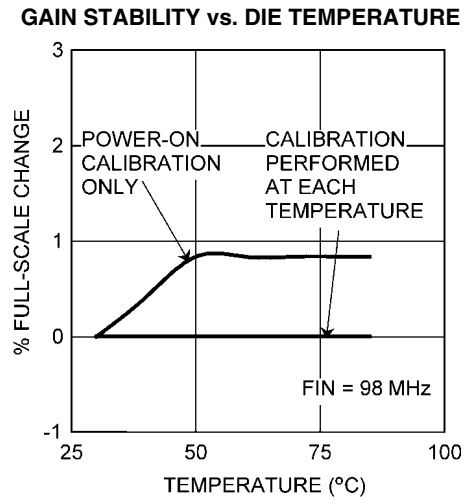

20206295

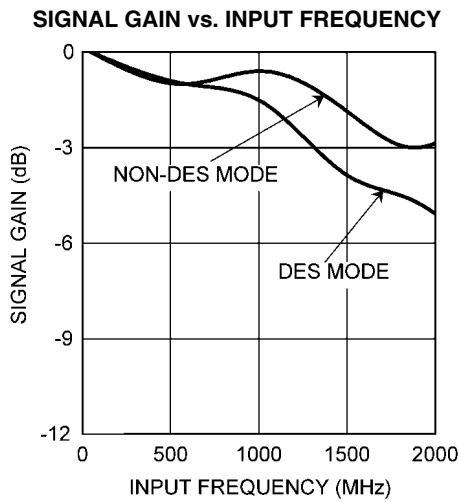

20206298

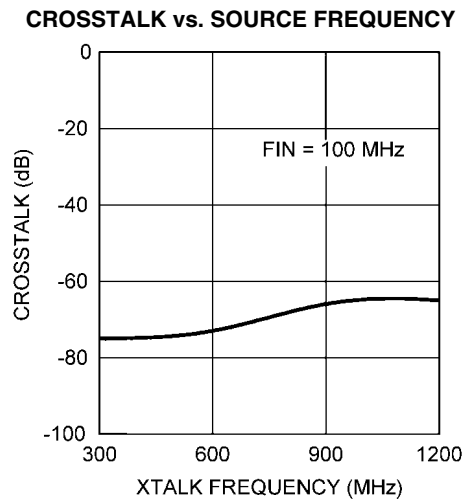

20206263

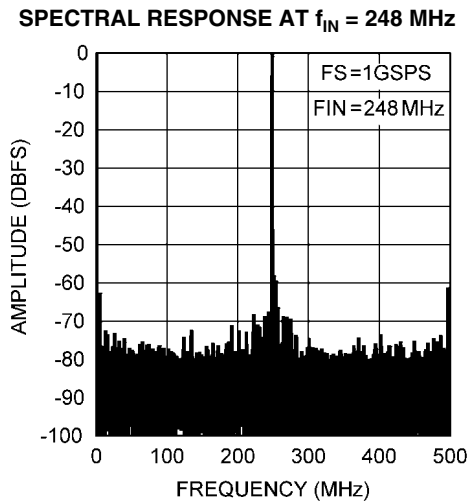

20206287

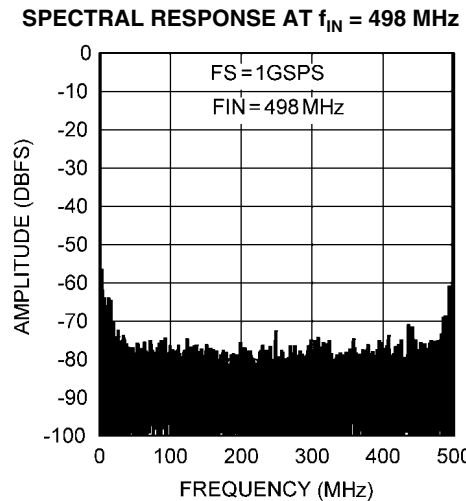

20206288

1.0 Functional Description

The ADC08D1020 is a versatile A/D Converter with an innovative architecture permitting very high speed operation. The controls available ease the application of the device to circuit solutions. Optimum performance requires adherence to the provisions discussed here and in the Applications Information Section.

While it is generally poor practice to allow an active pin to float, pins 4, 14 and 127 of the ADC08D1020 are designed to be left floating without jeopardy. In all discussions throughout this data sheet, whenever a function is called by allowing a control pin to float, connecting that pin to a potential of one half the V_A supply voltage will have the same effect as allowing it to float.

1.1 OVERVIEW

The ADC08D1020 uses a calibrated folding and interpolating architecture that achieves 7.4 effective bits. The use of folding amplifiers greatly reduces the number of comparators and power consumption. Interpolation reduces the number of front-end amplifiers required, minimizing the load on the input signal and further reducing power requirements. In addition to other things, on-chip calibration reduces the INL bow often seen with folding architectures. The result is an extremely fast, high performance, low power converter.

The analog input signal that is within the converter's input voltage range is digitized to eight bits at speeds of 200 MSPS to 1.3 GSPS, typical. Differential input voltages below negative full-scale will cause the output word to consist of all zeroes. Differential input voltages above positive full-scale will cause the output word to consist of all ones. Either of these conditions at either the "I" or "Q" input will cause the OR (Out of Range) output to be activated. This single OR output indicates when the output code from one or both of the channels is below negative full scale or above positive full scale.

Each converter has a selectable output demultiplexer which feeds two LVDS buses. If the 1:2 demultiplexed mode is selected, the output data rate is reduced to half the input sample rate on each bus. When non-demultiplexed mode is selected, that output data rate on channels DI and DQ are at the same rate as the input sample clock.

The output levels may be selected to be normal or reduced. Using reduced levels saves power but could result in erroneous data capture of some or all of the bits, especially at higher sample rates and in marginally designed systems.

1.1.1 Calibration

A calibration is performed upon power-up and can also be invoked by the user upon command. Calibration trims the 100 Ω analog input differential termination resistor and minimizes full-scale error, offset error, DNL and INL, resulting in maximizing SNR, THD, SINAD (SNDR) and ENOB. Internal bias currents are also set with the calibration process. All of this is true whether the calibration is performed upon power up or is performed upon command. Running the calibration is an important part of this chip's functionality and is required in order to obtain adequate performance. In addition to the requirement to be run at power-up, an on-command calibration must be run whenever the sense of the FSR pin is changed. For best performance, we recommend that an on-command calibration be run 20 seconds or more after application of power and whenever the operating temperature changes significantly relative to the specific system performance requirements. See [2.4.2.2 On-Command Calibration](#) for more information. Calibration can not be initiated or run while the device is in the power-down mode. See [1.1.7 Power Down](#) for

information on the interaction between Power Down and Calibration.

In normal operation, calibration is performed just after application of power and whenever a valid calibration command is given, which is holding the CAL pin low for at least t_{CAL_L} clock cycles, then hold it high for at least another t_{CAL_H} clock cycles as defined in the Converter Electrical Characteristics. The time taken by the calibration procedure is specified as t_{CAL} in Converter Electrical Characteristics. Holding the CAL pin high upon power up will prevent the calibration process from running until the CAL pin experiences the above-mentioned t_{CAL_L} clock cycles followed by t_{CAL_H} clock cycles.

CalDly (pin 127) is used to select one of two delay times that apply from the application of power to the start of calibration. This calibration delay time is dependent on the setting of the CalDly pin and is specified as t_{CALDly} in the Converter Electrical Characteristics. These delay values allow the power supply to come up and stabilize before calibration takes place. If the PD pin is high upon power-up, the calibration delay counter will be disabled until the PD pin is brought low. Therefore, holding the PD pin high during power up will further delay the start of the power-up calibration cycle. The best setting of the CalDly pin depends upon the power-on settling time of the power supply.

The CAL bit does not reset itself to zero automatically, but must be manually reset before another calibration event can be initiated. If no further calibration event is desired, the CAL bit may be left high indefinitely, with no negative consequences. The RTD bit setting is critical for running a calibration event with the Clock Phase Adjust enabled. If initiating a calibration event while the Clock Phase Adjust is enabled, the RTD bit must be set to high, or no calibration will occur. If initiating a calibration event while the Clock Phase Adjust is not enabled, a normal calibration will occur, regardless of the setting of the RTD bit.

1.1.2 Acquiring the Input

In 1:2 demux mode, data is acquired at the falling edge of CLK+ (pin 18) and the digital equivalent of that data is available at the digital outputs 13 input clock cycles later for the DI and DQ output buses and 14 input clock cycles later for the DI_d and DQ_d output buses. There is an additional internal delay called t_{OD} before the data is available at the outputs. See the Timing Diagram. The ADC08D1020 will convert as long as the input clock signal is present. The fully differential comparator design and the innovative design of the sample-and-hold amplifier, together with calibration, enables a very flat SINAD/ENOB response beyond 1 GHz. The ADC08D1020 output data signaling is LVDS and the output format is offset binary.

1.1.3 Control Modes

Much of the user control can be accomplished with several control pins that are provided. Examples include initiation of the calibration cycle, power down mode and full scale range setting. However, the ADC08D1020 also provides an Extended Control mode whereby a serial interface is used to access register-based control of several advanced features. The Extended Control mode is not intended to be enabled and disabled dynamically. Rather, the user is expected to employ either the normal control mode or the Extended Control mode at all times. When the device is in the Extended Control mode, pin-based control of several features is replaced with register-based control and those pin-based controls are disabled. These pins are OutV (pin 3), OutEdge/DDR (pin 4), FSR (pin 14) and CalDly/DES (pin 127). See [1.2 NORMAL/EXTENDED CONTROL](#) for details on the Extended Control mode.

1.1.4 The Analog Inputs

The ADC08D1020 must be driven with a differential input signal. Operation with a single-ended signal is not recommended. It is important that the inputs either be a.c. coupled to the inputs with the V_{CMO} pin grounded, or d.c. coupled with the V_{CMO} pin left floating. An input common mode voltage equal to the V_{CMO} output must be provided when d.c. coupling is used.

Two full-scale range settings are provided with pin 14 (FSR). A high on pin 14 causes an input full-scale range setting of a higher V_{IN} input level, while grounding pin 14 causes an input full-scale range setting of a reduced V_{IN} input level. The full-scale range setting operates equally on both ADCs.

In the Extended Control mode, programming the Input Full-Scale Voltage Adjust register allows the input full-scale range to be adjusted as described in [1.4 REGISTER DESCRIPTION](#) and [2.2 THE ANALOG INPUT](#).

1.1.5 Clocking

The ADC08D1020 must be driven with an a.c. coupled, differential clock signal. [2.3 THE CLOCK INPUTS](#) describes the use of the clock input pins. A differential LVDS output clock is available for use in latching the ADC output data into whatever device is used to receive the data.

The ADC08D1020 offers input and output clocking options. These options include a choice of Dual Edge Sampling (DES) or "interleaved mode" where the ADC08D1020 performs as a single device converting at twice the input clock rate, a choice of which DCLK edge the output data transitions on, and a choice of Single Data Rate (SDR) or Double Data Rate (DDR) outputs.

The ADC08D1020 also has the option to use a duty cycle corrected clock receiver as part of the input clock circuit. This feature is enabled by default and provides improved ADC clocking especially in the Dual-Edge Sampling mode (DES).

This circuitry allows the ADC to be clocked with a signal source having a duty cycle ratio of 20% / 80% (worst case) for both the normal and the Dual Edge Sampling modes.

1.1.5.1 Dual-Edge Sampling

The DES mode allows one of the ADC08D1020's inputs (I or Q Channel) to be sampled by both ADCs. One ADC samples the input on the positive edge of the input clock and the other ADC samples the same input on the falling edge of the input clock. A single input is thus sampled twice per input clock cycle, resulting in an overall sample rate of twice the input clock frequency, or 2 GSPS with a 1 GHz input clock.

In this mode, the outputs must be carefully interleaved to reconstruct the sampled signal. If the device is programmed into the 1:2 demultiplex mode while in DES mode, the data is effectively demultiplexed 1:4. If the input clock is 1 GHz, the effective sampling rate is doubled to 2 GSPS and each of the 4 output buses have a 500 MHz output rate. All data is available in parallel. To properly reconstruct the sampled waveform, the four bytes of parallel data that are output with each clock are in the following sampling order from the earliest to the latest and must be interleaved as such: DQd, DI, DQ, DI. See [Table 1](#) indicates what the outputs represent for the various sampling possibilities. If the device is programmed into the non-demultiplex mode, two bytes of parallel data are output with each edge of the clock in the following sampling order, from the earliest to the latest: DQ, DI. See [Table 2](#).

In the non-extended mode of operation only the "I" input can be sampled in the DES mode. In the extended mode of operation, the user can select which input is sampled.

The ADC08D1020 includes an automatic clock phase background adjustment which is used in DES mode to automatically and continuously adjust the clock phase of the I and Q channel. This feature provides optimal Dual-Edge Sampling performance.

TABLE 1. Input Channel Samples Produced at Data Outputs in 1:2 Demultiplexed Mode**

Data Outputs (Always sourced with respect to fall of DCLK +)	Normal Sampling Mode	Dual-Edge Sampling Mode (DES)	
		I-Channel Selected	Q-Channel Selected *
DI	"I" Input Sampled with Fall of CLK 13 cycles earlier.	"I" Input Sampled with Fall of CLK 13 cycles earlier.	"Q" Input Sampled with Fall of CLK 13 cycles earlier.
DI	"I" Input Sampled with Fall of CLK 14 cycles earlier.	"I" Input Sampled with Fall of CLK 14 cycles earlier.	"Q" Input Sampled with Fall of CLK 14 cycles earlier.
DQ	"Q" Input Sampled with Fall of CLK 13 cycles earlier.	"I" Input Sampled with Rise of CLK 13.5 cycles earlier.	"Q" Input Sampled with Rise of CLK 13.5 cycles earlier.
DQd	"Q" Input Sampled with Fall of CLK 14 cycles after being sampled.	"I" Input Sampled with Rise of CLK 14.5 cycles earlier.	"Q" Input Sampled with Rise of CLK 14.5 cycles earlier.

* Note that, in DES + normal mode, only the I Channel is sampled. In DES + extended control mode, I or Q channel can be sampled.

** Note that, in the non-demultiplexed mode, the DI and DQd outputs are disabled and are high impedance.

TABLE 2. Input Channel Samples Produced at Data Outputs in Non-Demultiplexed Mode

Data Outputs (Sourced with respect to fall of DCLK+)	Normal Mode	DES Mode
DI	"I" Input Sampled with Fall of CLK 13 cycles earlier.	Selected input sampled 13 cycles earlier.
DI _d	No output.	No output.
DQ	"Q" Input Sampled with Fall of CLK 13 cycles earlier.	Selected input sampled 13.5 cycles earlier.
DQ _d	No output.	No output.

1.1.5.2 OutEdge and Demultiplex Control Setting

To help ease data capture in the SDR mode, the output data may be caused to transition on either the positive or the negative edge of the output data clock (DCLK). In the non-extended control mode, this is chosen with the OutEdge input (pin 4). A high on the OutEdge input pin causes the output data to transition on the rising edge of DCLK+, while grounding this input causes the output to transition on the falling edge of DCLK+. See [2.4.3 Output Edge Synchronization](#). When in the extended control mode, the OutEdge is selected using the OED bit in the Configuration Register. This bit has two functions. In the single data rate (SDR) mode, the bit functions as OutEdge and selects the DCLK edge with which the data transitions. In the Double Data Rate (DDR) mode, this bit selects whether the device is in non-demultiplex or 1:2 demultiplex mode. In the DDR case, the DCLK has a 0° phase relationship with the output data independent of the demultiplexer selection. For 1:2 Demux DDR 0° Mode, there are four, as opposed to three cycles of CLK systematic delay from the Synchronizing Edge to the start of t_{OD} . See [1.5 MULTIPLE ADC SYNCHRONIZATION](#) for more details.

1.1.5.3 Single Data Rate and Double Data Rate

A choice of single data rate (SDR) or double data rate (DDR) output is offered. With single data rate the output clock (DCLK) frequency is the same as the data rate of the two output buses. With double data rate the DCLK frequency is half the data rate and data is sent to the outputs on both edges of DCLK. DDR clocking is enabled in non-Extended Control mode by allowing pin 4 to float.

1.1.6 The LVDS Outputs

The data outputs, the Out Of Range (OR) and DCLK, are LVDS. The electrical specifications of the LVDS outputs are compatible with typical LVDS receivers available on ASIC and FPGA chips; but they are not IEEE or ANSI communications standards compliant due to the low +1.9V supply used this chip. User is given the choice of a lower signal amplitude mode with OutV control pin or the OV control register bit. For short LVDS lines and low noise systems, satisfactory perfor-

mance may be realized with the OutV input low, which results in lower power consumption. If the LVDS lines are long and/or the system in which the ADC08D1020 is used is noisy, it may be necessary to tie the OutV pin high.

The LVDS data output have a typical common mode voltage of 800 mV when the V_{BG} pin is unconnected and floating. This common mode voltage can be increased to 1.175V by tying the V_{BG} pin to V_A if a higher common mode is required.

IMPORTANT NOTE: Tying the V_{BG} pin to V_A will also increase the differential LVDS output voltage by up to 40 mV.

1.1.7 Power Down

The ADC08D1020 is in the active state when the Power Down pin (PD) is low. When the PD pin is high, the device is in the power down mode. In this power down mode the data output pins (positive and negative) are put into a high impedance state and the devices power consumption is reduced to a minimal level. The DCLK+/- and OR +/- are not tri-stated, they are weakly pulled down to ground internally. Therefore when both I and Q are powered down the DCLK +/- and OR +/- should not be terminated to a DC voltage.

A high on the PDQ pin will power down the "Q" channel and leave the "I" channel active. There is no provision to power down the "I" channel independently of the "Q" channel. Upon return to normal operation, the pipeline will contain meaningless information.

If the PD input is brought high while a calibration is running, the device will not go into power down until the calibration sequence is complete. However, if power is applied and PD is already high, the device will not begin the calibration sequence until the PD input goes low. If a manual calibration is requested while the device is powered down, the calibration will not begin at all. That is, the manual calibration input is completely ignored in the power down state. Calibration will function with the "Q" channel powered down, but that channel will not be calibrated if PDQ is high. If the "Q" channel is subsequently to be used, it is necessary to perform a calibration after PDQ is brought low.

1.2 NORMAL/EXTENDED CONTROL

The ADC08D1020 may be operated in one of two modes. In the simpler standard control mode, the user affects available configuration and control of the device through several control pins. The "extended control mode" provides additional configuration and control options through a serial interface and a set of 9 registers. Extended control mode is selected by set-

ting pin 41 to logic low. If pin 41 is floating and pin 52 is floating or logic high, pin 14 can be used to enable the extended control mode. The choice of control modes is required to be a fixed selection and is not intended to be switched dynamically while the device is operational.

[Table 3](#) shows how several of the device features are affected by the control mode chosen.

TABLE 3. Features and Modes

Feature	Normal Control Mode	Extended Control Mode
SDR or DDR Clocking	Selected with pin 4	Selected with nDE in the Configuration Register (Addr-1h; bit-10).
DDR Clock Phase	Not Selectable (0° Phase Only)	Selected with DCP in the Configuration Register (Addr-1h; bit-11).
SDR Data transitions with rising or falling DCLK edge	SDR Data transitions with rising edge of DCLK+ when pin 4 is high and on falling edge when low.	Selected with OED in the Configuration Register (Addr-1h; bit-8).
LVDS output level	Normal differential data and DCLK amplitude selected when pin 3 is high and reduced amplitude selected when low.	Selected with OV in the Configuration Register (Addr-1h; bit-9).
Power-On Calibration Delay	Short delay selected when pin 127 is low and longer delay selected when high.	Short delay only.
Full-Scale Range	Normal input full-scale range selected when pin 14 is high and reduced range when low. Selected range applies to both channels.	Up to 512 step adjustments over a nominal range specified in 1.4 REGISTER DESCRIPTION . Separate range selected for I- and Q-Channels. Selected using Full Range Registers (Addr-3h and Bh; bit-7 thru 15).
Input Offset Adjust	Not possible	512 steps of adjustment using the Input Offset register specified in 1.4 REGISTER DESCRIPTION for each channel using Input Offset Registers (Addr-2h and Ah; bit-7 thru 15).
Dual Edge Sampling Selection	Enabled with pin 127 floating	Enabled by programming DES in the Extended Configuration Register (Addr-9h; bit-13).
Dual Edge Sampling Input Channel Selection	Only I-Channel Input can be used	Either I- or Q-Channel input may be sampled by both ADCs.
Test Pattern	Not possible	A test pattern can be made present at the data outputs by setting TPO to 1b in Extended Configuration Register (Addr-9h; bit-15).
Resistor Trim Disable	Not possible	The DCLK outputs will continuously be present when RTD is set to 1b in Extended Configuration Register (Addr-9h; bit-14 to 7).
Selectable Output Demultiplexer	Not possible	If the device is set in DDR, the output can be programmed to be non-demultiplex. When OED in Configuration Register is set 1b (Addr-1h; bit-8), this selects non-demultiplex. If OED is set 0b, this selects 1:2 demultiplex.
Second DCLK Output	Not possible	The OR outputs can be programmed to become a second DCLK output when nSD is set 0b in Configuration Register (Addr-1h; bit-13).
Sampling Clock Phase Adjust	Not possible	The sampling clock phase can be manually adjusted through the Coarse and Intermediate Register (Addr-Fh; bit-15-7) and Fine Register (Addr-Eh; bit-15 to 8).

The default state of the Extended Control Mode is set upon power-on reset (internally performed by the device) and is shown in [Table 4](#).

TABLE 4. Extended Control Mode Operation (Pin 41 Logic Low or Pin 14 Floating)

Feature	Extended Control Mode Default State
SDR or DDR Clocking	DDR Clocking
DDR Clock Phase	Data changes with DCLK edge (0° phase)
LVDS Output Amplitude	Higher value indicated in Electrical Table
Calibration Delay	Short Delay
Full-Scale Range	700 mV nominal for both channels
Input Offset Adjust	No adjustment for either channel
Dual Edge Sampling (DES)	Not enabled
Test Pattern	Not present at output
Resistor Trim Disable	Trim enabled, DCLK not continuously present at output
Selectable Output Demultiplexer	1:2 demultiplex
Second DCLK Output	Not present, pins 79 and 80 function as OR+ and OR-
Sampling Clock Phase Adjust	No adjustment for fine, intermediate or coarse

1.3 THE SERIAL INTERFACE

IMPORTANT NOTE: During the initial write using the serial interface, all nine registers must be written with desired or default values. Subsequent writes to single registers are allowed.

The 3-pin serial interface is enabled only when the device is in the Extended Control mode. The pins of this interface are Serial Clock (SCLK), Serial Data (SDATA) and Serial Interface Chip Select (SCS). Nine write only registers are accessible through this serial interface.

SCS: This signal should be asserted low while accessing a register through the serial interface. Setup and hold times with respect to the SCLK must be observed.

SCLK: Serial data input is accepted at the rising edge of this signal. There is no minimum frequency requirement for SCLK.

SDATA: Each register access requires a specific 32-bit pattern at this input. This pattern consists of a header, register address and register value. The data is shifted in MSB first. Setup and hold times with respect to the SCLK must be observed. See the Timing Diagram.

Each Register access consists of 32 bits, as shown in [Figure 6](#) of the Timing Diagrams. The fixed header pattern is 0000 0000 0001 (eleven zeros followed by a 1). The loading sequence is such that a "0" is loaded first. These 12 bits form the header. The next 4 bits are the address of the register that is to be written to and the last 16 bits are the data written to the addressed register. The addresses of the various registers are indicated in [Table 5](#).

Refer to the Register Description ([1.4 REGISTER DESCRIPTION](#)) for information on the data to be written to the registers. Subsequent register accesses may be performed immediately, starting with the 33rd SCLK. This means that the SCS input does not have to be de-asserted and asserted again between register addresses. It is possible, although not recommended, to keep the SCS input permanently enabled (at a logic low) when using extended control.

Control register contents are retained when the device is put into power-down mode.

IMPORTANT NOTE: Do not write to the Serial Interface when calibrating the ADC. Doing so will impair the performance of the device until it is re-calibrated correctly. Programming the serial registers will also reduce dynamic performance of the ADC for the duration of the register access time.

TABLE 5. Register Addresses

4-Bit Address					
Loading Sequence: A3 loaded after Fixed Header pattern, A0 loaded last					
A3	A2	A1	A0	Hex	Register Addressed
0	0	0	0	0h	Calibration
0	0	0	1	1h	Configuration
0	0	1	0	2h	"I" Ch Offset
0	0	1	1	3h	"I" Ch Full-Scale Voltage Adjust
0	1	0	0	4h	Reserved
0	1	0	1	5h	Reserved
0	1	1	0	6h	Reserved
0	1	1	1	7h	Reserved
1	0	0	0	8h	Reserved
1	0	0	1	9h	Extended Configuration
1	0	1	0	Ah	"Q" Ch Offset
1	0	1	1	Bh	"Q" Ch Full-Scale Voltage Adjust
1	1	0	0	Ch	Reserved
1	1	0	1	Dh	Reserved
1	1	1	0	Eh	Sampling Clock Phase Fine Adjust
1	1	1	1	Fh	Sample Clock Phase Intermediate and Coarse Adjust

1.4 REGISTER DESCRIPTION

Nine write-only registers provide several control and configuration options in the Extended Control Mode. These registers have no effect when the device is in the Normal Control Mode. Each register description below also shows the Power-On Reset (POR) state of each control bit.

Calibration Register

Addr: 0h (0000b) Write only (0x7FFF)

D15	D14	D13	D12	D11	D10	D9	D8
CAL	1	1	1	1	1	1	1

D7	D6	D5	D4	D3	D2	D1	D0
1	1	1	1	1	1	1	1

Bit 15 CAL: Calibration Enable. When this bit is set to 1b, an on-command calibration cycle is initiated. This function is exactly the same as issuing an on-command calibration using the CAL pin.

POR State: 0b

Bits 14:0 Must be set to 1b

Configuration Register

Addr: 1h (0001b) Write only (0xB2FF)

D15	D14	D13	D12	D11	D10	D9	D8
1	0	nSD	DCS	DCP	nDE	OV	OED

D7	D6	D5	D4	D3	D2	D1	D0
1	1	1	1	1	1	1	1

Bit 15 Must be set to 1b

Bit 14 Must be set to 0b

Bit 13 nSD: Second DCLK Output Enable. When this bit is 1b, the device only has one DCLK output and one OR output. When this bit is 0b, the device has two identical DCLK outputs and no OR output.

POR State: 1b

Bit 12 DCS: Duty Cycle Stabilizer. When this bit is set to 1b, a duty cycle stabilization circuit is applied to the clock input. When this bit is set to 0b the stabilization circuit is disabled.

POR State: 1b

Bit 11 DCP: DDR Clock Phase. This bit only has an effect in the DDR mode. When this bit is set to 0b, the DCLK edges are time-aligned with the data bus edges ("0° Phase"). When this bit is set to 1b, the DCLK edges are placed in the middle of the data bit-cells ("90° Phase"), using the one-half speed DCLK shown in [Figure 4](#) as the phase reference.

POR State: 0b

Bit 10 nDE: DDR Enable. When this bit is set to 0b, data bus clocking follows the DDR (Double Data Rate) mode whereby a data word is output with each rising and falling edge of DCLK. When this bit is set to a 1b, data bus clocking follows the SDR (single data rate) mode whereby each data word is output with either the rising or falling edge of DCLK, as determined by the OutEdge bit.

POR State: 0b

Bit 9 OV: Output Voltage. This bit determines the LVDS outputs' voltage amplitude and has the same function as the OutV pin that is used in the normal control mode. When this bit is set to 1b, the standard output amplitude of 710 mV_{P-P} is used. When this bit is set to 0b, the reduced output amplitude of 510 mV_{P-P} is used.

POR State: 1b

Bit 8 OED: Output Edge and Demultiplex Control. This bit has two functions. When the device is in SDR mode, this bit selects the DCLK edge with which the data words transition and has the same effect as the OutEdge pin in the Non-extended control mode. When this bit is set to 1b, the data outputs change with the rising edge of DCLK+. When this bit is set to 0b, the data output changes with the falling edge of DCLK+. When the device is in DDR mode, this bit selects the non-demultiplexed mode when set to 1b. When the bit set to 0b, the device is programmed into the Demultiplexed mode. If the device is in DDR and Non-Demultiplexed Mode, then the DCLK has a 0° phase relationship with the data; it is not possible to select the 90° phase relationship.

POR State: 0b

Bits 7:0 Must be set to 1b

IMPORTANT NOTE: It is recommended that this register should only be written upon power-up initialization as writing it may cause disturbance on the DCLK output as this signal's basic configuration is changed.

I-Channel Offset**Addr: 2h (0010b) Write only (0x007F)**

D15	D14	D13	D12	D11	D10	D9	D8
(MSB)	Offset Value						(LSB)

D7	D6	D5	D4	D3	D2	D1	D0
Sign	1	1	1	1	1	1	1

Bits 15:8 Offset Value. The input offset of the I-Channel ADC is adjusted linearly and monotonically by the value in this field. 00h provides a nominal zero offset, while FFh provides a nominal 45 mV of offset. Thus, each code step provides 0.176 mV of offset.
POR State: 0000 0000 b

Bit 7 Sign bit. 0b gives positive offset, 1b gives negative offset, resulting in total offset adjustment of ± 45 mV.
POR State: 0b

Bits 6:0 Must be set to 1b

I-Channel Full-Scale Voltage Adjust**Addr: 3h (0011b) Write only (0x807F)**

D15	D14	D13	D12	D11	D10	D9	D8
(MSB)	Adjust Value						

D7	D6	D5	D4	D3	D2	D1	D0
(LSB)	1	1	1	1	1	1	1

Bits 15:7 Full Scale Voltage Adjust Value. The input full-scale voltage or gain of the I-Channel ADC is adjusted linearly and monotonically with a 9 bit data value. The adjustment range is $\pm 20\%$ of the nominal 700 mV_{P-P} differential value.

0000 0000 0 560 mV_{P-P}

1000 0000 0 700 mV_{P-P}

Default Value

1111 1111 1 840 mV_{P-P}

For best performance, it is recommended that the value in this field be limited to the range of 0110 0000 0b to 1110 0000 0b. i.e., limit the amount of adjustment to $\pm 15\%$. The remaining $\pm 5\%$ headroom allows for the ADC's own full scale variation. A gain adjustment does not require ADC re-calibration.

POR State: 1000 0000 0b (no adjustment)

Bits 6:0 Must be set to 1b

Extended Configuration Register**Addr: 9h (1001b) Write only (0x03FF)**

D15	D14	D13	D12	D11	D10	D9	D8
TPO	RTD	DES	IS	0	DLF	1	1

D7	D6	D5	D4	D3	D2	D1	D0
1	1	1	1	1	1	1	1

Bit 15 TPO: Test Pattern Output. When this bit is set 1b, the ADC is disengaged and a test pattern generator is connected to the outputs including OR. This test pattern will work with the device in the SDR, DDR and the non-demultiplex output modes.

POR State: 0b

Bit 14 RTD: Resistor Trim Disable. When this bit is set to 1b, the input termination resistor is not trimmed during the calibration cycle and the DCLK output remains enabled. Note that the ADC is calibrated regardless of this setting.

POR State: 0b

Bit 13 DES: DES Enable. Setting this bit to 1b enables the Dual Edge Sampling mode. In this mode the ADCs in this device are used to sample and convert the same analog input in a time-interleaved manner, accomplishing a sample rate of twice the input clock rate. When this bit is set to 0b, the device operates in the normal dual channel mode.

POR State: 0b

Bit 12 IS: Input Select. When this bit is set to 0b the "I" input is operated upon by both ADCs. When this bit is set to 1b the "Q" input is operated on by both ADCs.

POR State: 0b

Bit 11 Must be set to 0b

Bit 10 DLF: Low Frequency. When this bit is set 1b, the dynamic performance of the device is improved when the input clock is less than 900MHz.

POR State: 0b

Bits 9:0 Must be set to 1b

Q-Channel Offset**Addr: Ah (1010b) Write only (0x007F)**

D15	D14	D13	D12	D11	D10	D9	D8
(MSB)	Offset Value						(LSB)

D7	D6	D5	D4	D3	D2	D1	D0
Sign	1	1	1	1	1	1	1

Bits 15:8 Offset Value. The input offset of the Q-Channel ADC is adjusted linearly and monotonically by the value in this field. 00h provides a nominal zero offset, while FFh provides a nominal 45 mV of offset. Thus, each code step provides about 0.176 mV of offset.

POR State: 0000 0000 b

Bit 7 Sign bit. 0b gives positive offset, 1b gives negative offset.

POR State: 0b

Bits 6:0 Must be set to 1b

Q-Channel Full-Scale Voltage Adjust**Addr: Bh (1011b)****Write only (0x807F)**

D15	D14	D13	D12	D11	D10	D9	D8
Adjust Value							
(MSB)							(LSB)
D7	D6	D5	D4	D3	D2	D1	D0
(LSB)	1	1	1	1	1	1	1

Bits 15:7 Full Scale Voltage Adjust Value. The input full-scale voltage or gain of the I-Channel ADC is adjusted linearly and monotonically with a 9 bit data value. The adjustment range is $\pm 20\%$ of the nominal $700\text{ mV}_{\text{P-P}}$ differential value.

0000 0000 0 $560\text{ mV}_{\text{P-P}}$ 1000 0000 0 $700\text{ mV}_{\text{P-P}}$ 1111 1111 1 $840\text{ mV}_{\text{P-P}}$

For best performance, it is recommended that the value in this field be limited to the range of 0110 0000 0b to 1110 0000 0b. i.e., limit the amount of adjustment to $\pm 15\%$. The remaining $\pm 5\%$ headroom allows for the ADC's own full scale variation. A gain adjustment does not require ADC re-calibration.

POR State: 1000 0000 0b (no adjustment)

Bits 6:0 Must be set to 1b

Sample Clock Phase Fine Adjust**Addr: 1110****Write only (0x00FF)**

D15	D14	D13	D12	D11	D10	D9	D8
Fine Phase Adjust							
(MSB)							(LSB)
D7	D6	D5	D4	D3	D2	D1	D0
(LSB)	1	1	1	1	1	1	1

Bits 15:8 Fine Phase Adjust. The phase of the ADC sampling clock is adjusted monotonically by the value in this field. 00h provides a nominal zero phase adjustment, while FFh provides a nominal 50 ps of delay. Thus, each code step provides approximately 0.2 ps of delay.

POR State: 0000 0000b

Bits 7:0 Must be set to 1b

Sample Clock Phase Intermediate/Coarse Adjust**Addr: Fh (1111b)****Write only (0x007F)**

D15	D14	D13	D12	D11	D10	D9	D8
POL	(MSB) Coarse Phase Adjust						IPA
D7	D6	D5	D4	D3	D2	D1	D0
(LSB)	1	1	1	1	1	1	1

Bit 15 Polarity Select. When this bit is selected, the polarity of the ADC sampling clock is inverted.

POR State: 0b

Bits 14:10 Coarse Phase Adjust. Each code value in this field delays the sample clock by approximately 65 ps. A value of 00000b in this field causes zero adjustment.

POR State: 00000b

Bits 9:7 Intermediate Phase Adjust. Each code value in this field delays the sample clock by approximately 11 ps. A value of 000b in this field causes zero adjustment. Maximum combined adjustment using Coarse Phase Adjust and Intermediate Phase adjust is approximately 2.1ns.

POR State: 000b

Bits 6:0 Must be set to 1b

1.4.1 Note Regarding Clock Phase Adjust

This is a feature intended to help the system designer remove small imbalances in clock distribution traces at the board level when multiple ADCs are used. Please note, however, that enabling this feature will reduce the dynamic performance (ENOB, SNR, SFDR) some finite amount. The amount of degradation increases with the amount of adjustment applied. The user is strongly advised to (a) use the minimal amount of adjustment; and (b) verify the net benefit of this feature in his system before relying on it.

1.4.2 Note Regarding Extended Mode Offset Correction

When using the I or Q channel Offset Adjust registers, the following information should be noted.

For offset values of +0000 0000 and -0000 0000, the actual offset is not the same. By changing only the sign bit in this case, an offset step in the digital output code of about 1/10th of an LSB is experienced. This is shown more clearly in the Figure below.

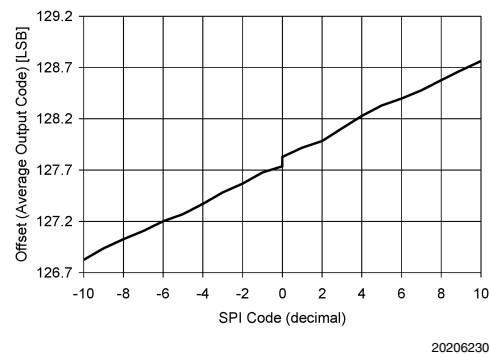
**FIGURE 11. Extended Mode Offset Behavior****1.5 MULTIPLE ADC SYNCHRONIZATION**

The ADC08D1020 has the capability to precisely reset its sampling clock input to DCLK output relationship as determined by the user-supplied DCLK_RST pulse. This allows multiple ADCs in a system to have their DCLK (and data) outputs transition at the same time with respect to the shared CLK input that all the ADCs use for sampling.

The DCLK_RST signal must observe some timing requirements that are shown in [Figure 7](#), [Figure 8](#) and [Figure 9](#) of the Timing Diagrams. The DCLK_RST pulse must be of a mini-

imum width and its deassertion edge must observe setup and hold times with respect to the CLK input rising edge. The duration of the DCLK_RST pulse affects the length of time that the digital output will take before providing valid data again after the end of the reset condition. Therefore, the DCLK_RST pulse width should be made reasonably short within the system application constraints. These timing specifications are listed as t_{RH} , t_{RS} , and t_{PWR} in the Converter Electrical Characteristics.

The DCLK_RST signal can be asserted asynchronous to the input clock. If DCLK_RST is asserted, the DCLK output is held in a designated state. The state in which DCLK is held during the reset period is determined by the mode of operation (SDR/DDR) and the setting of the Output Edge configuration pin or bit. (Refer to [Figure 7](#), [Figure 8](#) and [Figure 9](#) for the DCLK reset state conditions). Therefore, depending upon when the DCLK_RST signal is asserted, there may be a narrow pulse on the DCLK line during this reset event. When the DCLK_RST signal is de-asserted in synchronization with the CLK rising edge, there are three or four CLK cycles of systematic delay and the next CLK falling edge synchronizes the DCLK output with those of other ADC08D1020s in the system. The DCLK output is enabled again after a constant delay (relative to the input clock frequency) which is equal to the CLK input to DCLK output delay (t_{OD}). The device always exhibits this delay characteristic in normal operation. The user has the option of using a single-ended DCLK_RST signal, but a differential DCLK_RST is strongly recommended due to its superior timing specifications.

As shown in [Figure 7](#), [Figure 8](#), and [Figure 9](#) of the Timing Diagrams, there is a delay from the deassertion of DCLK_RST to the reappearance of DCLK, which is equal to several cycles of CLK plus t_{OD} . Note that the deassertion of DCLK_RST is not latched in until the next falling edge of CLK. For 1:2 Demux DDR 0° Mode, there are four CLK cycles of delay; for all other modes, there are three CLK cycles of delay.

If the device is not programmed to allow DCLK to run continuously, DCLK will become inactive during a calibration cycle. Therefore, it is strongly recommended that DCLK only be used as a data capture clock and not as a system clock.

The DCLK_RST pin should NOT be brought high while the calibration process is running (while CalRun is high). Doing so could cause a digital glitch in the digital circuitry, resulting in corruption and invalidation of the calibration.

1.6 ADC TEST PATTERN

To aid in system debug, the ADC08D1020 has the capability of providing a test pattern at the four output ports completely independent of the input signal. The ADC is disengaged and a test pattern generator is connected to the outputs including OR. The test pattern output is the same in DES mode and non-DES mode. Each port is given a unique 8-bit word, alternating between 1's and 0's as described in [Table 6](#) and [Table 7](#).

TABLE 6. Test Pattern by Output Port in 1:2 Demultiplex Mode

Time	Qd	Id	Q	I	OR	Comments
T0	01h	02h	03h	04h	0	Pattern Sequence n
T1	FEh	FDh	FCh	FBh	1	
T2	01h	02h	03h	04h	0	
T3	FEh	FDh	FCh	FBh	1	
T4	01h	02h	03h	04h	0	

Time	Qd	Id	Q	I	OR	Comments
T5	01h	02h	03h	04h	0	Pattern Sequence n+1
T6	FEh	FDh	FCh	FBh	1	
T7	01h	02h	03h	04h	0	
T8	FEh	FDh	FCh	FBh	1	
T9	01h	02h	03h	04h	0	
T10	01h	02h	03h	04h	0	Pattern Sequence n+2
T11	

With the part programmed into the non-demultiplex mode, the test pattern's order will be as described in [Table 7](#).

TABLE 7. Test Pattern by Output Port in Non-demultiplex Mode

Time	Q	I	OR	Comments
T0	01h	02h	0	Pattern Sequence n
T1	FEh	FDh	1	
T2	01h	02h	0	
T3	01h	02h	0	
T4	FEh	FDh	1	
T5	FEh	FDh	1	
T6	01h	02h	0	
T7	01h	02h	0	
T8	FEh	FDh	1	Pattern Sequence n+1
T9	01h	02h	0	
T10	01h	02h	0	
T11	FEh	FDh	1	
T12	01h	02h	0	
T13	01h	02h	0	
T14	FEh	FDh	1	
T15	

It is possible for the I and the Q channels' test patterns to be not synchronized. Either I and Id or Q and Qd patterns may be slipped by one DCLK.

To ensure that the test pattern starts synchronously in each port, set DCLK_RST while writing the Test Pattern Output bit in the Extended Configuration Register. The pattern appears at the data output ports when DCLK_RST is cleared low. The test pattern will work at speed and will work with the device in the SDR, DDR and the non-demultiplex output modes.

2.0 Applications Information

2.1 THE REFERENCE VOLTAGE

The voltage reference for the ADC08D1020 is derived from a 1.254V bandgap reference, a buffered version of which is made available at pin 31, V_{BG} , for user convenience.

This output has an output current capability of $\pm 100 \mu\text{A}$ and should be buffered if more current than this is required.

The internal bandgap-derived reference voltage has a nominal value of 650 mV or 870 mV, as determined by the FSR pin and described in [1.1.4 The Analog Inputs](#).

There is no provision for the use of an external reference voltage, but the full-scale input voltage can be adjusted through a Configuration Register in the Extended Control mode, as explained in [1.2 NORMAL/EXTENDED CONTROL](#).

Differential input signals up to the chosen full-scale level will be digitized to 8 bits. Signal excursions beyond the full-scale range will be clipped at the output. These large signal excursions will also activate the OR output for the time that the signal is out of range. See [2.2.2 Out Of Range \(OR\) Indication](#).

One extra feature of the V_{BG} pin is that it can be used to raise the common mode voltage level of the LVDS outputs. The output offset voltage (V_{OS}) is typically 800 mV when the V_{BG} pin is used as an output or left unconnected. To raise the LVDS offset voltage to a typical value of 1175 mV the V_{BG} pin can be connected directly to the supply rails.

2.2 THE ANALOG INPUT

The analog input is a differential one to which the signal source may be a.c. coupled or d.c. coupled. In the normal mode, the full-scale input range is selected using the FSR pin as specified in the Converter Electrical Characteristics. In the Extended Control mode, the full-scale input range is selected by programming the Full-Scale Voltage Adjust register through the Serial Interface. For best performance when adjusting the input full-scale range in the Extended Control, refer to [1.4 REGISTER DESCRIPTION](#) for guidelines on limiting the amount of adjustment

[Table 8](#) gives the input to output relationship with the FSR pin high when the normal (non-extended) mode is used. With the FSR pin grounded, the millivolt values in [Table 8](#) are reduced to 75% of the values indicated. In the Enhanced Control Mode, these values will be determined by the full scale range and offset settings in the Control Registers.

TABLE 8. Differential Input To Output Relationship (Non-Extended Control Mode, FSR High)

V_{IN+}	V_{IN-}	Output Code
$V_{CM} - 217.5 \text{ mV}$	$V_{CM} + 217.5 \text{ mV}$	0000 0000
$V_{CM} - 109 \text{ mV}$	$V_{CM} + 109 \text{ mV}$	0100 0000
V_{CM}	V_{CM}	0111 1111 / 1000 0000
$V_{CM} + 109 \text{ mV}$	$V_{CM} - 109 \text{ mV}$	1100 0000
$V_{CM} + 217.5 \text{ mV}$	$V_{CM} - 217.5 \text{ mV}$	1111 1111

The buffered analog inputs simplify the task of driving these inputs and the RC pole that is generally used at sampling ADC inputs is not required. If it is desired to use an amplifier circuit before the ADC, use care in choosing an amplifier with adequate noise and distortion performance and adequate gain at the frequencies used for the application.

Note that a precise d.c. common mode voltage must be present at the ADC inputs. This common mode voltage, V_{CMO} , is provided on-chip when a.c. input coupling is used and the input signal is a.c. coupled to the ADC.

When the inputs are a.c. coupled, the V_{CMO} output *must* be grounded, as shown in [Figure 12](#). This causes the on-chip V_{CMO} voltage to be connected to the inputs through on-chip 50 k Ω resistors.

IMPORTANT NOTE: An Analog input channel that is not used (e.g. in DES Mode) should be connected to ac-ground (ie, capacitors to ground) when the inputs are a.c. coupled. Do not connect an unused analog input directly to ground.

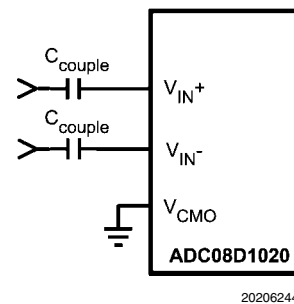

FIGURE 12. Differential Input Drive

When the d.c. coupled mode is used, a common mode voltage must be provided at the differential inputs. This common mode voltage should track the V_{CMO} output pin. Note that the V_{CMO} output potential will change with temperature. The common mode output of the driving device should track this change.

IMPORTANT NOTE: An analog input channel that is not used (e.g. in DES Mode) should be tied to the V_{CMO} voltage when the inputs are d.c. coupled. Do not connect unused analog inputs to ground.

Full-scale distortion performance falls off rapidly as the input common mode voltage deviates from V_{CMO} . This is a direct result of using a very low supply voltage to minimize power. Keep the input common mode voltage within 50 mV of V_{CMO} .

Performance is as good in the d.c. coupled mode as it is in the a.c. coupled mode, provided the input common mode voltage at both analog inputs remain within 50 mV of V_{CMO} .

2.2.1 Handling Single-Ended Input Signals

There is no provision for the ADC08D1020 to adequately process single-ended input signals. The best way to handle single-ended signals is to convert them to differential signals before presenting them to the ADC. The easiest way to accomplish single-ended to differential signal conversion is with an appropriate balun-connected transformer, as shown in [Figure 13](#).

2.2.1.1. a.c. Coupled Input

The easiest way to accomplish single-ended a.c. input to differential a.c. signal is by using an appropriate balun, as shown in [Figure 13](#).

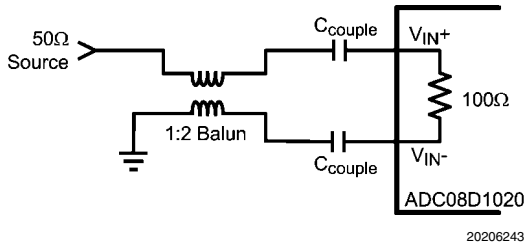

FIGURE 13. Single-Ended to Differential Signal Conversion Using a Balun

Figure 13 is a generic depiction of a single-ended to differential signal conversion using a balun. The circuitry specific to the balun will depend upon the type of balun selected and the overall board layout. It is recommended that the system designer contact the manufacturer of the balun they have selected to aid in designing the best performing single-ended to differential conversion circuit using that particular balun.

When selecting a balun, it is important to understand the input architecture of the ADC. There are specific balun parameters of which the system designer should be mindful. A designer should match the impedance of their analog source to the ADC08D1020's on-chip 100Ω differential input termination resistor. The range of this termination resistor is described in the electrical table as the specification R_{IN} .

Also, the phase and amplitude balance are important. The lowest possible phase and amplitude imbalance is desired

when selecting a balun. The phase imbalance should be no more than $\pm 2.5^\circ$ and the amplitude imbalance should be limited to less than 1dB at the desired input frequency range. Finally, when selecting a balun, the VSWR (Voltage Standing Wave Ratio), bandwidth and insertion loss of the balun should also be considered. The VSWR aids in determining the overall transmission line termination capability of the balun when interfacing to the ADC input. The insertion loss should be considered so that the signal at the balun output is within the specified input range of the ADC as described in the Converter Electrical Characteristics as the specification V_{IN} .

2.2.1.2. d.c. Coupled Input

When d.c. coupling to the ADC08D1020 analog inputs is required, single-ended to differential conversion may be easily accomplished with the LMH6555, as shown in Figure 14. In such applications, the LMH6555 performs the task of single-ended to differential conversion while delivering low distortion and noise, as well as output balance, that supports the operation of the ADC08D1020. Connecting the ADC08D1020 V_{CMO} pin to the V_{CM_REF} pin of the LMH6555, through an appropriate buffer, will ensure that the common mode input voltage is as needed for optimum performance of the ADC08D1020. The LMV321 was chosen to buffer V_{CMD} for its low voltage operation and reasonable offset voltage.

Be sure to limit output current from the ADC08D1020 V_{CMO} pin to 100 μ A

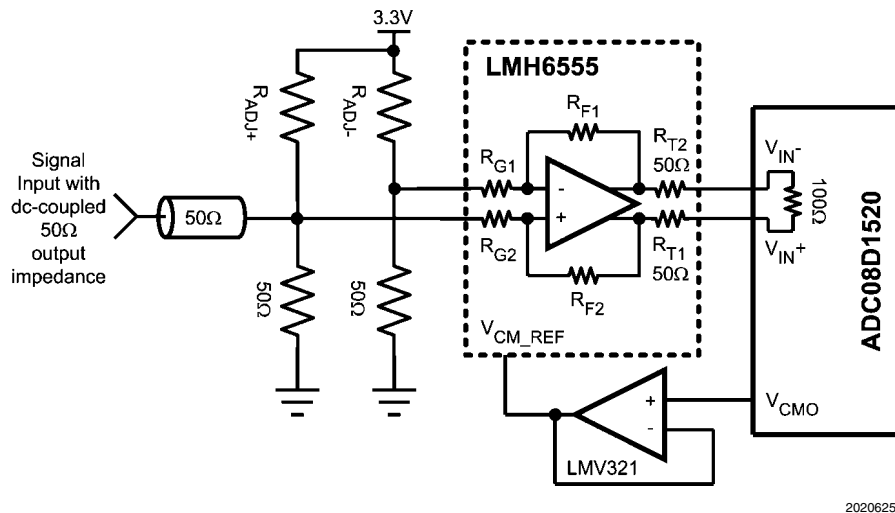

FIGURE 14. Example of Servoing the Analog Input with V_{CMO}

In Figure 14, R_{ADJ-} and R_{ADJ+} are used to adjust the differential offset that can be measured at the ADC inputs V_{IN+} / V_{IN-} with LMH6555's input terminated to ground as shown but not driven and with no R_{ADJ} resistors applied. An unadjusted positive offset with reference to V_{IN-} greater than 115mV should be reduced with a resistor in the R_{ADJ-} position. Likewise, an unadjusted negative offset with reference to V_{IN-} greater than 115mV should be reduced with a resistor in the R_{ADJ+} position. Table 9 gives suggested R_{ADJ-} and R_{ADJ+} values for various unadjusted differential offsets to bring the V_{IN+} / V_{IN-} offset back to within 115mV.

TABLE 9. D.C. Coupled Offset Adjustment

Unadjusted Offset Reading	Resistor Value
0mV to 10mV	no resistor needed
11mV to 30mV	20.0kΩ
31mV to 50mV	10.0kΩ
51mV to 70mV	6.81kΩ
71mV to 90mV	4.75kΩ
91mV to 110mV	3.92kΩ

2.2.2 Out Of Range (OR) Indication

When the conversion result is clipped the Out of Range output is activated such that OR+ goes high and OR- goes low. This output is active as long as accurate data on either or both of the buses would be outside the range of 00h to FFh. Note that when the device is programmed to provide a second DCLK output, the OR signals become DCLK2. Refer to [1.4 REGISTER DESCRIPTION](#)

2.2.3 Full-Scale Input Range

As with all A/D Converters, the input range is determined by the value of the ADC's reference voltage. The reference voltage of the ADC08D1020 is derived from an internal band-gap reference. The FSR pin controls the effective reference voltage of the ADC08D1020 such that the differential full-scale input range at the analog inputs is a normal amplitude with the FSR pin high, or a reduced amplitude with FSR pin low as defined by the specification V_{IN} in the Converter Electrical Characteristics. Best SNR is obtained with FSR high, but better distortion and SFDR are obtained with the FSR pin low. The LMH6555 of is [Figure 14](#) suitable for any Full Scale Range.

2.3 THE CLOCK INPUTS

The ADC08D1020 has differential LVDS clock inputs, CLK+ and CLK-, which must be driven with an a.c. coupled, differential clock signal. Although the ADC08D1020 is tested and its performance is guaranteed with a differential 1 GHz clock, it typically will function well with input clock frequencies indicated in the Converter Electrical Characteristics. The clock inputs are internally terminated and biased. The input clock signal must be capacitively coupled to the clock pins as indicated in [Figure 15](#).

Operation up to the sample rates indicated in the Converter Electrical Characteristics is typically possible if the maximum ambient temperatures indicated are not exceeded. Operating at higher sample rates than indicated for the given ambient temperature may result in reduced device reliability and product lifetime. This is because of the higher power consumption and die temperatures at high sample rates. Important also for reliability is proper thermal management. See [2.6.2 Thermal Management](#).

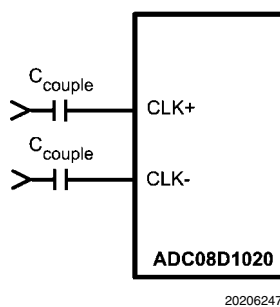

FIGURE 15. Differential (LVDS) Input Clock Connection

The differential input clock line pair should have a characteristic impedance of 100 Ω and (when using a balun), be terminated at the clock source in that (100 Ω) characteristic impedance. The input clock line should be as short and as direct as possible. The ADC08D1020 clock input is internally terminated with an untrimmed 100 Ω resistor.

Insufficient input clock levels will result in poor dynamic performance. Excessively high clock levels could cause a change in the analog input offset voltage. To avoid these

problems, keep the clock level within the range specified as V_{ID} in the Converter Electrical Characteristics.

The low and high times of the input clock signal can affect the performance of any A/D Converter. The ADC08D1020 features a duty cycle clock correction circuit which can maintain performance over temperature even in DES mode. The ADC will meet its performance specification if the input clock high and low times are maintained within the duty cycle range as specified in the Converter Electrical Characteristics.

High speed, high performance ADCs such as the ADC08D1020 require a very stable input clock signal with minimum phase noise or jitter. ADC jitter requirements are defined by the ADC resolution (number of bits), maximum ADC input frequency and the input signal amplitude relative to the ADC input full scale range. The maximum jitter (the sum of the jitter from all sources) allowed to prevent a jitter-induced reduction in SNR is found to be

$$t_{J(MAX)} = (V_{INFSR} / V_{IN(P-P)}) \times (1 / (2^{(N+1)} \times \pi \times f_{IN}))$$

where $t_{J(MAX)}$ is the rms total of all jitter sources in seconds, $V_{IN(P-P)}$ is the peak-to-peak analog input signal, V_{INFSR} is the full-scale range of the ADC, "N" is the ADC resolution in bits and f_{IN} is the maximum input frequency, in Hertz, at the ADC analog input.

Note that the maximum jitter described above is the RSS sum of the jitter from all sources, including that in the ADC input clock, that added by the system to the ADC input clock and input signals and that added by the ADC itself. Since the effective jitter added by the ADC is beyond user control, the best the user can do is to keep the sum of the externally added input clock jitter and the jitter added by the analog circuitry to the analog signal to a minimum.

Input clock amplitudes above those specified in the Converter Electrical Characteristics may result in increased input offset voltage. This would cause the converter to produce an output code other than the expected 127/128 when both input pins are at the same potential.

2.4 CONTROL PINS

Six control pins (without the use of the serial interface) provide a wide range of possibilities in the operation of the ADC08D1020 and facilitate its use. These control pins provide Full-Scale Input Range setting, Calibration, Calibration Delay, Output Edge Synchronization choice, LVDS Output Level choice and a Power Down feature.

2.4.1 Full-Scale Input Range Setting

The input full-scale range can be selected with the FSR control input (pin 14) in the normal mode of operation. The input full-scale range is specified as V_{IN} in the Converter Electrical Characteristics. In the extended control mode, the input full-scale range may be programmed using the Full-Scale Adjust Voltage register. See [2.2 THE ANALOG INPUT](#) for more information.

2.4.2 Calibration

The ADC08D1020 calibration must be run to achieve specified performance. The calibration procedure is run upon power-up and can be run any time on command. The calibration procedure is exactly the same whether there is an input clock present upon power up or if the clock begins some time after application of power. The CalRun output indicator is high while a calibration is in progress. Note that the DCLK outputs are not active during a calibration cycle by default and therefore are not recommended as system clock unless the Resistor Trim Disable feature is used (Reg.9h). The DCLK

outputs are continuously present at the output only when the Resistor Trim Disable is active.

2.4.2.1 Power-On Calibration

Power-on calibration begins after a time delay following the application of power. This time delay is determined by the setting of CalDly, as described in the Calibration Delay Section, below.

The calibration process will not be performed if the CAL pin is high at power up. In this case, the calibration cycle will not begin until the on-command calibration conditions are met. The ADC08D1020 will function with the CAL pin held high at power up, but no calibration will be done and performance will be impaired. A manual calibration, however, may be performed after powering up with the CAL pin high. See On-Command Calibration [2.4.2.2 On-Command Calibration](#).

The internal power-on calibration circuitry comes up in an unknown logic state. If the input clock is not running at power up and the power on calibration circuitry is active, it will hold the analog circuitry in power down and the power consumption will typically be less than 200 mW. The power consumption will be normal after the clock starts.

2.4.2.2 On-Command Calibration

To initiate an on-command calibration, bring the CAL pin high for a minimum of $t_{\text{CAL_H}}$ input clock cycles after it has been low for a minimum of $t_{\text{CAL_L}}$ input clock cycles. Holding the CAL pin high upon power up will prevent execution of power-on calibration until the CAL pin is low for a minimum of $t_{\text{CAL_L}}$ input clock cycles, then brought high for a minimum of another $t_{\text{CAL_H}}$ input clock cycles. The calibration cycle will begin $t_{\text{CAL_H}}$ input clock cycles after the CAL pin is thus brought high. The CalRun signal should be monitored to determine when the calibration cycle has completed.

The minimum $t_{\text{CAL_L}}$ and $t_{\text{CAL_H}}$ input clock cycle sequence is required to ensure that random noise does not cause a calibration to begin when it is not desired. As mentioned for best performance, a calibration should be performed 20 seconds or more after power up and repeated when the operating temperature changes significantly relative to the specific system design performance requirements.

By default, On-Command calibration also includes calibrating the input termination resistance and the ADC. However, since the input termination resistance, once trimmed at power-up, changes marginally with temperature, the user has the option to disable the input termination resistor trim, which will guarantee that the DCLK is continuously present at the output during subsequent calibration. The Resistor Trim Disable can be programmed in register (address: 1h, bit 13) when in the Extended Control mode. Refer to for register programming information.

2.4.2.3 Calibration Delay

The CalDly input (pin 127) is used to select one of two delay times after the application of power to the start of calibration, as described in [1.1.1 Calibration](#). The calibration delay values allow the power supply to come up and stabilize before calibration takes place. With no delay or insufficient delay, calibration would begin before the power supply is stabilized at its operating value and result in non-optimal calibration coefficients. If the PD pin is high upon power-up, the calibration delay counter will be disabled until the PD pin is brought low. Therefore, holding the PD pin high during power up will further delay the start of the power-up calibration cycle. The best setting of the CalDly pin depends upon the power-on settling time of the power supply.

Note that the calibration delay selection is not possible in the Extended Control mode and the short delay time is used.

2.4.3 Output Edge Synchronization

DCLK signals are available to help latch the converter output data into external circuitry. The output data can be synchronized with either edge of these DCLK signals. That is, the output data transition can be set to occur with either the rising edge or the falling edge of the DCLK signal, so that either edge of that DCLK signal can be used to latch the output data into the receiving circuit.

When OutEdge (pin 4) is high, the output data is synchronized with (changes with) the rising edge of the DCLK+ (pin 82). When OutEdge is low, the output data is synchronized with the falling edge of DCLK+.

At the very high speeds of which the ADC08D1020 is capable, slight differences in the lengths of the DCLK and data lines can mean the difference between successful and erroneous data capture. The OutEdge pin is used to capture data on the DCLK edge that best suits the application circuit and layout. Reliable data capture can be achieved by using just one DCLK+/- signal for the full 32 signal data bus. However, if desired, the user may configure the OR+/- output as the second DCLK+/- output instead.

2.4.4 LVDS Output Level Control

The output level can be set to one of two levels with OutV (pin 3). The strength of the output drivers is greater with OutV high. With OutV low there is less power consumption in the output drivers, but the lower output level means decreased noise immunity.

For short LVDS lines and low noise systems, satisfactory performance may be realized with the OutV input low. If the LVDS lines are long and/or the system in which the ADC08D1020 is used is noisy, it may be necessary to tie the OutV pin high.

2.4.5 Dual Edge Sampling

The Dual Edge Sampling (DES) feature causes one of the two input pairs to be routed to both ADCs. The other input pair is deactivated. One of the ADCs samples the input signal on one input clock edge (duty cycle corrected), the other samples the input signal on the other input clock edge (duty cycle corrected). If the device is in the 1:2 output demultiplex mode, the result is an output data rate 1/4 that of the interleaved sample rate which is twice the input clock frequency. Data is presented in parallel on all four output buses in the following order: DQd, Did, DQ, DI. If the device is the non-demultiplex output mode, the result is an output data rate 1/2 that of the interleaved sample rate. Data is presented in parallel on two output buses in the following order: DQ, DI.

To use this feature in the non-extended control mode, allow pin 127 to float and the signal at the "I" channel input will be sampled by both converters. The Calibration Delay will then only be a short delay.

In the extended control mode, either input may be used for dual edge sampling. See [1.1.5.1 Dual-Edge Sampling](#).

2.4.6 Power Down Feature

The Power Down pins (PD and PDQ) allow the ADC08D1020 to be entirely powered down (PD) or the "Q" channel to be powered down and the "I" channel to remain active. See [1.1.7 Power Down](#) for details on the power down feature.

The digital data (+/-) output pins are put into a high impedance state when the PD pin for the respective channel is high. Upon return to normal operation, the pipeline will contain meaningless information and must be flushed.

If the PD input is brought high while a calibration is running, the device will not go into power down until the calibration sequence is complete. However, if power is applied and PD is already high, the device will not begin the calibration sequence until the PD input goes low. If a manual calibration is requested while the device is powered down, the calibration will not begin at all. That is, the manual calibration input is completely ignored in the power down state.

2.5 THE DIGITAL OUTPUTS

The ADC08D1020 normally demultiplexes the output data of each of the two ADCs on the die onto two LVDS output buses (total of four buses, two for each ADC). For each of the two converters, the results of successive conversions started on the odd falling edges of the CLK+ pin are available on one of the two LVDS buses, while the results of conversions started on the even falling edges of the CLK+ pin are available on the other LVDS bus. This means that, the word rate at each LVDS bus is 1/2 the ADC08D1020 input clock rate and the two buses must be multiplexed to obtain the entire 1 GSPS conversion result.

Since the minimum recommended input clock rate for this device is 200 MSPS (normal non-DES mode), the effective rate can be reduced to as low as 100 MSPS by using the results available on just one of the two LVDS buses and a 200 MHz input clock, decimating the 200 MSPS data by two.

There is one LVDS output clock pair (DCLK+/-) available for use to latch the LVDS outputs on all buses. However, the user has the option to configure the OR+/- output as a second DCLK+/- pair. Whether the data is sent at the rising or falling edge of DCLK is determined by the sense of the OutEdge pin, as described in [2.4.3 Output Edge Synchronization](#).

DDR (Double Data Rate) clocking can also be used. In this mode a word of data is presented with each edge of DCLK, reducing the DCLK frequency to 1/4 the input clock frequency. See the Timing Diagram section for details.

The OutV pin is used to set the LVDS differential output levels. See [2.4.4 LVDS Output Level Control](#).

The output format is Offset Binary. Accordingly, a full-scale input level with V_{IN+} positive with respect to V_{IN-} will produce an output code of all ones, a full-scale input level with V_{IN-} positive with respect to V_{IN+} will produce an output code of all zeros and when V_{IN+} and V_{IN-} are equal, the output code will vary between codes 127 and 128. A non-multiplexed mode of operation is available for those cases where the digital ASIC is capable of higher speed operation.

2.6 POWER CONSIDERATIONS

A/D converters draw sufficient transient current to corrupt their own power supplies if not adequately bypassed. A 33 μF capacitor should be placed within an inch (2.5 cm) of the A/D converter power pins. A 0.1 μF capacitor should be placed as close as possible to each V_A pin, preferably within one-half centimeter. Leadless chip capacitors are preferred because they have low lead inductance.

The V_A and V_{DR} supply pins should be isolated from each other to prevent any digital noise from being coupled into the analog portions of the ADC. A ferrite choke, such as the JW Miller FB20009-3B, is recommended between these supply lines when a common source is used for them.

As is the case with all high speed converters, the ADC08D1020 should be assumed to have little power supply noise rejection. Any power supply used for digital circuitry in a system where a lot of digital power is being consumed should not be used to supply power to the ADC08D1020. The

ADC supplies should be the same supply used for other analog circuitry, if not a dedicated supply.

2.6.1 Supply Voltage

The ADC08D1020 is specified to operate with a supply voltage of $1.9\text{V} \pm 0.1\text{V}$. It is very important to note that, while this device will function with slightly higher supply voltages, these higher supply voltages may reduce product lifetime.

No pin should ever have a voltage on it that is in excess of the supply voltage or below ground by more than 150 mV, not even on a transient basis. This can be a problem upon application of power and power shut-down. Be sure that the supplies to circuits driving any of the input pins, analog or digital, do not come up any faster than does the voltage at the ADC08D1020 power pins.

The Absolute Maximum Ratings should be strictly observed, even during power up and power down. A power supply that produces a voltage spike at turn-on and/or turn-off of power can destroy the ADC08D1020. The circuit of [Figure 16](#) will provide supply overshoot protection.

Many linear regulators will produce output spiking at power-on unless there is a minimum load provided. Active devices draw very little current until their supply voltages reach a few hundred millivolts. The result can be a turn-on spike that can destroy the ADC08D1020, unless a minimum load is provided for the supply. The 100 Ω resistor at the regulator output provides a minimum output current during power-up to ensure there is no turn-on spiking.

In the circuit of [Figure 16](#), an LM317 linear regulator is satisfactory if its input supply voltage is 4V to 5V. If a 3.3V supply is used, an LM1086 linear regulator is recommended.

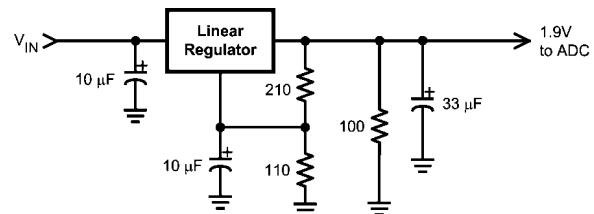

20206254

FIGURE 16. Non-Spiking Power Supply

The output drivers should have a supply voltage, V_{DR} , that is within the range specified in the Operating Ratings table. This voltage should not exceed the V_A supply voltage.

If the power is applied to the device without an input clock signal present, the current drawn by the device might be below 200 mA. This is because the ADC08D1020 gets reset through clocked logic and its initial state is unknown. If the reset logic comes up in the "on" state, it will cause most of the analog circuitry to be powered down, resulting in less than 100 mA of current draw. This current is greater than the power down current because not all of the ADC is powered down. The device current will be normal after the input clock is established.

2.6.2 Thermal Management

The ADC08D1020 is capable of impressive speeds and performance at very low power levels for its speed. However, the power consumption is still high enough to require attention to thermal management. For reliability reasons, the die temperature should be kept to a maximum of 130°C. That is, T_A (ambient temperature) plus ADC power consumption times θ_{JA} (junction to ambient thermal resistance) should not ex-

ceed 130°C. This is not a problem if the ambient temperature is kept to a maximum of +85°C as specified in the Operating Ratings section.

Please note that the following are general recommendations for mounting exposed pad devices onto a PCB. This should be considered the starting point in PCB and assembly process development. It is recommended that the process be developed based upon past experience in package mounting.

The package of the ADC08D1020 has an exposed pad on its back that provides the primary heat removal path as well as excellent electrical grounding to the printed circuit board. The land pattern design for lead attachment to the PCB should be the same as for a conventional LQFP, but the exposed pad must be attached to the board to remove the maximum amount of heat from the package, as well as to ensure best product parametric performance.

To maximize the removal of heat from the package, a thermal land pattern must be incorporated on the PC board within the footprint of the package. The exposed pad of the device must be soldered down to ensure adequate heat conduction out of the package. The land pattern for this exposed pad should be at least as large as the 5 x 5 mm of the exposed pad of the package and be located such that the exposed pad of the device is entirely over that thermal land pattern. This thermal land pattern should be electrically connected to ground. A clearance of at least 0.5 mm should separate this land pattern from the mounting pads for the package pins.

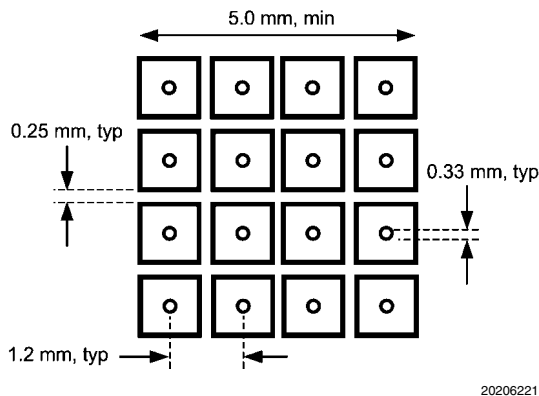

FIGURE 17. Recommended Package Land Pattern

Since a large aperture opening may result in poor release, the aperture opening should be subdivided into an array of smaller openings, similar to the land pattern of [Figure 17](#).

To minimize junction temperature, it is recommended that a simple heat sink be built into the PCB. This is done by including a copper area of about 2 square inches (6.5 square cm) on the opposite side of the PCB. This copper area may be plated or solder coated to prevent corrosion, but should not have a conformal coating, which could provide some thermal insulation. Thermal vias should be used to connect these top and bottom copper areas. These thermal vias act as "heat pipes" to carry the thermal energy from the device side of the board to the opposite side of the board where it can be more effectively dissipated. The use of 9 to 16 thermal vias is recommended.

The thermal vias should be placed on a 1.2 mm grid spacing and have a diameter of 0.30 to 0.33 mm. These vias should be barrel plated to avoid solder wicking into the vias during the soldering process as this wicking could cause voids in the solder between the package exposed pad and the thermal

land on the PCB. Such voids could increase the thermal resistance between the device and the thermal land on the board, which would cause the device to run hotter.

If it is desired to monitor die temperature, a temperature sensor may be mounted on the heat sink area of the board near the thermal vias. Allow for a thermal gradient between the temperature sensor and the ADC08D1020 die of θ_{JC} (Thermal Pad) times typical power consumption = $2.8 \times 1.8 = 5^\circ\text{C}$. Allowing for 6°C , including some margin for temperature drop from the pad to the temperature sensor, then, would mean that maintaining a maximum pad temperature reading of 124°C will ensure that the die temperature does not exceed 130°C , assuming that the exposed pad of the ADC08D1020 is properly soldered down and the thermal vias are adequate. (The inaccuracy of the temperature sensor is in addition to the above calculation).

2.7 LAYOUT AND GROUNDING

Proper grounding and proper routing of all signals are essential to ensure accurate conversion. A single ground plane should be used, instead of splitting the ground plane into analog and digital areas.

Since digital switching transients are composed largely of high frequency components, the skin effect tells us that total ground plane copper weight will have little effect upon the logic-generated noise. Total surface area is more important than is total ground plane volume. Coupling between the typically noisy digital circuitry and the sensitive analog circuitry can lead to poor performance that may seem impossible to isolate and remedy. The solution is to keep the analog circuitry well separated from the digital circuitry.

High power digital components should not be located on or near any linear component or power supply trace or plane that services analog or mixed signal components as the resulting common return current path could cause fluctuation in the analog input "ground" return of the ADC, causing excessive noise in the conversion result.

Generally, we assume that analog and digital lines should cross each other at 90° to avoid getting digital noise into the analog path. In high frequency systems, however, avoid crossing analog and digital lines altogether. The input clock lines should be isolated from ALL other lines, analog AND digital. The generally-accepted 90° crossing should be avoided as even a little coupling can cause problems at high frequencies. Best performance at high frequencies is obtained with a straight signal path.

The analog input should be isolated from noisy signal traces to avoid coupling of spurious signals into the input. This is especially important with the low level drive required of the ADC08D1020. Any external component (e.g., a filter capacitor) connected between the converter's input and ground should be connected to a very clean point in the analog ground plane. All analog circuitry (input amplifiers, filters, etc.) should be separated from any digital components.

2.8 DYNAMIC PERFORMANCE

The ADC08D1020 is a.c. tested and its dynamic performance is guaranteed. To meet the published specifications and avoid jitter-induced noise, the clock source driving the CLK input must exhibit low rms jitter. The allowable jitter is a function of the input frequency and the input signal level, as described in [2.3 THE CLOCK INPUTS](#).

It is good practice to keep the ADC input clock line as short as possible, to keep it well away from any other signals and to treat it as a transmission line. Other signals can introduce jitter into the input clock signal. The clock signal can also in-

roduce noise into the analog path if not isolated from that path.

Best dynamic performance is obtained when the exposed pad at the back of the package has a good connection to ground. This is because this path from the die to ground is a lower impedance than offered by the package pins.

2.9 USING THE SERIAL INTERFACE

The ADC08D1020 may be operated in the non-extended control (non-Serial Interface) mode or in the extended control mode. [Table 10](#) and [Table 11](#) describe the functions of pins 3, 4, 14 and 127 in the non-extended control mode and the extended control mode, respectively.

2.9.1 Non-Extended Control Mode Operation

Non-extended control mode operation means that the Serial Interface is not active and all controllable functions are controlled with various pin settings. Pin 41 is the primary control of the extended control enable function. When pin 41 is logic high, the device is in the non-extended control mode. If pin 41 is floating and pin 52 is floating or logic high, the extended control enable function is controlled by pin 14. The device has functions which are pin programmable when in the non-extended control mode. An example is the full-scale range is controlled in the non-extended control mode by setting pin 14 high or low. [Table 10](#) indicates the pin functions of the ADC08D1020 in the non-extended control mode.

TABLE 10. Non-Extended Control Mode Operation (Pin 41 Floating and Pin 52 Floating or Logic High)

Pin	Low	High	Floating
3	Reduced V_{OD}	Normal V_{OD}	n/a
4	OutEdge = Neg	OutEdge = Pos	DDR
127	CalDly Short	CalDly Long	DES
14	Reduced V_{IN}	Normal V_{IN}	Extended Control Mode

Pin 3 can be either high or low in the non-extended control mode. See [1.2 NORMAL/EXTENDED CONTROL](#) for more information.

Pin 4 can be high or low or can be left floating in the non-extended control mode. In the non-extended control mode, pin 4 high or low defines the edge at which the output data transitions. See [2.4.3 Output Edge Synchronization](#) for more information. If this pin is floating, the output clock (DCLK) is a DDR (Double Data Rate) clock (see [1.1.5.3 Single Data Rate and Double Data Rate](#)) and the output edge synchronization is irrelevant since data is clocked out on both DCLK edges.

Pin 127, if it is high or low in the non-extended control mode, sets the calibration delay. If pin 127 is floating, the calibration delay is the same as it would be with this pin low and the converter performs dual edge sampling (DES).

TABLE 11. Extended Control Mode Operation (Pin 41 Logic Low or Pin 14 Floating and Pin 52 Floating or Logic High)

Pin	Function
3	SCLK (Serial Clock)
4	SDATA (Serial Data)
127	SCS (Serial Interface Chip Select)

2.10 COMMON APPLICATION PITFALLS

Failure to write all register locations when using extended control mode. When using the serial interface, all nine address locations must be written at least once with the default or desired values before calibration and subsequent use of the ADC.

Driving the inputs (analog or digital) beyond the power supply rails. For device reliability, no input should go more than 150 mV below the ground pins or 150 mV above the supply pins. Exceeding these limits on even a transient basis may not only cause faulty or erratic operation, but may impair device reliability. It is not uncommon for high speed digital circuits to exhibit undershoot that goes more than a volt below ground. Controlling the impedance of high speed lines and terminating these lines in their characteristic impedance should control overshoot.

Care should be taken not to overdrive the inputs of the ADC08D1020. Such practice may lead to conversion inaccuracies and even to device damage.

Incorrect analog input common mode voltage in the d.c. coupled mode. As discussed in [1.1.4 The Analog Inputs](#) and [2.2 THE ANALOG INPUT](#), the Input common mode voltage must remain within 50 mV of the V_{CMO} output, which has a variability with temperature that must also be tracked. Distortion performance will be degraded if the input common mode voltage is more than 50 mV from V_{CMO} .

Using an inadequate amplifier to drive the analog input. Use care when choosing a high frequency amplifier to drive the ADC08D1020 as many high speed amplifiers will have higher distortion than will the ADC08D1020, resulting in overall system performance degradation.

Driving the V_{BG} pin to change the reference voltage. As mentioned in [2.1 THE REFERENCE VOLTAGE](#), the reference voltage is intended to be fixed by FSR pin or Full-Scale Voltage Adjust register settings. Over driving this pin will not change the full scale value, but can otherwise upset operation.

Driving the clock input with an excessively high level signal. The ADC input clock level should not exceed the level described in the Operating Ratings Table or the input offset could change.

Inadequate input clock levels. As described in [2.3 THE CLOCK INPUTS](#), insufficient input clock levels can result in poor performance. Excessive input clock levels could result in the introduction of an input offset.

Using a clock source with excessive jitter, using an excessively long input clock signal trace, or having other signals coupled to the input clock signal trace. This will cause the sampling interval to vary, causing excessive output noise and a reduction in SNR performance.

Failure to provide adequate heat removal. As described in [2.6.2 Thermal Management](#), it is important to provide adequate heat removal to ensure device reliability. This can be done either with adequate air flow or the use of a simple heat sink built into the board. The backside pad should be grounded for best performance.

Physical Dimensions inches (millimeters) unless otherwise noted

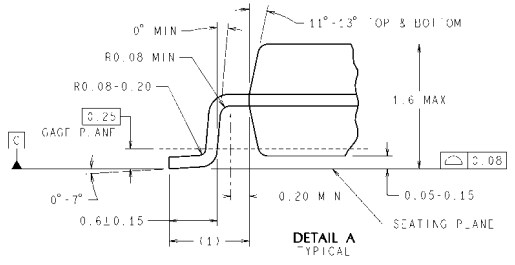
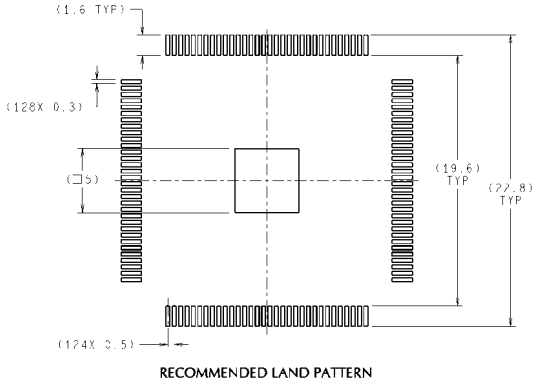
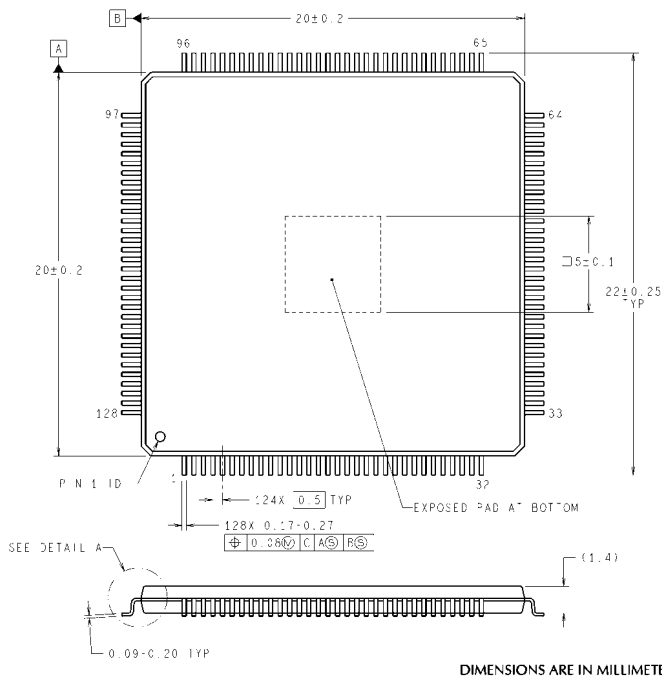

DIMENSIONS ARE IN MILLIMETERS

VNX128A (Rev B)

NOTES: UNLESS OTHERWISE SPECIFIED
 REFERENCE JEDEC REGISTRATION MS-026, VARIATION BFB.

128-Lead, Exposed Pad, Low Profile, Quad, Flatpack (LQFP)
Order Number ADC08D1020CIYB
NS Package Number VNX128A

Notes

ADC08D1020

Notes

For more National Semiconductor product information and proven design tools, visit the following Web sites at:

Products		Design Support	
Amplifiers	www.national.com/amplifiers	WEBENCH® Tools	www.national.com/webench
Audio	www.national.com/audio	App Notes	www.national.com/appnotes
Clock and Timing	www.national.com/timing	Reference Designs	www.national.com/refdesigns
Data Converters	www.national.com/adc	Samples	www.national.com/samples
Interface	www.national.com/interface	Eval Boards	www.national.com/evalboards
LVDS	www.national.com/lvds	Packaging	www.national.com/packaging
Power Management	www.national.com/power	Green Compliance	www.national.com/quality/green
Switching Regulators	www.national.com/switchers	Distributors	www.national.com/contacts
LDOs	www.national.com/lido	Quality and Reliability	www.national.com/quality
LED Lighting	www.national.com/led	Feedback/Support	www.national.com/feedback
Voltage Reference	www.national.com/vref	Design Made Easy	www.national.com/easy
PowerWise® Solutions	www.national.com/powerwise	Solutions	www.national.com/solutions
Serial Digital Interface (SDI)	www.national.com/sdi	Mil/Aero	www.national.com/milaero
Temperature Sensors	www.national.com/tempensors	SolarMagic™	www.national.com/solarmagic
Wireless (PLL/VCO)	www.national.com/wireless	PowerWise® Design University	www.national.com/training

THE CONTENTS OF THIS DOCUMENT ARE PROVIDED IN CONNECTION WITH NATIONAL SEMICONDUCTOR CORPORATION ("NATIONAL") PRODUCTS. NATIONAL MAKES NO REPRESENTATIONS OR WARRANTIES WITH RESPECT TO THE ACCURACY OR COMPLETENESS OF THE CONTENTS OF THIS PUBLICATION AND RESERVES THE RIGHT TO MAKE CHANGES TO SPECIFICATIONS AND PRODUCT DESCRIPTIONS AT ANY TIME WITHOUT NOTICE. NO LICENSE, WHETHER EXPRESS, IMPLIED, ARISING BY ESTOPPEL OR OTHERWISE, TO ANY INTELLECTUAL PROPERTY RIGHTS IS GRANTED BY THIS DOCUMENT.

TESTING AND OTHER QUALITY CONTROLS ARE USED TO THE EXTENT NATIONAL DEEMS NECESSARY TO SUPPORT NATIONAL'S PRODUCT WARRANTY. EXCEPT WHERE MANDATED BY GOVERNMENT REQUIREMENTS, TESTING OF ALL PARAMETERS OF EACH PRODUCT IS NOT NECESSARILY PERFORMED. NATIONAL ASSUMES NO LIABILITY FOR APPLICATIONS ASSISTANCE OR BUYER PRODUCT DESIGN. BUYERS ARE RESPONSIBLE FOR THEIR PRODUCTS AND APPLICATIONS USING NATIONAL COMPONENTS. PRIOR TO USING OR DISTRIBUTING ANY PRODUCTS THAT INCLUDE NATIONAL COMPONENTS, BUYERS SHOULD PROVIDE ADEQUATE DESIGN, TESTING AND OPERATING SAFEGUARDS.

EXCEPT AS PROVIDED IN NATIONAL'S TERMS AND CONDITIONS OF SALE FOR SUCH PRODUCTS, NATIONAL ASSUMES NO LIABILITY WHATSOEVER, AND NATIONAL DISCLAIMS ANY EXPRESS OR IMPLIED WARRANTY RELATING TO THE SALE AND/OR USE OF NATIONAL PRODUCTS INCLUDING LIABILITY OR WARRANTIES RELATING TO FITNESS FOR A PARTICULAR PURPOSE, MERCHANTABILITY, OR INFRINGEMENT OF ANY PATENT, COPYRIGHT OR OTHER INTELLECTUAL PROPERTY RIGHT.

LIFE SUPPORT POLICY

NATIONAL'S PRODUCTS ARE NOT AUTHORIZED FOR USE AS CRITICAL COMPONENTS IN LIFE SUPPORT DEVICES OR SYSTEMS WITHOUT THE EXPRESS PRIOR WRITTEN APPROVAL OF THE CHIEF EXECUTIVE OFFICER AND GENERAL COUNSEL OF NATIONAL SEMICONDUCTOR CORPORATION. As used herein:

Life support devices or systems are devices which (a) are intended for surgical implant into the body, or (b) support or sustain life and whose failure to perform when properly used in accordance with instructions for use provided in the labeling can be reasonably expected to result in a significant injury to the user. A critical component is any component in a life support device or system whose failure to perform can be reasonably expected to cause the failure of the life support device or system or to affect its safety or effectiveness.

National Semiconductor and the National Semiconductor logo are registered trademarks of National Semiconductor Corporation. All other brand or product names may be trademarks or registered trademarks of their respective holders.

Copyright© 2009 National Semiconductor Corporation

For the most current product information visit us at www.national.com



National Semiconductor Americas Technical Support Center
 Email: support@nsc.com
 Tel: 1-800-272-9959

National Semiconductor Europe Technical Support Center
 Email: europe.support@nsc.com

National Semiconductor Asia Pacific Technical Support Center
 Email: ap.support@nsc.com

National Semiconductor Japan Technical Support Center
 Email: jpn.feedback@nsc.com