

Features

- Yellow colored diffusion transparency lens type
- $\phi 5\text{mm}$ (T-1 $\frac{3}{4}$) all plastic mold type
- Low power consumption

Outline Dimensions

unit : mm

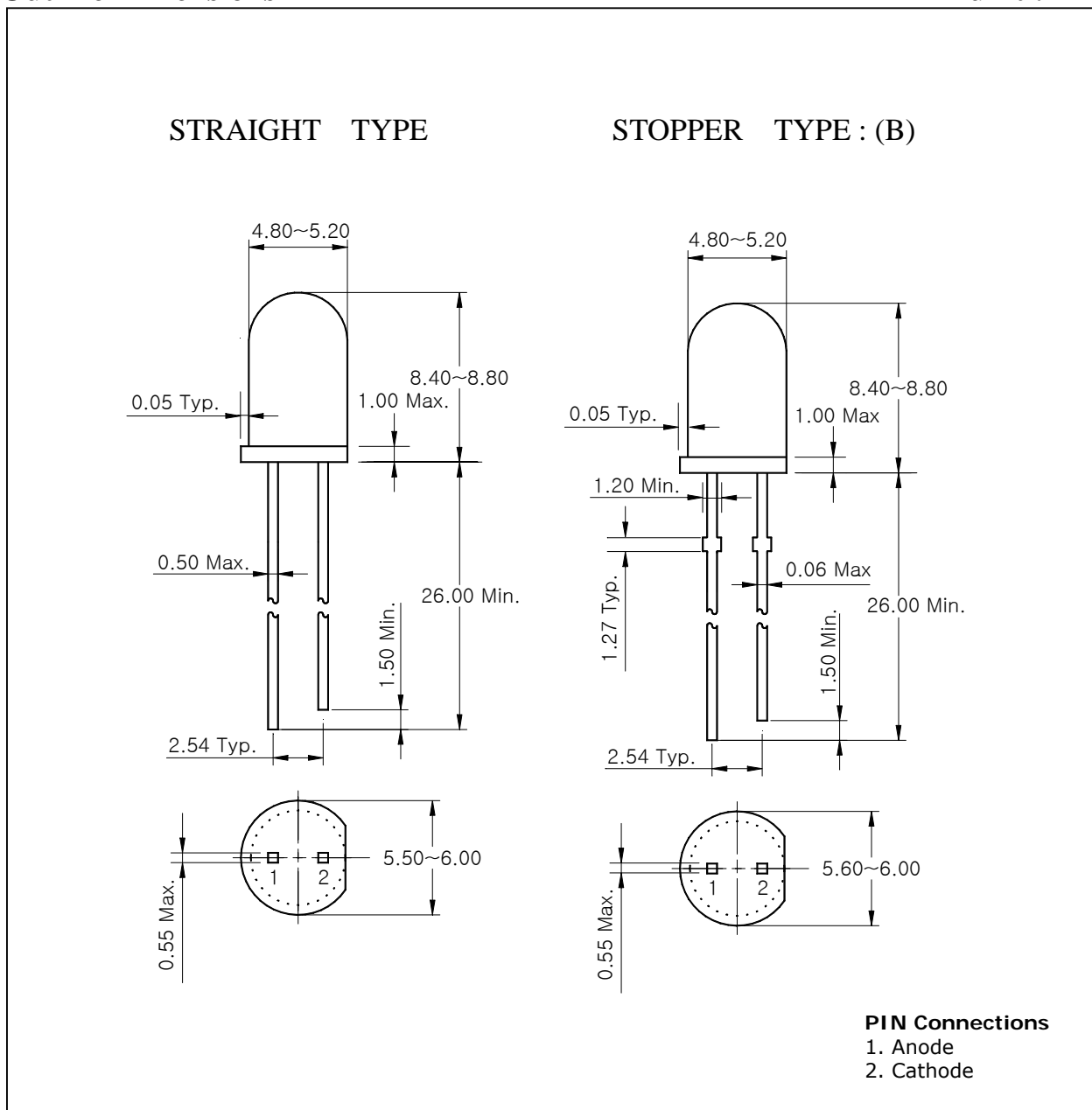

Absolute Maximum Ratings

(Ta=25°C)

Characteristic	Symbol	Rating	Unit
Power dissipation	P _D	75	mW
Forward current	I _F	30	mA
*1Peak forward current	I _{FP}	50	mA
Reverse voltage	V _R	4	V
Operating temperature range	T _{opr}	-25~85	°C
Storage temperature range	T _{stg}	-30~100	°C
*2Soldering temperature	T _{sol}	260°C for 10 seconds	

*1.Duty ratio = 1/16, Pulse width = 0.1ms

*2.Keep the distance more than 2.0mm from PCB to the bottom of LED package

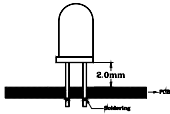

Electrical / Optical Characteristics

(Ta=25°C)

Characteristic	Symbol	Test Condition	Min.	Typ.	Max.	Unit
Forward voltage	V _F	I _F = 20mA	-	2.1	2.5	V
Radiant intensity	I _E	I _F = 20mA	27	-	100	mcd
Peak wavelength	λ _p	I _F = 20mA	-	585	-	nm
Spectrum bandwidth	Δλ	I _F = 20mA	-	30	-	nm
Reverse current	I _R	V _R =4V	-	-	10	uA
*3Half angle	θ ^{1/2}	I _F = 20mA	-	±20	-	deg

*3. θ^{1/2} is the off-axis angle where the luminous intensity is 1/2 the peak intensity

*4. Luminous intensity maximum tolerance for each grade classification limit is ±18%

*4. Luminous Intensity Classification

I	J	K
27 ~ 43	43 ~ 68	68 ~ 100

Characteristic Diagrams

Fig. 1 $I_F - V_F$

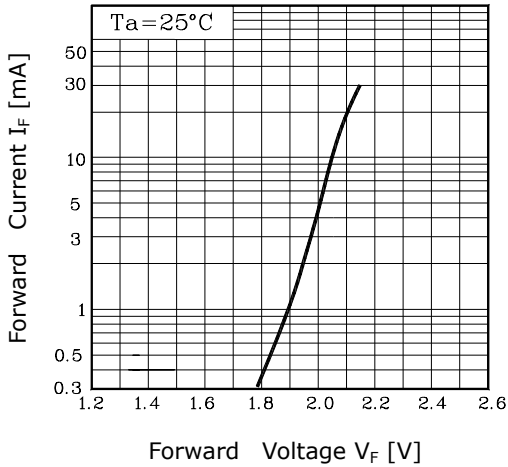

Fig. 2 $I_V - I_F$

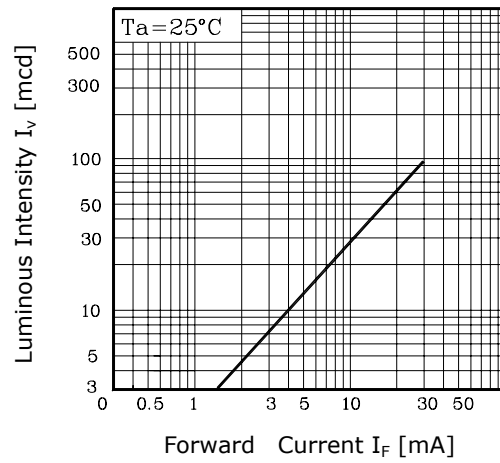

Fig. 3 $I_F - T_a$

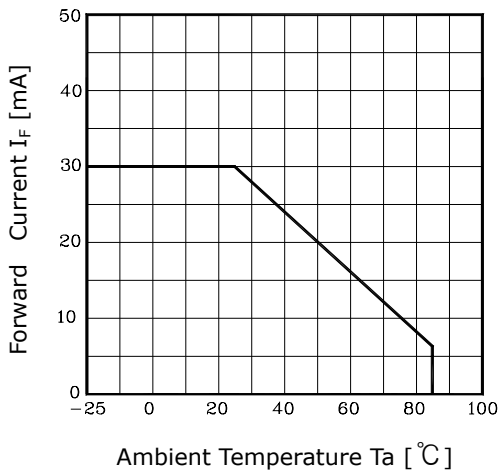

Fig.4 Spectrum Distribution

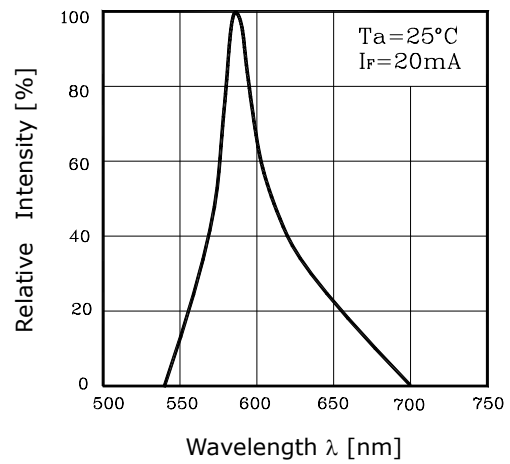
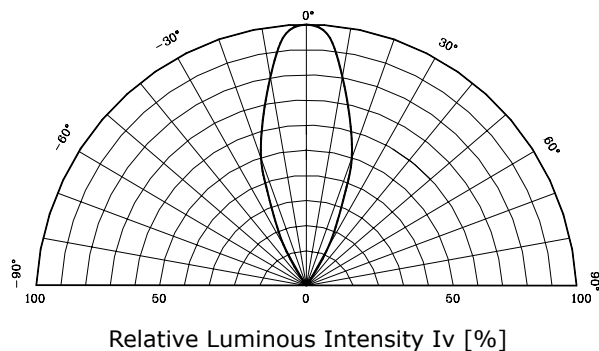

Fig. 5 Radiation Diagram



The AUK Corp. products are intended for the use as components in general electronic equipment (Office and communication equipment, measuring equipment, home appliance, etc.).

Please make sure that you consult with us before you use these AUK Corp. products in equipments which require high quality and / or reliability, and in equipments which could have major impact to the welfare of human life(atomic energy control, airplane, spaceship, transportation, combustion control, all types of safety device, etc.). AUK Corp. cannot accept liability to any damage which may occur in case these AUK Corp. products were used in the mentioned equipments without prior consultation with AUK Corp..

Specifications mentioned in this publication are subject to change without notice.