

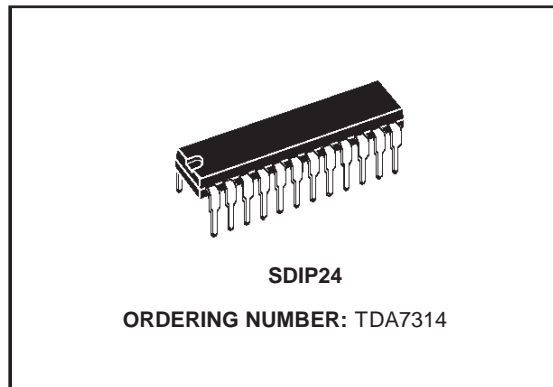

# TDA7314

## DIGITAL CONTROLLED AUDIO PROCESSOR WITH LOUDNESS

- 1 STEREO INPUT
- SELECTABLE INPUT GAIN FOR OPTIMAL ADAPTION TO DIFFERENT SOURCES
- INPUT AND OUTPUT FOR EXTERNAL EQUALIZER OR NOISE REDUCTION SYSTEM
- LOUDNESS FUNCTION
- VOLUME CONTROL IN 1.25dB STEPS
- TREBLE AND BASS CONTROL
- FOUR SPEAKER ATTENUATORS:
  - 4 INDEPENDENT SPEAKERS CONTROL IN 1.25dB STEPS FOR BALANCE AND FADER FACILITIES
  - INDEPENDENT MUTE FUNCTION
- ALL FUNCTIONS PROGRAMMABLE VIA SERIAL BUS



### DESCRIPTION

The TDA7314 is a volume, tone (bass and treble) balance (Left/Right) and fader (front/rear) processor for quality audio applications in car radio and Hi-Fi systems.

Selectable input gain and internal loudness function are provided. Control is accomplished by serial bus microprocessor interface.

The AC signal setting is obtained by resistor networks and switches combined with operational amplifiers.

Thanks to the used BIPOLAR/CMOS Technology, Low Distortion, Low Noise and DC stepping are obtained.

### PIN CONNECTION (Top view)

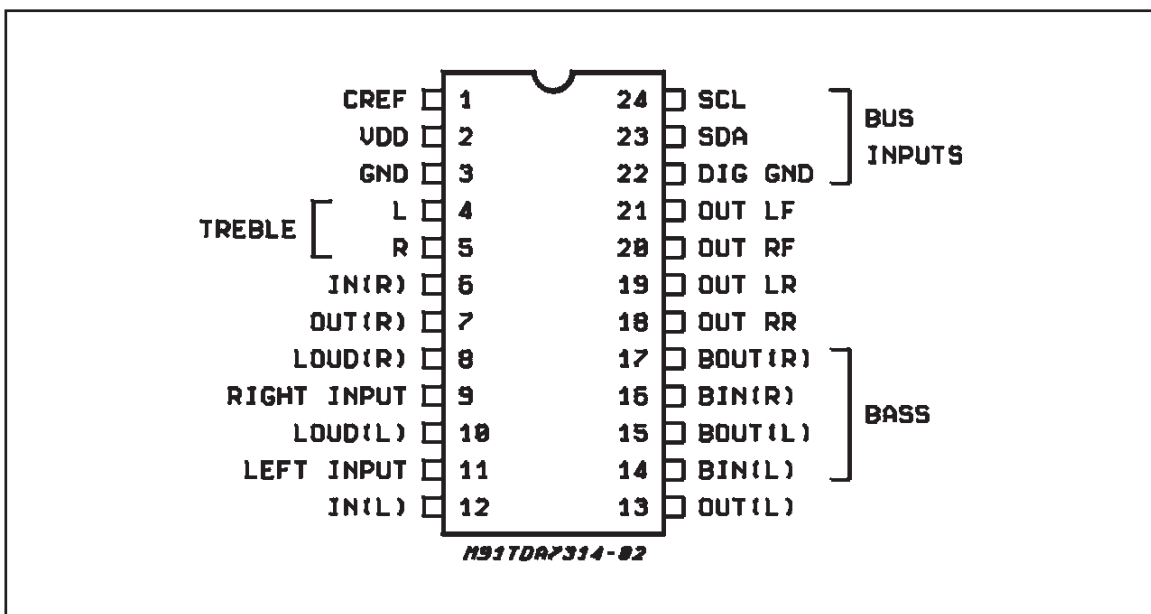

# TDA7314

## TEST CIRCUIT

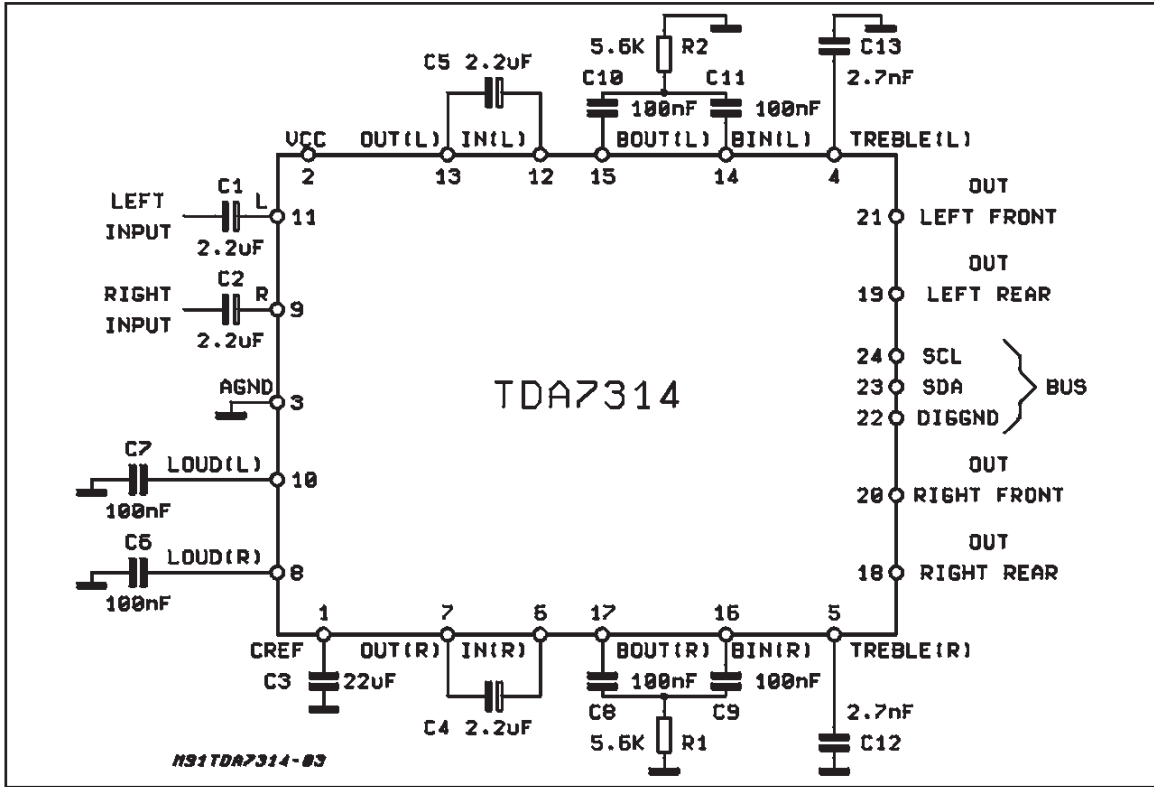

## THERMAL DATA

Symbol	Description	Value	Unit
$R_{thj-pins}$	Thermal Resistance Junction-pins	Max.	65 °C/W

## ABSOLUTE MAXIMUM RATINGS

Symbol	Parameter	Value	Unit
$V_S$	Operating Supply Voltage	10.2	V
$T_{amb}$	Operating Ambient Temperature	-40 to 85	°C
$T_{stg}$	Storage Temperature Range	-55 to +150	°C

## QUICK REFERENCE DATA

Symbol	Parameter	Min.	Typ.	Max.	Unit
$V_S$	Supply Voltage	6	9	10	V
$V_{CL}$	Max. input signal handling	2			V <sub>rms</sub>
THD	Total Harmonic Distortion $V = 1V_{rms}$ $f = 1KHz$		0.01	0.1	%
S/N	Signal to Noise Ratio		106		dB
$S_C$	Channel Separation $f = 1KHz$		103		dB
	Volume Control 1.25dB step	-78.75		0	dB
	Bass and Treble Control 2db step	-14		+14	dB
	Fader and Balance Control 1.25dB step	-38.75		0	dB
	Input Gain 6.25dB step	0		18.75	dB
	Mute Attenuation		100		dB

BLOCK DIAGRAM

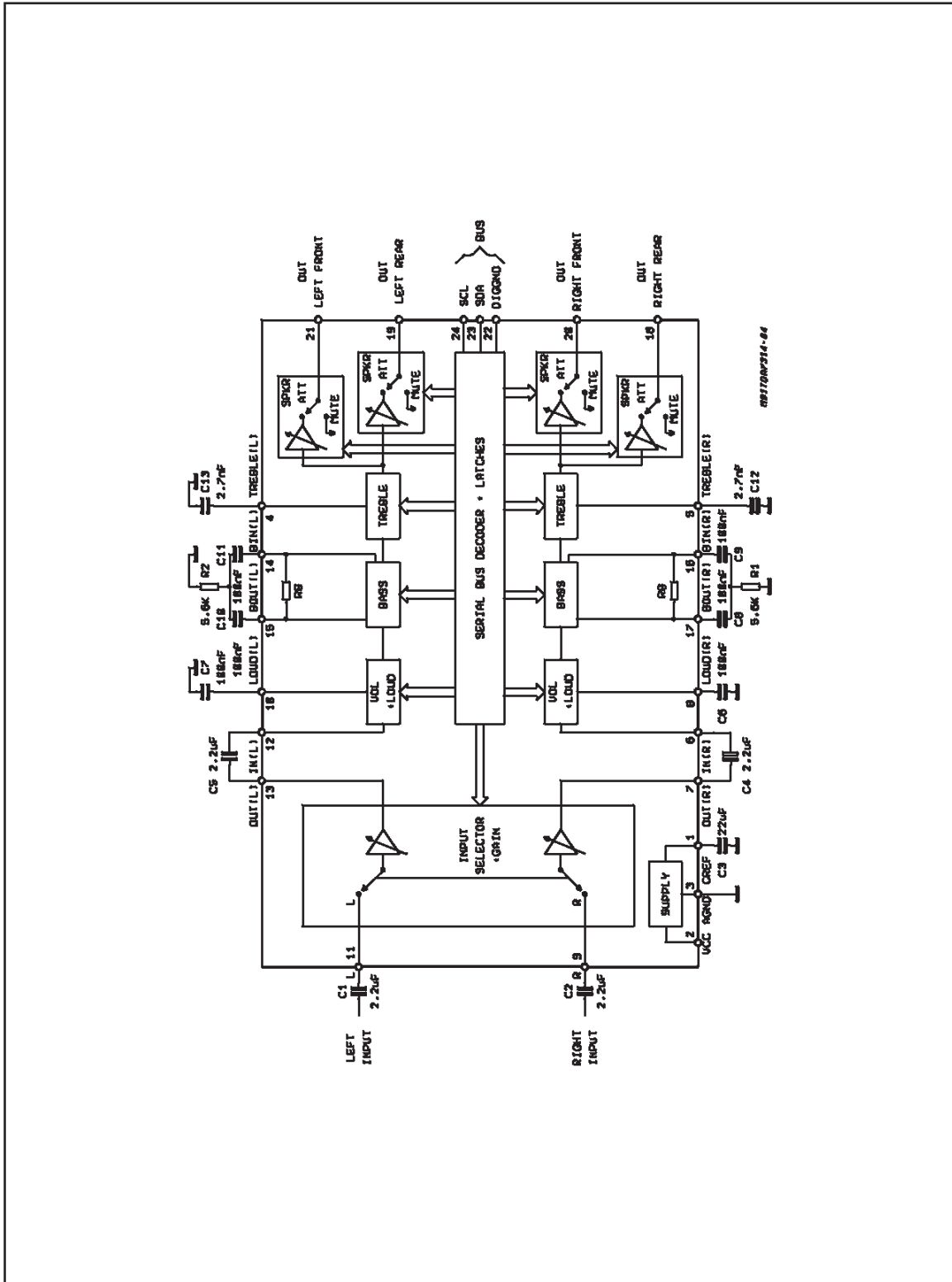

## TDA7314

**ELECTRICAL CHARACTERISTICS** (refer to the test circuit  $T_{amb} = 25^{\circ}\text{C}$ ,  $V_S = 9\text{V}$ ,  $R_L = 10\text{K}\Omega$ ,  $R_G = 600\Omega$ , all controls flat ( $G = 0$ ),  $f = 1\text{KHz}$  unless otherwise specified)

Symbol	Parameter	Test Condition	Min.	Typ.	Max.	Unit
--------	-----------	----------------	------	------	------	------

### SUPPLY

$V_S$	Supply Voltage		6	9	10	V
$I_S$	Supply Current			8	11	mA
SVR	Ripple Rejection		60	80		dB

### INPUT STAGE

$R_{II}$	Input Resistance	Pin 9, 11	35	50	70	$\text{K}\Omega$
$V_{CL}$	Clipping Level		2	2.5		V <sub>rms</sub>
$R_L$	Output Load resistance	pin 7, 17	2			$\text{K}\Omega$
$G_{INmin}$	Min. Input Gain		-1	0	1	dB
$G_{INmax}$	Max. Input Gain			18.75		dB
$G_{STEP}$	Step Resolution			6.25		dB
$e_{IN}$	Input Noise	$G = 18.75\text{dB}$		2		$\mu\text{V}$
$V_{DC}$	DC Steps	adjacent gain steps		4	20	mV
		$G = 18.75$ to Mute		4		mV

### VOLUME CONTROL

$R_{IV}$	Input Resistance		20	33	50	$\text{k}\Omega$
$C_{RANGE}$	Control Range		70	75	80	dB
$A_{VMIN}$	Min. Attenuation		-1	0	1	dB
$A_{VMAX}$	Max. Attenuation		70	75	80	dB
$A_{STEP}$	Step Resolution		0.5	1.25	1.75	dB
$E_A$	Attenuation Set Error	$A_v = 0$ to $-20\text{dB}$	-1.25	0	1.25	dB
		$A_v = -20$ to $-60\text{dB}$	-3		2	dB
$E_T$	Tracking Error				2	dB
$V_{DC}$	DC Steps	adjacent attenuation steps		0	3	mV
		From $0\text{dB}$ to $A_v$ max		0.5	7.5	mV

### SPEAKER ATTENUATORS

$C_{range}$	Control Range		35	37.5	40	dB
$S_{STEP}$	Step Resolution		0.5	1.25	1.75	dB
$E_A$	Attenuation set error				1.5	dB
$A_{MUTE}$	Output Mute Attenuation		80	100		dB
$V_{DC}$	DC Steps	adjacent att. steps		0	3	mV
		from 0 to mute		1	10	mV

### BASS CONTROL (1)

$G_b$	Control Range	Max. Boost/cut	$\pm 12$	$\pm 14$	$\pm 16$	dB
$B_{STEP}$	Step Resolution		1	2	3	dB
$R_B$	Internal Feedback Resistance		34	44	58	$\text{K}\Omega$

### TREBLE CONTROL (1)

$G_t$	Control Range	Max. Boost/cut	$\pm 13$	$\pm 14$	$\pm 15$	dB
$T_{STEP}$	Step Resolution		1	2	3	dB

**ELECTRICAL CHARACTERISTICS** (continued)

Symbol	Parameter	Test Condition	Min.	Typ.	Max.	Unit
<b>AUDIO OUTPUTS</b>						
$V_{OCL}$	Clipping Level	$d = 0.3\%$	2	2.5		Vrms
$R_L$	Output Load Resistance		2			K $\Omega$
$C_L$	Output Load Capacitance				10	nF
$R_{OUT}$	Output resistance		30	75	120	$\Omega$
$V_{OUT}$	DC Voltage Level		4.2	4.5	4.8	V

**GENERAL**

$e_{NO}$	Output Noise	BW = 20-20KHz, flat output muted all gains = 0dB		2.5 5	15	$\mu$ V $\mu$ V
		A curve all gains = 0dB		3		$\mu$ V
S/N	Signal to Noise Ratio	all gains = 0dB; $V_O = 1V_{rms}$		106		dB
d	Distortion	$A_V = 0, V_{IN} = 1V_{rms}$		0.01	0.1	%
		$A_V = -20dB, V_{IN} = 1V_{rms}$		0.09	0.3	%
		$V_{IN} = 0.3V_{rms}$		0.04		%
$S_c$	Channel Separation left/right		80	103		dB
	Total Tracking error	$A_V = 0$ to -20dB -20 to -60 dB		0 0	1 2	dB dB

**BUS INPUTS**

$V_{IL}$	Input Low Voltage				1	V
$V_{IH}$	Input High Voltage		3			V
$I_{IN}$	Input Current		-5		+5	$\mu$ A
$V_O$	Output Voltage SDA Acknowledge	$I_O = 1.6mA$			0.4	V

**Note:**

(1) Bass and Treble response see attached diagram (fig.19). The center frequency and quality of the resonance behaviour can be chosen by the external circuitry. A standard first order bass response can be realized by a standard feedback network.

**Figure 1:** Loudness versus Volume Attenuation**Figure 2:** Loudness versus Frequency (C<sub>LOUD</sub> = 100nF)

Figure 3: Loudness versus External Capacitors



LOUDNESS  
 $V_s = 9V$   
 Volume = -40dB  
 All other control flat  
 $C_{in} = 2.2\mu F$   
 $C_{loud} = 220nF, 100nF, 33nF, 10nF, Open, Shorter to Vref$

Figure 4: Noise vs. Volume/Gain Settings

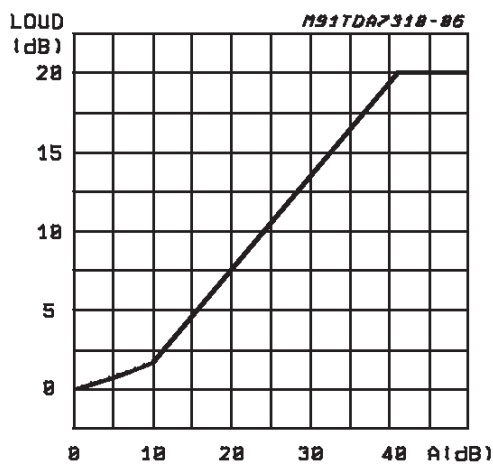
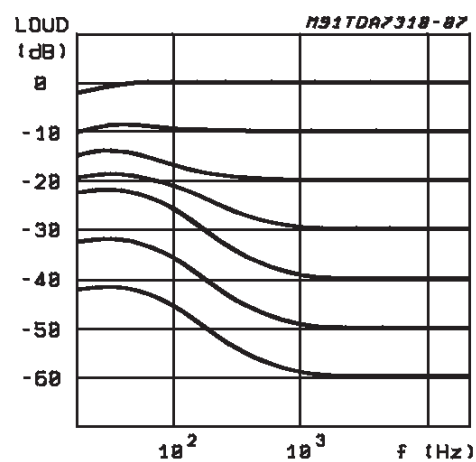
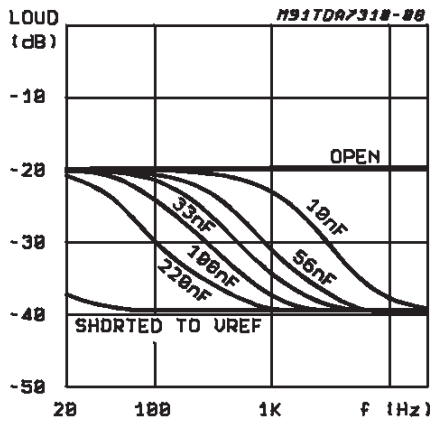
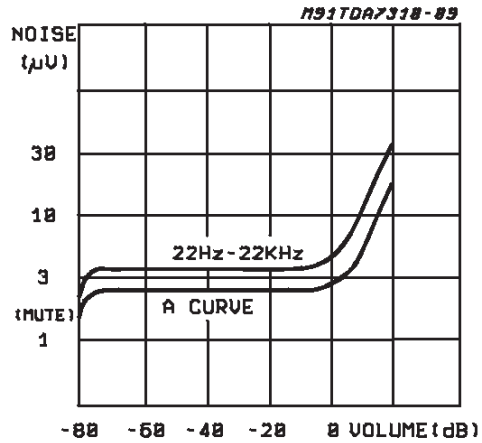

Figure 6: Distortion & Noise vs. Frequency

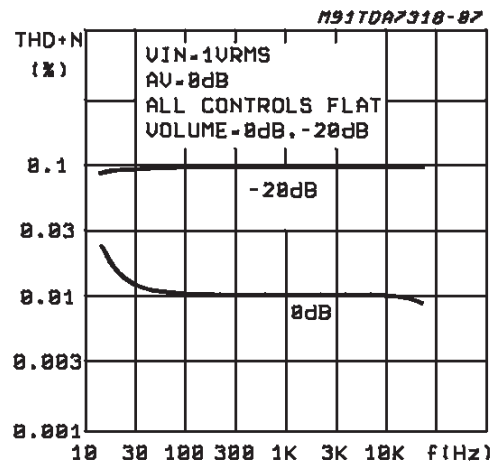

Figure 5: Signal to Noise Ratio vs. Volume Setting

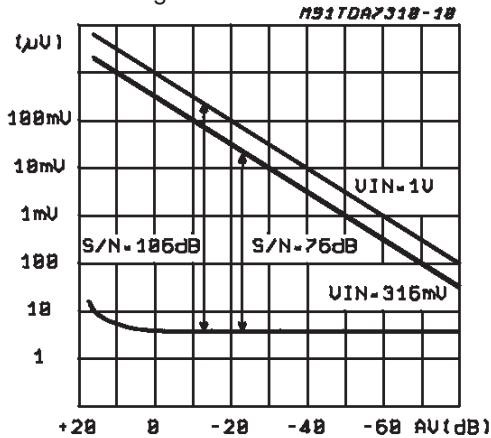

Figure 8: Distortion vs. Load Resistance

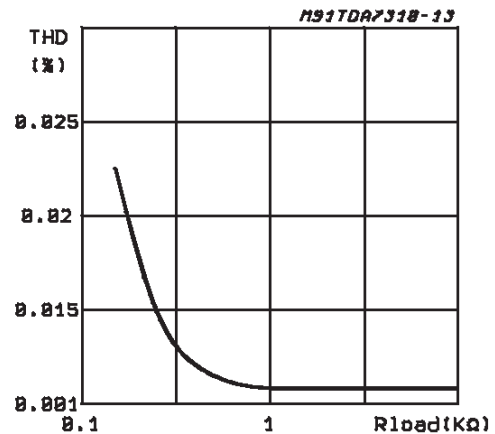

Figure 7: Distortion & Noise vs. Frequency

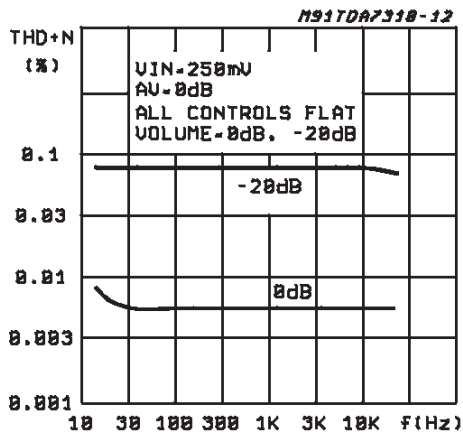

Figure 9: Channel Separation (L → R) vs. Frequency

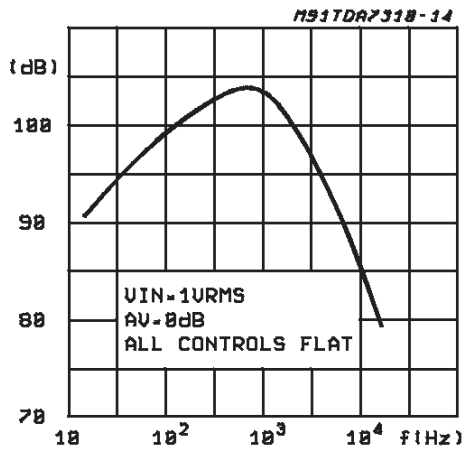

Figure 10: Supply Voltage Rejection vs. Frequency

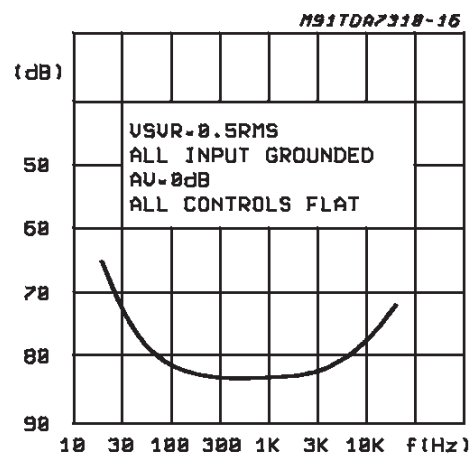

Figure 11: Output Clipping Level vs. Supply Voltage

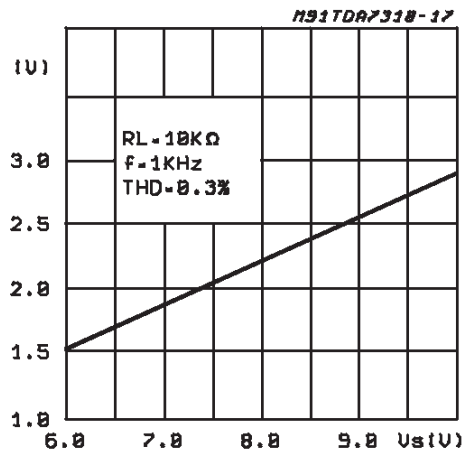

Figure 12: Quiescent Current vs. Supply Voltage

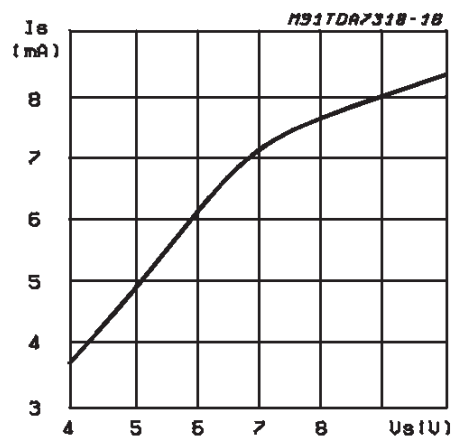

Figure 13: Supply Current vs. Temperature

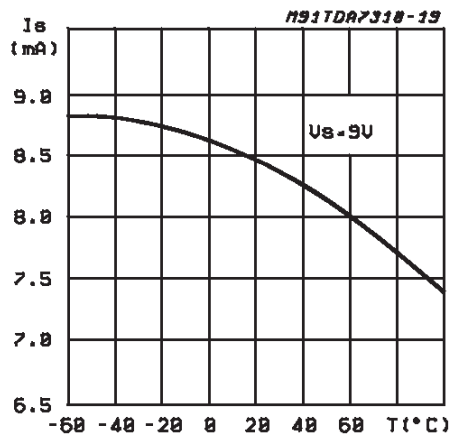
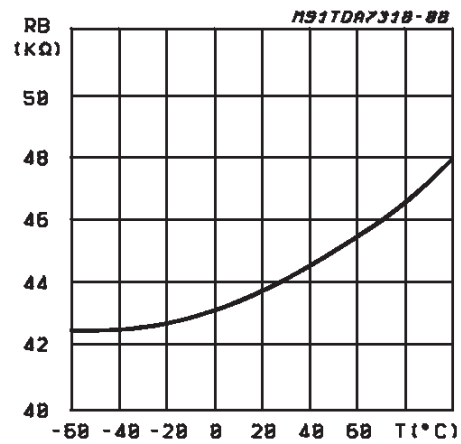
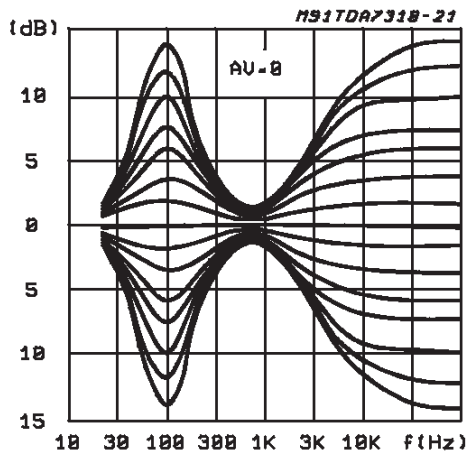

Figure 14: Bass Resistance vs. Temperature



## TDA7314

**Figure 15:** Typical Tone Response (with the ext. components indicated in the test circuit)



### SOFTWARE SPECIFICATION

#### Interface Protocol

The interface protocol comprises:

- A start condition (S)
- A chip address byte, containing the TDA7314 address (the 8th bit of the byte must be 0). The TDA7314 must always acknowledge at the end of each transmitted byte.
- A sequence of data (N-bytes + acknowledge)
- A stop condition (P)

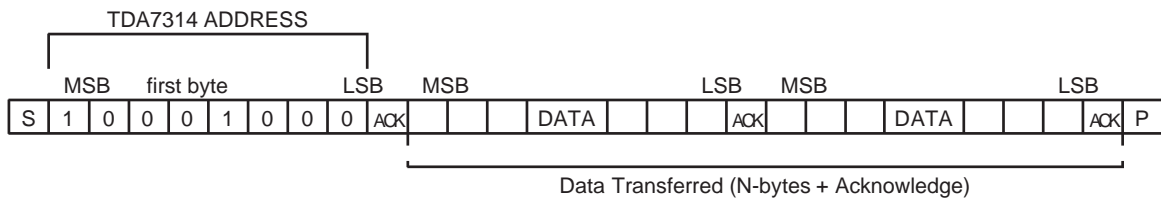

ACK = Acknowledge

S = Start

P = Stop

MAX CLOCK SPEED 100kbits/s

### SOFTWARE SPECIFICATION

Chip address

1	0	0	0	1	0	0	0
MSB							LSB

DATA BYTES

MSB					LSB				FUNCTION
0	0	B2	B1	B0	A2	A1	A0	Volume control	
1	1	0	B1	B0	A2	A1	A0	Speaker ATT LR	
1	1	1	B1	B0	A2	A1	A0	Speaker ATT RR	
1	0	0	B1	B0	A2	A1	A0	Speaker ATT LF	
1	0	1	B1	B0	A2	A1	A0	Speaker ATT RF	
0	1	0	G1	G0	S2	S1	S0	Audio switch	
0	1	1	0	C3	C2	C1	C0	Bass control	
0	1	1	1	C3	C2	C1	C0	Treble control	

Ax = 1.25dB steps; Bx = 10dB steps; Cx = 2dB steps; Gx = 6.25dB steps



**SOFTWARE SPECIFICATION** (continued)

## DATA BYTES (detailed description)

**Volume**

MSB						LSB			FUNCTION
0	0		B2	B1	B0	A2	A1	A0	Volume 1.25dB steps
						0	0	0	0
						0	0	1	-1.25
						0	1	0	-2.5
						0	1	1	-3.75
						1	0	0	-5
						1	0	1	-6.25
						1	1	0	-7.5
						1	1	1	-8.75
0	0		B2	B1	B0	A2	A1	A0	Volume 10dB steps
			0	0	0				0
			0	0	1				-10
			0	1	0				-20
			0	1	1				-30
			1	0	0				-40
			1	0	1				-50
			1	1	0				-60
			1	1	1				-70

For example a volume of -45dB is given by:

0 0 1 0 0 1 0 0

**Speaker Attenuators**

MSB						LSB			FUNCTION
1	0	0	B1	B0	A2	A1	A0	Speaker LF	
1	0	1	B1	B0	A2	A1	A0	Speaker RF	
1	1	0	B1	B0	A2	A1	A0	Speaker LR	
1	1	1	B1	B0	A2	A1	A0	Speaker RR	
					0	0	0	0	
					0	0	1	-1.25	
					0	1	0	-2.5	
					0	1	1	-3.75	
					1	0	0	-5	
					1	0	1	-6.25	
					1	1	0	-7.5	
					1	1	1	-8.75	
			0	0				0	
			0	1				-10	
			1	0				-20	
			1	1				-30	
			1	1	1	1	1	Mute	

For example attenuation of 25dB on speaker RF is given by:

1 0 1 1 0 1 0 0

## TDA7314

### Audio Switch

MSB								LSB	FUNCTION
0	1	0	G1	G0	S2	S1	S0	Audio Switch	
						0	0	Stereo 1	
						0	1	Stereo 2 (MUTE) (*)	
						1	0	Stereo 3 (MUTE) (*)	
						1	1	Stereo 4 (MUTE) (*)	
					0			LOUDNESS ON	
					1			LOUDNESS OFF	
			0	0				+18.75dB	
			0	1				+12.5dB	
			1	0				+6.25dB	
			1	1				0dB	

For example to select the stereo 1 input with a gain of +12.5dB, loudness on, the 8 bit string is:

0 1 0 0 1 0 0 0

(\*) Stereo 2, 3, 4 are connected internally but not available on pins.

### Bass and Treble

0	1	1	0	C3	C2	C1	C0	Bass Treble
0	1	1	1	C3	C2	C1	C0	
				0	0	0	0	-14
				0	0	0	1	-12
				0	0	1	0	-10
				0	0	1	1	-8
				0	1	0	0	-6
				0	1	0	1	-4
				0	1	1	0	-2
				0	1	1	1	0
				1	1	1	1	0
				1	1	1	0	2
				1	1	0	1	4
				1	1	0	0	6
				1	0	1	1	8
				1	0	1	0	10
				1	0	0	1	12
				1	0	0	0	14

C3 = Sign

For example Bass at -10dB is obtained by the following 8 bit string:

0 1 1 0 0 0 1 0

DIM.	mm			inch		
	MIN.	TYP.	MAX.	MIN.	TYP.	MAX.
A			5.08			0.20
A1	0.51			0.020		
A2	3.05	3.30	4.57	0.120	0.130	0.180
B	0.36	0.46	0.56	0.0142	0.0181	0.0220
B1	0.76	1.02	1.14	0.030	0.040	0.045
c	0.23	0.25	0.38	0.009	0.0098	0.0150
D	22.61	22.86	23.11	0.890	0.90	0.910
E	7.62		8.64	0.30		0.340
E1	6.10	6.40	6.86	0.240	0.252	0.270
e		1.778			0.070	
e1		7.62			0.30	
e2			10.92			0.430
e3			1.52			0.060
L	2.54	3.30	3.81	0.10	0.130	0.150

## OUTLINE AND MECHANICAL DATA

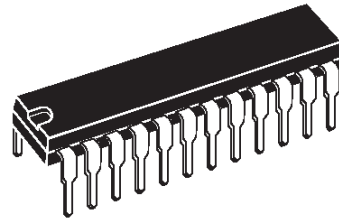

## SDIP24 (0.300")

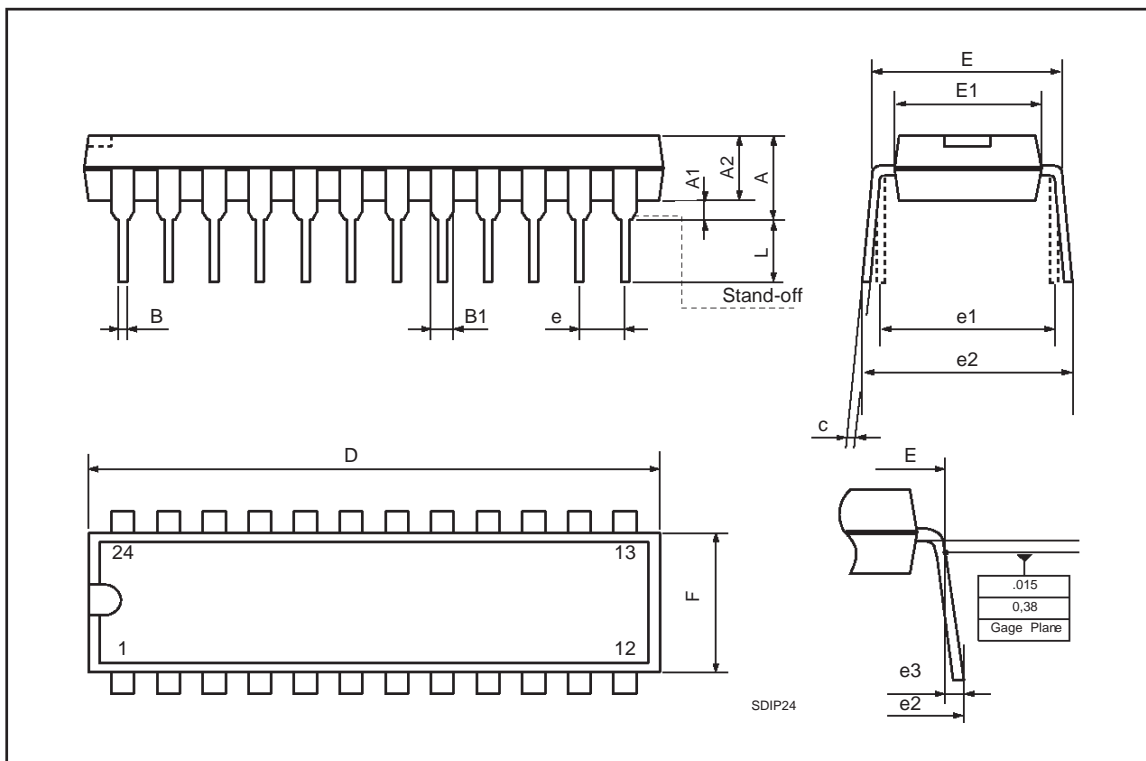

Information furnished is believed to be accurate and reliable. However, STMicroelectronics assumes no responsibility for the consequences of use of such information nor for any infringement of patents or other rights of third parties which may result from its use. No license is granted by implication or otherwise under any patent or patent rights of STMicroelectronics. Specification mentioned in this publication are subject to change without notice. This publication supersedes and replaces all information previously supplied. STMicroelectronics products are not authorized for use as critical components in life support devices or systems without express written approval of STMicroelectronics.

The ST logo is a registered trademark of STMicroelectronics

© 1999 STMicroelectronics – Printed in Italy – All Rights Reserved

STMicroelectronics GROUP OF COMPANIES

Australia - Brazil - China - Finland - France - Germany - Hong Kong - India - Italy - Japan - Malaysia - Malta - Morocco -  
Singapore - Spain - Sweden - Switzerland - United Kingdom - U.S.A.

<http://www.st.com>