

DATA SHEET



TEA6849H

New In Car Entertainment car radio tuner IC with Precision Adjacent Channel Suppression (NICE-PACS)

Product specification

2003 Dec 19

New In Car Entertainment car radio tuner IC with Precision Adjacent Channel Suppression (NICE-PACS)

TEA6849H

CONTENTS	10	DC CHARACTERISTICS
1 FEATURES	11	AC CHARACTERISTICS
2 GENERAL DESCRIPTION	12	I ² C-BUS PROTOCOL
3 ORDERING INFORMATION	12.1	I ² C-bus specification
4 QUICK REFERENCE DATA	12.1.1	Data transfer
5 BLOCK DIAGRAM	12.1.2	I ² C-bus pull-up resistors
6 PINNING	12.1.3	Frequency setting
7 FUNCTIONAL DESCRIPTION	12.1.4	Default settings
7.1 Oscillators	12.2	I ² C-bus protocol
7.1.1 VCO	12.2.1	Data transfer mode and IC address
7.1.2 PLL	12.2.2	Write mode: data byte 0
7.1.3 Crystal oscillator	12.2.3	Write mode: data byte 1
7.2 DAA	12.2.4	Write mode: data byte 2
7.3 FM signal channel	12.2.5	Write mode: data byte 3
7.3.1 FM mixer 1	12.2.6	Write mode: data byte 4
7.3.2 Buffer output for weather band flag (pin WBFLAG)	12.2.7	Write mode: data byte 5
7.3.3 FM keyed AGC	12.2.8	Write mode: data byte 6
7.3.4 FM IF amplifier	12.2.9	Write mode: data byte 7
7.3.5 FM mixer 2	12.2.10	Read mode: data byte 0
7.3.6 FM IF2 dynamic selectivity	13	TEST AND APPLICATION INFORMATION
7.3.7 FM quadrature demodulator	14	INTERNAL CIRCUITRY
7.3.8 FM MPX soft mute	15	PACKAGE OUTLINE
7.3.9 Adjacent channel detector and threshold extension	16	SOLDERING
7.3.10 Bandwidth control 'active' flag (pin IFBWFLAG)	16.1	Introduction to soldering surface mount packages
7.3.11 Bandwidth control monitor voltage (pin V _{IFBW})	16.2	Reflow soldering
7.4 AM signal channel	16.3	Wave soldering
7.4.1 AM tuner including mixer 1 and mixer 2	16.4	Manual soldering
7.4.2 AM RF AGC	16.5	Suitability of surface mount IC packages for wave and reflow soldering methods
7.4.3 AM detector	17	DATA SHEET STATUS
7.4.4 AM noise blanker	18	DEFINITIONS
7.5 FM and AM level detector	19	DISCLAIMERS
8 LIMITING VALUES	20	PURCHASE OF PHILIPS I ² C COMPONENTS
9 THERMAL CHARACTERISTICS		

New In Car Entertainment car radio tuner IC with Precision Adjacent Channel Suppression (NICE-PACS)

TEA6849H

1 FEATURES

- FM mixer 1 for conversion of FM RF (65 to 108 MHz and US weather band) to IF of 10.7 MHz; the mixer provides inherent image rejection; for European and US FM band/WB (weather band) the mixer is driven with a 'high' injection Local Oscillator (LO); in Japan FM band and East Europe FM band the mixer is driven with a 'low' injection LO
- AM mixer 1 for conversion of AM RF to AM IF1 of 10.7 MHz
- LC tuner oscillator providing mixer frequencies for FM mixer and AM mixer 1
- AM mixer 2 for conversion of AM IF1 to AM IF2 of 450 kHz
- Crystal oscillator providing mixer frequencies for AM mixer 2 and FM mixer 2 and reference for synthesizer PLL, IF count, timing for Radio Data System (RDS) update and reference frequency for car audio signal processor ICs
- Fast synthesizer PLL tuning system with local control for inaudible RDS updating
- Timing function for RDS update algorithm and control signal output for car audio signal processor ICs (TEA688x, SAA77xx, TEF689x)
- I²C-bus adjustable FM MPX soft mute
- Digital alignment circuit for bus controlled matching of oscillator tuning voltage to FM antenna tank circuit tuning voltage
- AGC PIN diode drive circuit for FM RF AGC; AGC detection at FM mixer input; the AGC PIN diode drive can be activated by the I²C-bus as a local function for search tuning; AGC threshold is a programmable and keyed function switchable via the I²C-bus
- FM IF linear amplifier with high dynamic input range
- FM mixer 2 for conversion of FM IF1 to FM IF2 of 450 kHz with inherent image rejection
- Fully integrated dynamic selectivity and FM demodulator at IF2; improved sensitivity with dynamic threshold extension; centre frequency of IF2 selectivity alignment via the I²C-bus
- Level detector for AM and FM with temperature compensated output voltage; starting point and slope of level output is programmable via the I²C-bus
- AM cascode AGC stage and RF PIN diode drive circuit; AGC threshold detection at AM mixer 1 and IF2 AGC input; threshold for detection at mixer 1 input is programmable via the I²C-bus
- AM IF2 AGC and demodulator
- AM AF output switchable to provide AM IF2 for AM stereo decoder
- AM noise blanker with detection at IF1 and blanking at AM IF2
- Software controlled flag output
- Buffer output for weather band flag
- Adjacent channel detector and modulation detector for instantaneous bandwidth control of the integrated filter
- Flag and voltage output indicating the actual bandwidth.



2 GENERAL DESCRIPTION

The TEA6849H is a single IC with car radio tuner for AM, FM and Weather Band (WB) intended for microcontroller tuning with the I²C-bus. It provides the following functions:

- AM double conversion receiver for LW, MW and SW (31 m, 41 m and 49 m bands) with IF1 = 10.7 MHz and IF2 = 450 kHz
- FM double conversion receiver with integrated image rejection for IF1 and for IF2 capable of selecting US FM, US weather, Europe FM, East Europe FM and Japan FM bands; fully integrated dynamic selectivity at 450 kHz FM IF2; FM demodulator with dynamic threshold extension; centre frequency alignment of IF2 selectivity via the I²C-bus
- The tuning system includes VCO, crystal oscillator and PLL synthesizer on one chip.

3 ORDERING INFORMATION

TYPE NUMBER	PACKAGE		
	NAME	DESCRIPTION	VERSION
TEA6849H	LQFP80	plastic low profile quad flat package; 80 leads; body 12 × 12 × 1.4 mm	SOT315-1

New In Car Entertainment car radio tuner IC with Precision Adjacent Channel Suppression (NICE-PACS)

TEA6849H

4 QUICK REFERENCE DATA

SYMBOL	PARAMETER	CONDITIONS	MIN.	TYP.	MAX.	UNIT
$V_{DDA(n)}$	analog supply voltage 1 to 4 and 6		8	8.5	9	V
$I_{DDA(tot)}$	sum of analog supply currents 1 to 4 and 6	FM mode	45	56	67	mA
		AM mode	40	50	60	mA
V_{DDA5}	analog supply voltage 5		4.75	5	5.25	V
I_{DDA5}	analog supply current 5	FM mode	–	7.4	–	mA
		AM mode	–	11	–	mA
V_{DDD}	digital supply voltage		4.75	5	5.25	V
I_{DDD}	digital supply current	FM mode	21	26	31	mA
		AM mode	22	27	32	mA
$f_{AM(ant)}$	AM input frequency	LW	0.144	–	0.288	MHz
		MW	0.522	–	1.710	MHz
		SW	5.730	–	9.99	MHz
$f_{FM(ant)}$	FM input frequency		65	–	108	MHz
$f_{FM(WB)(ant)}$	FM weather band input frequency		162.4	–	162.55	MHz
T_{amb}	ambient temperature		–40	–	+85	°C
AM overall system parameters; see Figs 12 and 13						
$(S+N)/N$	signal plus noise-to-noise ratio	$m = 0.3$; $B_{AF} = 2.15$ kHz	–	59	–	dB
THD	total harmonic distortion	$m = 0.8$; $f_{mod} = 1$ kHz	–	0.3	–	%
$V_{sens(rms)}$	sensitivity (RMS value)	$m = 0.3$; $f_{mod} = 1$ kHz; (S+N)/N = 26 dB; with European dummy aerial 15 pF/60 pF; $B_{AF} = 2.15$ kHz	–	45	–	μV
FM overall system parameters; see Figs 12 and 13						
$(S+N)/N$	signal plus noise-to-noise ratio	$\Delta f = 22.5$ kHz; de-emphasis = 50 μs; $B_{AF} = 300$ Hz to 15 kHz	–	63	–	dB
THD	total harmonic distortion	$\Delta f = 75$ kHz; with $2 \times SFE10.7MS3$	–	0.35	–	%
$V_{sens(rms)}$	sensitivity (RMS value)	$\Delta f = 22.5$ kHz; $f_{mod} = 1$ kHz; (S+N)/N = 26 dB; de-emphasis = 50 μs; $B_{AF} = 300$ Hz to 15 kHz; with 75 Ω dummy antenna	–	1.4	2	μV

New In Car Entertainment car radio tuner IC with Precision Adjacent Channel Suppression (NICE-PACS)

TEA6849H

5 BLOCK DIAGRAM

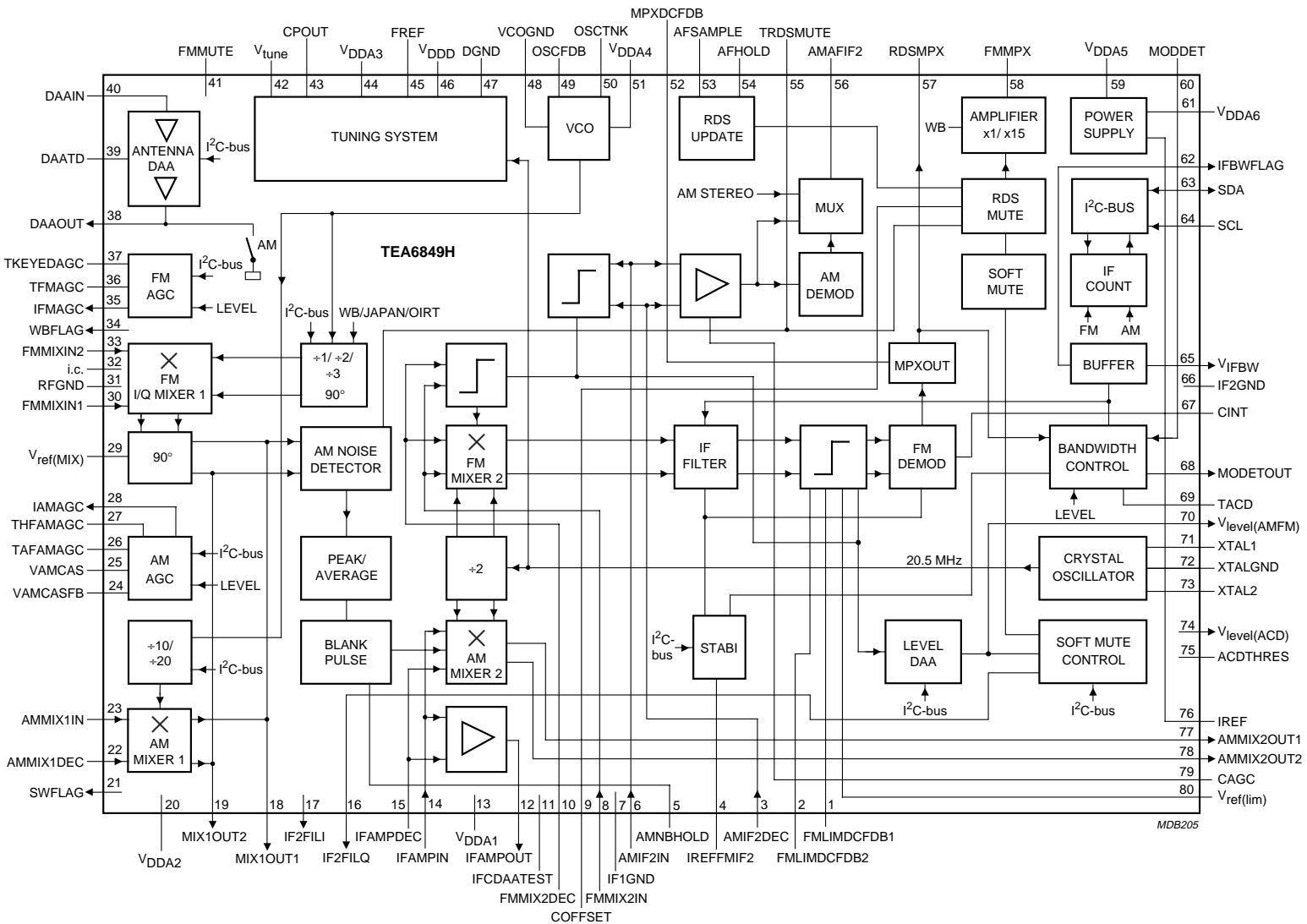

Fig.1 Block diagram.

New In Car Entertainment car radio tuner IC with Precision Adjacent Channel Suppression (NICE-PACS)

TEA6849H

6 PINNING

SYMBOL	PIN	DESCRIPTION
FMLIMDCFDB1	1	decoupling in-phase FM limiter
FMLIMDCFDB2	2	decoupling quadrature phase FM limiter
AMIF2DEC	3	decoupling for AM IF2 input
IREFFMIF2	4	reference current for FM IF2
AMNBHOLD	5	AM noise blanker threshold
AMIF2IN	6	AM IF2 input (450 kHz) for demodulator AGC and AM level detector
IF1GND	7	AM IF1 ground
FMMIX2IN	8	FM mixer 2 input
COFFSET	9	DC feedback for offset compensation RDS mute
FMMIX2DEC	10	FM mixer 2 decoupling
IFCDAATEST	11	test pin for IF centre DAA
IFAMPOUT	12	IF amplifier output (10.7 MHz)
V _{DDA1}	13	analog supply voltage 1 (8.5 V) for FM IF amplifier
IFAMPIN	14	FM IF amplifier and AM mixer 2 input (10.7 MHz)
IFAMPDEC	15	FM IF amplifier and AM mixer 2 decoupling
IF2FILQ	16	test output quadrature phase FM IF2 filter; time constant FM soft mute
IF2FILI	17	test output in-phase FM IF2 filter
MIX1OUT1	18	FM mixer and AM mixer 1 IF output 1 (10.7 MHz)
MIX1OUT2	19	FM mixer and AM mixer 1 IF output 2 (10.7 MHz)
V _{DDA2}	20	analog supply voltage 2 (8.5 V) for FM and AM RF
SWFLAG	21	output software programmable flag
AMMIX1DEC	22	AM mixer 1 decoupling
AMMIX1IN	23	AM mixer 1 input
VAMCASFB	24	feedback for cascode AM AGC
VAMCAS	25	cascode AM AGC
TAFAMAGC	26	AF time constant of AM front-end AGC
THFAMAGC	27	HF time constant of AM front-end AGC
IAMAGC	28	PIN diode drive current output of AM front-end AGC
V _{ref(MIX)}	29	reference voltage for FM RF mixer
FMMIXIN1	30	FM RF mixer input 1
RFGND	31	RF ground
i.c.	32	internal connection
FMMIXIN2	33	FM RF mixer input 2
WBFLAG	34	buffered weather band flag output
IFMAGC	35	PIN diode drive current output of FM front-end AGC
TFMAGC	36	time constant of FM front-end AGC
TKEYEDAGC	37	time constant of keyed FM front-end AGC
DAAOUT	38	output of digital auto alignment circuit for antenna tank circuit
DAATD	39	temperature compensation diode for digital auto alignment circuit for antenna tank circuit
DAAIN	40	input of digital auto alignment circuit for antenna tank circuit

New In Car Entertainment car radio tuner IC with Precision Adjacent Channel Suppression (NICE-PACS)

TEA6849H

SYMBOL	PIN	DESCRIPTION
FMMUTE	41	test output for FM soft mute bits
V _{tune}	42	tuning voltage
CPOUT	43	charge pump output
V _{DDA3}	44	analog supply voltage 3 (8.5 V) for tuning PLL
FREF	45	reference frequency output for signal processor IC
V _{DDD}	46	digital supply voltage (5 V)
DGND	47	digital ground
VCOGND	48	VCO ground
OSCFDB	49	VCO feedback
OSCTNK	50	VCO tank circuit
V _{DDA4}	51	analog supply voltage 4 (8.5 V) for VCO
MPXDCFDB	52	DC feedback for FM MPX signal path
AFSAMPLE	53	AF sample flag output for car audio signal processor IC
AFHOLD	54	AF hold flag output for car audio signal processor IC
TRDSMUTE	55	time constant for RDS update mute
AMAFIF2	56	AM demodulator AF output or IF2 output for AM stereo (multiplexed by I ² C-bus)
RDSMPX	57	MPX output for RDS decoder and signal processor (not muted)
FMMPX	58	FM demodulator MPX output
V _{DDA5}	59	analog supply voltage 5 (5 V) for on-chip power supply
MODDET	60	modulation detector input
V _{DDA6}	61	analog supply voltage 6 (8.5 V) for on-chip power supply
IFBWFLAG	62	FM IF2 bandwidth flag output
SDA	63	I ² C-bus data line input and output
SCL	64	I ² C-bus clock line input
V _{IFBW}	65	monitor voltage for FM IF2 bandwidth
IF2GND	66	AM IF2 ground
CINT	67	demodulator loop filter
MODETOUT	68	modulation detector output
TACD	69	adjacent channel detector time constant
V _{level(AMFM)}	70	level voltage output for AM and FM
XTAL1	71	crystal oscillator 1
XTALGND	72	crystal oscillator ground
XTAL2	73	crystal oscillator 2
V _{level(ACD)}	74	level voltage output for adjacent channel detector
ACDTHRES	75	adjacent channel detector threshold
IREF	76	reference current for power supply
AMMIX2OUT1	77	AM mixer 2 output 1 (450 kHz)
AMMIX2OUT2	78	AM mixer 2 output 2 (450 kHz)
CAGC	79	AM IF AGC capacitor
V _{ref(lim)}	80	limiter reference voltage

New In Car Entertainment car radio tuner IC with Precision Adjacent Channel Suppression (NICE-PACS)

TEA6849H

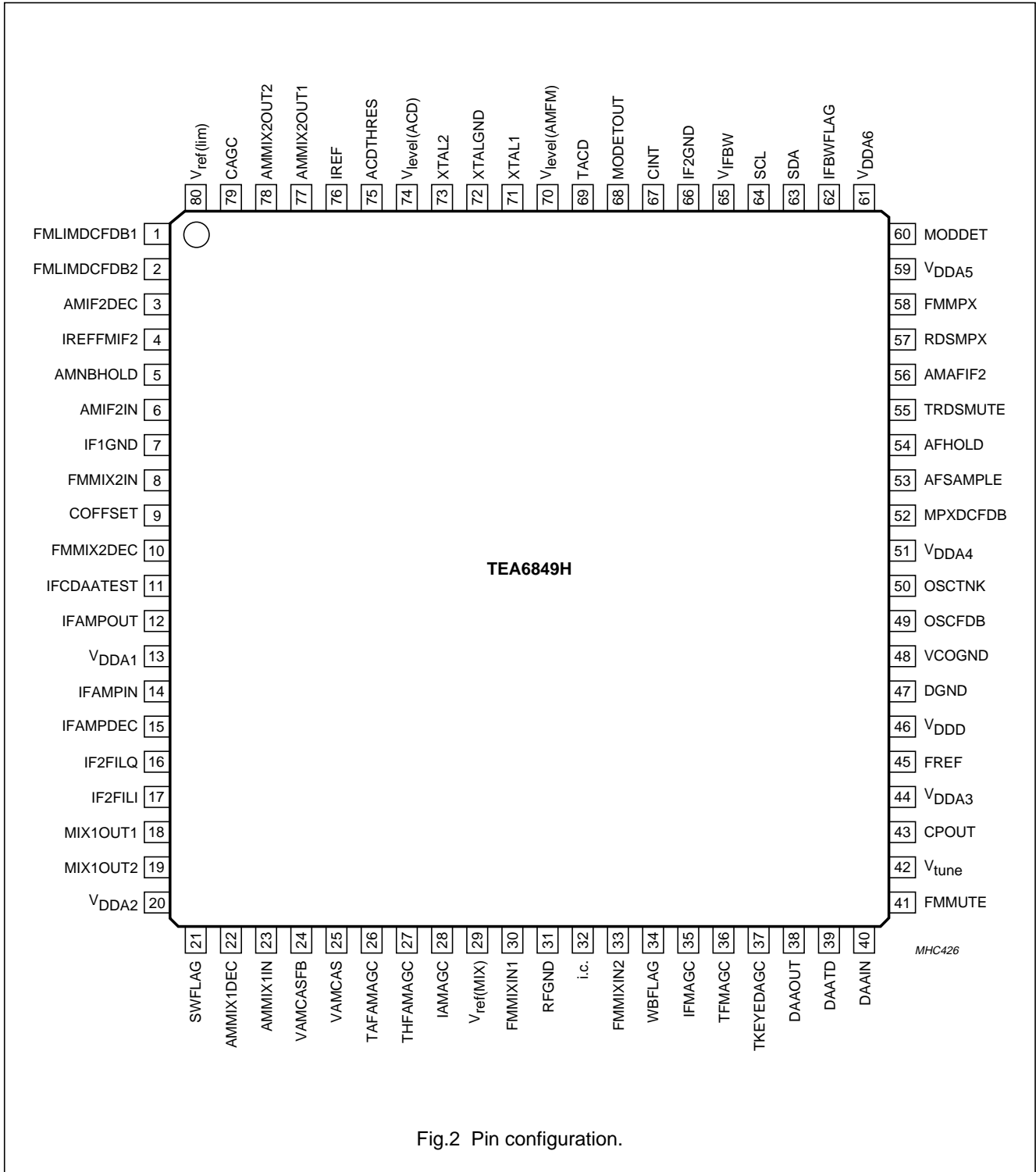

New In Car Entertainment car radio tuner IC with Precision Adjacent Channel Suppression (NICE-PACS)

TEA6849H

7 FUNCTIONAL DESCRIPTION

7.1 Oscillators

7.1.1 VCO

The varactor tuned VCO provides the local oscillator signal for both FM and AM mixer 1. It has a frequency range of 162.9 to 248.2 MHz.

7.1.2 PLL

Fast synthesizer PLL tuning system with local control for inaudible RDS updating.

7.1.3 CRYSTAL OSCILLATOR

The crystal oscillator provides a 20.5 MHz signal that is used for:

- Reference frequency for frequency synthesizer PLL
- Local oscillator for AM mixer 2 and FM mixer 2
- Reference frequency for the IF counter
- Timing signal for the RDS update algorithm
- Reference frequency (75.368 kHz) for the TEA688x (car audio signal processor - CASP) or TEF689x (car radio integrated signal processor - CRISP).

7.2 DAA

To reduce the number of manual alignments in production the following I²C-bus controlled Digital Auto Alignment (DAA) functions are included:

- FM RF DAA
 - 7-bit DAA circuitry for the conversion of the VCO tuning voltage to a controlled alignment voltage for the FM antenna tank circuit
- FM and AM level DAA
 - Level DAA circuitry for alignment of slope (3-bit) and starting point (5-bit) of the level curve
- IF2 centre DAA
 - Centre frequency alignment (7-bit) of integrated FM IF2 dynamic selectivity.

7.3 FM signal channel

7.3.1 FM MIXER 1

FM quadrature mixer converts FM RF (65 to 108 MHz and weather band) to IF of 10.7 MHz. The FM mixer provides inherent image rejection and high RF sensitivity.

It is capable of tuning the US FM, US weather, Europe FM, Japan FM and East Europe FM bands:

- US FM = 87.9 to 107.9 MHz
- US weather FM = 162.4 to 162.55 MHz
- Europe FM = 87.5 to 108 MHz
- Japan FM = 76 to 91 MHz
- East Europe FM = 65 to 74 MHz.

7.3.2 BUFFER OUTPUT FOR WEATHER BAND FLAG (PIN WBFLAG)

The buffer output on pin WBFLAG is HIGH for weather band mode.

7.3.3 FM KEYED AGC

The AGC threshold is programmable and the keyed AGC function is switchable via the I²C-bus. AGC detection occurs at the input of the first FM mixer. If the keyed AGC function is activated, the AGC is keyed only by the narrow band level. The AGC PIN diode drive can be activated via the I²C-bus as a local function for search tuning. The AGC sources a constant 10 mA current into the FM PIN diode in AM mode.

7.3.4 FM IF AMPLIFIER

The FM IF amplifier provides 18 dB amplification with high linearity over a wide dynamic range.

7.3.5 FM MIXER 2

The FM mixer 2 converts 10.7 MHz FM IF1 to 450 kHz FM IF2 in I and Q phase to achieve image rejection in the demodulator.

New In Car Entertainment car radio tuner IC with Precision Adjacent Channel Suppression (NICE-PACS)

TEA6849H

7.3.6 FM IF2 DYNAMIC SELECTIVITY

The IF bandwidth of the FM IF2 is automatically adjusted depending on modulation and reception conditions. The centre frequency of the selectivity is adjusted by a 7-bit instruction via the I²C-bus. The dynamic selectivity mode and three fixed bandwidths (**60, 90 and 130 kHz**) can be selected via the I²C-bus. The IF2 bandwidth is set to **13 kHz** in weather band mode.

7.3.7 FM QUADRATURE DEMODULATOR

The FM quadrature demodulator is adjustment free.

7.3.8 FM MPX SOFT MUTE

Muting depth and start of muting are adjustable via the I²C-bus (see Figs 8 and 9).

7.3.9 ADJACENT CHANNEL DETECTOR AND THRESHOLD EXTENSION

In the event of breakthrough of a strong neighbouring transmitter, the IF2 bandwidth is reduced dynamically. At low RF input voltages and low modulation levels the IF2 bandwidth is reduced to achieve improved sensitivity by demodulator threshold extension.

7.3.10 BANDWIDTH CONTROL 'ACTIVE' FLAG (PIN IFBWFLAG)

Flag output IBFW = 1 from pin IFBWFLAG indicates that the IF2 bandwidth is reduced.

7.3.11 BANDWIDTH CONTROL MONITOR VOLTAGE (PIN V_{IFBW})

The actual bandwidth is indicated by a voltage at pin V_{IFBW} that is proportional, not linear, to the IF bandwidth.

7.4 AM signal channel

7.4.1 AM TUNER INCLUDING MIXER 1 AND MIXER 2

The AM tuner is realized in a double conversion technique and is capable of selecting LW, MW and SW bands.

AM mixer 1 converts AM RF to IF1 of 10.7 MHz, while AM mixer 2 converts IF1 of 10.7 MHz to IF2 of 450 kHz:

- LW = 144 to 288 kHz
- MW = 530 to 1710 kHz (US AM band)
- SW = 5.73 to 9.99 MHz (including the 31 m, 41 m and 49 m bands).

7.4.2 AM RF AGC

The AM wideband AGC in front of the first AM mixer is realized first by a cascaded NPN transistor, which controls the transconductance of the RF amplifier JFET with 10 dB of AGC range. Second, an AM PIN diode stage with antenna type and frequency dependent AGC range is available. The minimum JFET drain source voltage is controlled by a DC feedback loop (pin VAMCASFB) in order to limit the cascode AGC range to 10 dB. If the cascode AGC is not required, a simple RF AGC loop is possible by using only a PIN diode. In this event pins VAMCASFB and VAMCAS have to be open-circuit. In FM mode, the cascade switches off the JFET bias current to reduce total power consumption. The PIN diode is biased by 1 mA in FM mode.

The AGC detection points for AM AGC are at the first AM mixer input (threshold programmable via the I²C-bus) and the IF2 AGC input (fixed threshold).

7.4.3 AM DETECTOR

The AM output provides either a detected AM AF or the corresponding AM IF2 signal. The IF2 signal can be used for AM stereo decoder processing. Soft mute function is controlled by the I²C-bus in AM mono mode.

7.4.4 AM NOISE BLANKER

The detection point for the AM noise blanker is the output stage of AM mixer 1, while blanking is realized at the output of the mixer 2.

Trigger sensitivity can be modified by adding an external resistor at pin AMNBHOLD.

7.5 FM and AM level detector

FM and AM level detectors provide the temperature compensated output voltage. The starting points and slopes of the level detector outputs are programmable via the I²C-bus.

New In Car Entertainment car radio tuner IC with Precision Adjacent Channel Suppression (NICE-PACS)

TEA6849H

8 LIMITING VALUES

In accordance with the Absolute Maximum Rating System (IEC 60134).

SYMBOL	PARAMETER	CONDITIONS	MIN.	MAX.	UNIT
V _{DDA1}	analog supply voltage 1 for FM IF amplifier		-0.3	+10	V
V _{DDA2}	analog supply voltage 2 for FM and AM RF		-0.3	+10	V
V _{DDA3}	analog supply voltage 3 for tuning PLL		-0.3	+10	V
V _{DDA4}	analog supply voltage 4 for voltage controlled oscillator		-0.3	+10	V
V _{DDA5}	analog supply voltage 5 for on-chip power supply		-0.3	+6.5	V
V _{DDA6}	analog supply voltage 6 for on-chip power supply		-0.3	+10	V
V _{DD}	digital supply voltage		-0.3	+6.5	V
$\Delta V_{DD8.5-DD5}$	difference between any 8.5 V supply voltage and any 5 V supply voltage	note 1	-0.3	-	V
T _{stg}	storage temperature		-55	+150	°C
T _{amb}	ambient temperature		-40	+85	°C
V _{es}	electrostatic handling voltage	note 2	-200	+200	V
		note 3	-2000	+2000	V

Notes

- To avoid damage and wrong operation it is necessary to keep all 8.5 V supply voltages at a higher level than any 5 V supply voltage. This is also necessary during power-on and power-down sequences. Precautions have to be provided in such a way that interference cannot pull down the 8.5 V supply below the 5 V supply.
- Machine model (R = 0 Ω , C = 200 pF).
- Human body model (R = 1.5 k Ω , C = 100 pF).

9 THERMAL CHARACTERISTICS

SYMBOL	PARAMETER	CONDITIONS	VALUE	UNIT
R _{th(j-a)}	thermal resistance from junction to ambient	in free air	54	K/W
R _{th(j-c)}	thermal resistance from junction to case		9	K/W

New In Car Entertainment car radio tuner IC with Precision Adjacent Channel Suppression (NICE-PACS)

TEA6849H

10 DC CHARACTERISTICS

$V_{DDA6} = 8.5\text{ V}$; $V_{DDA5} = 5\text{ V}$; $V_{DDD} = 5\text{ V}$; $T_{amb} = 25\text{ }^{\circ}\text{C}$; tested in the circuit of Figs 12 and 13; unless otherwise specified.

SYMBOL	PARAMETER	CONDITIONS	MIN.	TYP.	MAX.	UNIT
Supply voltage						
$V_{DDA(n)}$	analog supply voltages 1 to 4 and 6		8	8.5	9	V
V_{DDA5}	analog supply voltage 5		4.75	5	5.25	V
V_{DDD}	digital supply voltage		4.75	5	5.25	V
Supply current in FM mode						
I_{DDD}	digital supply current	Europe/US band	21	26	31	mA
		Japan/East Europe band	26.5	33	39.5	mA
I_{DDA1}	analog supply current 1 for FM IF amplifier		5.5	7.3	8.8	mA
I_{DDA2}	analog supply current 2 for FM RF		4.2	5.2	6.2	mA
I_{DDA3}	analog supply current 3 for tuning PLL		3.2	4	4.8	mA
I_{DDA4}	analog supply current 4 for VCO		5.2	6.5	7.8	mA
I_{DDA5}	analog supply current 5 for on-chip power supply	Europe/US band	–	3.8	–	mA
		Japan/East Europe band	–	7.4	–	mA
I_{DDA6}	analog supply current 6 for on-chip power supply		21.5	27	32.5	mA
$I_{MIX1OUT1}$	bias current of FM mixer output 1		4.8	6	7.2	mA
$I_{MIX1OUT2}$	bias current of FM mixer output 2		4.8	6	7.2	mA
Supply current in AM mode						
I_{DDD}	digital supply current		22	27	32	mA
I_{DDA1}	analog supply current 1 for AM mixer 2		100	120	140	μA
I_{DDA2}	analog supply current 2 for RF		1.4	1.8	2.2	mA
I_{DDA3}	analog supply current 3 for tuning PLL		1.8	2.2	2.6	mA
I_{DDA4}	analog supply current 4 for VCO		5	6.5	8	mA
I_{DDA5}	analog supply current 5 for on-chip power supply		–	11	–	mA
I_{DDA6}	analog supply current 6 for on-chip power supply		14	17.5	21	mA
$I_{MIX1OUT1}$	bias current of AM mixer 1 output 1		4.8	6	7.2	mA
$I_{MIX1OUT2}$	bias current of AM mixer 1 output 2		4.8	6	7.2	mA
$I_{AMMIX2OUT1}$	bias current of AM mixer 2 output 1		3.6	4.5	5.4	mA
$I_{AMMIX2OUT2}$	bias current of AM mixer 2 output 2		3.6	4.5	5.4	mA
On-chip power supply reference current generator: pin IREF						
$V_{O(\text{ref})}$	output reference voltage	$R_{IREF} = 120\text{ k}\Omega$	4	4.25	4.5	V
R_o	output resistance	$R_{IREF} = 120\text{ k}\Omega$	–	10	–	$\text{k}\Omega$
$I_{o(\text{max})}$	maximum output current	$R_{IREF} = 120\text{ k}\Omega$	–100	–	+100	nA

New In Car Entertainment car radio tuner IC with Precision Adjacent Channel Suppression (NICE-PACS)

TEA6849H

11 AC CHARACTERISTICS

$V_{DDA(n)} = V_{MIX1OUT1} = V_{MIX1OUT2} = V_{AMMIX2OUT1} = V_{AMMIX2OUT2} = 8.5\text{ V}$; $V_{DDD} = V_{DDA5} = 5\text{ V}$; $T_{amb} = 25\text{ °C}$; tested in the circuit of Figs 12 and 13; all AC values are given in RMS; unless otherwise specified.

SYMBOL	PARAMETER	CONDITIONS	MIN.	TYP.	MAX.	UNIT
Voltage controlled oscillator						
f_{osc}	oscillator frequency		162.9	–	248.2	MHz
C/N	carrier-to-noise ratio	$f_{osc} = 200\text{ MHz}$; $\Delta f = 10\text{ kHz}$	–	97	–	$\frac{\text{dBc}}{\sqrt{\text{Hz}}}$
RR	ripple rejection $\frac{\Delta f_{osc}}{f_{osc}}$	$f_{ripple} = 100\text{ Hz}$; $V_{DDA4(ripple)} = 100\text{ mV (RMS)}$; $f_{osc} = 200\text{ MHz}$	92	99	–	dB
Crystal oscillator						
f_{xtal}	crystal frequency		–	20.5	–	MHz
C/N	carrier-to-noise ratio	$f_{xtal} = 20.5\text{ MHz}$; $\Delta f = 10\text{ kHz}$	–	112	–	$\frac{\text{dBc}}{\sqrt{\text{Hz}}}$
CIRCUIT INPUTS: PINS XTAL1, XTALGND AND XTAL2						
$V_{o(osc)(rms)}$	oscillator output voltage (RMS value)	note 1	80	100	160	mV
V_{XTAL1}, V_{XTAL2}	DC bias voltage		1.7	2.1	2.5	V
R_i	real part of input impedance	$V_{XTAL1} - V_{XTAL2} = 1\text{ mV}$; note 1	–250	–	–	Ω
C_i	input capacitance	note 1	8	10	12	pF
Synthesizer						
PROGRAMMABLE DIVIDER						
N_{prog}	programmable divider ratio		512	–	32767	
ΔN_{step}	programmable divider step size		–	1	–	
CHARGE PUMP: PIN CPOUT						
$I_{sink(cp1)}$	low charge pump 1 sink current	$0.4\text{ V} < V_{CPOUT} < 7.6\text{ V}$; data byte 3: bit 0 = 0, bit 1 = 1, bit 2 = 1 for FM weather band; $f_{VCO} > f_{ref} \times \text{divider ratio}$	–	300	–	μA
$I_{source(cp1)}$	low charge pump 1 source current	$0.4\text{ V} < V_{CPOUT} < 7.6\text{ V}$; data byte 3: bit 0 = 0, bit 1 = 1, bit 2 = 1 for FM weather band; $f_{VCO} < f_{ref} \times \text{divider ratio}$	–	–300	–	μA
$I_{sink(cp1)h}$	high charge pump 1 sink current	$0.4\text{ V} < V_{CPOUT} < 7.6\text{ V}$; data byte 3: bit 0 = 1, bit 1 = 1, bit 2 = 1; AM stereo mode; VCO divider = 10 (LW and MW); $f_{VCO} > f_{ref} \times \text{divider ratio}$	–	1	–	mA

New In Car Entertainment car radio tuner IC with Precision Adjacent Channel Suppression (NICE-PACS)

TEA6849H

SYMBOL	PARAMETER	CONDITIONS	MIN.	TYP.	MAX.	UNIT
$I_{\text{source(cp1)h}}$	high charge pump 1 source current	$0.4 \text{ V} < V_{\text{CPOUT}} < 7.6 \text{ V}$; data byte 3: bit 0 = 1, bit 1 = 1, bit 2 = 1; AM stereo mode; VCO divider = 10 (LW and MW); $f_{\text{VCO}} < f_{\text{ref}} \times \text{divider ratio}$	–	–1	–	mA
$I_{\text{sink(cp2)}}$	charge pump 2 sink current	$0.3 \text{ V} < V_{\text{CPOUT}} < 7.1 \text{ V}$; data byte 3: bit 0 = 0, bit 1 = 0, bit 2 = 0; FM standard mode; $f_{\text{VCO}} > f_{\text{ref}} \times \text{divider ratio}$	–	130	–	μA
$I_{\text{source(cp2)}}$	charge pump 2 source current	$0.3 \text{ V} < V_{\text{CPOUT}} < 7.1 \text{ V}$; data byte 3: bit 0 = 0, bit 1 = 0, bit 2 = 0; FM standard mode; $f_{\text{VCO}} < f_{\text{ref}} \times \text{divider ratio}$	–	–130	–	μA
CHARGE PUMP: PIN V_{tune}						
$I_{\text{sink(cp3)}}$	charge pump 3 sink current	$0.4 \text{ V} < V_{\text{tune}} < 7.6 \text{ V}$; data byte 3: bit 0 = 0, bit 1 = 0, bit 2 = 0; FM standard mode; $f_{\text{VCO}} > f_{\text{ref}} \times \text{divider ratio}$	–	3	–	mA
$I_{\text{source(cp3)}}$	charge pump 3 source current	$0.4 \text{ V} < V_{\text{tune}} < 7.6 \text{ V}$; data byte 3: bit 0 = 0, bit 1 = 0, bit 2 = 0; FM standard mode; $f_{\text{VCO}} < f_{\text{ref}} \times \text{divider ratio}$	–	–3	–	mA
Antenna Digital Auto Alignment (DAA)						
DAA INPUT: PIN DAAIN						
$I_{\text{bias(cp)}}$	charge pump buffer input bias current	$V_{\text{DAAIN}} = 0.4 \text{ to } 8 \text{ V}$	–10	–	+10	nA
$V_{\text{i(cp)}}$	charge pump buffer input voltage		0	–	8.5	V
DAA OUTPUT: PIN DAAOUT; note 2						
$V_{\text{o(AM)}}$	DAA output voltage in AM mode	$I_{\text{DAAOUT}} < 100 \mu\text{A}$	–	–	0.3	V
$V_{\text{o(FM)}}$	DAA output voltage in FM mode	minimum value; data byte 2 = 10000000; $V_{\text{DAAIN}} = 0.5 \text{ V}$; $V_{\text{DAATD}} = 0.45 \text{ V}$	–	–	0.5	V
		maximum value; data byte 2 = 11111111; $V_{\text{DAAIN}} = 4.7 \text{ V}$; $V_{\text{DAATD}} = 0.45 \text{ V}$	8	–	8.5	V
		$V_{\text{DAAIN}} = 4 \text{ V}$; $V_{\text{DAATD}} = 0.45 \text{ V}$ data byte 2 = 10000000	–	0.65	–	V
		data byte 2 = 11000000	3.8	4	4.2	V
$V_{\text{o(FM)}}$	DAA output voltage in FM mode	$V_{\text{DAAIN}} = 2 \text{ V}$; $V_{\text{DAATD}} = 0.45 \text{ V}$ data byte 2 = 11010101	2.3	2.6	2.9	V
		data byte 2 = 10101010	1.2	1.4	1.6	V

New In Car Entertainment car radio tuner IC with Precision Adjacent Channel Suppression (NICE-PACS)

TEA6849H

SYMBOL	PARAMETER	CONDITIONS	MIN.	TYP.	MAX.	UNIT
$V_{o(n)}$	DAA output noise voltage	data byte 2 = 11000000; FM mode; $V_{DAAIN} = 4\text{ V}$; $V_{DAATD} = 0.45\text{ V}$; $B = 300\text{ Hz to }22\text{ kHz}$	–	30	100	μV
$\Delta V_{o(T)}$	DAA output voltage variation with temperature	$T_{amb} = -40\text{ to }+85\text{ }^\circ\text{C}$; data byte 2 = 11000000	–8	–	+8	mV
$\Delta V_{o(step)}$	DAA step accuracy	$n = 0\text{ to }127$; FM mode; $V_{DAAOUT} = 0.5\text{ to }8\text{ V}$; $V_{DAAIN} = 2\text{ V}$; $V_{DAATD} = 0.45\text{ V}$	$0.5V_{LSB}$	V_{LSB}	$1.5V_{LSB}$	mV
$\Delta V_{o(sink)}$	DAA output variation caused by sink current	$V_{DAAIN} = 4\text{ V}$; $I_L = 50\text{ }\mu\text{A}$	$-V_{LSB}$	–	$+V_{LSB}$	
$\Delta V_{o(source)}$	DAA output variation caused by source current	$V_{DAAIN} = 4\text{ V}$; $I_L = -50\text{ }\mu\text{A}$	$-V_{LSB}$	–	$+V_{LSB}$	
t_{st}	DAA output settling time	$V_{DAAOUT} = 0.2\text{ to }8.25\text{ V}$; $C_L = 270\text{ pF}$	–	20	30	μs
RR	ripple rejection $\frac{V_{DAAOUT}}{V_{DDA3}}$	data byte 2 = 10101011; FM mode; $V_{DAAIN} = 4\text{ V}$; $V_{DAATD} = 0.45\text{ V}$; $f_{ripple} = 100\text{ Hz}$; $V_{DDA3(ripple)} = 100\text{ mV (RMS)}$	–	65	–	dB
C_L	DAA output load capacitance		–	–	270	pF
DAA TEMPERATURE COMPENSATION: PIN DAATD						
I_{source}	compensation diode source current	$V_{DAATD} = 0.2\text{ to }1.2\text{ V}$	–50	–40	–30	μA
TC_{source}	temperature coefficient of compensation diode source current	$V_{DAATD} = 0.2\text{ to }1.2\text{ V}$; $T_{amb} = -40\text{ to }+85\text{ }^\circ\text{C}$	–300	–	+300	$\frac{10^{-6}}{\text{K}}$
IF counter (FM IF2 or AM IF2 counter)						
N_{IF}	IF counter length for AM and FM		–	8	–	bit
PINS FMMIX2IN AND FMMIX2DEC; note 3						
$V_{sens(rms)}$	sensitivity voltage (RMS value)	FM mode	–	30	100	μV
N	counter result (decimal)	period = 2 ms; $V_{FMMIX2IN-FMMIX2DEC} = 100\text{ }\mu\text{V}$ prescaler ratio = 10	–	90	–	
		prescaler ratio = 40	–	22	–	
		period = 20 ms; $V_{FMMIX2IN-FMMIX2DEC} = 100\text{ }\mu\text{V}$ prescaler ratio = 10	–	132	–	
		prescaler ratio = 40	–	225	–	

New In Car Entertainment car radio tuner IC with Precision Adjacent Channel Suppression (NICE-PACS)

TEA6849H

SYMBOL	PARAMETER	CONDITIONS	MIN.	TYP.	MAX.	UNIT
PINS AMIF2IN AND AMIF2DEC; note 4						
$V_{\text{sens(rms)}}$	sensitivity voltage (RMS value)	AM mode; $m = 0$	–	30	70	μV
N	counter result (decimal)	period = 2 ms; $V_{\text{AMIF2IN-AMIF2DEC}} = 200 \mu\text{V}$	–	132	–	
		period = 20 ms; $V_{\text{AMIF2IN-AMIF2DEC}} = 200 \mu\text{V}$	–	40	–	
Reference frequency for car signal processor IC TEA688x and TEF689x; note 5						
REFERENCE FREQUENCY DIVIDER						
N_{ref}	crystal oscillator divider ratio		–	272	–	
f_{ref}	reference frequency	$f_{\text{xtal}} = 20.5 \text{ MHz}$	–	75.368	–	kHz
VOLTAGE GENERATOR: PIN FREF						
$V_{\text{o(p-p)}}$	AC output voltage (peak-to-peak value)	not loaded	60	90	–	mV
V_{O}	DC output voltage		3.2	3.4	3.7	V
R_{O}	output resistance		–	–	50	$\text{k}\Omega$
$R_{\text{L(min)}}$	minimum load resistance for first I ² C-bus address		1	–	–	$\text{M}\Omega$
Weather band flag: pin WBFLAG						
$I_{\text{source(max)}}$	maximum source current		–	–5	–	mA
$R_{\text{i(shunt)}}$	internal shunt resistance to ground		–	50	–	$\text{k}\Omega$
$V_{\text{o(max)}}$	maximum output voltage for FM mode	measured with respect to pin RFGND	0	–	0.2	V
V_{O}	output voltage for weather band mode	measured with respect to pin RFGND	4	–	5	V
AM signal channel						
AM RF AGC STAGE (PIN DIODE DRIVE)						
$V_{\text{i(p)}}$	RF input voltage for wideband AGC start level (peak value)	$m = 0.3$; data byte 4: bit 5 = 0, bit 6 = 0	–	150	–	mV
		$m = 0.3$; data byte 4: bit 5 = 1, bit 6 = 0	–	275	–	mV
		$m = 0.3$; data byte 4: bit 5 = 0, bit 6 = 1	–	400	–	mV
		$m = 0.3$; data byte 4: bit 5 = 1, bit 6 = 1	–	525	–	mV
AM IF AGC STAGE INPUT: PIN AMIF2IN						
$V_{\text{i(p)}}$	IF2 input voltage (peak value)	AGC start level	0.20	0.27	0.35	V

New In Car Entertainment car radio tuner IC with Precision Adjacent Channel Suppression (NICE-PACS)

TEA6849H

SYMBOL	PARAMETER	CONDITIONS	MIN.	TYP.	MAX.	UNIT
AM RF AGC CURRENT GENERATOR OUTPUT: PIN IAMAGC						
$I_{\text{sink(max)}}$	maximum AGC sink current	$V_o = 2.8 \text{ V}$	11	15	19	mA
I_{sink}	AGC sink current	FM mode	1	–	–	mA
R_o	output resistance	$I_o = 1 \mu\text{A}$	0.5	–	–	M Ω
C_o	AM AGC current generator output capacitance		–	5	7	pF
RF CASCODE AGC						
$I_{\text{cas(off)}}$	AM cascode off current	FM mode	–	–	100	nA
Pin VAMCASFB						
$V_{\text{cas(FB)}}$	cascode feedback voltage	$V_{\text{AMMIX1IN-AMMIX1DEC}}$ above threshold; minimum gain	–	0.26	–	V
$I_{\text{cas(FB)}}$	cascode feedback sense current		0	–	1	μA
Pin VAMCAS						
V_{cas}	cascode voltage	$V_{\text{AMMIX1IN-AMMIX1DEC}}$ below threshold; maximum gain	–	5	–	V
I_{cas}	cascode transistor base current capability		100	–	–	μA
AM MIXER 1 (IF1 = 10.7 MHz)						
Mixer inputs: pins AMMIX1DEC and AMMIX1IN						
R_i	input resistance	note 6	15	25	40	k Ω
C_i	input capacitance	note 6	2.5	5	7.5	pF
V_i	DC input voltage		2.3	2.7	3.1	V
$V_{i(\text{max})}$	maximum input voltage	1 dB compression point of $V_{\text{MIX1OUT1-MIX1OUT2}}$; $m = 0$	500	–	–	mV
Mixer outputs: pins MIX1OUT1 and MIX1OUT2						
R_o	output resistance	note 7	100	–	–	k Ω
C_o	output capacitance	note 7	–	4	7	pF
$V_{o(\text{max})(\text{p-p})}$	maximum output voltage (peak-to-peak value)		12	15	–	V
I_{bias}	mixer bias current	AM mode	4.8	6	7.2	mA
Mixer						
$g_{m(\text{conv})}$	conversion transconductance $\frac{I_{\text{MIX1OUT}}}{V_{\text{MIX1IN}}}$		2.0	2.55	3.2	$\frac{\text{mA}}{\text{V}}$

New In Car Entertainment car radio tuner IC with Precision Adjacent Channel Suppression (NICE-PACS)

TEA6849H

SYMBOL	PARAMETER	CONDITIONS	MIN.	TYP.	MAX.	UNIT
$g_{m(\text{conv})(T)}$	conversion transconductance variation with temperature $\frac{\Delta g_{m(\text{conv})}}{g_{m(\text{conv})} \times \Delta T}$		–	-9×10^{-4}	–	K^{-1}
IP3	3rd-order intermodulation	$R_L = 2.6 \text{ k}\Omega$ (AC load between output pins); $\Delta f = 300 \text{ kHz}$	135	138	–	$\text{dB}\mu\text{V}$
IP2	2nd-order intermodulation	$R_L = 2.6 \text{ k}\Omega$ (AC load between output pins)	–	170	–	$\text{dB}\mu\text{V}$
$V_{i(n)(\text{eq})}$	equivalent input noise voltage	band limited noise; $R_{\text{gen}} = 750 \text{ }\Omega$; $R_L = 2.6 \text{ k}\Omega$ (AC load between output pins)	–	5.8	8	$\frac{\text{nV}}{\sqrt{\text{Hz}}}$
F	noise figure of AM mixer 1		–	4.5	7.1	dB
AM MIXER 2 (IF2 = 450 kHz)						
<i>Mixer inputs: pins IFAMPIN and IFAMPDEC</i>						
R_i	input resistance	note 8	–	330	–	Ω
C_i	input capacitance	note 8	–	5	7	pF
V_I	DC voltage		2.4	2.7	3	V
$V_{i(\text{max})(\text{p})}$	maximum input voltage (peak value)	1 dB compression point of $V_{\text{AMMIX2OUT1-AMMIX2OUT2}}$	1.1	1.4	–	V
<i>Mixer outputs: pins AMMIX2OUT1 and AMMIX2OUT2</i>						
R_o	output resistance	note 9	50	–	–	$\text{k}\Omega$
C_o	output capacitance	note 9	–	4	7	pF
$V_{o(\text{max})(\text{p-p})}$	maximum output voltage (peak-to-peak value)	$V_{\text{DDA6}} = 8.5 \text{ V}$	12	15	–	V
I_{bias}	mixer bias current	AM mode	3.6	4.5	5.4	mA
<i>Mixer</i>						
$g_{m(\text{conv})}$	conversion transconductance $\frac{I_{\text{AMMIX2OUT}}}{V_{\text{IFAMPIN}}}$		1.3	1.6	1.9	$\frac{\text{mA}}{\text{V}}$
$g_{m(\text{conv})(T)}$	conversion transconductance variation with temperature $\frac{\Delta g_{m(\text{conv})}}{g_{m(\text{conv})} \times \Delta T}$		–	-9×10^{-4}	–	K^{-1}
IP3	3rd-order intermodulation	$R_L = 1.5 \text{ k}\Omega$ (AC load between output pins); $\Delta f = 300 \text{ kHz}$	134	137	–	$\text{dB}\mu\text{V}$
IP2	2nd-order intermodulation	$R_L = 1.5 \text{ k}\Omega$ (AC load between output pins)	–	170	–	$\text{dB}\mu\text{V}$
$V_{i(n)(\text{eq})}$	equivalent input noise voltage	$R_{\text{gen}} = 330 \text{ }\Omega$; $R_L = 1.5 \text{ k}\Omega$ (AC load between output pins)	–	15	22	$\frac{\text{nV}}{\sqrt{\text{Hz}}}$

New In Car Entertainment car radio tuner IC with Precision Adjacent Channel Suppression (NICE-PACS)

TEA6849H

SYMBOL	PARAMETER	CONDITIONS	MIN.	TYP.	MAX.	UNIT
F	noise figure of AM mixer 2		–	16	19.5	dB
I_L	mixer leakage current	FM mode	–	–	10	μ A
AM IF2 AGC STAGE: PINS AMIF2IN AND AMIF2DEC; note 4						
V_i	input voltage	audio attenuation $\alpha = -10$ dB	–	25	40	μ V
		data byte 4: bit 4 = 1; mute on data byte 4: bit 4 = 0; mute off	–	6	10	μ V
$V_{AGC(start)}$	AGC start voltage	input carrier voltage	–	14	30	μ V
$V_{AGC(stop)}$	AGC stop voltage	maximum input peak voltage	1	–	–	V
$V_{AGC(ctrl)}$	AGC control voltage	$V_i = 1$ mV	4.1	4.3	4.7	V
ΔAGC	AGC range	between start and stop of AGC	–	89	–	dB
R_i	input resistance		1.8	2	2.2	k Ω
C_i	input capacitance		–	10	15	pF
AM DETECTOR						
$V_{sens(rms)}$	sensitivity voltage (RMS value)	$m = 0.3$; $f_{mod} = 400$ Hz; $B_{AF} = 2.15$ kHz; $R_{gen} = 2$ k Ω ; note 4	–	45	65	μ V
		(S+N)/N = 26 dB (S+N)/N = 46 dB	–	600	900	μ V
(S+N)/N	maximum signal plus noise-to-noise ratio	$m = 0.3$; $f_{mod} = 400$ Hz; $B_{AF} = 2.15$ kHz; $R_{gen} = 2$ k Ω	–	60	–	dB
THD	total harmonic distortion	$B_{AF} = 2.15$ kHz; $C_{AGC} = 10$ μ F; $V_{AMIF2IN} = 100$ μ V to 250 mV (RMS)	–	–	–	–
		$m = 0.8$; $f_{mod} = 400$ Hz	–	0.5	1	%
		$m = 0.8$; $f_{mod} = 100$ Hz	–	1.25	2.5	%
t_{sw}	FM to AM switching time	$V_{AMIF2IN} = 100$ μ V; $C_{AGC} = 10$ μ F	–	1000	1500	ms
t_{st}	AM AGC settling time	$V_{AMIF2IN} = 100$ μ V to 100 mV	–	400	600	ms
		$V_{AMIF2IN} = 100$ mV to 100 μ V	–	600	900	ms
<i>Output: pin AMAFIF2</i>						
$V_{o(rms)}$	AM IF2 output voltage (RMS value)	AM stereo; $m = 0$; data byte 3: bit 0 = 1, bit 1 = 1, bit 2 = 1	–	–	–	–
		minimum $V_{AMIF2IN} = 14$ μ V	1.5	3	4.5	mV
		maximum $V_{AMIF2IN} = 5$ mV	130	180	230	mV
		AM mono; $m = 0.3$; data byte 3: bit 0 = 1, bit 1 = 0, bit 2 = 1; $f_{mod} = 400$ Hz; $V_{AMIF2IN} = 100$ μ V to 500 mV (RMS)	200	250	300	mV
R_o	output resistance	data byte 3: bit 0 = 1, bit 1 = 1, bit 2 = 1; AM stereo	–	–	500	Ω
		data byte 3: bit 0 = 1, bit 1 = 0, bit 2 = 1; AM mono	–	–	500	Ω

New In Car Entertainment car radio tuner IC with Precision Adjacent Channel Suppression (NICE-PACS)

TEA6849H

SYMBOL	PARAMETER	CONDITIONS	MIN.	TYP.	MAX.	UNIT
C _o	output capacitance	data byte 3: bit 0 = 1, bit 1 = 0, bit 2 = 1	–	5	7	pF
Z _L	load impedance	data byte 3: bit 0 = 1, bit 1 = 0, bit 2 = 1; AM mono	100	–	–	kΩ
		data byte 3: bit 0 = 1, bit 1 = 1, bit 2 = 1; AM stereo	10	–	–	kΩ
RR	ripple rejection	V _{DDA5(ripple)} = 100 mV (RMS); f _{ripple} = 100 Hz	–	24	–	dB
		V _{DDA6(ripple)} = 100 mV (RMS); f _{ripple} = 100 Hz	–	26	–	dB
AM IF2 LEVEL DETECTOR OUTPUT: PIN V _{level(AMFM)} ; see Fig.4						
V _{level(AMFM)}	DC output voltage	V _{AMIF2IN} = 10 μV to 1 V	0	–	7	V
		V _{AMIF2IN} < 1 μV; standard setting of level DAA	0.1	0.5	0.9	V
		V _{AMIF2IN} = 1.4 mV; standard setting of level DAA	1.6	2.2	2.8	V
ΔV _{level(AMFM)}	step size for adjustment of level starting point	V _{AMIF2IN} = 0 V; standard setting of level slope	30	40	50	mV
V _{level(slope)}	slope of level voltage	V _{AMIF2IN} = 140 μV to 140 mV; standard setting of level slope	650	800	950	$\frac{\text{mV}}{20 \text{ dB}}$
ΔV _{step}	step size for adjustment of level slope	V _{AMIF2IN} = 1.4 mV	45	60	75	$\frac{\text{mV}}{20 \text{ dB}}$
B _{level(AMFM)}	bandwidth of level output voltage	V _{AMIF2IN} = 15 mV; standard setting of level DAA	200	300	–	kHz
R _o	output resistance		–	–	500	Ω
RR	ripple rejection $\frac{V_{\text{level}}}{V_{\text{DDA6}}}$	V _{DDA6(ripple)} = 100 mV (RMS); f _{ripple} = 100 Hz	–	36	–	dB
AM NOISE BLANKER; TEST SIGNAL AND TEST CIRCUIT; see Fig.5						
<i>Threshold: pin AMNBHOLD</i>						
V _O	DC output voltage		4.3	4.6	5.1	V
t _{sup}	suppression time	V _{pulse} = 200 mV (peak); V _{level(AMFM)} < 1.8 V	6	7.5	10	μs
f _{trigger}	trigger sensitivity frequency	V _{pulse} = 200 mV (peak); V _{level(AMFM)} < 1.8 V	–	1000	–	Hz
		V _{pulse} = 200 mV (peak); V _{level(AMFM)} > 2.2 V	–	–	100	Hz
		V _{pulse} = 20 mV (peak); V _{level(AMFM)} < 1.8 V	–	–	100	Hz
<i>Noise detector output: pin TRDSMUTE</i>						
I _{sink(AGC)}	AM noise blanker AGC sink current	V _{TRDSMUTE} = 3 V	35	50	65	μA

New In Car Entertainment car radio tuner IC with Precision Adjacent Channel Suppression (NICE-PACS)

TEA6849H

SYMBOL	PARAMETER	CONDITIONS	MIN.	TYP.	MAX.	UNIT
V_{AGC}	AM noise blanker AGC voltage	AM mixer 1 input $V_i = 0$ V	1.9	2.2	2.5	V
FM signal channel						
FM RF AGC (FM DISTANCE MODE; DATA BYTE 4: BIT 3 = 0)						
<i>Inputs: pins FMMIXIN1 and FMMIXIN2; note 10</i>						
$V_{i(RF)(rms)}$	RF input voltage for start of wideband AGC (RMS value)	data byte 4: bit 5 = 1, bit 6 = 1	–	3	–	mV
		data byte 4: bit 5 = 0, bit 6 = 1	–	6	–	mV
		data byte 4: bit 5 = 1, bit 6 = 0	–	9	–	mV
		data byte 4: bit 5 = 0, bit 6 = 0	–	12	–	mV
<i>Pin TFMAGC</i>						
R_{source}	source resistance		4	5	6	k Ω
$V_{O(ref)}$	DC output reference voltage	data byte 4: bit 5 = 0, bit 6 = 0; $V_{FMMIXIN1-FMMIXIN2} = 0$ V	4.1	4.6	5.1	V
<i>PIN diode drive output: pin IFMAGC</i>						
$I_{sink(AGC)(max)}$	maximum AGC sink current	$V_{IFMAGC} = 2.5$ V; $V_{TFMAGC} = V_{O(ref)} - 0.5$ V; data byte 4: bit 5 = 0, bit 6 = 0, bit 7 = 0	8	11.5	15	mA
$I_{source(AGC)(max)}$	maximum AGC source current	$V_{IFMAGC} = 2.5$ V; $V_{TFMAGC} = V_{O(ref)} + 0.5$ V; data byte 4: bit 5 = 0, bit 6 = 0, bit 7 = 0	–15	–11.5	–8	mA
$I_{source(AGC)}$	AGC source current	AM mode	–15	–11.5	–8	mA
		$V_{IFMAGC} = 2.5$ V; data byte 4: bit 3 = 1 (FM local)	–1.4	–1.1	–0.8	mA
<i>Level voltage output: pin $V_{level(AMFM)}$</i>						
V_{th}	threshold voltage for narrow-band AGC	data byte 4: bit 5 = 0, bit 6 = 0, bit 7 = 1; keyed AGC	500	950	1400	mV
FM RF MIXER						
<i>Reference voltage: pin $V_{ref(MIX)}$</i>						
V_{ref}	reference voltage	FM mode	6.5	7.1	7.9	V
		AM mode	2.7	3.1	3.4	V
<i>Inputs: pins FMMIXIN1 and FMMIXIN2; note 10</i>						
$V_{i(RF)(max)}$	maximum RF input voltage	1 dB compression point of FM mixer output voltage (peak-to-peak value)	70	100	–	mV
$V_{i(n)(eq)}$	equivalent input noise voltage	$R_{gen} = 200$ Ω ; $R_L = 2.6$ k Ω	–	2.6	3.1	$\frac{nV}{\sqrt{Hz}}$
R_i	input resistance		1.4	2.8	4.2	k Ω
C_i	input capacitance		–	5	7	pF

New In Car Entertainment car radio tuner IC with Precision Adjacent Channel Suppression (NICE-PACS)

TEA6849H

SYMBOL	PARAMETER	CONDITIONS	MIN.	TYP.	MAX.	UNIT
<i>Outputs: pins MIX1OUT1 and MIX1OUT2; note 7</i>						
R _o	output resistance		100	–	–	kΩ
C _o	output capacitance		2	3.5	5	pF
I _{bias}	mixer bias current	FM mode	4.8	6	7.2	mA
V _{o(max)(p-p)}	maximum output voltage (peak-to-peak value)		3	–	–	V
<i>FM mixer</i>						
g _{m(conv)}	conversion transconductance		8.5	12.5	18	$\frac{\text{mA}}{\text{V}}$
g _{m(conv)(T)}	conversion transconductance variation with temperature		–	-1×10^{-3}	–	K ⁻¹
F	noise figure		–	3	4.6	dB
R _{gen(opt)}	optimum generator resistance		–	200	–	Ω
IP3	3rd-order intermodulation		113	116	–	dBμV
IRR	image rejection ratio $\frac{V_{\text{MIX1OUTwanted}}}{V_{\text{MIX1OUTimage}}}$	f _{RFwanted} = 87.5 MHz; f _{RFimage} = 108.9 MHz	25	30	–	dB
		data byte 3 = X010X110; f _{RFwanted} = 162.475 MHz; f _{RFimage} = 183.875 MHz; weather band mode; f _{ref} = 25 kHz	22	30	–	dB
<i>IF AMPLIFIER</i>						
G	gain	R _L = 330 Ω; V _{IFAMPIN} = 1 mV; note 8	15	17	19	dB
F	noise figure		–	10	13	dB
IP3	3rd-order intermodulation		113	116	–	dBμV
<i>Inputs: pins IFAMPIN and IFAMPDEC; note 8</i>						
V _{i(max)(p)}	maximum input voltage (peak value)	1 dB compression point of IF amplifier output voltage (peak value)	200	–	–	mV
V _{i(n)(eq)}	equivalent input noise voltage	R _{gen} = 330 Ω; R _L = 330 Ω	–	8	10	$\frac{\text{nV}}{\sqrt{\text{Hz}}}$
R _i	input resistance		270	330	390	Ω
C _i	input capacitance		–	5	7	pF
<i>Output: pin IFAMPOUT</i>						
V _{o(max)(p)}	maximum output voltage (peak value)		1.2	1.5	–	V
R _o	output resistance		270	330	390	Ω
C _o	output capacitance		–	5	7	pF

New In Car Entertainment car radio tuner IC with Precision Adjacent Channel Suppression (NICE-PACS)

TEA6849H

SYMBOL	PARAMETER	CONDITIONS	MIN.	TYP.	MAX.	UNIT
Tunable filter						
B _{max}	maximum bandwidth	data byte 4: bit 1 = 0, bit 0 = 0; dynamic mode	–	160	–	kHz
B _{min}	minimum bandwidth	data byte 4: bit 1 = 0, bit 0 = 0; dynamic mode; V _{TACD} = 4.2 V	–	25	–	kHz
B ₁₃	bandwidth in weather band mode		–	13	–	kHz
B ₆₀	bandwidth in narrow band mode	data byte 4: bit 1 = 1, bit 0 = 1	–	60	–	kHz
B ₉₀	bandwidth in mid band mode	data byte 4: bit 1 = 1, bit 0 = 0	–	90	–	kHz
B ₁₃₀	bandwidth in wideband mode	data byte 4: bit 1 = 0, bit 0 = 1	–	130	–	kHz
PIN V _{IFBW}						
V _o	monitor output voltage for IF2 bandwidth	fixed bandwidth = narrow	–	1.35	–	V
		fixed bandwidth = mid	–	0.94	–	V
		fixed bandwidth = wide	–	0.55	–	V
R _o	output resistance		–	5	–	kΩ
Adjacent channel detector						
MODULATION DETECTOR INPUT: PIN MODDET						
R _i	input resistance		–	40	–	kΩ
C _i	input capacitance		–	5	7	pF
MODULATION DETECTOR OUTPUT: PIN MODETOUT						
R _o	output resistance		–	32	–	kΩ
DETECTOR ADJUST: PIN ACDTHRES						
R _i	input resistance		10	–	–	MΩ
C _i	input capacitance		–	5	7	pF
FM demodulator and level detector; see Figs 6 and 7						
FM DEMODULATOR						
<i>FM mixer 2 input: pins FMMIX2IN and FMMIX2DEC; note 3</i>						
V _{start(lim)(rms)}	start of limiting of RDS MPX output voltage (RMS value)	α _{AF} = –3 dB	–	4.5	–	μV
V _{o(sens)(rms)}	sensitivity for RDS MPX output voltage (RMS value)	Δf = 22.5 kHz; f _{mod} = 1 kHz; de-emphasis = 50 μs	–	11	–	μV
		R _{gen} = 165 Ω; (S+N)/N = 26 dB	–	90	–	μV
		(S+N)/N = 46 dB	–	90	–	μV

New In Car Entertainment car radio tuner IC with Precision Adjacent Channel Suppression (NICE-PACS)

TEA6849H

SYMBOL	PARAMETER	CONDITIONS	MIN.	TYP.	MAX.	UNIT
<i>RDS MPX output: pin RDSMPX</i>						
(S+N)/N	maximum signal plus noise-to-noise ratio of RDS MPX output voltage	$\Delta f = 22.5 \text{ kHz}; f_{\text{mod}} = 1 \text{ kHz};$ de-emphasis = 50 $\mu\text{s};$ $V_{\text{FMMIX2IN}} = 10 \text{ mV}$	65	68	–	dB
THD	total harmonic distortion of RDS MPX output voltage	$\Delta f = 75 \text{ kHz}; f_{\text{mod}} = 1 \text{ kHz};$ de-emphasis = 50 $\mu\text{s};$ $V_{\text{FMMIX2IN}} = 200 \mu\text{V to } 800 \text{ mV}$	–	0.35	0.7	%
α_{AM}	AM suppression $\frac{V_{\text{o(rms)}}}{V_{\text{o(AM)(rms)}}$	FM: $\Delta f = 22.5 \text{ kHz}; f_{\text{mod}} = 1 \text{ kHz};$ AM: $m = 0.3; f_{\text{mod}} = 1 \text{ kHz};$ de-emphasis = 50 μs $V_{\text{FMMIX2IN}} = 30 \text{ to } 70 \mu\text{V}$	20	30	–	dB
		$V_{\text{FMMIX2IN}} = 70 \text{ to } 500 \mu\text{V}$	30	40	–	dB
		$V_{\text{FMMIX2IN}} = 500 \mu\text{V to } 300 \text{ mV}$	35	45	–	dB
		$V_{\text{FMMIX2IN}} = 300 \text{ mV to } 1 \text{ V}$	30	40	–	dB
$V_{\text{o(rms)}}$	RDS MPX output voltage (RMS value)	$V_{\text{FMMIX2IN}} = 20 \mu\text{V to } 1 \text{ V};$ note 3 $\Delta f = 5 \text{ kHz}; f_{\text{mod}} = 57 \text{ kHz}$	45	50	55	mV
		$\Delta f = 22.5 \text{ kHz}; f_{\text{mod}} = 1 \text{ kHz}$	205	230	255	mV
$I_{\text{o(max)(rms)}}$	maximum RDS MPX output current (RMS value)		100	–	–	μA
R_{o}	output resistance		–	–	500	Ω
R_{L}	load resistance		20	–	–	k Ω
C_{L}	load capacitance		–	–	50	pF
B	bandwidth RDS MPX output	$C_{\text{L}} = 0; R_{\text{L}} > 20 \text{ k}\Omega$	200	300	–	kHz
PSRR	power supply ripple rejection	$f_{\text{ripple}} = 100 \text{ Hz to } 20 \text{ kHz}$	–	40	–	dB
<i>FM MPX output: pin FMMPX; note 3</i>						
(S+N)/N	maximum signal plus noise-to-noise ratio of FM MPX output voltage	$\Delta f = 22.5 \text{ kHz}; f_{\text{mod}} = 1 \text{ kHz};$ de-emphasis = 50 $\mu\text{s};$ $V_{\text{FMMIX2IN}} = 10 \text{ mV}$	65	68	–	dB
THD	total harmonic distortion of FM MPX output voltage	$\Delta f = 75 \text{ kHz}; f_{\text{mod}} = 1 \text{ kHz};$ de-emphasis = 50 $\mu\text{s};$ $V_{\text{FMMIX2IN}} = 200 \mu\text{V to } 800 \text{ mV}$	–	0.1	–	%
α_{AM}	AM suppression $\frac{V_{\text{o(rms)}}}{V_{\text{o(AM)(rms)}}$	FM: $\Delta f = 22.5 \text{ kHz}; f_{\text{mod}} = 1 \text{ kHz};$ AM: $m = 0.3; f_{\text{mod}} = 1 \text{ kHz};$ de-emphasis = 50 μs $V_{\text{FMMIX2IN}} = 30 \text{ to } 70 \mu\text{V}$	20	30	–	dB
		$V_{\text{FMMIX2IN}} = 70 \text{ to } 500 \mu\text{V}$	30	40	–	dB
		$V_{\text{FMMIX2IN}} = 500 \mu\text{V to } 300 \text{ mV}$	35	45	–	dB
		$V_{\text{FMMIX2IN}} = 300 \text{ mV to } 1 \text{ V}$	30	40	–	dB

New In Car Entertainment car radio tuner IC with Precision Adjacent Channel Suppression (NICE-PACS)

TEA6849H

SYMBOL	PARAMETER	CONDITIONS	MIN.	TYP.	MAX.	UNIT
$V_{o(rms)}$	FM MPX output voltage (RMS value)	$\Delta f = 22.5 \text{ kHz}; f_{mod} = 1 \text{ kHz}; V_{FMMIX2IN} = 20 \mu\text{V to } 1 \text{ V}$	205	230	255	mV
		$\Delta f = 1.5 \text{ kHz}; f_{mod} = 1 \text{ kHz}; V_{FMMIX2IN} = 20 \mu\text{V to } 1 \text{ V};$ weather band mode	150	230	310	mV
$I_{o(max)}$	maximum FM MPX output current		100	–	–	μA
B	bandwidth FM MPX output	$C_L = 0; R_L > 20 \text{ k}\Omega$	200	–	–	kHz
PSRR	power supply ripple rejection	$f_{ripple} = 100 \text{ Hz to } 20 \text{ kHz}$	–	40	–	dB
R_L	load resistance		20	–	–	$\text{k}\Omega$
R_o	output resistance		–	–	500	Ω
C_L	load capacitance		–	–	50	pF
t_{sw}	AM to FM switching time	$V_{FMMIX2IN} = 100 \mu\text{V}$	–	100	150	ms
MPX mute						
α_{mute}	muting depth	data byte 2: bit 7 = 1 (mute)	60	80	–	dB
$V_{offset(DC)}$	DC offset during RDS update mute pin FMMPX $\Delta V = V_{muted} - V_{notmuted}$		–30	–	+30	mV
RDS update: pin TRDSMUTE						
$V_{TRDSMUTE}$	voltage at pin TRDSMUTE	no mute	5.2	5.7	6.2	V
		mute	0.7	1.2	1.7	V
I_{dch}	discharge current	$V_o = 3 \text{ V};$ data byte 2: bit 7 = 1	24	32	38	μA
I_{ch}	charge current	$V_o = 3 \text{ V};$ data byte 2: bit 7 = 0	–38	–32	–24	μA
FM MPX SOFT MUTE: PIN IF2FILQ; note 3						
V_{mute}	mute voltage	$V_{FMMIX2IN} = 0 \text{ to } 1 \text{ V}$	0	–	3	V
V_{offset}	voltage offset (to $V_{level(AMFM)}$)	$V_{FMMIX2IN} = 0 \text{ to } 100 \mu\text{V}$	–200	–	+200	mV
I_{dch}	discharge current	$V_{level(AMFM)} < V_i$	2.5	3.5	4.5	μA
I_{ch}	charge current	$V_{level(AMFM)} > V_i$	–4.5	–3.5	–2.5	μA
α_{mute}	mute attenuation	$V_{FMMIX2IN} = 10 \text{ mV}; V_i = 400 \text{ mV};$ data byte 7 = X1000100	–	7.5	–	dB
$\Delta\alpha_{mute}$	difference to mute attenuation from step to step	$V_{FMMIX2IN} = 10 \text{ mV}; V_i = 400 \text{ mV}$ data byte 7 = X1001100	–	0.9	–	dB
		data byte 7 = X1010100	–	2.5	–	dB
		data byte 7 = X1011100	–	3.4	–	dB
		data byte 7 = X1100100	–	8.7	–	dB
		data byte 7 = X1101100	–	4.4	–	dB
		data byte 7 = X1110100	–	8.5	–	dB
		data byte 7 = X1111100	–	5.5	–	dB
$\alpha_{mute(off)}$	mute off	$V_{FMMIX2IN} = 10 \text{ mV}; V_i = 400 \text{ mV};$ data byte 7 = X0111100	–1	0	+1	dB

New In Car Entertainment car radio tuner IC with Precision Adjacent Channel Suppression (NICE-PACS)

TEA6849H

SYMBOL	PARAMETER	CONDITIONS	MIN.	TYP.	MAX.	UNIT
$\alpha_{\text{mute(max)}}$	maximum mute attenuation	$V_{\text{FMMIX2IN}} = 10 \text{ mV}$; $V_i = 10 \text{ mV}$; data byte 7 = X1111100	36	42.5	50	dB
$V_{\text{mute(start)}}$	mute start voltage	$\alpha_{\text{mute}} = -3 \text{ dB}$; $V_{\text{FMMIX2IN}} = 10 \text{ mV}$; data byte 7 = X1111000	410	480	550	mV
$\Delta V_{\text{mute(start)}}$	difference to mute start voltage from step to step	$\alpha_{\text{mute}} = -3 \text{ dB}$; $V_{\text{FMMIX2IN}} = 10 \text{ mV}$ data byte 7 = X1111001 data byte 7 = X1111010 data byte 7 = X1111011 data byte 7 = X1111100 data byte 7 = X1111101 data byte 7 = X1111110 data byte 7 = X1111111	80	93	105	mV
$V_{\text{offset(DC)}}$	DC offset created by soft mute pin FMMPX $\Delta V = V_{\text{muted}} - V_{\text{notmuted}}$	data byte 7 = X1111111; $V_{\text{FMMIX2IN}} = 10 \text{ mV}$; $f_{\text{IF}} = 10.7 \text{ MHz}$; unmodulated; $V_i = 1.9 \text{ V}$ versus 0.4 V	-30	-	+30	mV
FM IF LEVEL DETECTOR OUTPUT: PIN $V_{\text{level(AMFM)}}$; note 3						
$V_{\text{level(AMFM)}}$	DC output voltage	$V_{\text{FMMIX2IN}} = 10 \text{ } \mu\text{V}$ to 1 V	0	-	7	V
		$V_{\text{FMMIX2IN}} < 1 \text{ } \mu\text{V}$; standard setting of level DAA	0.1	0.35	0.9	V
		$V_{\text{FMMIX2IN}} = 1 \text{ mV}$; standard setting of level DAA	1	1.5	2.1	V
$\Delta V_{\text{level(AMFM)}}$	step size of starting point adjustment	data byte 5: bit 2 = 1, bit 1 = 0, bit 0 = 0	30	40	50	mV
$V_{\text{level(slope)}}$	slope of level voltage $\frac{\Delta V_{\text{level(AMFM)}}}{\Delta V_{\text{FMMIX2IN}}}$	$V_{\text{FMMIX2IN}} = 1$ to 300 mV ; standard setting of level slope	650	800	950	$\frac{\text{mV}}{20 \text{ dB}}$
ΔV_{step}	step size of slope adjustment	$V_{\text{FMMIX2IN}} = 1 \text{ mV}$	45	60	75	$\frac{\text{mV}}{20 \text{ dB}}$
$B_{\text{level(AMFM)}}$	bandwidth of level output voltage	$V_{\text{FMMIX2IN}} = 10 \text{ mV}$; standard setting of level DAA	200	300	-	kHz
I_{source}	output source current		-	-	-300	μA
I_{sink}	output sink current		50	-	-	μA
R_o	output resistance		-	-	500	Ω
RR	ripple rejection	$f_{\text{ripple}} = 100 \text{ Hz}$; $V_{\text{DDA6(ripple)}} = 100 \text{ mV (RMS)}$	-	40	-	dB
PIN $V_{\text{level(ACD)}}$						
R_o	output resistance		6.4	8	9.6	k Ω

New In Car Entertainment car radio tuner IC with Precision Adjacent Channel Suppression (NICE-PACS)

TEA6849H

SYMBOL	PARAMETER	CONDITIONS	MIN.	TYP.	MAX.	UNIT
RDS update						
<i>Output: pin AFHOLD</i>						
$I_{\text{sink(max)}}$	maximum sink current	after first bus transmission with data byte 0: bit 7 = 1 (start of RDS update); $V_o = 0.5 \text{ V}$	1.0	1.2	1.4	mA
<i>Output: pin AFSAMPLE</i>						
$I_{\text{sink(max)}}$	maximum sink current	no RDS update in progress; $V_o = 0.5 \text{ V}$	1.0	1.2	1.4	mA

Notes

- Measured between pins XTAL1 and XTAL2.
- DAA conversion gain formula: $V_{\text{DAAOUT}} = \left[2 \times \left(0.75 \times \frac{n}{128} + 0.125 \right) \times (V_{\text{DAAIN}} + V_{\text{DAATD}}) \right] - V_{\text{DAATD}}$; where $n = 0$ to 127.
- Input parameters of FM mixer 2 measured between pins FMMIX2IN and FMMIX2DEC.
- Input parameters of AM IF2 measured between pins AMIF2IN and AMIF2DEC.
- Reference frequency pin FREF: $R_{\text{ext}} = 68 \text{ k}\Omega$ connected to ground activates the 2nd I²C-bus address.
- Input parameters of AM mixer 1 measured between pins AMMIX1DEC and AMMIX1IN.
- Output parameters of FM mixer and AM mixer 1 measured between pins MIX1OUT1 and MIX1OUT2.
- Input parameters of AM mixer 2 measured between pins IFAMPIN and IFAMPDEC.
- Output parameters of AM mixer 2 measured between pins AMMIX2OUT1 and AMMIX2OUT2.
- Input parameters of FM mixer measured between pins FMMIXIN1 and FMMIXIN2.

New In Car Entertainment car radio tuner IC with Precision Adjacent Channel Suppression (NICE-PACS)

TEA6849H

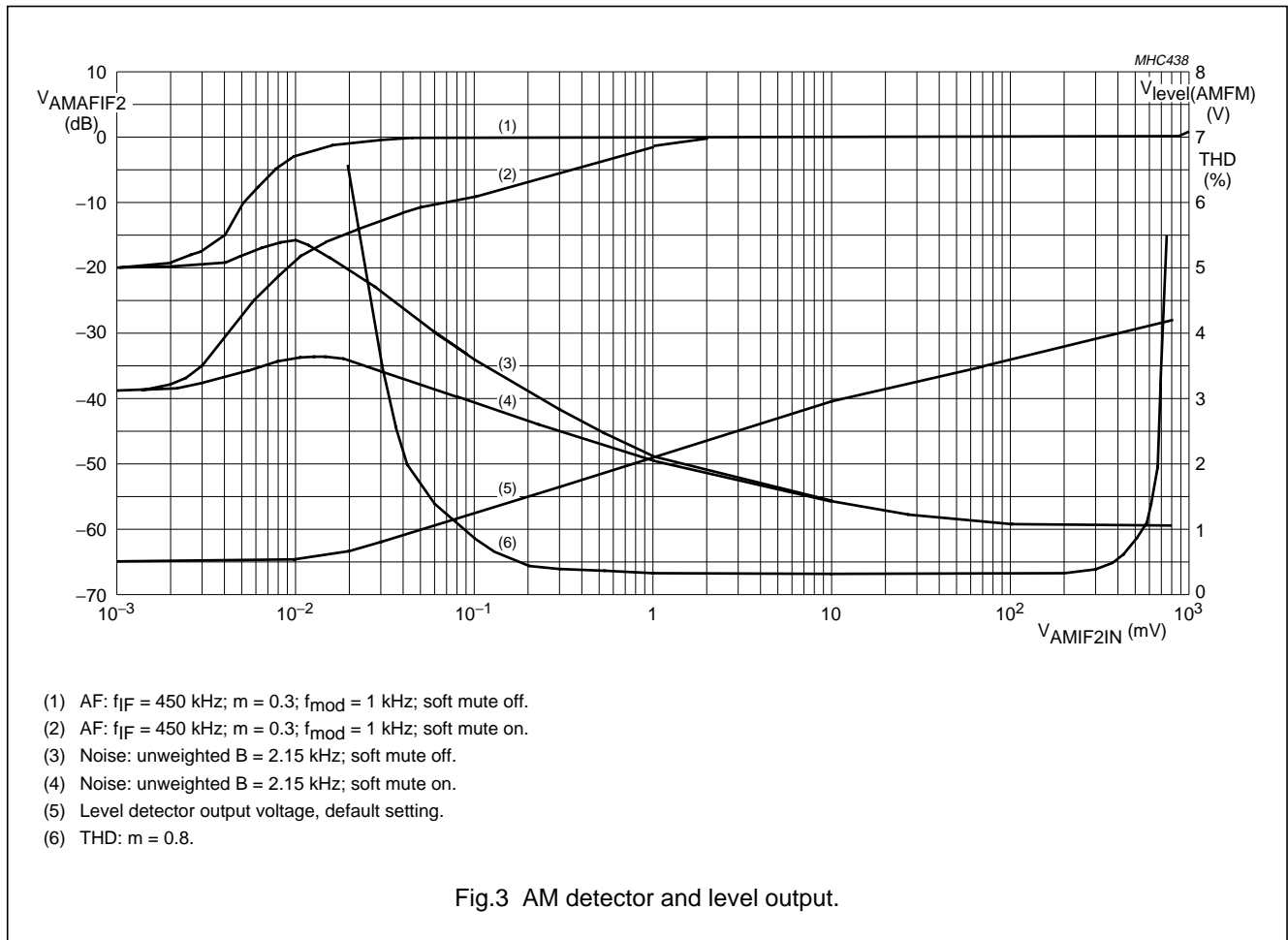

New In Car Entertainment car radio tuner IC with Precision Adjacent Channel Suppression (NICE-PACS)

TEA6849H

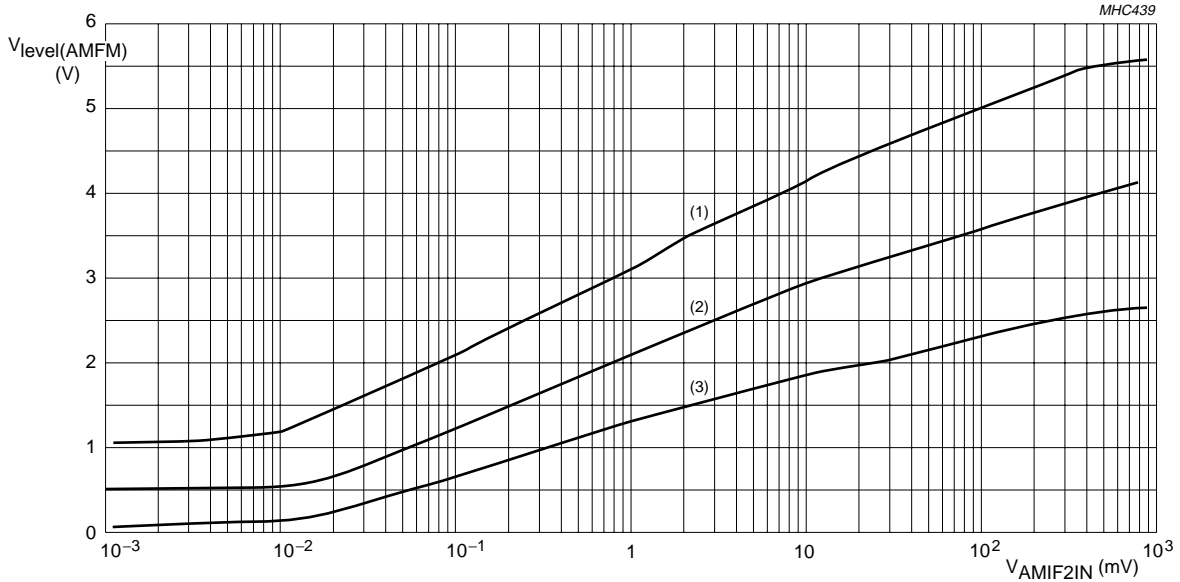

- (1) Level DAA setting byte 5 = FFH.
- (2) Level DAA setting byte 5 = 84H (standard setting).
- (3) Level DAA setting byte 5 = 00H.

Fig.4 AM level voltage.

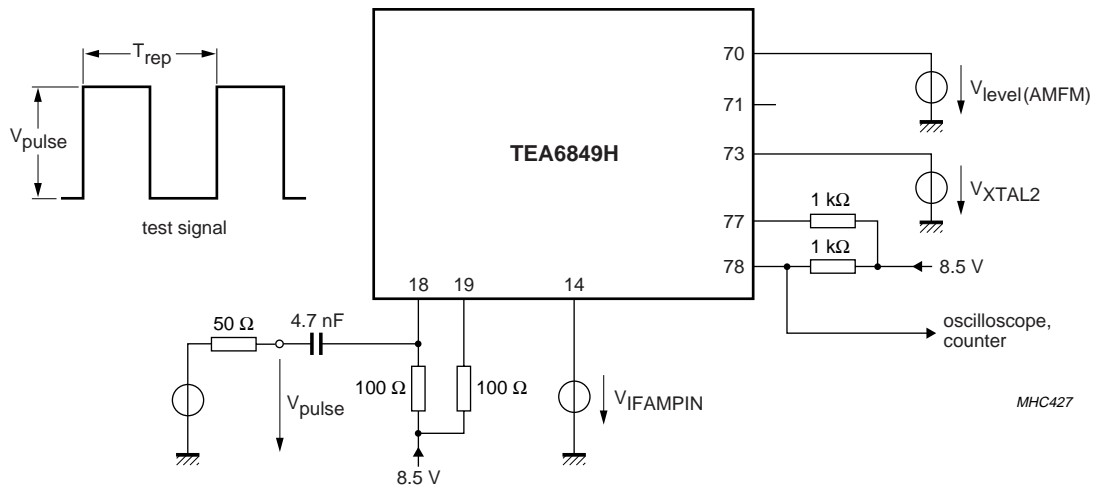

Test signal: $T_{rep} = 2 \text{ ms}$, $t_r < 50 \text{ ns}$, $t_f < 50 \text{ ns}$ and duty factor 50%.
 $V_{IFAMPIN} = 4 \text{ V}$ and $V_{XTAL2} = 3 \text{ V}$.

Fig.5 Test circuit for AM noise blanker.

New In Car Entertainment car radio tuner IC with Precision Adjacent Channel Suppression (NICE-PACS)

TEA6849H

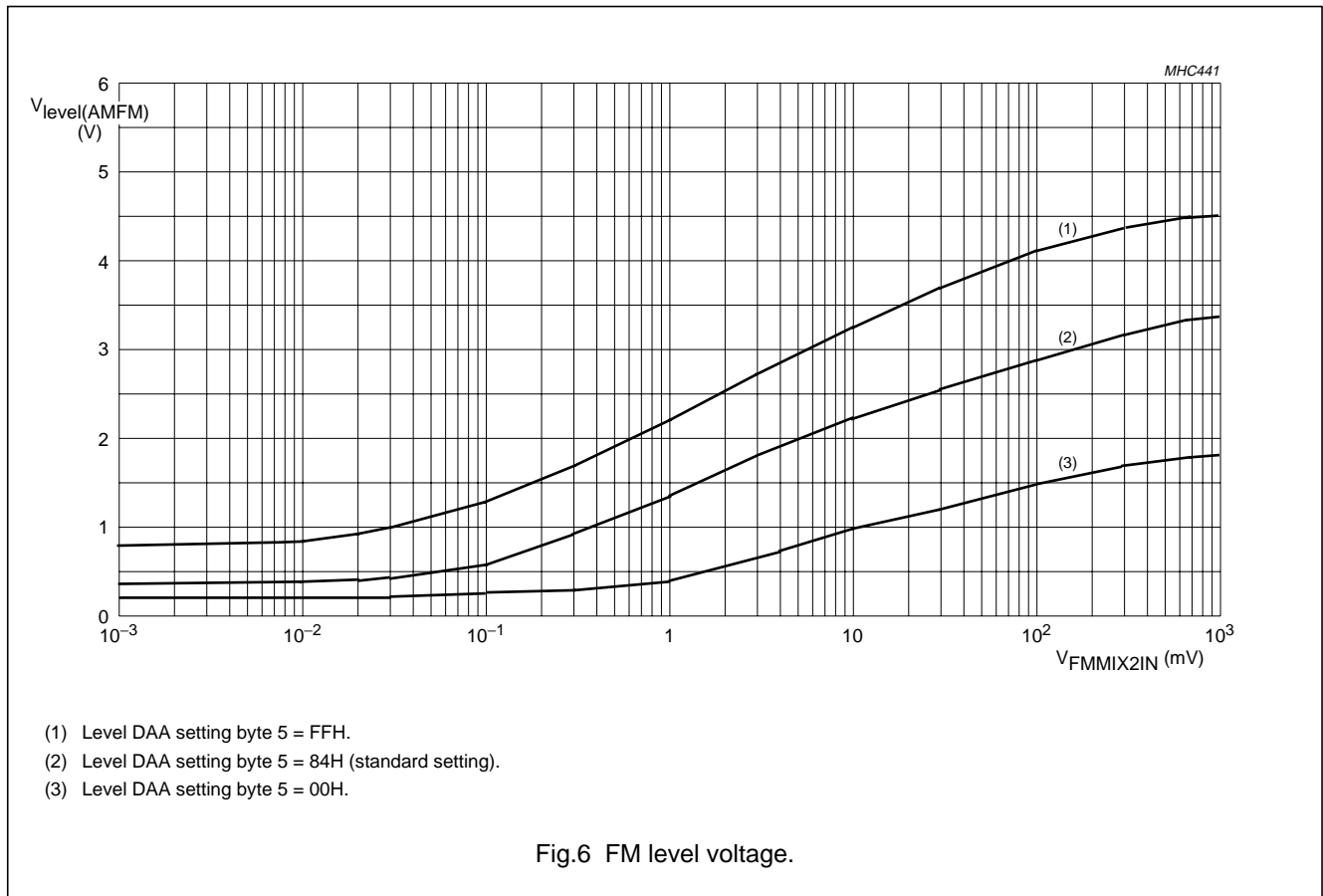

New In Car Entertainment car radio tuner IC with Precision Adjacent Channel Suppression (NICE-PACS)

TEA6849H

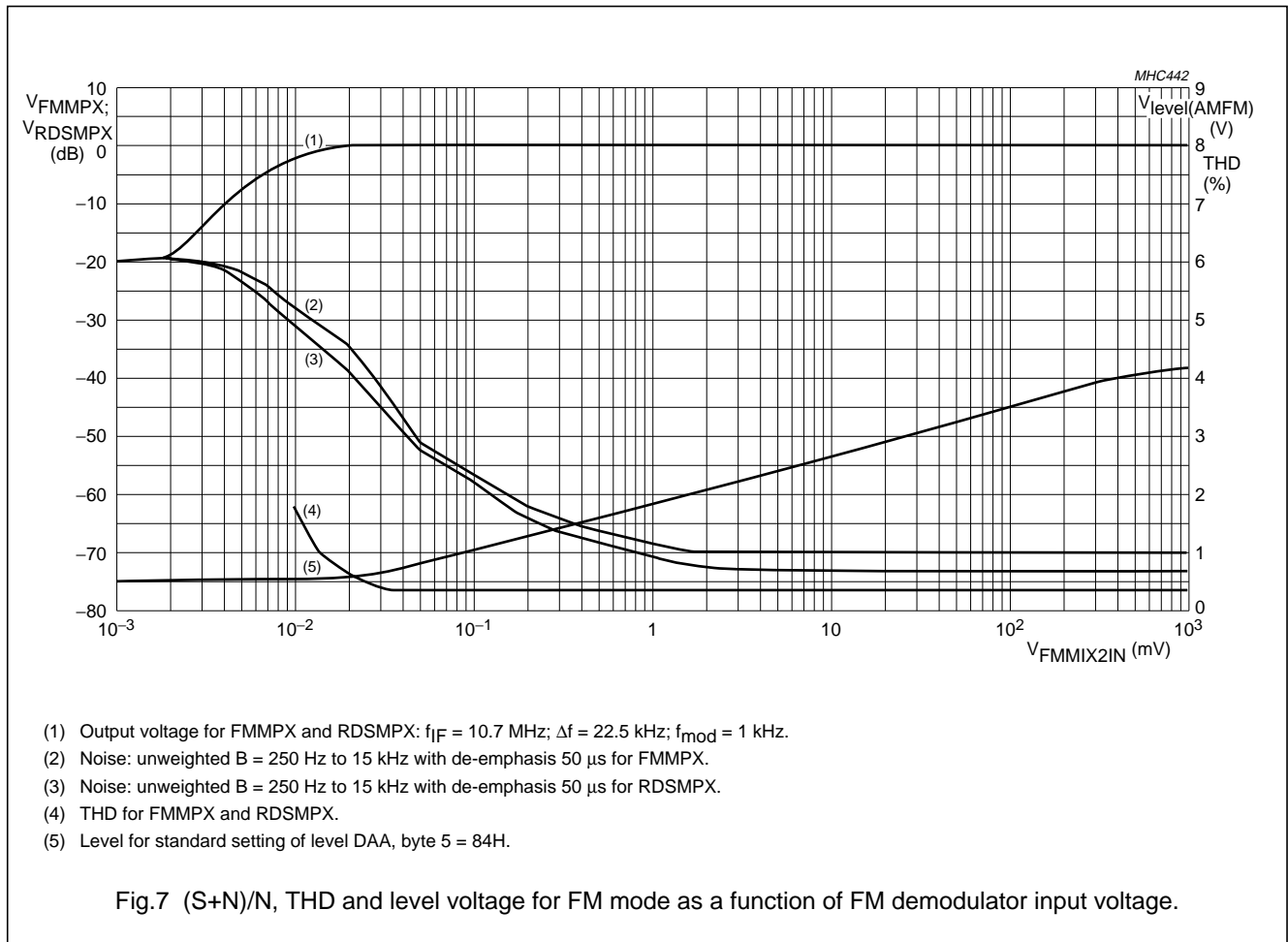

New In Car Entertainment car radio tuner IC with Precision Adjacent Channel Suppression (NICE-PACS)

TEA6849H

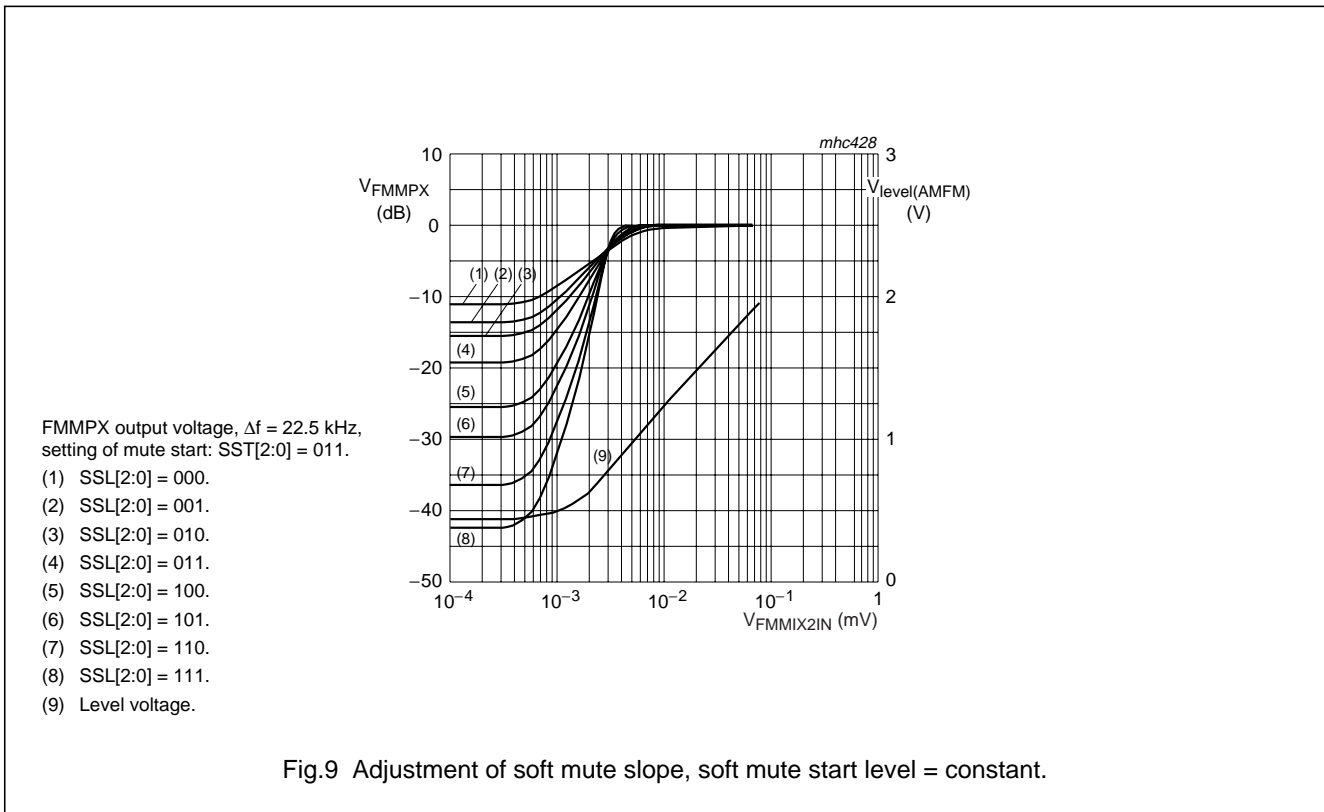
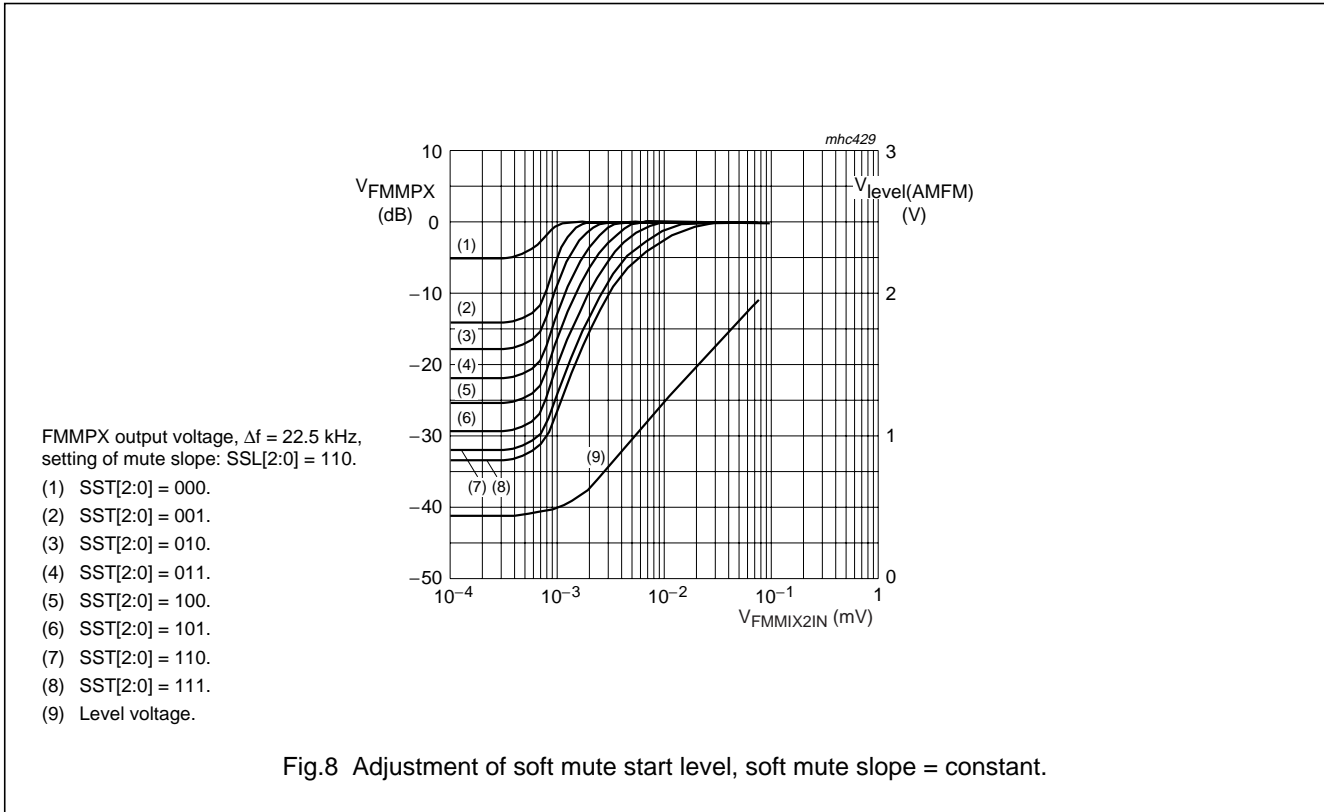

New In Car Entertainment car radio tuner IC with Precision Adjacent Channel Suppression (NICE-PACS)

TEA6849H

12 I²C-BUS PROTOCOL

12.1 I²C-bus specification

Information about the I²C-bus can be found in the brochure "The I²C-bus and how to use it" (order number 9398 393 40011).

The standard I²C-bus specification is expanded by the following definitions.

IC addresses:

- 1st IC address C2H: 1100001 R/ \overline{W}
- 2nd IC address C0H: 1100000 R/ \overline{W} .

Structure of the I²C-bus logic: slave transceiver with auto increment.

Subaddresses are not used.

A second I²C-bus address can be selected by connecting pin FREF via a 68 k Ω resistor to GND.

Exception to the standard I²C-bus specification:

- The data hold time $t_{HD,DAT}$ must be at least 1 μ s.

12.1.1 DATA TRANSFER

Data sequence: address, byte 0, byte 1, byte 2, byte 3, byte 4, byte 5, byte 6, and byte 7. The data transfer has to be in this order. The LSB = 0 indicates a WRITE operation to the TEA6849H.

Bit 7 of each byte is considered the MSB and has to be transferred as the first bit of the byte.

The data becomes valid at the output of the internal latches with the acknowledge of each byte. A STOP condition after any byte can shorten transmission times.

When writing to the transceiver by using the STOP condition before completion of the whole transfer:

- The remaining bytes will contain the old information
- If the transfer of a byte is not completed, this byte is lost and the previous information is available.

12.1.2 I²C-BUS PULL-UP RESISTORS

When the IC is used together with the TEA688x or TEF689x and both SCL and SDA lines are connected via the I²C-bus to the TEA688x or TEF689x, the pull-up resistors of the tuner IC should be connected to the digital supply voltage of the TEA688x or TEF689x. Otherwise an I²C-bus pull-down can occur switching off the tuner IC supply when the I²C-bus buffer interface of the TEA688x or TEF689x is enabled for data transfer to the tuner IC.

12.1.3 FREQUENCY SETTING

For new frequency setting, in both AM and FM mode, the programmable divider is enabled by setting bit MUTE = 1. To select an FM frequency, two I²C-bus transmissions are necessary:

- First: bit MUTE = 1
- Second: bit MUTE = 0.

12.1.4 DEFAULT SETTINGS

No default settings at power-on reset. One I²C-bus transmission is required to program the IC.

New In Car Entertainment car radio tuner IC with Precision Adjacent Channel Suppression (NICE-PACS)

TEA6849H

12.2 I²C-bus protocol

12.2.1 DATA TRANSFER MODE AND IC ADDRESS

Table 1 Write mode

S ⁽¹⁾	address (write)	A ⁽²⁾	data byte(s)	A ⁽²⁾	P ⁽³⁾
------------------	-----------------	------------------	--------------	------------------	------------------

Notes

1. S = START condition.
2. A = acknowledge.
3. P = STOP condition.

Table 2 Read mode

S ⁽¹⁾	address (read)	A ⁽²⁾	data byte 1
------------------	----------------	------------------	-------------

Notes

1. S = START condition.
2. A = acknowledge.

Table 3 IC address byte

IC ADDRESS						MODE
1	1	0	0	0	0	0/1 ⁽¹⁾
						R/W ⁽²⁾

Notes

1. Defined by address pin FREF:
 - a) 1 = 1st IC address
 - b) 0 = 2nd IC address.
2. Read or write mode:
 - a) 0 = write operation to TEA6849H
 - b) 1 = read operation from TEA6849H.

12.2.2 WRITE MODE: DATA BYTE 0

Table 4 Format of data byte 0

BIT 7	BIT 6	BIT 5	BIT 4	BIT 3	BIT 2	BIT 1	BIT 0
AF	PLL14	PLL13	PLL12	PLL11	PLL10	PLL9	PLL8

Table 5 Description of data byte 0 bits

BIT	SYMBOL	DESCRIPTION
7	AF	Alternative frequency. If AF = 0, then normal operation. If AF = 1, then AF (RDS) update mode.
6 to 0	PLL[14:8]	Setting of programmable counter of synthesizer PLL. Upper byte of PLL divider word.

New In Car Entertainment car radio tuner IC with Precision Adjacent Channel Suppression (NICE-PACS)

TEA6849H

12.2.3 WRITE MODE: DATA BYTE 1

Table 6 Format of data byte 1

BIT 7	BIT 6	BIT 5	BIT 4	BIT 3	BIT 2	BIT 1	BIT 0
PLL7	PLL6	PLL5	PLL4	PLL3	PLL2	PLL1	PLL0

Table 7 Description of data byte 1 bits

BIT	SYMBOL	DESCRIPTION
7 to 0	PLL[7:0]	Setting of programmable counter of synthesizer PLL. Lower byte of PLL divider word.

12.2.4 WRITE MODE: DATA BYTE 2

Table 8 Format of data byte 2

BIT 7	BIT 6	BIT 5	BIT 4	BIT 3	BIT 2	BIT 1	BIT 0
MUTE	DAA6	DAA5	DAA4	DAA3	DAA2	DAA1	DAA0

Table 9 Description of data byte 2 bits

BIT	SYMBOL	DESCRIPTION
7	MUTE	FM audio mute. If MUTE = 0, then FM audio not muted. If MUTE = 1, then FM audio muted; writing to programmable divider and antenna DAA enabled.
6 to 0	DAA[6:0]	Setting of antenna digital auto alignment.

12.2.5 WRITE MODE: DATA BYTE 3

Table 10 Format of data byte 3

BIT 7	BIT 6	BIT 5	BIT 4	BIT 3	BIT 2	BIT 1	BIT 0
IFMT	FREF2	FREF1	FREF0	IFPR	BND1	BND0	AMFM

Table 11 Description of data byte 3 bits

BIT	SYMBOL	DESCRIPTION
7	IFMT	IF measuring time. If IFMT = 0, then IF measuring time is 20 ms. If IFMT = 1, then IF measuring time is 2 ms.
6 to 4	FREF[2:0]	Reference frequency for synthesizer. These 3 bits determine the reference frequency, see Table 12.
3	IFPR	IF counter prescaler ratio. If IFPR = 0, then IF prescaler ratio is 40. If IFPR = 1, then IF prescaler ratio is 10.
2 and 1	BND[1:0]	Band switch. These 2 bits select in FM mode band and local or distant, see Table 13; in AM mode band and AM stereo, see Table 14.
0	AMFM	AM or FM switch. If AMFM = 0, then FM mode. If AMFM = 1, then AM mode.

New In Car Entertainment car radio tuner IC with Precision Adjacent Channel Suppression (NICE-PACS)

TEA6849H

Table 12 Reference frequency setting

FREF2	FREF1	FREF0	f _{ref} (kHz)
0	0	0	100
1	0	0	50
0	1	0	25
1	1	0	20
0	0	1	10
1	0	1	10
0	1	1	10
1	1	1	10

Table 13 FM mode

BND1	BND0	FREQUENCY BAND	VCO DIVIDER	CHARGE PUMP CURRENT
0	0	FM standard	2	130 μ A + 3 mA
0	1	FM Japan	3	130 μ A + 3 mA
1	0	FM East Europe	3	1 mA
1	1	FM weather	1	300 μ A

Table 14 AM mode

BND1	BND0	FREQUENCY BAND	VCO DIVIDER	CHARGE PUMP CURRENT
0	0	AM SW mono	10	1 mA
0	1	AM SW stereo	10	1 mA
1	0	AM LW/MW mono	20	1 mA
1	1	AM LW/MW stereo	20	1 mA

12.2.6 WRITE MODE: DATA BYTE 4

Table 15 Format of data byte 4

BIT 7	BIT 6	BIT 5	BIT 4	BIT 3	BIT 2	BIT 1	BIT 0
KAGC	AGC1	AGC0	AMSM	LODX	FLAG	BW1	BW0

New In Car Entertainment car radio tuner IC with Precision Adjacent Channel Suppression (NICE-PACS)

TEA6849H

Table 16 Description of data byte 4 bits

BIT	SYMBOL	DESCRIPTION
7	KAGC	Keyed FM AGC. If KAGC = 0, then keyed FM AGC is off. If KAGC = 1, then keyed FM AGC is on.
6 and 5	AGC[1:0]	Wideband AGC. These 2 bits set the start value of wideband AGC. For AM, see Table 17 and for FM, see Table 18.
4	AMSM	AM soft mute. If AMSM = 0, then AM soft mute is off. If AMSM = 1, then AM soft mute is on (default).
3	LODX	Local or distance. If LODX = 0, then distance mode is on. If LODX = 1, then local mode is on.
2	FLAG	Software programmable flag. If FLAG = 0, then flag output pin SWFLAG is HIGH. If FLAG = 1, then flag output pin SWFLAG is LOW.
1 and 0	BW[1:0]	FM IF2 bandwidth setting. See Table 19.

Table 17 Setting of wideband AGC for AM (m = 0.3)

AGC1	AGC0	AM MIXER 1 INPUT VOLTAGE (PEAK VALUE) (mV)
0	0	150
0	1	275
1	0	400
1	1	525

Table 18 Setting of wideband AGC for FM

AGC1	AGC0	FM RF MIXER INPUT VOLTAGE (RMS VALUE) (mV)
1	1	3
1	0	6
0	1	9
0	0	12

Table 19 FM IF2 bandwidth setting

BW1	BW0	FM IF2 BANDWIDTH B ₋₃ dB
0	0	dynamic mode
0	1	130 kHz fixed
1	0	90 kHz fixed
1	1	60 kHz fixed

New In Car Entertainment car radio tuner IC with Precision Adjacent Channel Suppression (NICE-PACS)

TEA6849H

12.2.7 WRITE MODE: DATA BYTE 5

Table 20 Format of data byte 5

BIT 7	BIT 6	BIT 5	BIT 4	BIT 3	BIT 2	BIT 1	BIT 0
LST4	LST3	LST2	LST1	LST0	LSL2	LSL1	LSL0

Table 21 Description of data byte 5 bits

BIT	SYMBOL	DESCRIPTION
7 to 3	LST[4:0]	Setting of level DAA starting point. These 5 bits determine the offset of the level detector output voltage.
2 to 0	LSL[2:0]	Setting of level DAA slope. These 3 bits determine the steepness of the level detector output voltage.

Table 22 Standard setting of data byte 5 bits

SETTING OF LEVEL DAA STARTING POINT					SETTING OF LEVEL DAA SLOPE		
LST4	LST3	LST2	LST1	LST0	LSL2	LSL1	LSL0
1	0	0	0	0	1	0	0

12.2.8 WRITE MODE: DATA BYTE 6

Table 23 Format of data byte 6

BIT 7	BIT 6	BIT 5	BIT 4	BIT 3	BIT 2	BIT 1	BIT 0
TE	CF6	CF5	CF4	CF3	CF2	CF1	CF0

Table 24 Description of data byte 6 bits

BIT	SYMBOL	DESCRIPTION
7	TE	Threshold extension. If TE = 0, then threshold extension is off. If TE = 1, then threshold extension is on.
6 to 0	CF[6:0]	Setting of FM IF2 centre frequency DAA. The content of CF6 to CF0 determines the centre frequency of the 450 kHz filter.

12.2.9 WRITE MODE: DATA BYTE 7

Table 25 Format of data byte 7

BIT 7	BIT 6	BIT 5	BIT 4	BIT 3	BIT 2	BIT 1	BIT 0
0	FMSM	SSL2	SSL1	SSL0	SST2	SST1	SST0

Table 26 Description of data byte 7 bits

BIT	SYMBOL	DESCRIPTION
7	–	This bit is not used and must be set to logic 0.
6	FMSM	FM soft mute. If FMSM = 0, then FM soft mute is off. If FMSM = 1, then FM soft mute is on.
5 to 3	SSL[2:0]	Setting of FM soft mute slope; 000 is flattest setting; see Fig.8
2 to 0	SST[2:0]	Setting of soft mute start; 000 is lowest setting; see Fig.9

New In Car Entertainment car radio tuner IC with Precision Adjacent Channel Suppression (NICE-PACS)

TEA6849H

12.2.10 READ MODE: DATA BYTE 0

Table 27 Format of 1st data byte

BIT 7	BIT 6	BIT 5	BIT 4	BIT 3	BIT 2	BIT 1	BIT 0
IFC7	IFC6	IFC5	IFC4	IFC3	IFC2	IFC1	IFC0

Table 28 Description of data byte 0 bits

BIT	SYMBOL	DESCRIPTION
7 to 0	IFC[7:0]	IF counter result. These bits contain the least significant eight bits of the IF counter result.

13 TEST AND APPLICATION INFORMATION

Table 29 List of components for test and application circuits (Figs 10, 11, 12 and 13)

SYMBOL	PARAMETER	TYPE	MANUFACTURER
C1	capacitor for VCO tuning	270 pF; type NP0	–
L1	10.7 MHz IF coil	P7 PSG P826RC 5134N=S	TOKO
L2	450 kHz IF coil	P7PSGAE-5078D=S	TOKO
L3	oscillator coil	E543SNAS-02010	TOKO
L4	FM image rejection	611SNS-1066Y	TOKO
L5	FM input transformer	369INS-3076X	TOKO
L6	FM antenna coil	LQN1HR50; 215 nH	MURATA
L7	PIN diode bias	LQN1HR21; 500 nH	MURATA
L8	connection image reject	wire 10 mm/printed coil	–
L9	AM input	388BN-1211Z	TOKO
R4	resistor for stabilizer	3.3 k Ω ; RC12G	BC Components
–	crystal 20.5 MHz	LN-G102-587	NDK

New In Car Entertainment car radio tuner IC with Precision Adjacent Channel Suppression (NICE-PACS)

TEA6849H

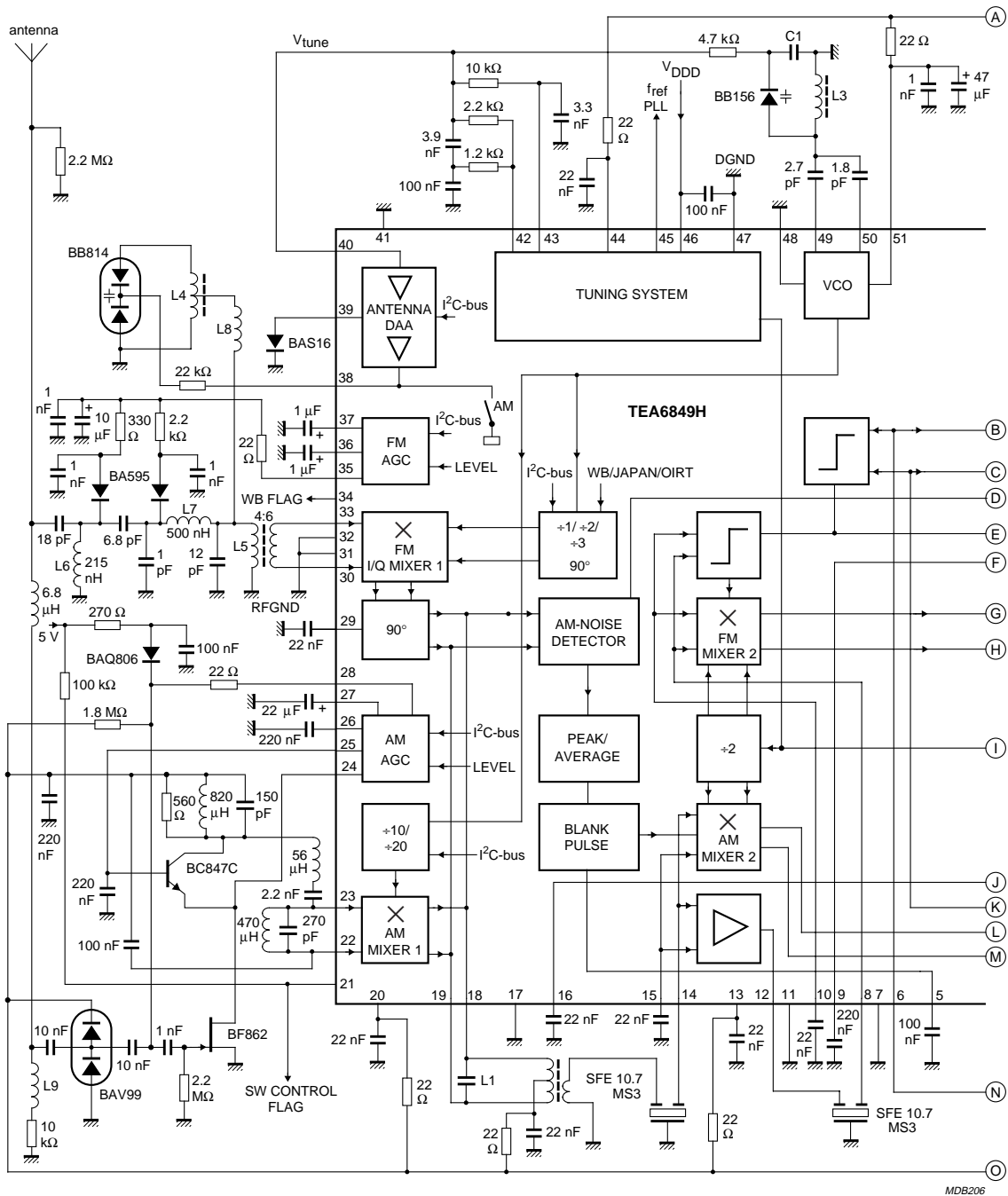

MDB206

For list of components see Table 29.

Fig.10 Application diagram (continued in Fig.11).

New In Car Entertainment car radio tuner IC with Precision Adjacent Channel Suppression (NICE-PACS)

TEA6849H

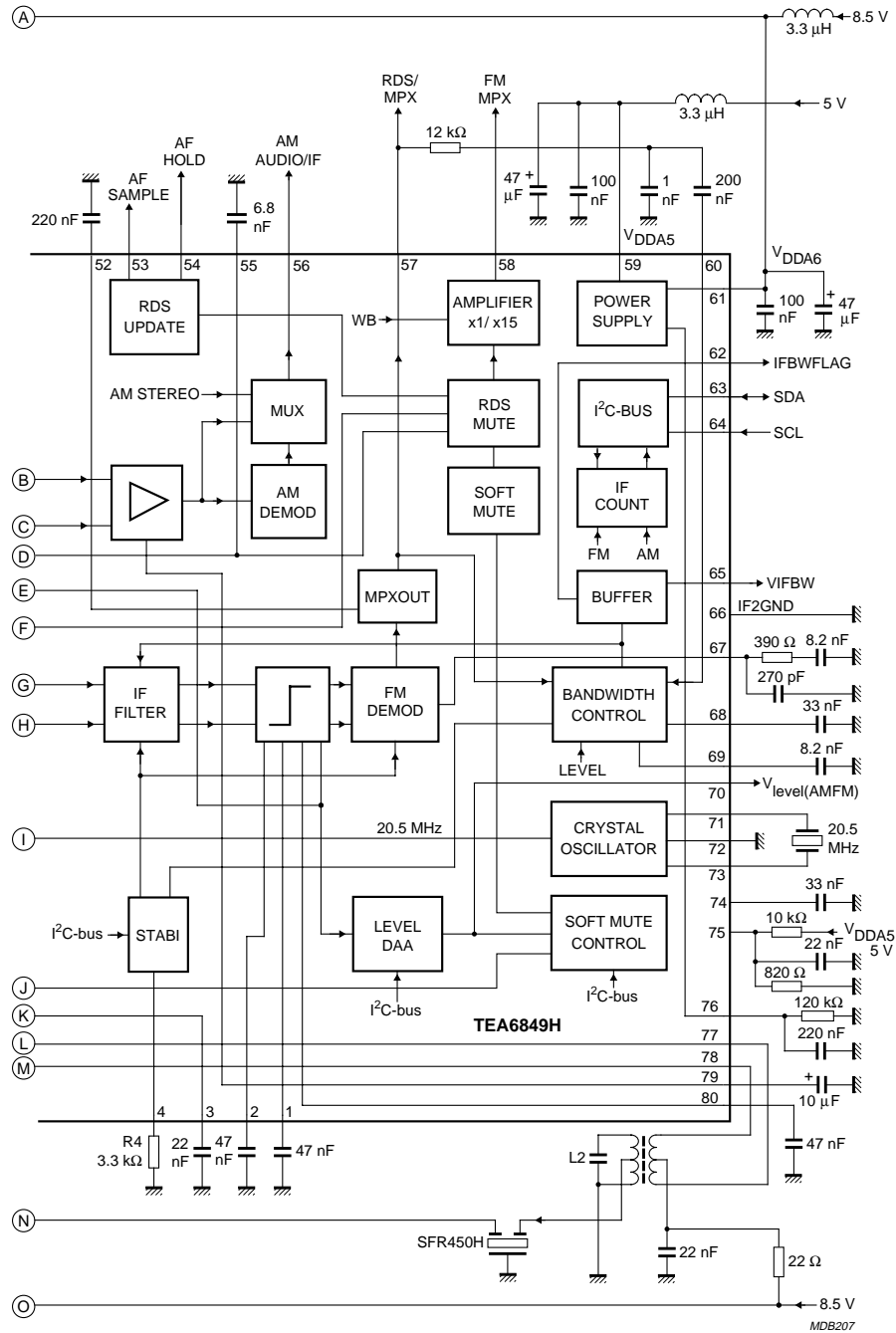
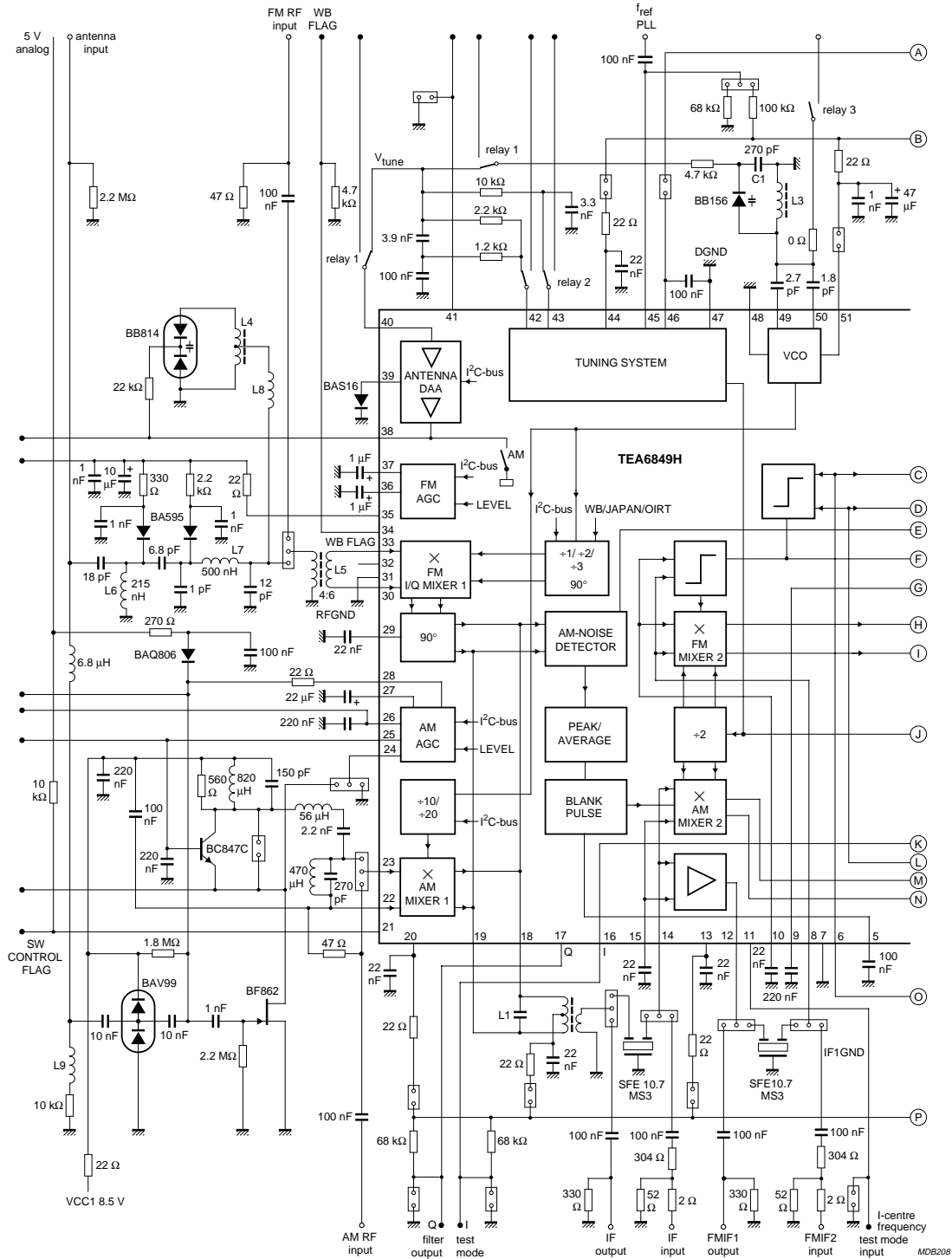

Fig.11 Application diagram (continued from Fig.10).

New In Car Entertainment car radio tuner IC with Precision Adjacent Channel Suppression (NICE-PACS)

TEA6849H



For list of components see Table 29.

Fig.12 Test circuit (continued in Fig.13).

New In Car Entertainment car radio tuner IC with Precision Adjacent Channel Suppression (NICE-PACS)

TEA6849H

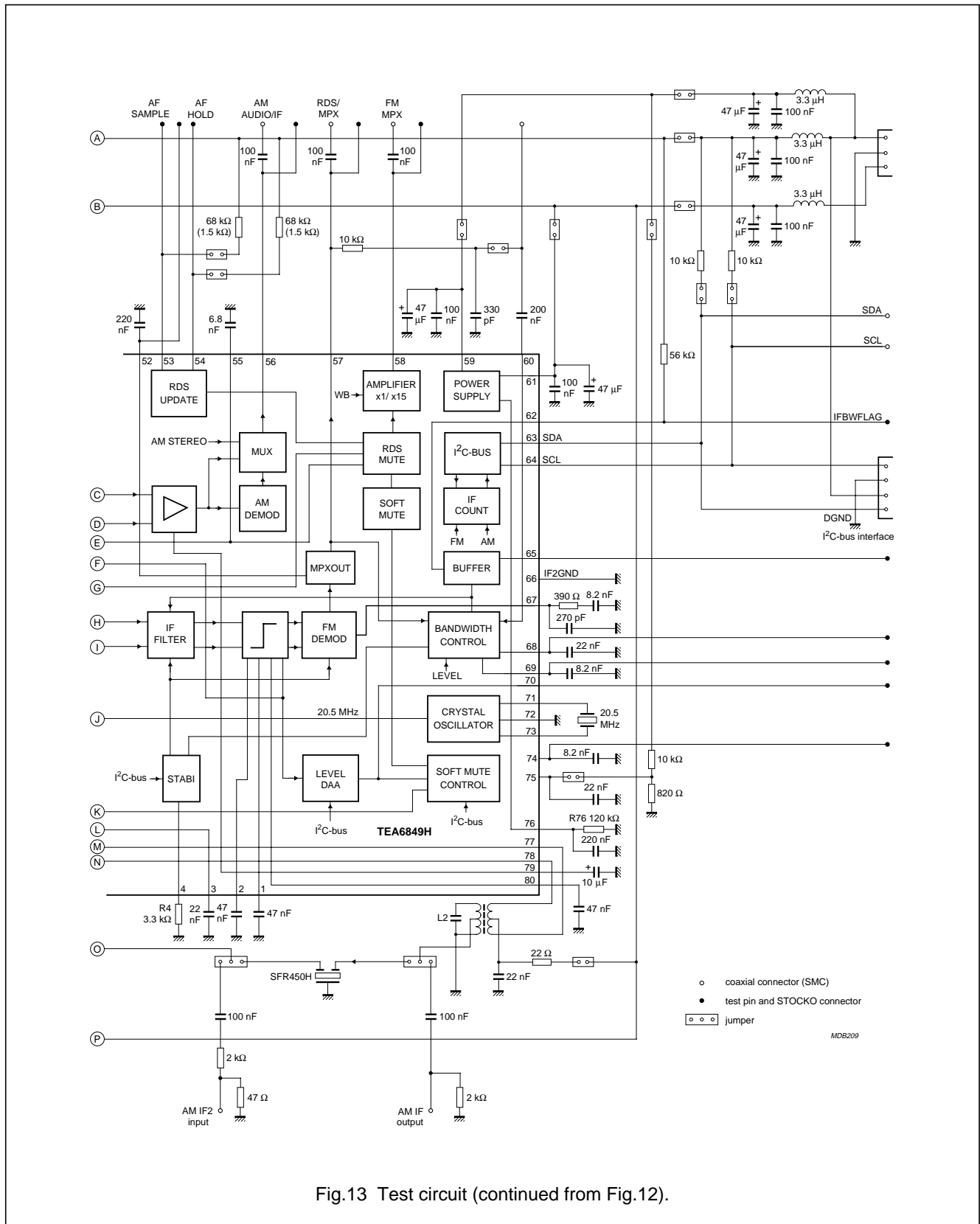

Fig.13 Test circuit (continued from Fig.12).

New In Car Entertainment car radio tuner IC with Precision Adjacent Channel Suppression (NICE-PACS)

TEA6849H

Table 30 DC operating points

SYMBOL	PIN	UNLOADED DC VOLTAGE (V)					
		AM MODE			FM MODE		
		MIN.	TYP.	MAX.	MIN.	TYP.	MAX.
FMLIMDCFDB1	1	floating			3.7	4.2	4.8
FMLIMDCFDB2	2	floating			3.7	4.2	4.8
AMIF2DEC	3	2.4	2.7	3.2	floating		
IREFFMIF2	4	0			0.4	0.55	0.7
AMNBHOLD	5	4.3	4.6	5.1	8	8.4	–
AMIF2IN	6	2.4	2.7	3.2	floating		
IF1GND	7	external 0			external 0		
FMMIX2IN	8	0	0.1	–	1.5	1.8	2.1
COFFSET	9	floating			3.5	4	4.5
FMMIX2DEC	10	0	0.1	–	1.5	1.8	2.1
IFCDAATEST	11	0			0		
IFAMPOUT	12	7.2	7.9	–	2.4	3	3.6
V _{DDA1}	13	external 8.5			external 8.5		
IFAMPIN	14	2.4	2.7	3	1.5	2	2.5
IFAMPDEC	15	2.4	2.7	3	1.5	2	2.5
IF2FILQ	16	0			0		
IF2FILI	17	0			0		
MIX1OUT1	18	external 8.5			external 8.5		
MIX1OUT2	19	external 8.5			external 8.5		
V _{DDA2}	20	external 8.5			external 8.5		
SWFLAG	21	open-collector					
AMMIX1DEC	22	2.3	2.75	3.1	floating		
AMMIX1IN	23	2.3	2.75	3.1	floating		
VAMCASFB	24	3.7	4.3	4.9	0	0.1	0.2
VAMCAS	25	4.5	5	5.5	0	0.1	1
TAFAMAGC	26	0	2.8	4.6	0 (no WB)	0.3 (no WB)	0.5 (no WB)
THFAMAGC	27	2.5	2.8	3.1	floating		
IAMAGC	28	8.5 (external biasing)			1	2	3
V _{ref(MIX)}	29	2.7	3.1	3.4	6.5	7.1	7.9
FMMIXIN1	30	1	1.3	1.6	2.3	2.8	3.3
RFGND	31	external 0			external 0		
i.c.	32	–			–		
FMMIXIN2	33	1	1.3	1.6	2.3	2.8	3.3
WBFLAG	34	0			4 (WB)	4.5 (WB)	5 (WB)
					– (FM)	<0.5 (FM)	– (FM)
IFMAGC	35	5 (external application)			0.1 (external biasing)	–	4 (external biasing)

New In Car Entertainment car radio tuner IC with Precision Adjacent Channel Suppression (NICE-PACS)

TEA6849H

SYMBOL	PIN	UNLOADED DC VOLTAGE (V)					
		AM MODE			FM MODE		
		MIN.	TYP.	MAX.	MIN.	TYP.	MAX.
TFMAGC	36	7.5	8	8.3	3.9	4.6	5.3
TKEYEDAGC	37	floating			1	–	7
DAAOUT	38	–	0.2	0.3	0.2	–	8.25
DAATD	39	floating			0.2	–	1.5
DAAIN	40	0	–	8.5	0	–	8.5
FMMUTE	41	–			–		
V _{tune}	42	0	–	8.5	0	–	8.5
CPOUT	43	0	–	8.5	0	–	8.5
V _{DDA3}	44	external 8.5			external 8.5		
FREF	45	3.2	3.4	3.7	3.2	3.4	3.7
V _{DDD}	46	external 5			external 5		
DGND	47	external 0			external 0		
VCOGND	48	external 0			external 0		
OSCFDB	49	2.2	2.8	3.4	2.2	2.8	3.4
OSCTNK	50	5	6.1	7.2	5	6.1	7.2
V _{DDA4}	51	external 8.5			external 8.5		
MPXDCFDB	52	–			2	2.4	2.8
AFSAMPLE	53	0	0.2	0.5	0	0.2	0.5
AFHOLD	54	open-collector 5			open-collector		
TRDSMUTE	55	1.7	2.2	2.7	0.7 (muted)	1.2 (muted)	1.7 (muted)
					5.2 (not muted)	5.7 (not muted)	6.2 (not muted)
AMAFIF2	56	4	4.3	4.6	floating 3.3		
RDSMPX	57	0			3.2	4	4.8
FMMPX	58	0	0.5	1	3.2	4	4.8
V _{DDA5}	59	external 5			external 5		
MODEDET	60	0			2	2.5	3
V _{DDA6}	61	external 8.5			external 8.5		
IFBWFLAG	62	open-collector 8.5			open-collector 8.5		
SDA	63	4.8	5	5.2	4.8	5	5.2
SCL	64	4.8	5	5.2	4.8	5	5.2
V _{IFBW}	65	0	0.1	–	0.5	–	4
IF2GND	66	external 0			external 0		
CINT	67	0			3.2	4	4.8
MODETOUT	68	0			2	3	4
TACD	69	0			3.5	4.2	4.9
V _{level(AMFM)}	70	0	–	7	0	–	7
XTAL1	71	1.7	2.1	2.5	1.7	2.1	2.5
XTALGND	72	external 0			external 0		

New In Car Entertainment car radio tuner IC with Precision Adjacent Channel Suppression (NICE-PACS)

TEA6849H

SYMBOL	PIN	UNLOADED DC VOLTAGE (V)					
		AM MODE			FM MODE		
		MIN.	TYP.	MAX.	MIN.	TYP.	MAX.
XTAL2	73	1.7	2.1	2.5	1.7	2.1	2.5
V _{level(ACD)}	74	0.5	1	2	0.3	0.5	0.8
ACDTHRES	75	external 0.2	–	external 0.5	external 0.2	–	external 0.5
IREF	76	4	4.25	4.5	4	4.25	4.5
AMMIX2OUT1	77	external 8.5			external 8.5		
AMMIX2OUT2	78	external 8.5			external 8.5		
CAGC	79	3.6	4.3	4.8	4.1	4.6	5.1
V _{ref(lim)}	80	0.5	0.8	1.2	3.6	4.2	4.8

14 INTERNAL CIRCUITRY

Table 31 Equivalent pin circuits

PIN	SYMBOL	EQUIVALENT CIRCUIT
1 2	FMLIMDCFDB1 FMLIMDCFDB2	<p>MDB088</p>
3 6	AMIF2DEC AMIF2IN	<p>MHC375</p>

New In Car Entertainment car radio tuner IC with Precision Adjacent Channel Suppression (NICE-PACS)

TEA6849H

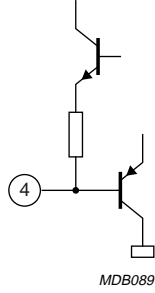
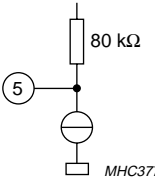
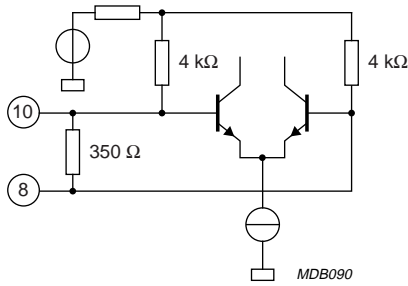
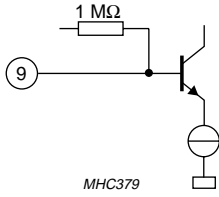
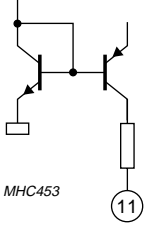
PIN	SYMBOL	EQUIVALENT CIRCUIT
4	IREFFMIF2	
5	AMNBHOLD	
7	IF1GND	
8	FMMIX2IN	
10	FMMIX2DEC	
9	COFFSET	
11	IFCDAATEST	

New In Car Entertainment car radio tuner IC with Precision Adjacent Channel Suppression (NICE-PACS)

TEA6849H

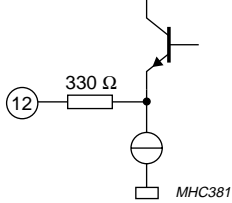
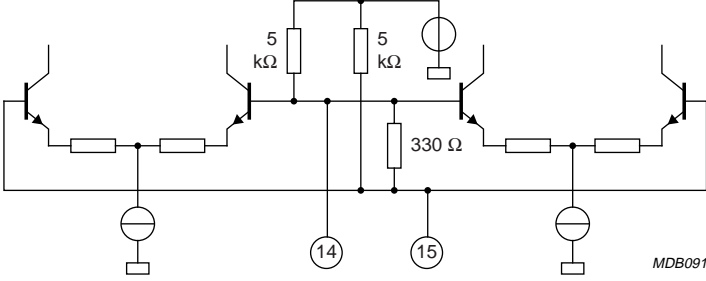
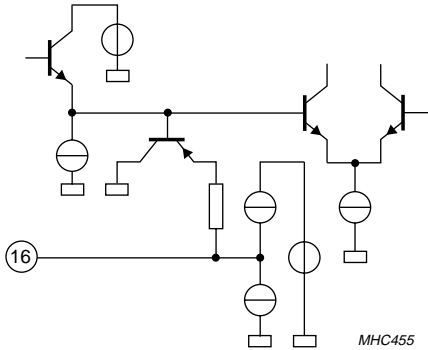
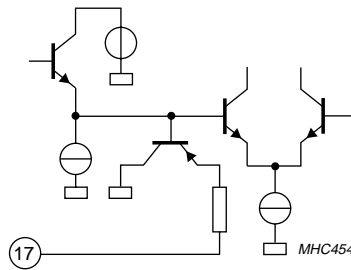
PIN	SYMBOL	EQUIVALENT CIRCUIT
12	IFAMPOUT	
13	V_{DDA1}	
14	IFAMPIN	
15	IFAMPDEC	
16	IF2FILQ	
17	IF2FILI	

New In Car Entertainment car radio tuner IC with Precision Adjacent Channel Suppression (NICE-PACS)

TEA6849H

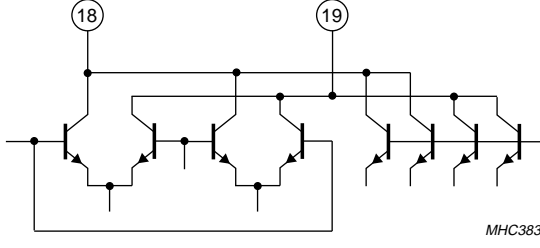
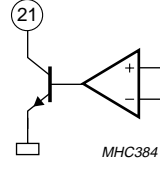
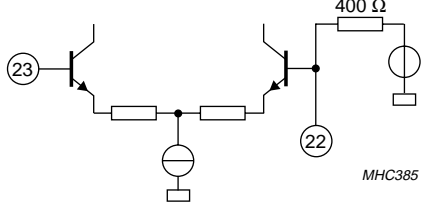
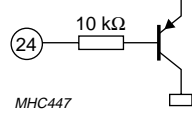
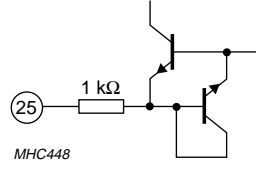
PIN	SYMBOL	EQUIVALENT CIRCUIT
18	MIX1OUT1	
19	MIX1OUT2	
20	V _{DDA2}	
21	SWFLAG	
22	AMMIX1DEC	
23	AMMIX1IN	
24	VAMCASFB	
25	VAMCAS	

New In Car Entertainment car radio tuner IC with Precision Adjacent Channel Suppression (NICE-PACS)

TEA6849H

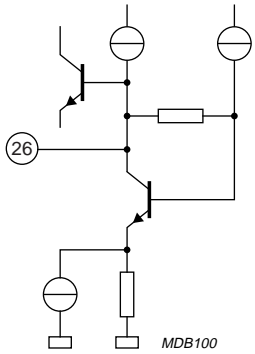
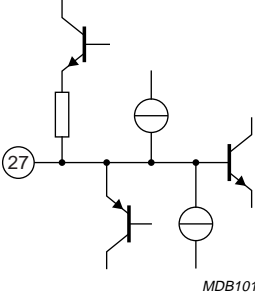
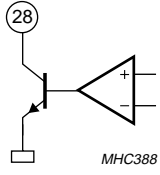
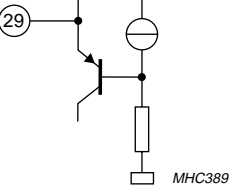
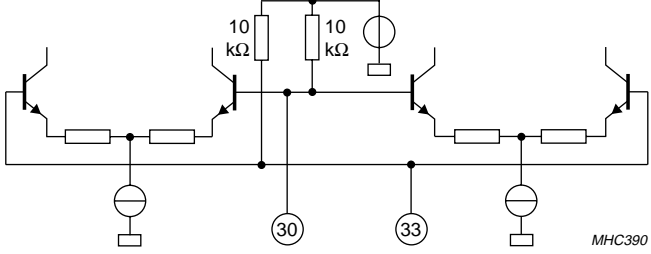
PIN	SYMBOL	EQUIVALENT CIRCUIT
26	TAFAMAGC	
27	THFAMAGC	
28	IAMAGC	
29	$V_{ref(MIX)}$	
30	FMMIXIN1	
33	FMMIXIN2	

New In Car Entertainment car radio tuner IC with Precision Adjacent Channel Suppression (NICE-PACS)

TEA6849H

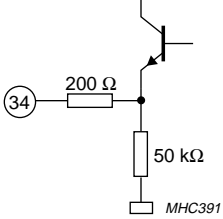
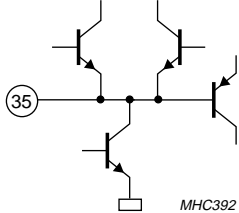
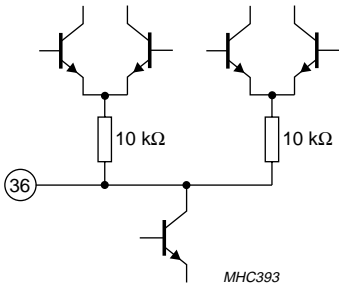
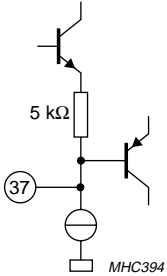
PIN	SYMBOL	EQUIVALENT CIRCUIT
31	RFGND	
32	i.c.	
34	WBFLAG	
35	IFMAGC	
36	TFMAGC	
37	TKEYEDAGC	

New In Car Entertainment car radio tuner IC with Precision Adjacent Channel Suppression (NICE-PACS)

TEA6849H

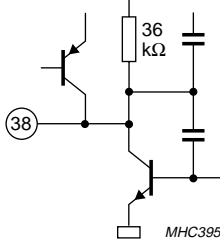
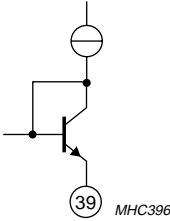
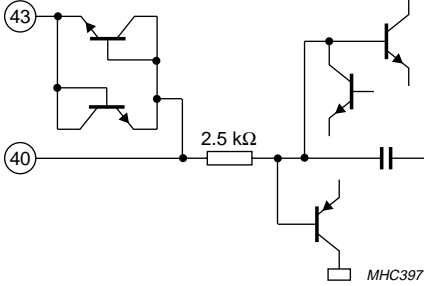
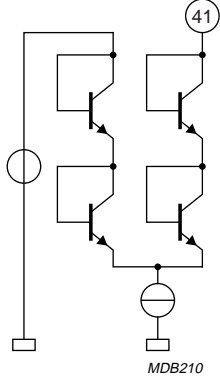
PIN	SYMBOL	EQUIVALENT CIRCUIT
38	DAAOUT	
39	DAATD	
40	DAAIN	
41	FMMUTE	

New In Car Entertainment car radio tuner IC with Precision Adjacent Channel Suppression (NICE-PACS)

TEA6849H

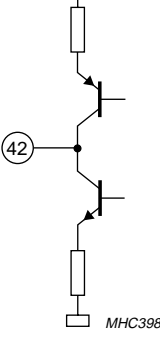
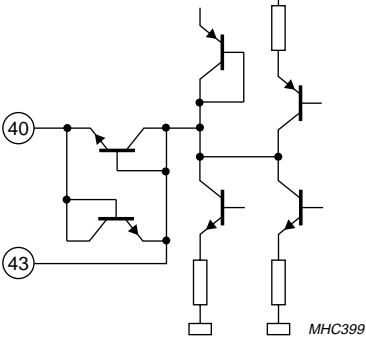
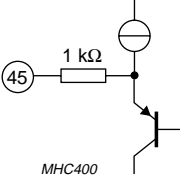
PIN	SYMBOL	EQUIVALENT CIRCUIT
42	V_{tune}	
43	CPOUT	
44	V_{DDA3}	
45	FREF	
46	V_{DD}	
47	DGND	
48	VCOGND	

New In Car Entertainment car radio tuner IC with Precision Adjacent Channel Suppression (NICE-PACS)

TEA6849H

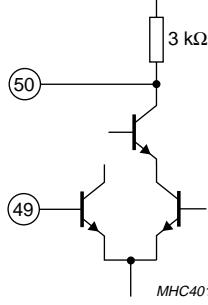
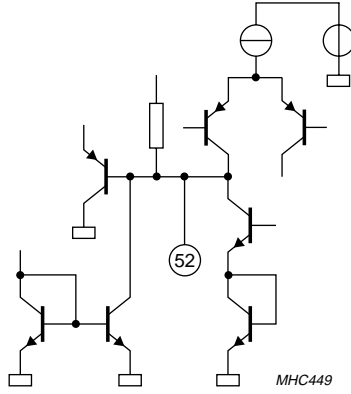
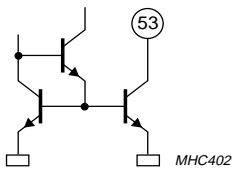
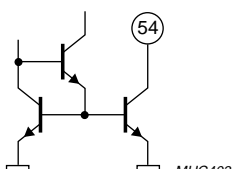
PIN	SYMBOL	EQUIVALENT CIRCUIT
49	OSCFDB	
50	OSCTNK	
51	V_{DDA4}	
52	MPXDCFDB	
53	AFSAMPLE	
54	AFHOLD	

New In Car Entertainment car radio tuner IC with Precision Adjacent Channel Suppression (NICE-PACS)

TEA6849H

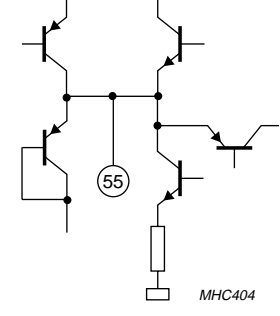
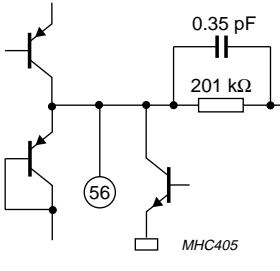
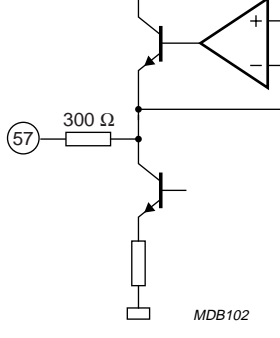
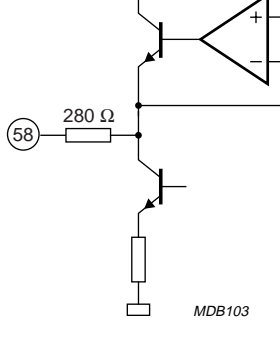
PIN	SYMBOL	EQUIVALENT CIRCUIT
55	TRDSMUTE	
56	AMAFIF2	
57	RDSMPX	
58	FMMPX	
59	V _{DDA5}	

New In Car Entertainment car radio tuner IC with Precision Adjacent Channel Suppression (NICE-PACS)

TEA6849H

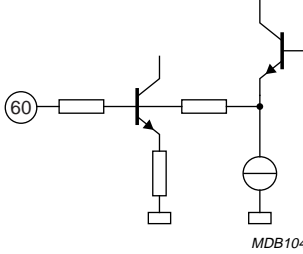
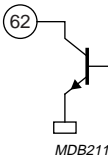
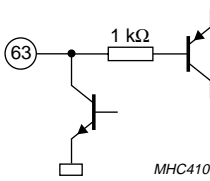
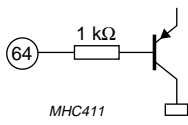
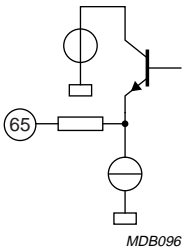
PIN	SYMBOL	EQUIVALENT CIRCUIT
60	MODDET	 <p>MDB104</p>
61	V_{DDA6}	
62	IFBWFLAG	 <p>MDB211</p>
63	SDA	 <p>MHC410</p>
64	SCL	 <p>MHC411</p>
65	V_{IFBW}	 <p>MDB096</p>
66	IF2GND	

New In Car Entertainment car radio tuner IC with Precision Adjacent Channel Suppression (NICE-PACS)

TEA6849H

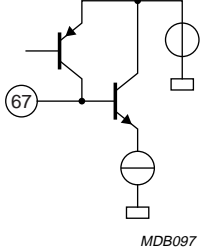
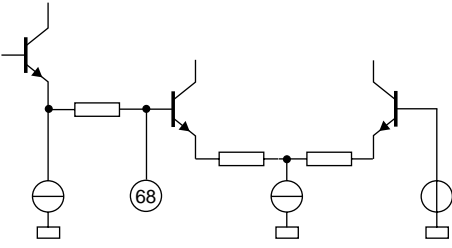
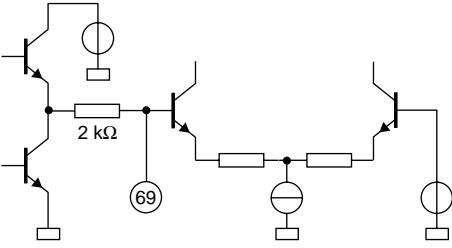
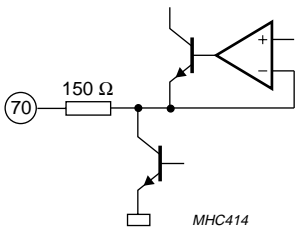
PIN	SYMBOL	EQUIVALENT CIRCUIT
67	CINT	 <p>MDB097</p>
68	MODETOUT	 <p>MHC450</p>
69	TACD	 <p>2 kΩ</p> <p>MHC451</p>
70	$V_{level(AMFM)}$	 <p>150 Ω</p> <p>MHC414</p>

New In Car Entertainment car radio tuner IC with Precision Adjacent Channel Suppression (NICE-PACS)

TEA6849H

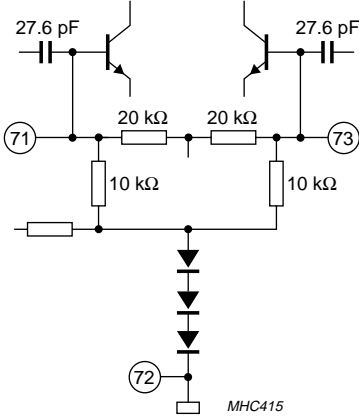
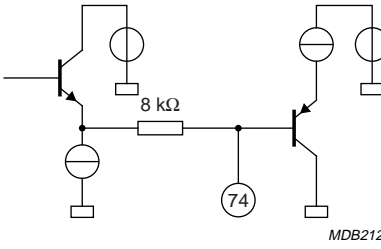
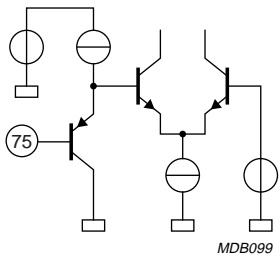
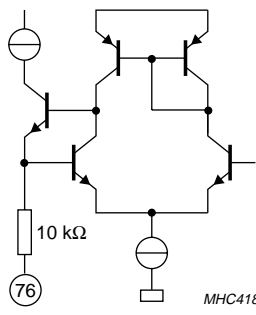
PIN	SYMBOL	EQUIVALENT CIRCUIT
71	XTAL1	
72	XTALGND	
73	XTAL2	
74	$V_{level(ACD)}$	
75	ACDTHRES	
76	IREF	

New In Car Entertainment car radio tuner IC with Precision Adjacent Channel Suppression (NICE-PACS)

TEA6849H

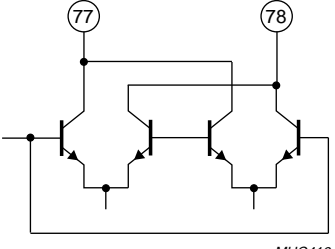
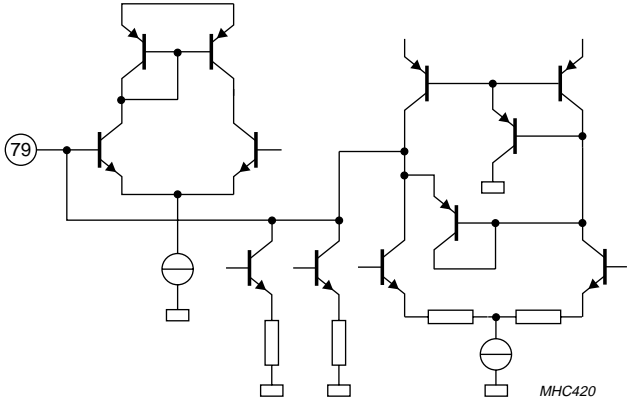
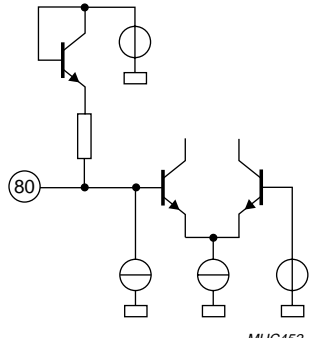
PIN	SYMBOL	EQUIVALENT CIRCUIT
77	AMMIX2OUT1	 <p style="text-align: right; margin-right: 50px;"><i>MHC419</i></p>
78	AMMIX2OUT2	
79	CAGC	 <p style="text-align: right; margin-right: 50px;"><i>MHC420</i></p>
80	$V_{ref(lim)}$	 <p style="text-align: right; margin-right: 50px;"><i>MHC452</i></p>

New In Car Entertainment car radio tuner IC with Precision Adjacent Channel Suppression (NICE-PACS)

TEA6849H

15 PACKAGE OUTLINE

LQFP80: plastic low profile quad flat package; 80 leads; body 12 x 12 x 1.4 mm

SOT315-1

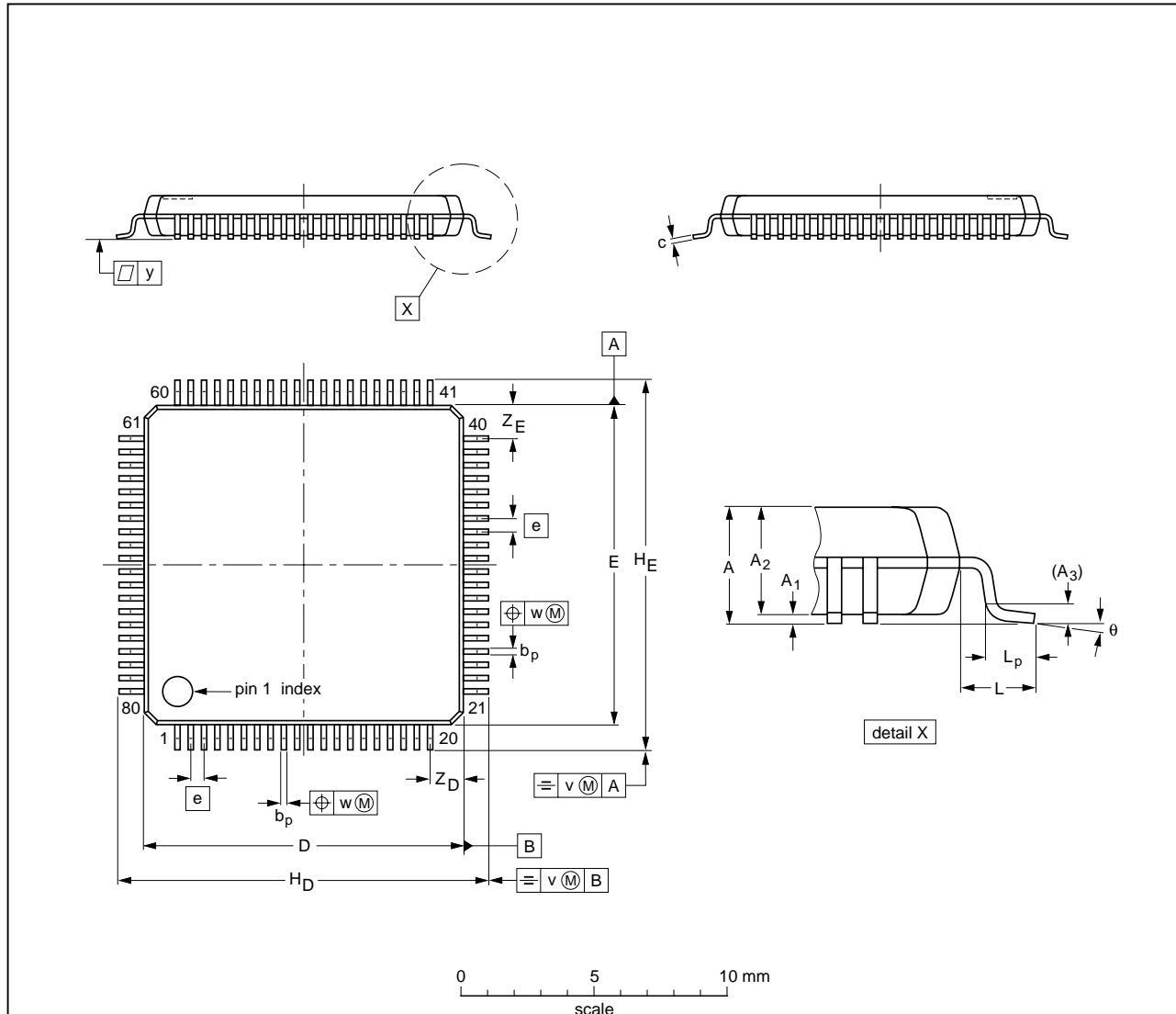

DIMENSIONS (mm are the original dimensions)

UNIT	A max.	A ₁	A ₂	A ₃	b _p	c	D ⁽¹⁾	E ⁽¹⁾	e	H _D	H _E	L	L _p	v	w	y	Z _D ⁽¹⁾	Z _E ⁽¹⁾	θ
mm	1.6	0.16 0.04	1.5 1.3	0.25	0.27 0.13	0.18 0.12	12.1 11.9	12.1 11.9	0.5	14.15 13.85	14.15 13.85	1	0.75 0.30	0.2	0.15	0.1	1.45 1.05	1.45 1.05	7° 0°

Note

1. Plastic or metal protrusions of 0.25 mm maximum per side are not included.

OUTLINE VERSION	REFERENCES			EUROPEAN PROJECTION	ISSUE DATE
	IEC	JEDEC	JEITA		
SOT315-1	136E15	MS-026			00-01-19 03-02-25

New In Car Entertainment car radio tuner IC with Precision Adjacent Channel Suppression (NICE-PACS)

TEA6849H

16 SOLDERING

16.1 Introduction to soldering surface mount packages

This text gives a very brief insight to a complex technology. A more in-depth account of soldering ICs can be found in our *"Data Handbook IC26; Integrated Circuit Packages"* (document order number 9398 652 90011).

There is no soldering method that is ideal for all surface mount IC packages. Wave soldering can still be used for certain surface mount ICs, but it is not suitable for fine pitch SMDs. In these situations reflow soldering is recommended.

16.2 Reflow soldering

Reflow soldering requires solder paste (a suspension of fine solder particles, flux and binding agent) to be applied to the printed-circuit board by screen printing, stencilling or pressure-syringe dispensing before package placement. Driven by legislation and environmental forces the worldwide use of lead-free solder pastes is increasing.

Several methods exist for reflowing; for example, convection or convection/infrared heating in a conveyor type oven. Throughput times (preheating, soldering and cooling) vary between 100 and 200 seconds depending on heating method.

Typical reflow peak temperatures range from 215 to 270 °C depending on solder paste material. The top-surface temperature of the packages should preferably be kept:

- below 220 °C (SnPb process) or below 245 °C (Pb-free process)
 - for all BGA and SSOP-T packages
 - for packages with a thickness ≥ 2.5 mm
 - for packages with a thickness < 2.5 mm and a volume ≥ 350 mm³ so called thick/large packages.
- below 235 °C (SnPb process) or below 260 °C (Pb-free process) for packages with a thickness < 2.5 mm and a volume < 350 mm³ so called small/thin packages.

Moisture sensitivity precautions, as indicated on packing, must be respected at all times.

16.3 Wave soldering

Conventional single wave soldering is not recommended for surface mount devices (SMDs) or printed-circuit boards with a high component density, as solder bridging and non-wetting can present major problems.

To overcome these problems the double-wave soldering method was specifically developed.

If wave soldering is used the following conditions must be observed for optimal results:

- Use a double-wave soldering method comprising a turbulent wave with high upward pressure followed by a smooth laminar wave.
- For packages with leads on two sides and a pitch (e):
 - larger than or equal to 1.27 mm, the footprint longitudinal axis is **preferred** to be parallel to the transport direction of the printed-circuit board;
 - smaller than 1.27 mm, the footprint longitudinal axis **must** be parallel to the transport direction of the printed-circuit board.

The footprint must incorporate solder thieves at the downstream end.

- For packages with leads on four sides, the footprint must be placed at a 45° angle to the transport direction of the printed-circuit board. The footprint must incorporate solder thieves downstream and at the side corners.

During placement and before soldering, the package must be fixed with a droplet of adhesive. The adhesive can be applied by screen printing, pin transfer or syringe dispensing. The package can be soldered after the adhesive is cured.

Typical dwell time of the leads in the wave ranges from 3 to 4 seconds at 250 °C or 265 °C, depending on solder material applied, SnPb or Pb-free respectively.

A mildly-activated flux will eliminate the need for removal of corrosive residues in most applications.

16.4 Manual soldering

Fix the component by first soldering two diagonally-opposite end leads. Use a low voltage (24 V or less) soldering iron applied to the flat part of the lead. Contact time must be limited to 10 seconds at up to 300 °C.

When using a dedicated tool, all other leads can be soldered in one operation within 2 to 5 seconds between 270 and 320 °C.

New In Car Entertainment car radio tuner IC with Precision Adjacent Channel Suppression (NICE-PACS)

TEA6849H

16.5 Suitability of surface mount IC packages for wave and reflow soldering methods

PACKAGE ⁽¹⁾	SOLDERING METHOD	
	WAVE	REFLOW ⁽²⁾
BGA, LBGA, LFBGA, SQFP, SSOP-T ⁽³⁾ , TFBGA, VFBGA	not suitable	suitable
DHVQFN, HBCC, HBGA, HLQFP, HSQFP, HSOP, HTQFP, HTSSOP, HVQFN, HVSON, SMS	not suitable ⁽⁴⁾	suitable
PLCC ⁽⁵⁾ , SO, SOJ	suitable	suitable
LQFP, QFP, TQFP	not recommended ⁽⁵⁾⁽⁶⁾	suitable
SSOP, TSSOP, VSO, VSSOP	not recommended ⁽⁷⁾	suitable
PMFP ⁽⁸⁾	not suitable	not suitable

Notes

- For more detailed information on the BGA packages refer to the “(LF)BGA Application Note” (AN01026); order a copy from your Philips Semiconductors sales office.
- All surface mount (SMD) packages are moisture sensitive. Depending upon the moisture content, the maximum temperature (with respect to time) and body size of the package, there is a risk that internal or external package cracks may occur due to vaporization of the moisture in them (the so called popcorn effect). For details, refer to the Drypack information in the “Data Handbook IC26; Integrated Circuit Packages; Section: Packing Methods”.
- These transparent plastic packages are extremely sensitive to reflow soldering conditions and must on no account be processed through more than one soldering cycle or subjected to infrared reflow soldering with peak temperature exceeding $217\text{ °C} \pm 10\text{ °C}$ measured in the atmosphere of the reflow oven. The package body peak temperature must be kept as low as possible.
- These packages are not suitable for wave soldering. On versions with the heatsink on the bottom side, the solder cannot penetrate between the printed-circuit board and the heatsink. On versions with the heatsink on the top side, the solder might be deposited on the heatsink surface.
- If wave soldering is considered, then the package must be placed at a 45° angle to the solder wave direction. The package footprint must incorporate solder thieves downstream and at the side corners.
- Wave soldering is suitable for LQFP, TQFP and QFP packages with a pitch (e) larger than 0.8 mm; it is definitely not suitable for packages with a pitch (e) equal to or smaller than 0.65 mm.
- Wave soldering is suitable for SSOP, TSSOP, VSO and VSSOP packages with a pitch (e) equal to or larger than 0.65 mm; it is definitely not suitable for packages with a pitch (e) equal to or smaller than 0.5 mm.
- Hot bar or manual soldering is suitable for PMFP packages.

New In Car Entertainment car radio tuner IC with Precision Adjacent Channel Suppression (NICE-PACS)

TEA6849H

17 DATA SHEET STATUS

LEVEL	DATA SHEET STATUS ⁽¹⁾	PRODUCT STATUS ⁽²⁾⁽³⁾	DEFINITION
I	Objective data	Development	This data sheet contains data from the objective specification for product development. Philips Semiconductors reserves the right to change the specification in any manner without notice.
II	Preliminary data	Qualification	This data sheet contains data from the preliminary specification. Supplementary data will be published at a later date. Philips Semiconductors reserves the right to change the specification without notice, in order to improve the design and supply the best possible product.
III	Product data	Production	This data sheet contains data from the product specification. Philips Semiconductors reserves the right to make changes at any time in order to improve the design, manufacturing and supply. Relevant changes will be communicated via a Customer Product/Process Change Notification (CPCN).

Notes

1. Please consult the most recently issued data sheet before initiating or completing a design.
2. The product status of the device(s) described in this data sheet may have changed since this data sheet was published. The latest information is available on the Internet at URL <http://www.semiconductors.philips.com>.
3. For data sheets describing multiple type numbers, the highest-level product status determines the data sheet status.

18 DEFINITIONS

Short-form specification — The data in a short-form specification is extracted from a full data sheet with the same type number and title. For detailed information see the relevant data sheet or data handbook.

Limiting values definition — Limiting values given are in accordance with the Absolute Maximum Rating System (IEC 60134). Stress above one or more of the limiting values may cause permanent damage to the device. These are stress ratings only and operation of the device at these or at any other conditions above those given in the Characteristics sections of the specification is not implied. Exposure to limiting values for extended periods may affect device reliability.

Application information — Applications that are described herein for any of these products are for illustrative purposes only. Philips Semiconductors make no representation or warranty that such applications will be suitable for the specified use without further testing or modification.

19 DISCLAIMERS

Life support applications — These products are not designed for use in life support appliances, devices, or systems where malfunction of these products can reasonably be expected to result in personal injury. Philips Semiconductors customers using or selling these products for use in such applications do so at their own risk and agree to fully indemnify Philips Semiconductors for any damages resulting from such application.

Right to make changes — Philips Semiconductors reserves the right to make changes in the products - including circuits, standard cells, and/or software - described or contained herein in order to improve design and/or performance. When the product is in full production (status 'Production'), relevant changes will be communicated via a Customer Product/Process Change Notification (CPCN). Philips Semiconductors assumes no responsibility or liability for the use of any of these products, conveys no licence or title under any patent, copyright, or mask work right to these products, and makes no representations or warranties that these products are free from patent, copyright, or mask work right infringement, unless otherwise specified.

New In Car Entertainment car radio tuner IC with
Precision Adjacent Channel Suppression (NICE-PACS)

TEA6849H

20 PURCHASE OF PHILIPS I²C COMPONENTS

Purchase of Philips I²C components conveys a license under the Philips' I²C patent to use the components in the I²C system provided the system conforms to the I²C specification defined by Philips. This specification can be ordered using the code 9398 393 40011.

Philips Semiconductors – a worldwide company

Contact information

For additional information please visit <http://www.semiconductors.philips.com>. Fax: +31 40 27 24825

For sales offices addresses send e-mail to: sales.addresses@www.semiconductors.philips.com.

© Koninklijke Philips Electronics N.V. 2003

SCA75

All rights are reserved. Reproduction in whole or in part is prohibited without the prior written consent of the copyright owner.

The information presented in this document does not form part of any quotation or contract, is believed to be accurate and reliable and may be changed without notice. No liability will be accepted by the publisher for any consequence of its use. Publication thereof does not convey nor imply any license under patent- or other industrial or intellectual property rights.

Printed in The Netherlands

R32/01/pp65

Date of release: 2003 Dec 19

Document order number: 9397 750 10607

Let's make things better.

**Philips
Semiconductors**



PHILIPS