

HD74HC175

Quad. D-type Flip-Flops (with Clear)

REJ03D0585-0300

Rev.3.00

Jan 31, 2006

Description

Information at the D inputs of the HD74HC175 is transferred to the Q and \bar{Q} outputs on the positive going edge of the clock pulse. Both true and compliment outputs from each flip-flop are externally available. All four flip-flops are controlled by a common clock and a common clear. Clearing is accomplished by a negative pulse at the clear input. All four Q outputs are cleared to a logic low level and all four \bar{Q} outputs to a logic high level.



Features

- High Speed Operation: t_{pd} (Clock to Q) = 14 ns typ ($C_L = 50$ pF)
- High Output Current: Fanout of 10 LSTTL Loads
- Wide Operating Voltage: $V_{CC} = 2$ to 6 V
- Low Input Current: 1 μ A max
- Low Quiescent Supply Current: I_{CC} (static) = 4 μ A max ($T_a = 25^\circ\text{C}$)
- Ordering Information

Part Name	Package Type	Package Code (Previous Code)	Package Abbreviation	Taping Abbreviation (Quantity)
HD74HC175P	DILP-16 pin	PRDP0016AE-B (DP-16FV)	P	—
HD74HC175TELL	TSSOP-16 pin	PTSP0016JB-A (TTP-16DAV)	T	ELL (2,000 pcs/reel)

Note: Please consult the sales office for the above package availability.

Function Table

Inputs			Output	
Clear	Clock	D	Q	\bar{Q}
L	X	X	L	H
H		H	H	L
H		L	L	H
H	L	X	no change	

H : High level

L : Low level

X : Irrelevant

Pin Arrangement

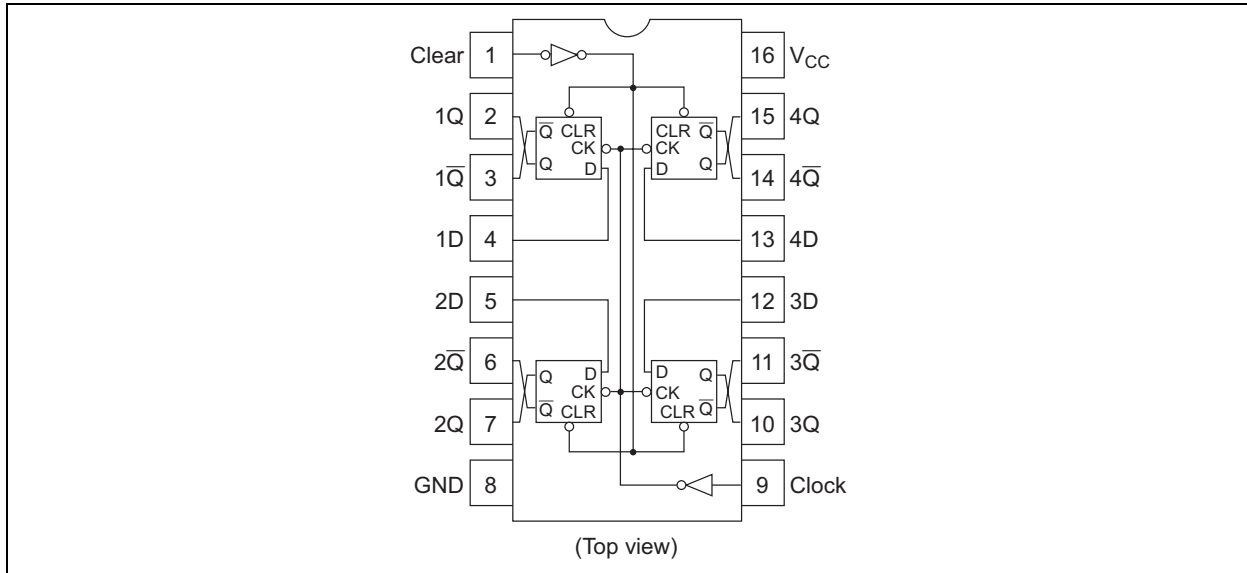

Logic Diagram

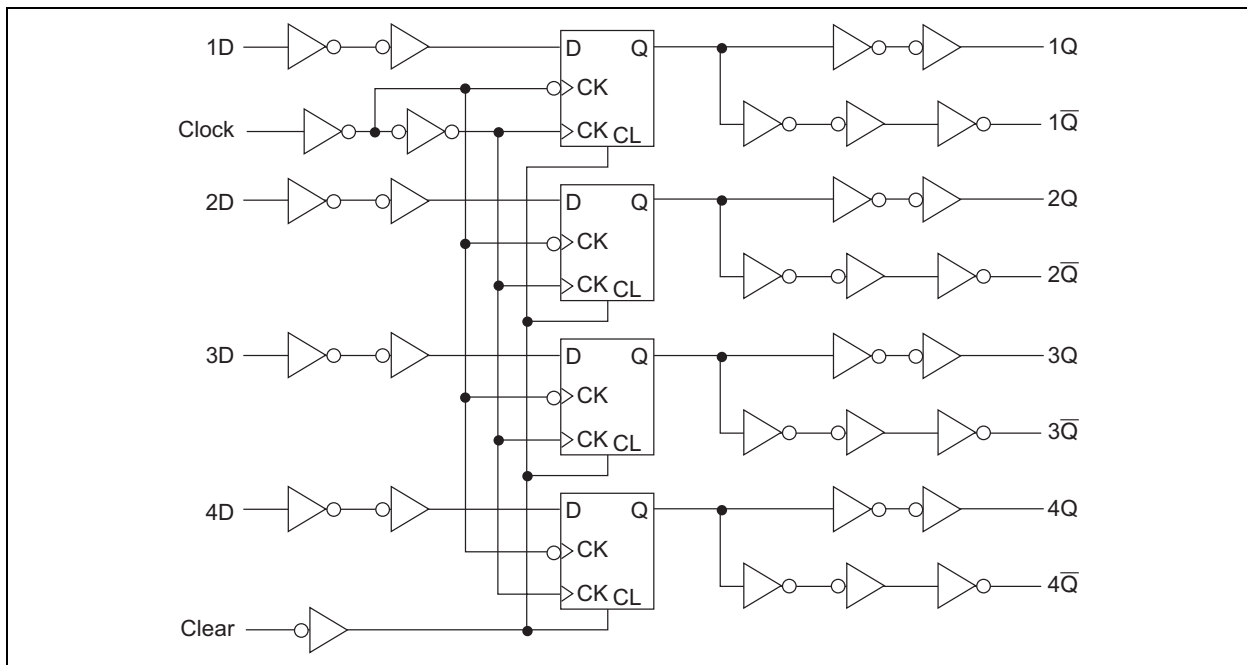

Absolute Maximum Ratings

Item	Symbol	Ratings	Unit
Supply voltage range	V_{CC}	-0.5 to 7.0	V
Input / Output voltage	V_{in}, V_{out}	-0.5 to $V_{CC} + 0.5$	V
Input / Output diode current	I_{IK}, I_{OK}	± 20	mA
Output current	I_O	± 25	mA
V_{CC} , GND current	I_{CC} or I_{GND}	± 50	mA
Power dissipation	P_T	500	mW
Storage temperature	T_{stg}	-65 to +150	°C

Note: The absolute maximum ratings are values, which must not individually be exceeded, and furthermore, no two of which may be realized at the same time.

Recommended Operating Conditions

Item	Symbol	Ratings	Unit	Conditions
Supply voltage	V_{CC}	2 to 6	V	
Input / Output voltage	V_{IN}, V_{OUT}	0 to V_{CC}	V	
Operating temperature	T_a	-40 to 85	°C	
Input rise / fall time ^{*1}	t_r, t_f	0 to 1000	ns	$V_{CC} = 2.0$ V
		0 to 500		$V_{CC} = 4.5$ V
		0 to 400		$V_{CC} = 6.0$ V

Note: 1. This item guarantees maximum limit when one input switches.

Waveform: Refer to test circuit of switching characteristics.

Electrical Characteristics

Item	Symbol	V_{CC} (V)	$T_a = 25^\circ\text{C}$			$T_a = -40 \text{ to } +85^\circ\text{C}$		Unit	Test Conditions	
			Min	Typ	Max	Min	Max			
Input voltage	V_{IH}	2.0	1.5	—	—	1.5	—	V		
		4.5	3.15	—	—	3.15	—			
		6.0	4.2	—	—	4.2	—			
	V_{IL}	2.0	—	—	0.5	—	0.5	V		
		4.5	—	—	1.35	—	1.35			
		6.0	—	—	1.8	—	1.8			
Output voltage	V_{OH}	2.0	1.9	2.0	—	1.9	—	V	$V_{in} = V_{IH}$ or V_{IL}	$I_{OH} = -20 \mu\text{A}$
		4.5	4.4	4.5	—	4.4	—			$I_{OH} = -4 \text{ mA}$
		6.0	5.9	6.0	—	5.9	—			$I_{OH} = -5.2 \text{ mA}$
		4.5	4.18	—	—	4.13	—			
		6.0	5.68	—	—	5.63	—			
	V_{OL}	2.0	—	0.0	0.1	—	0.1	V	$V_{in} = V_{IH}$ or V_{IL}	$I_{OL} = 20 \mu\text{A}$
		4.5	—	0.0	0.1	—	0.1			
		6.0	—	0.0	0.1	—	0.1			
		4.5	—	—	0.26	—	0.33			$I_{OL} = 4 \text{ mA}$
		6.0	—	—	0.26	—	0.33			$I_{OL} = 5.2 \text{ mA}$
Input current	I_{in}	6.0	—	—	± 0.1	—	± 1.0	μA	$V_{in} = V_{CC}$ or GND	
Quiescent supply current	I_{CC}	6.0	—	—	4.0	—	40	μA	$V_{in} = V_{CC}$ or GND, $I_{out} = 0 \mu\text{A}$	

Switching Characteristics

 $(C_L = 50 \text{ pF, Input } t_r = t_f = 6 \text{ ns})$

Item	Symbol	V _{CC} (V)	Ta = 25°C			Ta = -40 to +85°C		Unit	Test Conditions
			Min	Typ	Max	Min	Max		
Maximum clock frequency	f _{max}	2.0	—	—	6	—	5	MHz	
		4.5	—	—	30	—	24		
		6.0	—	—	35	—	28		
Propagation delay time	t _{PLH} , t _{PHL}	2.0	—	—	150	—	190	ns	Clock to Q or \bar{Q}
		4.5	—	14	30	—	38		
		6.0	—	—	26	—	33		
		2.0	—	—	185	—	230	ns	Clear to Q or \bar{Q}
		4.5	—	14	37	—	46		
		6.0	—	—	31	—	39		
Setup time	t _{su}	2.0	100	—	—	125	—	ns	Data to Clock
		4.5	20	3	—	25	—		
		6.0	17	—	—	21	—		
Hold time	t _h	2.0	5	—	—	5	—	ns	Clock to Data
		4.5	5	-1	—	5	—		
		6.0	5	—	—	5	—		
Removal time	t _{rem}	2.0	100	—	—	125	—	ns	Clear to Clock
		4.5	20	-1	—	25	—		
		6.0	17	—	—	21	—		
Pulse width	t _w	2.0	80	—	—	100	—	ns	Clock, Clear
		4.5	16	9	—	20	—		
		6.0	14	—	—	17	—		
Output rise/fall time	t _{TLH} , t _{THL}	2.0	—	—	75	—	95	ns	
		4.5	—	5	15	—	19		
		6.0	—	—	13	—	16		
Input capacitance	C _{in}	—	—	5	10	—	10	pF	

Test Circuit

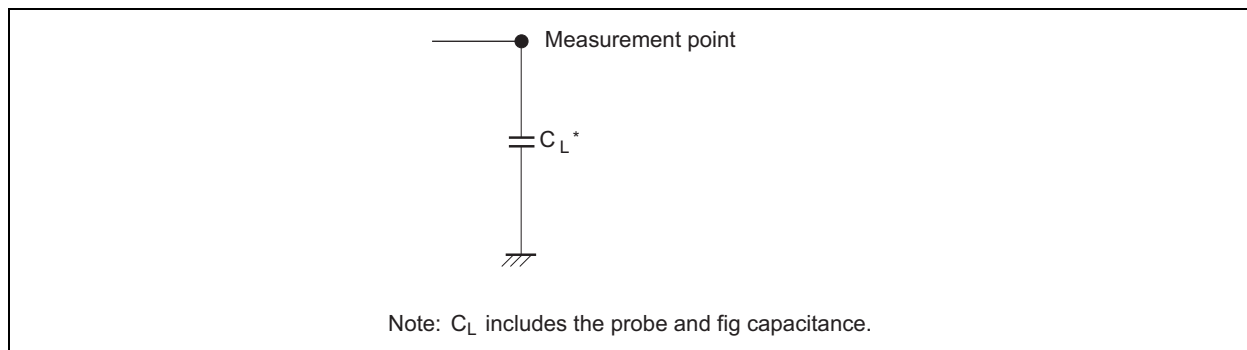

Waveforms

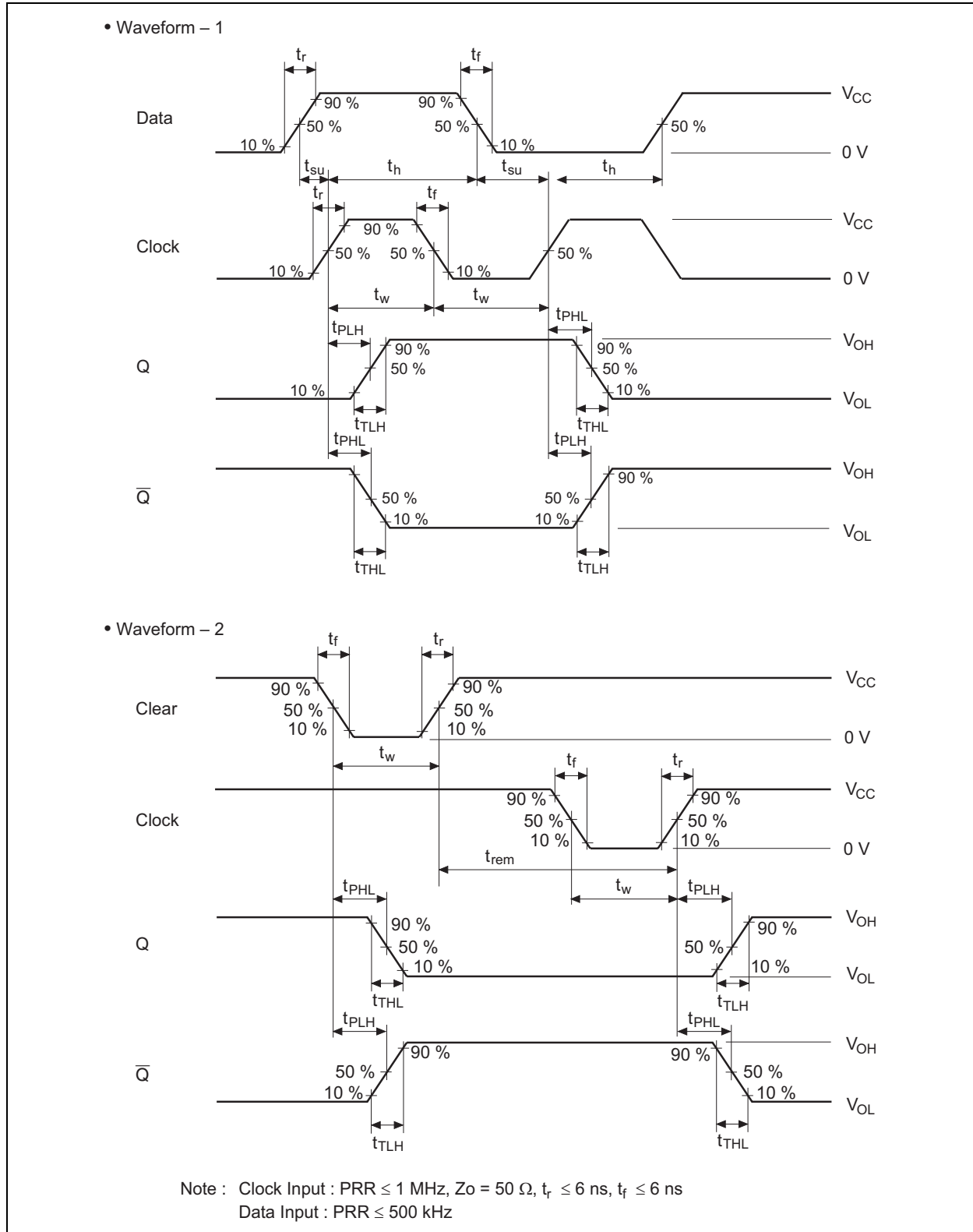

Package Dimensions

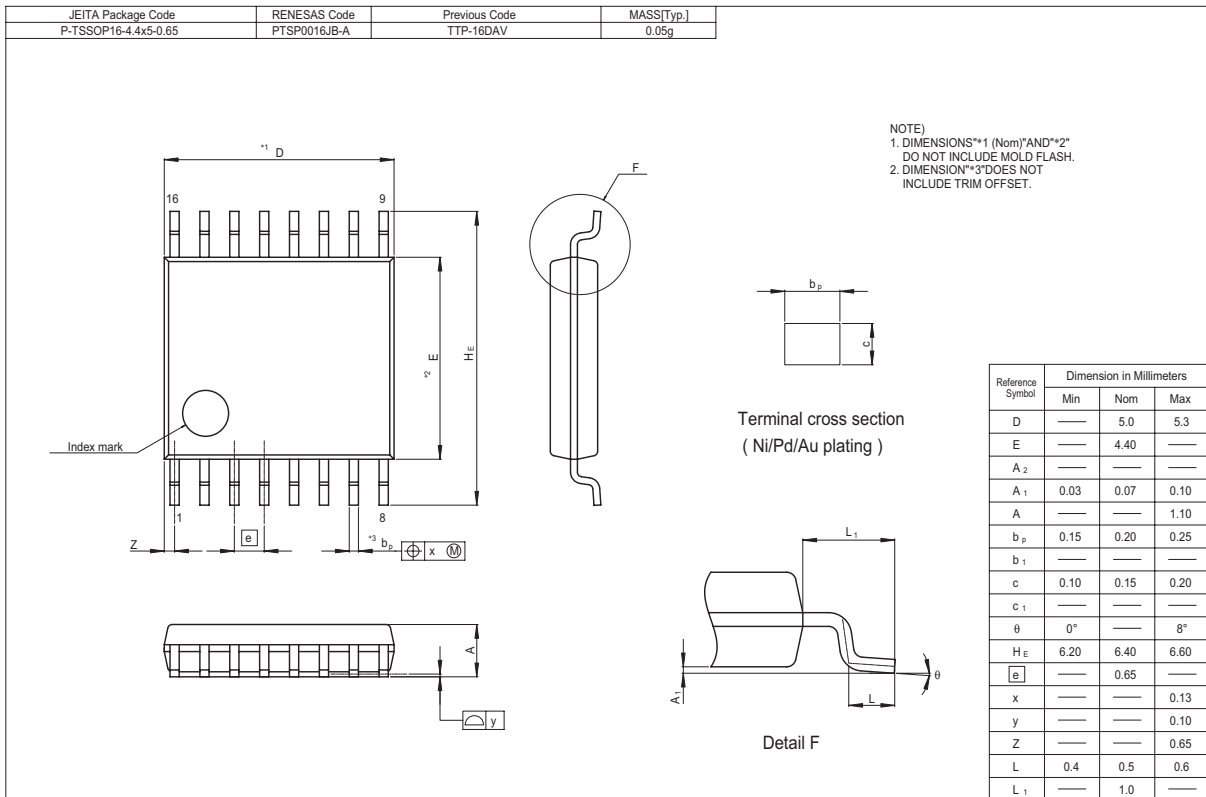
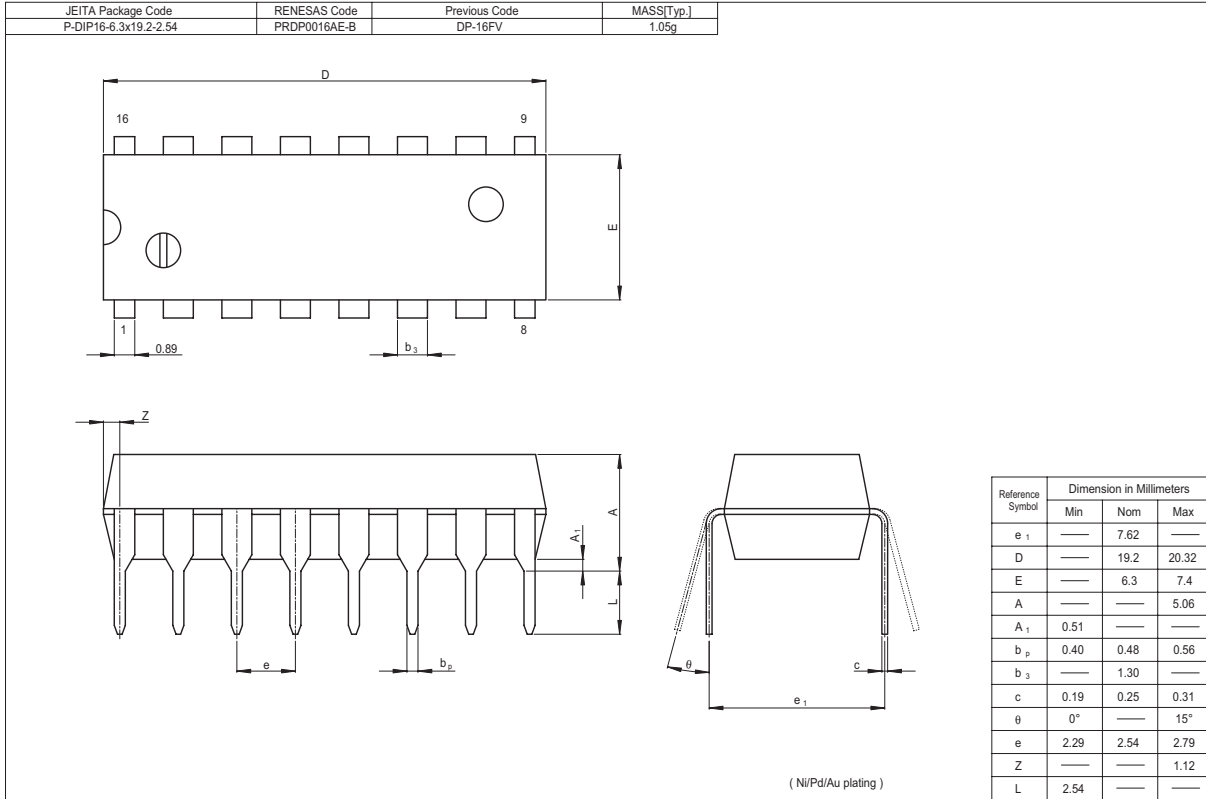

Renesas Technology Corp. Sales Strategic Planning Div. Nippon Bldg., 2-6-2, Ohte-machi, Chiyoda-ku, Tokyo 100-0004, Japan

Keep safety first in your circuit designs!

1. Renesas Technology Corp. puts the maximum effort into making semiconductor products better and more reliable, but there is always the possibility that trouble may occur with them. Trouble with semiconductors may lead to personal injury, fire or property damage.
Remember to give due consideration to safety when making your circuit designs, with appropriate measures such as (i) placement of substitutive, auxiliary circuits, (ii) use of nonflammable material or (iii) prevention against any malfunction or mishap.

Notes regarding these materials

1. These materials are intended as a reference to assist our customers in the selection of the Renesas Technology Corp. product best suited to the customer's application; they do not convey any license under any intellectual property rights, or any other rights, belonging to Renesas Technology Corp. or a third party.
2. Renesas Technology Corp. assumes no responsibility for any damage, or infringement of any third-party's rights, originating in the use of any product data, diagrams, charts, programs, algorithms, or circuit application examples contained in these materials.
3. All information contained in these materials, including product data, diagrams, charts, programs and algorithms represents information on products at the time of publication of these materials, and are subject to change by Renesas Technology Corp. without notice due to product improvements or other reasons. It is therefore recommended that customers contact Renesas Technology Corp. or an authorized Renesas Technology Corp. product distributor for the latest product information before purchasing a product listed herein.
The information described here may contain technical inaccuracies or typographical errors.
Renesas Technology Corp. assumes no responsibility for any damage, liability, or other loss rising from these inaccuracies or errors.
Please also pay attention to information published by Renesas Technology Corp. by various means, including the Renesas Technology Corp. Semiconductor home page (<http://www.renesas.com>).
4. When using any or all of the information contained in these materials, including product data, diagrams, charts, programs, and algorithms, please be sure to evaluate all information as a total system before making a final decision on the applicability of the information and products. Renesas Technology Corp. assumes no responsibility for any damage, liability or other loss resulting from the information contained herein.
5. Renesas Technology Corp. semiconductors are not designed or manufactured for use in a device or system that is used under circumstances in which human life is potentially at stake. Please contact Renesas Technology Corp. or an authorized Renesas Technology Corp. product distributor when considering the use of a product contained herein for any specific purposes, such as apparatus or systems for transportation, vehicular, medical, aerospace, nuclear, or undersea repeater use.
6. The prior written approval of Renesas Technology Corp. is necessary to reprint or reproduce in whole or in part these materials.
7. If these products or technologies are subject to the Japanese export control restrictions, they must be exported under a license from the Japanese government and cannot be imported into a country other than the approved destination.
Any diversion or reexport contrary to the export control laws and regulations of Japan and/or the country of destination is prohibited.
8. Please contact Renesas Technology Corp. for further details on these materials or the products contained therein.



RENESAS SALES OFFICES

<http://www.renesas.com>

Refer to "<http://www.renesas.com/en/network>" for the latest and detailed information.

Renesas Technology America, Inc.

450 Holger Way, San Jose, CA 95134-1368, U.S.A
Tel: <1> (408) 382-7500, Fax: <1> (408) 382-7501

Renesas Technology Europe Limited

Dukes Meadow, Millboard Road, Bourne End, Buckinghamshire, SL8 5FH, U.K.
Tel: <44> (1628) 585-100, Fax: <44> (1628) 585-900

Renesas Technology (Shanghai) Co., Ltd.

Unit 204, 205, AZIACenter, No.1233 Lujiazui Ring Rd, Pudong District, Shanghai, China 200120
Tel: <86> (21) 5877-1818, Fax: <86> (21) 6887-7898

Renesas Technology Hong Kong Ltd.

7th Floor, North Tower, World Finance Centre, Harbour City, 1 Canton Road, Tsimshatsui, Kowloon, Hong Kong
Tel: <852> 2265-6688, Fax: <852> 2730-6071

Renesas Technology Taiwan Co., Ltd.

10th Floor, No.99, Fushing North Road, Taipei, Taiwan
Tel: <886> (2) 2715-2888, Fax: <886> (2) 2713-2999

Renesas Technology Singapore Pte. Ltd.

1 Harbour Front Avenue, #06-10, Keppel Bay Tower, Singapore 098632
Tel: <65> 6213-0200, Fax: <65> 6278-8001

Renesas Technology Korea Co., Ltd.

Kukje Center Bldg. 18th Fl., 191, 2-ka, Hangang-ro, Yongsan-ku, Seoul 140-702, Korea
Tel: <82> (2) 796-3115, Fax: <82> (2) 796-2145

Renesas Technology Malaysia Sdn. Bhd

Unit 906, Block B, Menara Amcorp, Amcorp Trade Centre, No.18, Jalan Persiaran Barat, 46050 Petaling Jaya, Selangor Darul Ehsan, Malaysia
Tel: <603> 7955-9390, Fax: <603> 7955-9510