

GENERAL FEATURES

●N-Channel

$V_{DS} = 20V, I_D = 4.5A$
 $R_{DS(ON)} < 40m\Omega @ V_{GS}=2.5V$
 $R_{DS(ON)} < 30m\Omega @ V_{GS}=4.5V$

●P-Channel

$V_{DS} = -20V, I_D = -3.5A$
 $R_{DS(ON)} < 85m\Omega @ V_{GS}=-2.5V$
 $R_{DS(ON)} < 50m\Omega @ V_{GS}=-4.5V$

- High Power and current handling capability
- Lead free product is acquired
- Surface Mount Package

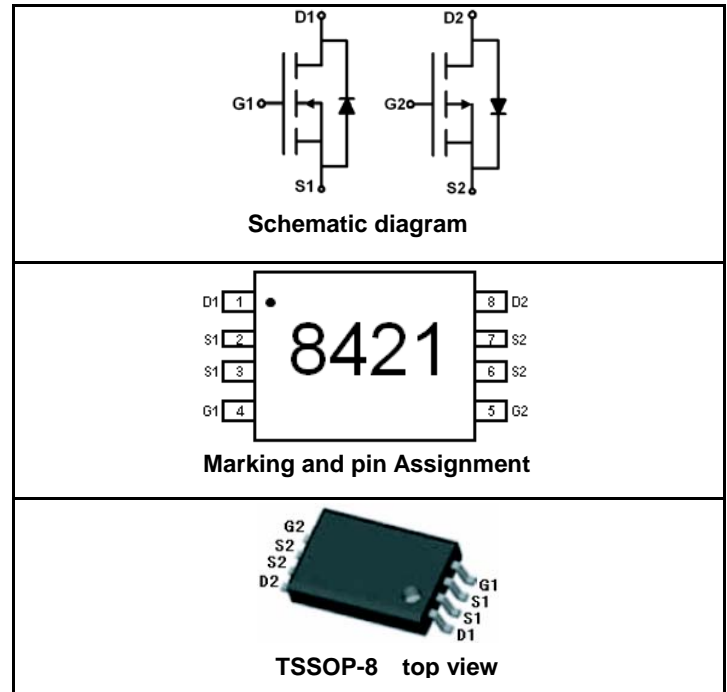

PACKAGE MARKING AND ORDERING INFORMATION

Device Marking	Device	Device Package	Reel Size	Tape width	Quantity
8421	SSF8421	TSSOP-8	Ø330mm	12mm	3000 units

ABSOLUTE MAXIMUM RATINGS(TA=25°C unless otherwise noted)

Parameter	Symbol	N-Channel	P-Channel	Unit
Drain-Source Voltage	V_{DS}	20	-20	V
Gate-Source Voltage	V_{GS}	±12	±12	V
Drain Current-Continuous@Current-Pulsed (Note 1)	I_D	4.5	-3.5	A
	I_{DM}	30	-30	A
Maximum Power Dissipation	P_D	1.0	1.0	W
Operating Junction and Storage Temperature Range	T_J, T_{STG}	-55 To 150	-55 To 150	°C

THERMAL CHARACTERISTICS

Thermal Resistance, Junction-to-Ambient (Note2)	$R_{\theta JA}$	N-Ch	83	°C/W
		P-Ch	100	

ELECTRICAL CHARACTERISTICS (TA=25°C unless otherwise noted)

Parameter	Symbol	Condition	Min	Typ	Max	Unit
-----------	--------	-----------	-----	-----	-----	------

OFF CHARACTERISTICS

Drain-Source Breakdown Voltage	BV_{DSS}	$V_{GS}=0V, I_D=250\mu A$	N-Ch	20			V
		$V_{GS}=0V, I_D=-250\mu A$	P-Ch	-20			
Zero Gate Voltage Drain Current	I_{DSS}	$V_{DS}=20V, V_{GS}=0V$	N-Ch			1	μA
		$V_{DS}=-20V, V_{GS}=0V$	P-Ch			-1	
Gate-Body Leakage Current	I_{GSS}	$V_{GS}=\pm 12V, V_{DS}=0V$	N-Ch			± 100	nA
			P-Ch			± 100	

ON CHARACTERISTICS (Note 3)

Gate Threshold Voltage	$V_{GS(th)}$	$V_{DS}=V_{GS}, I_D=250\mu A$	N-Ch	0.6			V
		$V_{DS}=V_{GS}, I_D=-250\mu A$	P-Ch	-0.6			
Drain-Source On-State Resistance	$R_{DS(on)}$	$V_{GS}=4.5V, I_D=4.5A$	N-Ch		23	30	m Ω
		$V_{GS}=-4.5V, I_D=-3.5A$	P-Ch		40	50	
		$V_{GS}=2.5V, I_D=3.9A$	N-Ch		30	40	
		$V_{GS}=-2.5V, I_D=-2.7A$	P-Ch		60	85	
Forward Transconductance	g_{FS}	$V_{DS}=10V, I_D=4.5A$	N-Ch		20		S
		$V_{DS}=-10V, I_D=-3.5A$	P-Ch		10		

SWITCHING CHARACTERISTICS (Note 4)

Turn-on Delay Time	$t_{d(on)}$	<p>N-Ch $V_{DD}=10V, I_D=1A$ $V_{GEN}=10V, R_{GEN}=6\Omega$</p> <p>P-Ch $V_{DD}=-10V, I_D=-1A$ $V_{GEN}=-10V, R_{GEN}=6\Omega$</p>	N-Ch		22	50	nS
			P-Ch		27	50	
Turn-on Rise Time	t_r		N-Ch		40	80	nS
			P-Ch		30	60	
Turn-Off Delay Time	$t_{d(off)}$		N-Ch		50	100	nS
			P-Ch		55	100	
Turn-Off Fall Time	t_f		N-Ch		20	40	nS
			P-Ch		21	40	
Total Gate Charge	Q_g		N-Ch		10	20	nC
			P-Ch		14	25	
Gate-Source Charge	Q_{gs}	N-Ch		2.5		nC	
		P-Ch		3.5			
Gate-Drain Charge	Q_{gd}	N-Ch		3.0		nC	
		P-Ch		3.5			

DRAIN-SOURCE DIODE CHARACTERISTICS

Diode Forward Voltage (Note 3)	V_{SD}	$V_{GS}=0V, I_S=1.25A$	N-Ch		1.2	V
		$V_{GS}=0V, I_S=-1.25A$	P-Ch		-1.2	V

NOTES:

1. Repetitive Rating: Pulse width limited by maximum junction temperature.
2. Surface Mounted on FR4 Board, $t \leq 10$ sec.
3. Pulse Test: Pulse Width $\leq 300\mu s$, Duty Cycle $\leq 2\%$.
4. Guaranteed by design, not subject to production testing.

N-Channel THERMAL CHARACTERISTICS

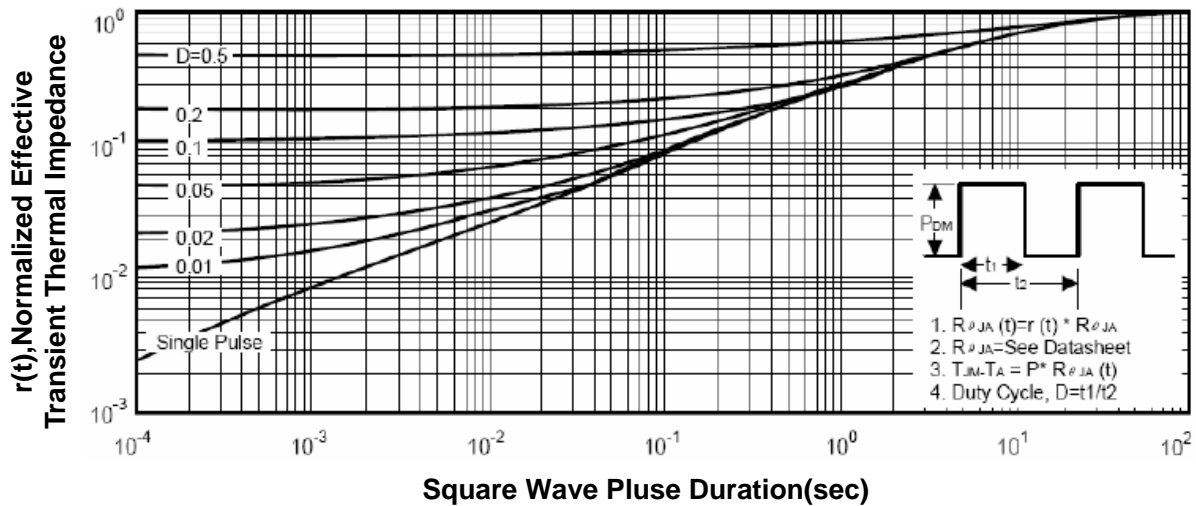

Figure 1: Normalized Maximum Transient Thermal Impedance

P-Channel THERMAL CHARACTERISTICS

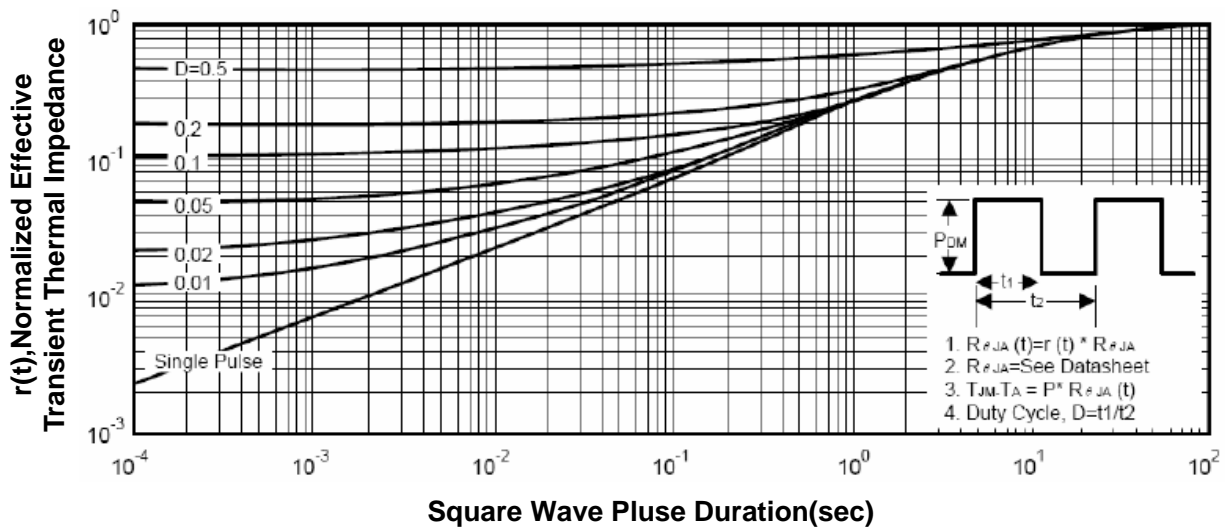
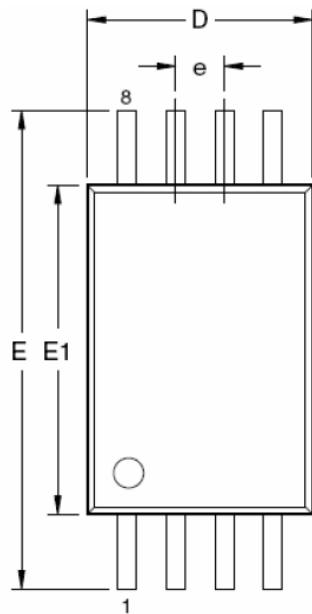
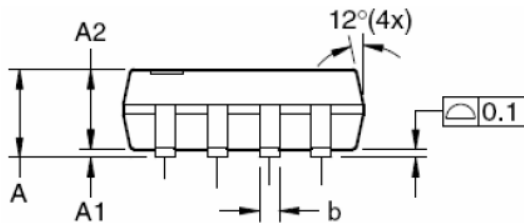
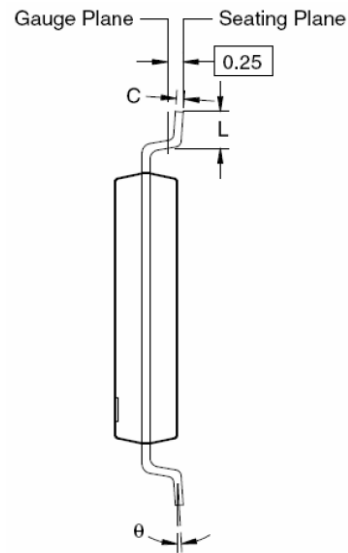

Figure 2: Normalized Maximum Transient Thermal Impedance

TSSOP-8 PACKAGE INFORMATION



Dimensions in Millimeters (UNIT:mm)



RECOMMENDED LAND PATTERN

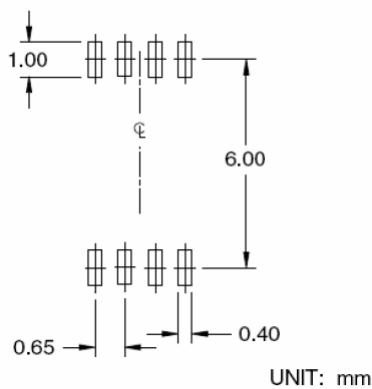

UNIT: mm

Dimensions in millimeters

Symbols	Min.	Nom.	Max.
A	—	—	1.20
A1	0.05	—	0.15
A2	0.80	1.00	1.05
b	0.19	—	0.30
C	0.09	—	0.20
D	2.90	3.00	3.10
E	6.40 BSC		
E1	4.30	4.40	4.50
e	0.65 BSC		
L	0.45	0.60	0.75
θ	0°	—	8°

Dimensions in inches

Symbols	Min.	Nom.	Max.
A	—	—	0.047
A1	0.002	—	0.006
A2	0.031	0.039	0.041
b	0.007	—	0.012
C	0.004	—	0.008
D	0.114	0.118	0.122
E	0.252 BSC		
E1	0.169	0.173	0.177
e	0.026 BSC		
L	0.018	0.024	0.030
θ	0°	—	8°

NOTES:

1. All dimensions are in millimeters.
2. Dimensions are inclusive of plating
3. Package body sizes exclude mold flash and gate burrs. Mold flash at the non-lead sides should be less than 6 mils.
4. Dimension L is measured in gauge plane.
5. Controlling dimension is millimeter, converted inch dimensions are not necessarily exact.