

# MC14070B, MC14077B

## CMOS SSI

### Quad Exclusive "OR" and "NOR" Gates

The MC14070B quad exclusive OR gate and the MC14077B quad exclusive NOR gate are constructed with MOS P-channel and N-channel enhancement mode devices in a single monolithic structure. These complementary MOS logic gates find primary use where low power dissipation and/or high noise immunity is desired.

#### Features

- Supply Voltage Range = 3.0 Vdc to 18 Vdc
- All Outputs Buffered
- Capable of Driving Two Low-Power TTL Loads or One Low-Power Schottky TTL Load Over the Rated Temperature Range
- Double Diode Protection on All Inputs
- MC14070B – Replacement for CD4030B and CD4070B Types
- MC14077B – Replacement for CD4077B Type
- Pb-Free Packages are Available

#### MAXIMUM RATINGS (Voltages Referenced to $V_{SS}$ )

Symbol	Parameter	Value	Unit
$V_{DD}$	DC Supply Voltage Range	-0.5 to +18.0	V
$V_{in}, V_{out}$	Input or Output Voltage Range (DC or Transient)	-0.5 to $V_{DD} + 0.5$	V
$I_{in}, I_{out}$	Input or Output Current (DC or Transient) per Pin	$\pm 10$	mA
$P_D$	Power Dissipation, per Package (Note 1)	500	mW
$T_A$	Ambient Temperature Range	-55 to +125	$^{\circ}C$
$T_{stg}$	Storage Temperature Range	-65 to +150	$^{\circ}C$
$T_L$	Lead Temperature (8-Second Soldering)	260	$^{\circ}C$

Stresses exceeding Maximum Ratings may damage the device. Maximum Ratings are stress ratings only. Functional operation above the Recommended Operating Conditions is not implied. Extended exposure to stresses above the Recommended Operating Conditions may affect device reliability.

#### 1. Temperature Derating:

Plastic "P and D/DW" Packages: - 7.0 mW/ $^{\circ}C$  From 65 $^{\circ}C$  To 125 $^{\circ}C$

This device contains protection circuitry to guard against damage due to high static voltages or electric fields. However, precautions must be taken to avoid applications of any voltage higher than maximum rated voltages to this high-impedance circuit. For proper operation,  $V_{in}$  and  $V_{out}$  should be constrained to the range  $V_{SS} \leq (V_{in} \text{ or } V_{out}) \leq V_{DD}$ .

Unused inputs must always be tied to an appropriate logic voltage level (e.g., either  $V_{SS}$  or  $V_{DD}$ ). Unused outputs must be left open.



ON Semiconductor®

<http://onsemi.com>

#### MARKING DIAGRAMS

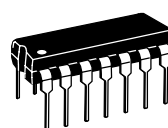

PDIP-14  
P SUFFIX  
CASE 646

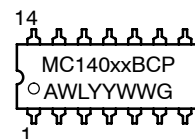

SOIC-14  
D SUFFIX  
CASE 751A

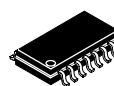
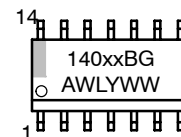

SOEIAJ-14  
F SUFFIX  
CASE 965

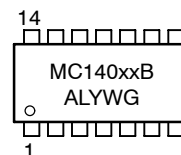

xx = Specific Device Code  
A = Assembly Location  
WL, L = Wafer Lot  
YY, Y = Year  
WW, W = Work Week  
G = Pb-Free Package

#### ORDERING INFORMATION

See detailed ordering and shipping information in the package dimensions section on page 3 of this data sheet.

# MC14070B, MC14077B

## PIN ASSIGNMENT

IN 1 <sub>A</sub>	1	14	V <sub>DD</sub>
IN 2 <sub>A</sub>	2	13	IN 2 <sub>D</sub>
OUT <sub>A</sub>	3	12	IN 1 <sub>D</sub>
OUT <sub>B</sub>	4	11	OUT <sub>D</sub>
IN 1 <sub>B</sub>	5	10	OUT <sub>C</sub>
IN 2 <sub>B</sub>	6	9	IN 2 <sub>C</sub>
V <sub>SS</sub>	7	8	IN 1 <sub>C</sub>

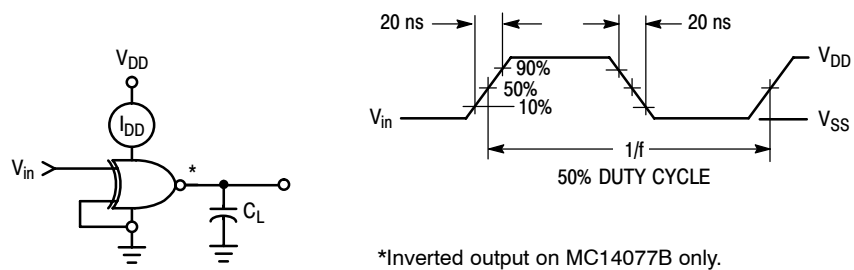
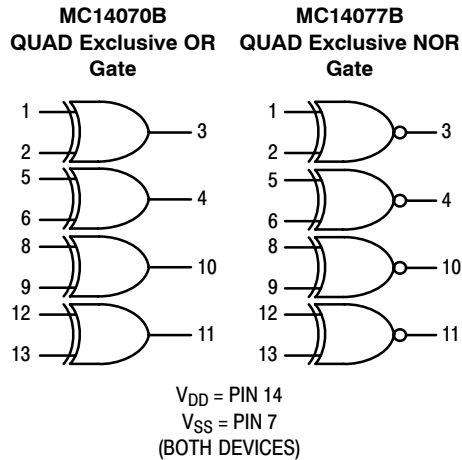

**Figure 1. Power Dissipation Test Circuit and Waveform**

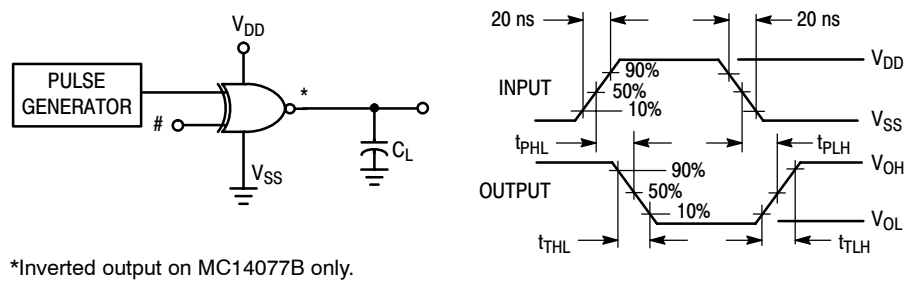

**Figure 2. Switching Time Test Circuit and Waveforms**

## MC14070B, MC14077B

### ORDERING INFORMATION

Device	Package	Shipping†
MC14070BCP	PDIP-14	25 Units / Rail
MC14070BCPG	PDIP-14 (Pb-Free)	
MC14070BD	SOIC-14	55 Units / Rail
MC14070BDG	SOIC-14 (Pb-Free)	
MC14070BDR2	SOIC-14	2500 / Tape & Reel
MC14070BDR2G	SOIC-14 (Pb-Free)	
MC14070BFEL	SOEIAJ-14	2000 / Tape & Reel
MC14070BFELG	SOEIAJ-14 (Pb-Free)	
MC14077BCP	PDIP-14	25 Units / Rail
MC14077BCPG	PDIP-14 (Pb-Free)	
MC14077BD	SOIC-14	55 Units / Rail
MC14077BDG	SOIC-14 (Pb-Free)	
MC14077BDR2	SOIC-14	2500 / Tape & Reel
MC14077BDR2G	SOIC-14 (Pb-Free)	
MC14077BFEL	SOEIAJ-14	2000 / Tape & Reel
MC14077BFELG	SOEIAJ-14 (Pb-Free)	

†For information on tape and reel specifications, including part orientation and tape sizes, please refer to our Tape and Reel Packaging Specifications Brochure, BRD8011/D.

# MC14070B, MC14077B

## ELECTRICAL CHARACTERISTICS (Voltages Referenced to V<sub>SS</sub>)

Characteristic	Symbol	V <sub>DD</sub> Vdc	- 55°C		25°C			125°C		Unit
			Min	Max	Min	Typ (Note 2)	Max	Min	Max	
Output Voltage V <sub>in</sub> = V <sub>DD</sub> or 0  V <sub>in</sub> = 0 or V <sub>DD</sub>	"0" Level  V <sub>OL</sub>	5.0	-	0.05	-	0	0.05	-	0.05	Vdc
		10	-	0.05	-	0	0.05	-	0.05	
		15	-	0.05	-	0	0.05	-	0.05	
	"1" Level  V <sub>OH</sub>	5.0	4.95	-	4.95	5.0	-	4.95	-	Vdc
		10	9.95	-	9.95	10	-	9.95	-	
		15	14.95	-	14.95	15	-	14.95	-	
Input Voltage (V <sub>O</sub> = 4.5 or 0.5 Vdc) (V <sub>O</sub> = 9.0 or 1.0 Vdc) (V <sub>O</sub> = 13.5 or 1.5 Vdc)  (V <sub>O</sub> = 0.5 or 4.5 Vdc) (V <sub>O</sub> = 1.0 or 9.0 Vdc) (V <sub>O</sub> = 1.5 or 13.5 Vdc)	"0" Level  V <sub>IL</sub>	5.0	-	1.5	-	2.25	1.5	-	1.5	Vdc
		10	-	3.0	-	4.50	3.0	-	3.0	
		15	-	4.0	-	6.75	4.0	-	4.0	
	"1" Level  V <sub>IH</sub>	5.0	3.5	-	3.5	2.75	-	3.5	-	Vdc
		10	7.0	-	7.0	5.50	-	7.0	-	
		15	11	-	11	8.25	-	11	-	
Output Drive Current (V <sub>OH</sub> = 2.5 Vdc) (V <sub>OH</sub> = 4.6 Vdc) (V <sub>OH</sub> = 9.5 Vdc) (V <sub>OH</sub> = 13.5 Vdc)  (V <sub>OL</sub> = 0.4 Vdc) (V <sub>OL</sub> = 0.5 Vdc) (V <sub>OL</sub> = 1.5 Vdc)	Source  I <sub>OH</sub>	5.0	-3.0	-	-2.4	-4.2	-	-1.7	-	mAdc
		5.0	-0.64	-	-0.51	-0.88	-	-0.36	-	
		10	-1.6	-	-1.3	-2.25	-	-0.9	-	
	Sink  I <sub>OL</sub>	5.0	0.64	-	0.51	0.88	-	0.36	-	mAdc
		10	1.6	-	1.3	2.25	-	0.9	-	
		15	4.2	-	3.4	8.8	-	2.4	-	
Input Current	I <sub>in</sub>	15	-	± 0.1	-	± 0.00001	± 0.1	-	± 1.0	μAdc
Input Capacitance (V <sub>in</sub> = 0)	C <sub>in</sub>	-	-	-	-	5.0	7.5	-	-	pF
Quiescent Current (Per Package)	I <sub>DD</sub>	5.0	-	0.25	-	0.0005	0.25	-	7.5	μAdc
		10	-	0.5	-	0.0010	0.5	-	15	
		15	-	1.0	-	0.0015	1.0	-	30	
Total Supply Current (Notes 3 & 4) (Dynamic plus Quiescent, Per Package) (C <sub>L</sub> = 50 pF on all outputs, all buffers switching)	I <sub>T</sub>	5.0	I <sub>T</sub> = (0.3 μA/kHz) f + I <sub>DD</sub>							μAdc
		10	I <sub>T</sub> = (0.6 μA/kHz) f + I <sub>DD</sub>							
		15	I <sub>T</sub> = (0.9 μA/kHz) f + I <sub>DD</sub>							
Output Rise and Fall Times (Note 3) (C <sub>L</sub> = 50 pF) t <sub>TLH</sub> , t <sub>THL</sub> = (1.35 ns/pF) C <sub>L</sub> + 33 ns t <sub>TLH</sub> , t <sub>THL</sub> = (0.60 ns/pF) C <sub>L</sub> + 20 ns t <sub>TLH</sub> , t <sub>THL</sub> = (0.40 ns/pF) C <sub>L</sub> + 20 ns	t <sub>TLH</sub> , t <sub>THL</sub>	5.0	-	-	-	100	200	-	-	ns
		10	-	-	-	50	100	-	-	
		15	-	-	-	40	80	-	-	
Propagation Delay Times (Note 3) (C <sub>L</sub> = 50 pF) t <sub>PLH</sub> , t <sub>PHL</sub> = (0.90 ns/pF) C <sub>L</sub> + 130 ns t <sub>PLH</sub> , t <sub>PHL</sub> = (0.36 ns/pF) C <sub>L</sub> + 57 ns t <sub>PLH</sub> , t <sub>PHL</sub> = (0.26 ns/pF) C <sub>L</sub> + 37 ns	t <sub>PLH</sub> , t <sub>PHL</sub>	5.0	-	-	-	175	350	-	-	ns
		10	-	-	-	75	150	-	-	
		15	-	-	-	55	110	-	-	

2. Data labelled "Typ" is not to be used for design purposes but is intended as an indication of the IC's potential performance.

3. The formulas given are for the typical characteristics only at 25°C.

4. To calculate total supply current at loads other than 50 pF:

$$I_T(C_L) = I_T(50 \text{ pF}) + (C_L - 50) V f k$$

where: I<sub>T</sub> is in μH (per package), C<sub>L</sub> in pF, V = (V<sub>DD</sub> - V<sub>SS</sub>) in volts, f in kHz is input frequency, and k = 0.002.

# MC14070B, MC14077B

## PACKAGE DIMENSIONS

**PDIP-14**  
CASE 646-06  
ISSUE P

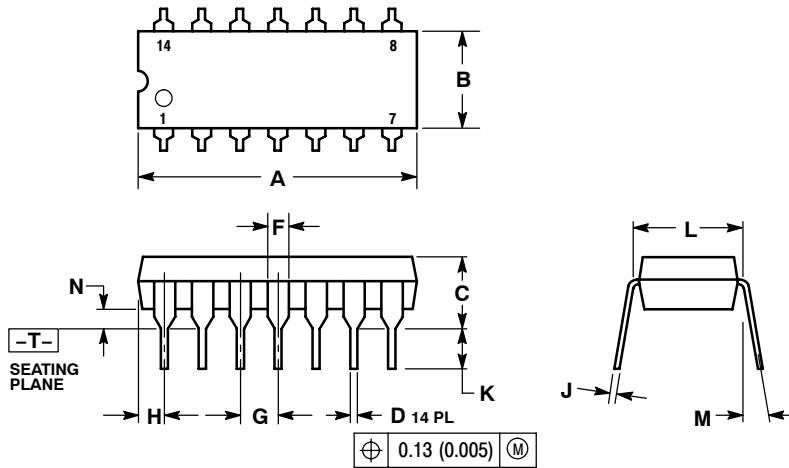

**NOTES:**

1. DIMENSIONING AND TOLERANCING PER ANSI Y14.5M, 1982.
2. CONTROLLING DIMENSION: INCH.
3. DIMENSION L TO CENTER OF LEADS WHEN FORMED PARALLEL.
4. DIMENSION B DOES NOT INCLUDE MOLD FLASH.
5. ROUNDED CORNERS OPTIONAL.

DIM	INCHES		MILLIMETERS	
	MIN	MAX	MIN	MAX
A	0.715	0.770	18.16	19.56
B	0.240	0.260	6.10	6.60
C	0.145	0.185	3.69	4.69
D	0.015	0.021	0.38	0.53
F	0.040	0.070	1.02	1.78
G	0.100 BSC		2.54 BSC	
H	0.052	0.095	1.32	2.41
J	0.008	0.015	0.20	0.38
K	0.115	0.135	2.92	3.43
L	0.290	0.310	7.37	7.87
M	---	10°	---	10°
N	0.015	0.039	0.38	1.01

# MC14070B, MC14077B

## PACKAGE DIMENSIONS

SOIC-14  
CASE 751A-03  
ISSUE H

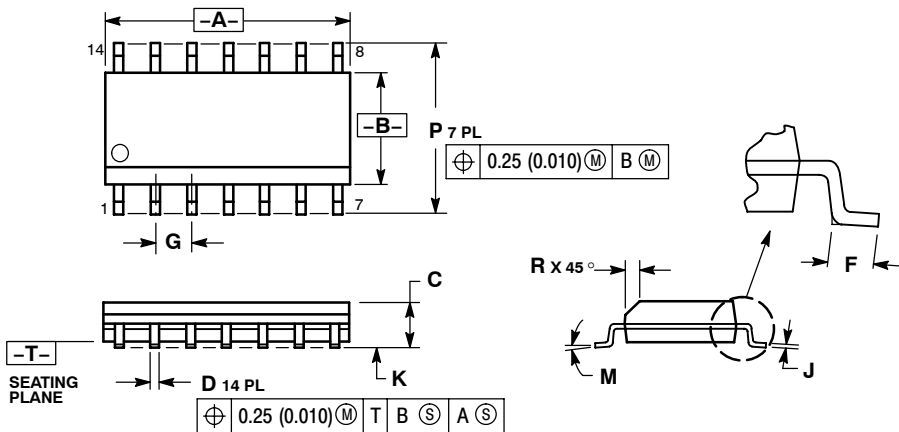

- NOTES:
1. DIMENSIONING AND TOLERANCING PER ANSI Y14.5M, 1982.
  2. CONTROLLING DIMENSION: MILLIMETER.
  3. DIMENSIONS A AND B DO NOT INCLUDE MOLD PROTRUSION.
  4. MAXIMUM MOLD PROTRUSION 0.15 (0.006) PER SIDE.
  5. DIMENSION D DOES NOT INCLUDE DAMBAR PROTRUSION. ALLOWABLE DAMBAR PROTRUSION SHALL BE 0.127 (0.005) TOTAL IN EXCESS OF THE D DIMENSION AT MAXIMUM MATERIAL CONDITION.

DIM	MILLIMETERS		INCHES	
	MIN	MAX	MIN	MAX
A	8.55	8.75	0.337	0.344
B	3.80	4.00	0.150	0.157
C	1.35	1.75	0.054	0.068
D	0.35	0.49	0.014	0.019
F	0.40	1.25	0.016	0.049
G	1.27 BSC		0.050 BSC	
J	0.19	0.25	0.008	0.009
K	0.10	0.25	0.004	0.009
M	0°	7°	0°	7°
P	5.80	6.20	0.228	0.244
R	0.25	0.50	0.010	0.019

### SOLDERING FOOTPRINT\*

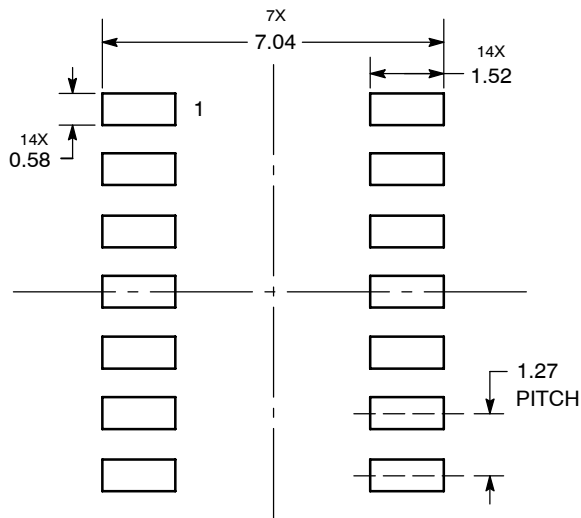

DIMENSIONS: MILLIMETERS

\*For additional information on our Pb-Free strategy and soldering details, please download the ON Semiconductor Soldering and Mounting Techniques Reference Manual, SOLDERRM/D.

# MC14070B, MC14077B

## PACKAGE DIMENSIONS

SOEIAJ-14  
CASE 965-01  
ISSUE A

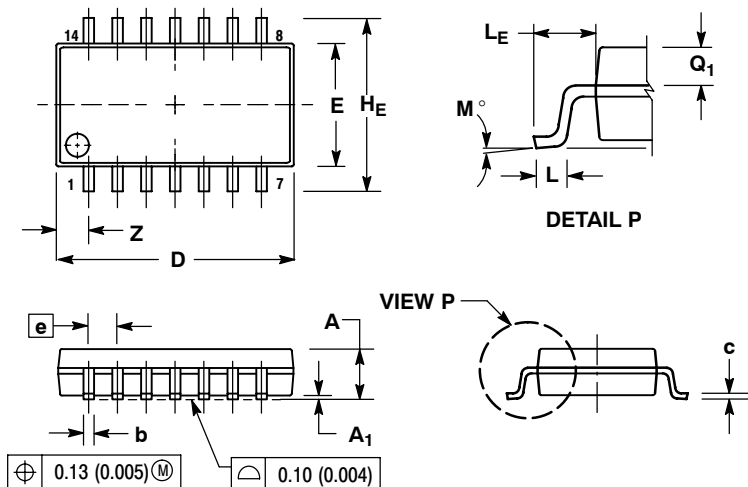

### NOTES:

1. DIMENSIONING AND TOLERANCING PER ANSI Y14.5M, 1982.
2. CONTROLLING DIMENSION: MILLIMETER.
3. DIMENSIONS D AND E DO NOT INCLUDE MOLD FLASH OR PROTRUSIONS AND ARE MEASURED AT THE PARTING LINE. MOLD FLASH OR PROTRUSIONS SHALL NOT EXCEED 0.15 (0.006) PER SIDE.
4. TERMINAL NUMBERS ARE SHOWN FOR REFERENCE ONLY.
5. THE LEAD WIDTH DIMENSION (b) DOES NOT INCLUDE DAMBAR PROTRUSION. ALLOWABLE DAMBAR PROTRUSION SHALL BE 0.08 (0.003) TOTAL IN EXCESS OF THE LEAD WIDTH DIMENSION AT MAXIMUM MATERIAL CONDITION. DAMBAR CANNOT BE LOCATED ON THE LOWER RADIUS OR THE FOOT. MINIMUM SPACE BETWEEN PROTRUSIONS AND ADJACENT LEAD TO BE 0.46 (0.018).

DIM	MILLIMETERS		INCHES	
	MIN	MAX	MIN	MAX
A	---	2.05	---	0.081
A <sub>1</sub>	0.05	0.20	0.002	0.008
b	0.35	0.50	0.014	0.020
c	0.10	0.20	0.004	0.008
D	9.90	10.50	0.390	0.413
E	5.10	5.45	0.201	0.215
e	1.27 BSC		0.050 BSC	
H <sub>E</sub>	7.40	8.20	0.291	0.323
0.50	0.50	0.85	0.020	0.033
L <sub>E</sub>	1.10	1.50	0.043	0.059
M	0°	10°	0°	10°
Q <sub>1</sub>	0.70	0.90	0.028	0.035
Z	---	1.42	---	0.056

ON Semiconductor and are registered trademarks of Semiconductor Components Industries, LLC (SCILLC). SCILLC reserves the right to make changes without further notice to any products herein. SCILLC makes no warranty, representation or guarantee regarding the suitability of its products for any particular purpose, nor does SCILLC assume any liability arising out of the application or use of any product or circuit, and specifically disclaims any and all liability, including without limitation special, consequential or incidental damages. "Typical" parameters which may be provided in SCILLC data sheets and/or specifications can and do vary in different applications and actual performance may vary over time. All operating parameters, including "Typicals" must be validated for each customer application by customer's technical experts. SCILLC does not convey any license under its patent rights nor the rights of others. SCILLC products are not designed, intended, or authorized for use as components in systems intended for surgical implant into the body, or other applications intended to support or sustain life, or for any other application in which the failure of the SCILLC product could create a situation where personal injury or death may occur. Should Buyer purchase or use SCILLC products for any such unintended or unauthorized application, Buyer shall indemnify and hold SCILLC and its officers, employees, subsidiaries, affiliates, and distributors harmless against all claims, costs, damages, and expenses, and reasonable attorney fees arising out of, directly or indirectly, any claim of personal injury or death associated with such unintended or unauthorized use, even if such claim alleges that SCILLC was negligent regarding the design or manufacture of the part. SCILLC is an Equal Opportunity/Affirmative Action Employer. This literature is subject to all applicable copyright laws and is not for resale in any manner.

### PUBLICATION ORDERING INFORMATION

**LITERATURE FULFILLMENT:**  
Literature Distribution Center for ON Semiconductor  
P.O. Box 5163, Denver, Colorado 80217 USA  
**Phone:** 303-675-2175 or 800-344-3860 Toll Free USA/Canada  
**Fax:** 303-675-2176 or 800-344-3867 Toll Free USA/Canada  
**Email:** orderlit@onsemi.com

**N. American Technical Support:** 800-282-9855 Toll Free  
USA/Canada  
**Europe, Middle East and Africa Technical Support:**  
Phone: 421 33 790 2910  
**Japan Customer Focus Center**  
Phone: 81-3-5773-3850

**ON Semiconductor Website:** [www.onsemi.com](http://www.onsemi.com)  
**Order Literature:** <http://www.onsemi.com/orderlit>

For additional information, please contact your local Sales Representative

MC14070B/D