

Features

- Extremely high dv/dt capability
- Low Gate Charge Qg results in Simple Drive Requirement
- 100% avalanche tested
- Gate charge minimized
- Very low intrinsic capacitances
- Very good manufacturing repeatability

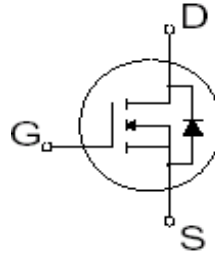

V_{DSS} = 500V

I_D = 5A

R_{DS(ON)} = 1.2 Ω

Description

SSF2715 is a new generation of high voltage N-Channel enhancement mode power MOSFETs and is obtained through an extreme optimization layout design, in addition to pushing on-resistance significantly down, special care is taken to ensure a very good dv/dt capability, provide superior switching performance, withstand high energy pulse in the avalanche, and increases packing density.

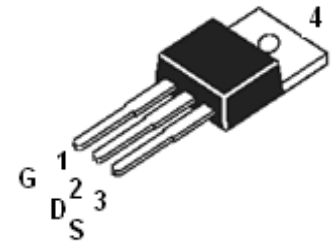

SSF2715 TOP View (TO220)

Application

- High current, high speed switching
- Lighting
- Ideal for off-line power supply, adaptor, PFC

Absolute Maximum Ratings

	Parameter	Max.	Units
I _D @T _C =25 °C	Continuous Drain Current, V _{GS} @10V	5	A
I _D @T _C =100C	Continuous Drain Current, V _{GS} @10V	3	
I _{DM}	Pulsed Drain Current ①	20	
P _D @T _C =25C	Power Dissipation	80	W
	Linear Derating Factor	0.67	W/ °C
V _{GS}	Gate-to-Source Voltage	±30	V
E _{AS}	Single Pulse Avalanche Energy ②	120	mJ
I _{AR}	Avalanche Current ①	5	A
E _{AR}	Repetitive Avalanche Energy ①	8.5	mJ
dv/dt	Peak Diode Recovery dv/dt ③	4.5	V/ns
T _J	Operating Junction and	- 55 to +150	°C
T _{STG}	Storage Temperature Range		

Thermal Resistance

	Parameter	Min.	Typ.	Max.	Units
R _{θJC}	Junction-to-case	—	—	1.56	°C/W
R _{θCS}	Case-to-Sink, Flat, Greased Surface	—	0.50	—	
R _{θJA}	Junction-to-Ambient	—	—	62.5	

Electrical Characteristics @T_J=25 °C(unless otherwise specified)

	Parameter	Min.	Typ.	Max.	Units	Test Conditions
V _{(BR)DSS}	Drain-to-Source Breakdown Voltage	500	—	—	V	V _{GS} =0V, I _D =250μA
ΔV _{(BR)DSS} /ΔT _J	Breakdown Voltage Temp.Coefficient	—	0.6	—	V/C	Reference to 25°C, I _D =250μA
R _{DS(on)}	Static Drain-to-Source On-resistance	—	1.15	1.2	Ω	V _{GS} =10V, I _D =2.5A ④
V _{GS(th)}	Gate Threshold Voltage	2.0	—	4.0	V	V _{DS} =V _{GS} , I _D =250μA
g _{fs}	Forward Transconductance	—	4.3	—	S	V _{DS} =40V, I _D =2.25A
I _{DSS}	Drain-to-Source Leakage current	—	—	1	μ A	V _{DS} =500V, V _{GS} =0V
		—	—	10		V _{DS} =400V, V _{GS} =0V, T _J =150C
I _{GSS}	Gate-to-Source Forward leakage	—	—	100	nA	V _{GS} =30V
	Gate-to-Source Reverse leakage	—	—	-100		V _{GS} =-30V
Q _g	Total Gate Charge	—	11	15	nC	I _D =5A
Q _{gs}	Gate-to-Source charge	—	3	—		V _{DS} =400V
Q _{gd}	Gate-to-Drain("Miller") charge	—	5	—		V _{GS} =10V
t _{d(on)}	Turn-on Delay Time	—	13	36	nS	V _{DD} =250V
t _r	Rise Time	—	22	54		I _D =5A
t _{d(off)}	Turn-Off Delay Time	—	28	66		R _G =25Ω
t _f	Fall Time	—	20	50		
C _{iss}	Input Capacitance	—	515	670	pF	V _{GS} =0V
C _{oss}	Output Capacitance	—	55	72		V _{DS} =25V
C _{rss}	Reverse Transfer Capacitance	—	6.5	8.5		f=1.0MHz

Source-Drain Ratings and Characteristics

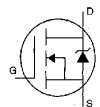
	Parameter	Min.	Typ.	Max.	Units	Test Conditions
I _S	Continuous Source Current (Body Diode)	—	—	5	A	MOSFET symbol showing the integral reverse p-n junction diode. 
I _{SM}	Pulsed Source Current (Body Diode) ①	—	—	20		
V _{SD}	Diode Forward Voltage	—	—	1.4	V	T _J =25°C, I _S =5A, V _{GS} =0V ④
T _{rr}	Reverse Recovery Time	—	300	—	nS	T _J =25°C, I _F =5A
Q _{rr}	Reverse Recovery Charge	—	1.8	—	uC	di/dt=100A/μs ④

Notes:

- ① Repetitive rating; pulse width limited by maximum junction temperature
- ② L = 15mH, I_{AS} = 4 A, V_{DD} = 50V, R_G = 25Ω, Starting T_J = 25°C
- ③ I_{SD} ≤ 5A, di/dt ≤ 200A/μs, V_{DD} ≤ V_{(BR)DSS}, T_J ≤ 25 °C
- ④ Pulse width ≤ 300 μs; duty cycle ≤ 2%

Typical Performance Characteristics

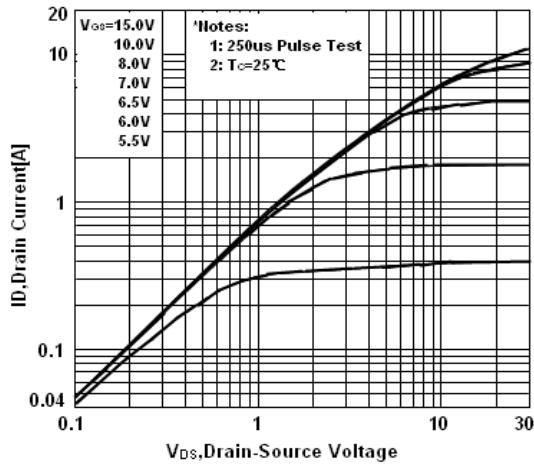

Figure 1 On-Region Characteristics

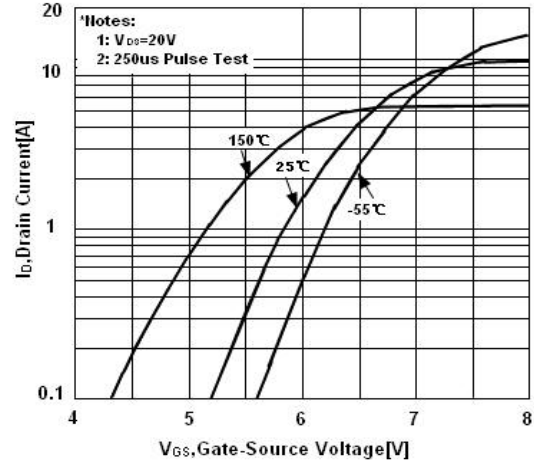

Figure 2 Transfer Characteristics

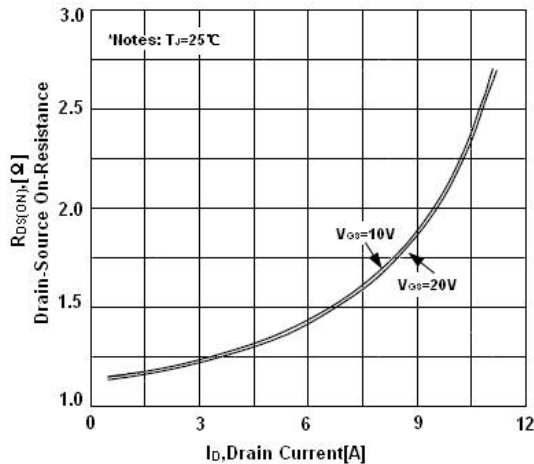

Figure 3 On-Resistance Variation vs. Drain Current and Gate Voltage

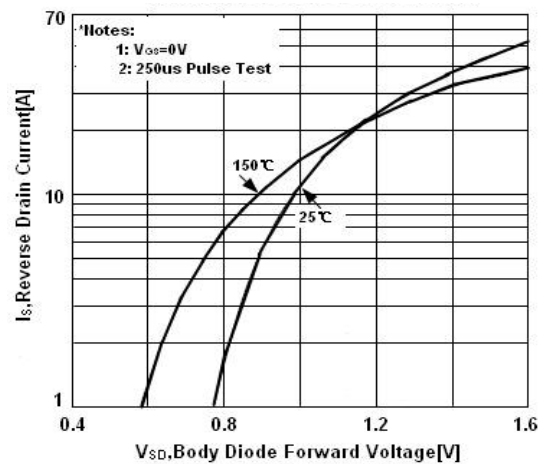

Figure 4 Body diode forward Voltage Variation vs. Source Current and temperature

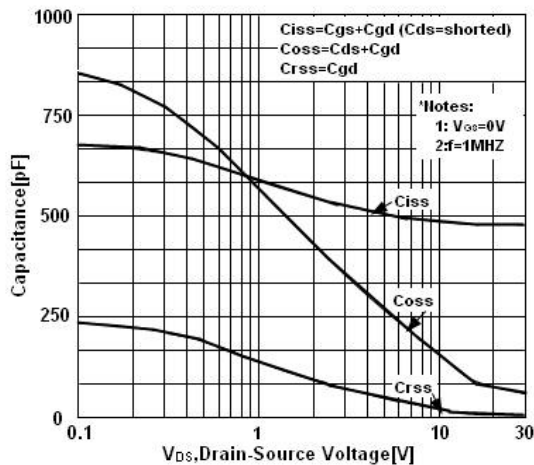

Figure 5 Capacitance Characteristics

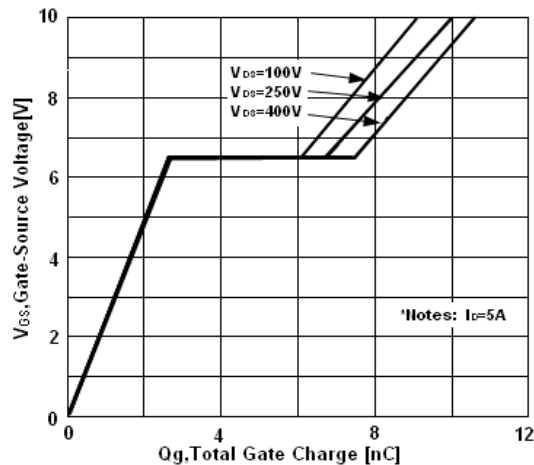

Figure 6 Gate Charge Characteristics

Typical Performance Characteristics

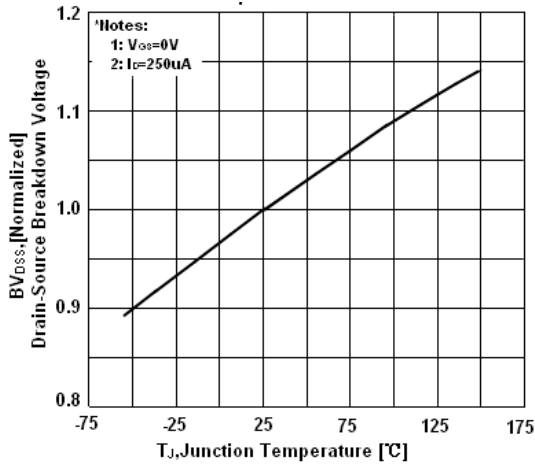

Figure 7 Breakdown Voltage Variation vs. Temperature

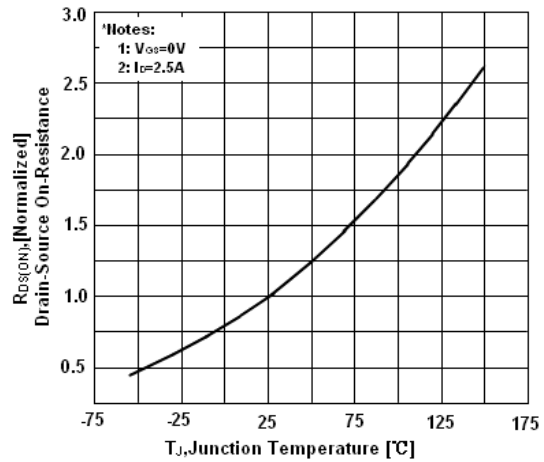

Figure 8 On-Resistance Variation vs. Temperature

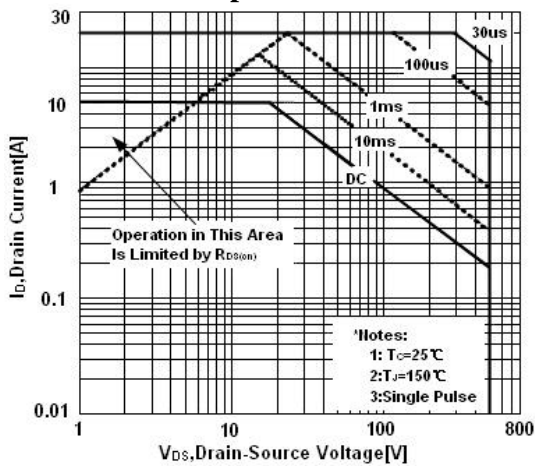

Figure 9 Maximum Safe Operation Area

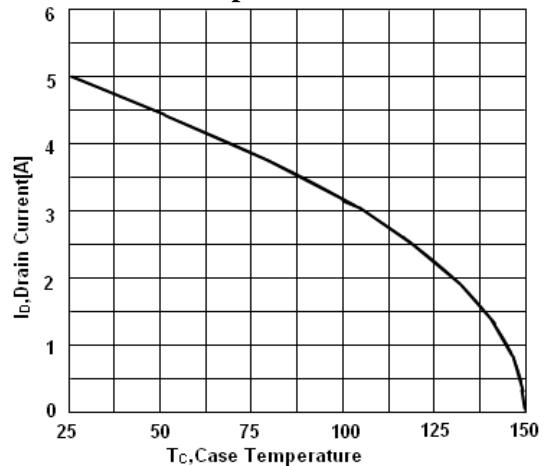

Figure 10 Maximum Drain Current vs. Case Temperature

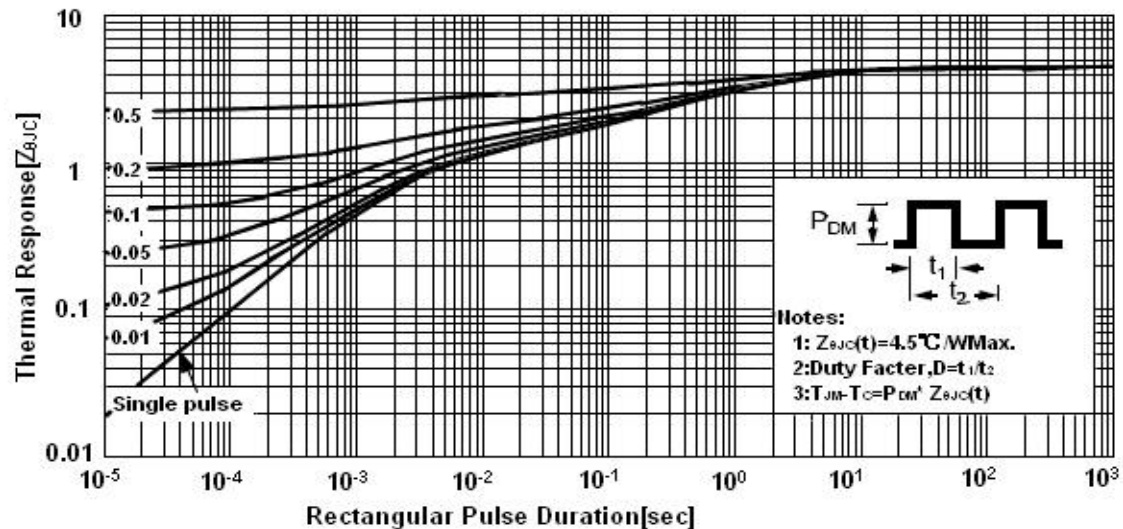
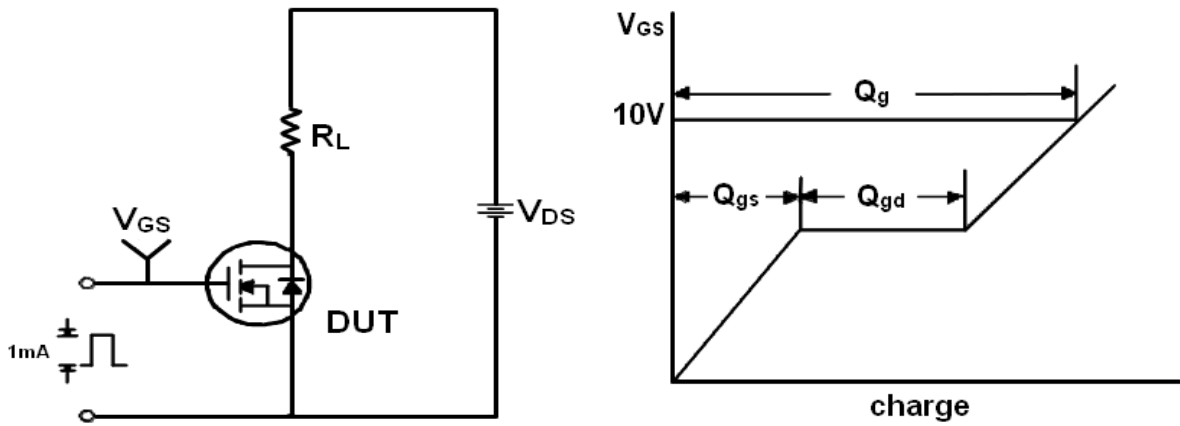
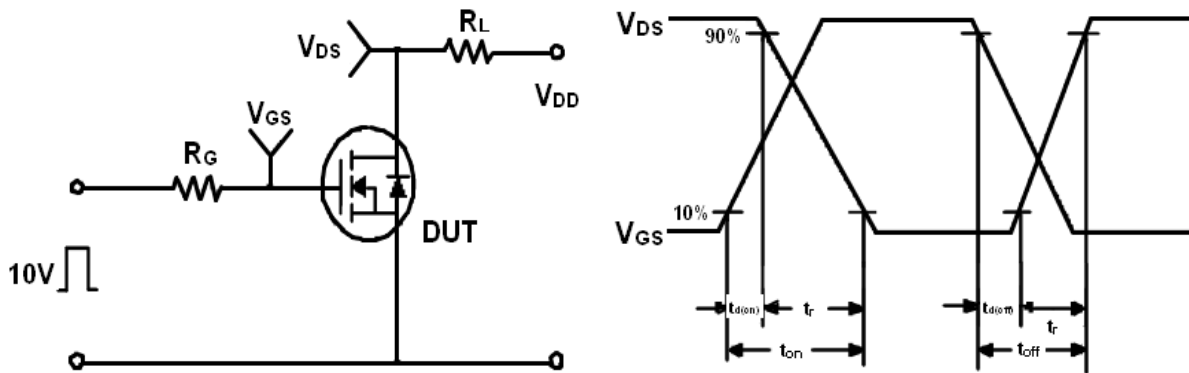

Figure 12 Transient Thermal Response Curve

Test Circuit and Waveform



Gate Charge Test Circuit & Waveform



Resistive Switching Test Circuit & Waveform

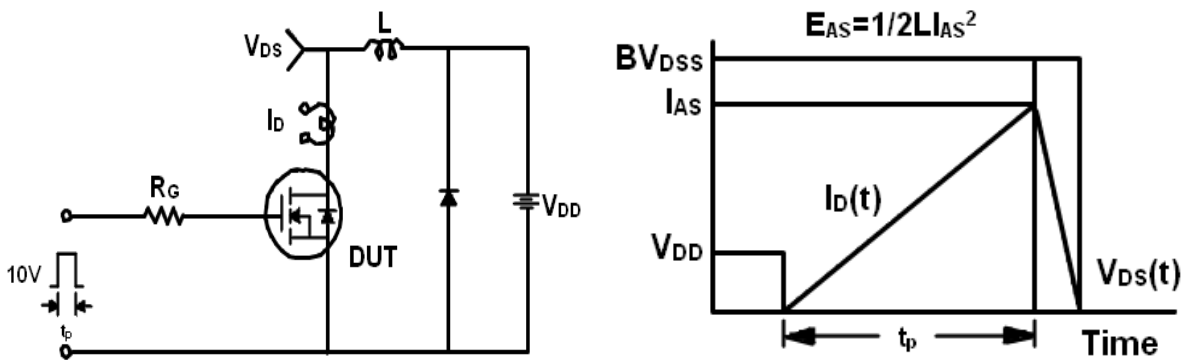

Unclamped Inductive Switching Test Circuit & Waveform

Mechanical Dimensions

TO-220

