

Dimensions (mm)

Recommended Pad Layout

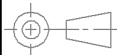
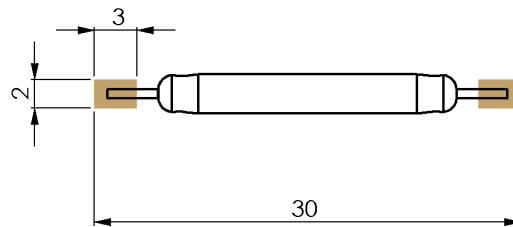
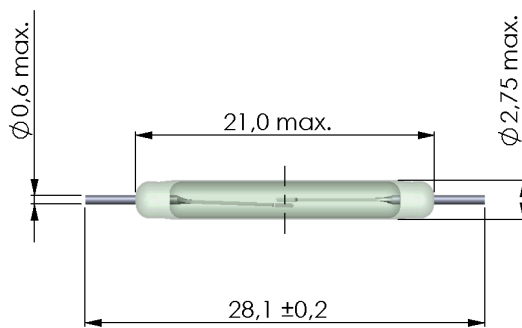

tolerances according to DIN ISO 2768 m

Magnetic properties	Conditions	Min	Typ	Max	Unit
Pull-In excitation (Reference value)	Reed switch unmodified measured in coil- "define operation"	25		30	AT
Test-Coil	Reed switch unmodified	KMS-01			
Pull-In excitation (modified contact)	Reed switch modified phys. conditioned tolerance of +/- 1 AT	34		47	AT
Test-Coil	Reed switch modified	KMS-01			
Pull-In in milliTesla (modified conta	MS150 - phys. caused tolerance +/- 0,1mT	1,9		2,3	mT

Contact data 52	Conditions	Min	Typ	Max	Unit
Contact-No.		52			
Contact-form		A			
Contact-material		Rhodium			
Contact rating	consider any combination of V & A AC RMS 70 VA			50	W
Switching voltage	DC or Peak AC			350	V
Switching current	DC or Peak AC			0,5	A
Carry current	DC or Peak AC			2,5	A
Contact resistance static	Measured with 40% overdrive Start Value			150	mOhm
Contact resistance dynamic	Maximum value 1,5 ms after excitation Start Value			200	mOhm
Insulation resistance	RH <45 %, 100 V test voltage	10			GOhm
Breakdown voltage (<36 AT)	according to IEC 255-5	500			VDC
Operate time incl. bounce	measured with 40% overdrive			1,1	ms
Release time	measured with no coil excitation			0,1	ms
Capacity	@ 10 kHz across open switch		0,5		pF

Modified dimensions	Conditions	Min	Typ	Max	Unit
Remarks		to dimensions see drawing			

Environmental data	Conditions	Min	Typ	Max	Unit
Shock	1/2 sine wave duration 11ms			50	g
Vibration	from 10 - 2000 Hz			20	g
Operating temperature		-40		130	°C
Storage temperature		-55		130	°C
Soldering temperature	wave soldering max. 5 sec.			260	°C

Modifications in the sense of technical progress are reserved

Designed at: 08.07.09 Designed by: AKELLER
 Last Change at: Last Change by:

Approval at: 09.07.09 Approval by: RKAMP
 Approval at: Approval by:

Version: 01