

IN74HC367A

**Hex 3-State Noninverting Buffer
with Separate 2-Bit and 4-Bit Sections
High-Performance Silicon-Gate CMOS**

The IN74HC367A is identical in pinout to the LS/ALS367. The device inputs are compatible with standard CMOS outputs; with pullup resistors, they are compatible with LS/ALSTTL outputs.

This device is arranged into 2-Bit and 4-Bit sections, each having its own active-low Output Enable. When either of the enables is high, the affected buffer outputs are placed into high-impedance states. The IN74HC367A has noninverting outputs.

- Outputs Directly Interface to CMOS, NMOS, and TTL
- Operating Voltage Range: 2.0 to 6.0 V
- Low Input Current: 1.0 μ A
- High Noise Immunity Characteristic of CMOS Devices

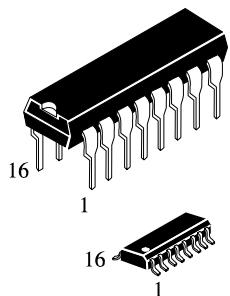

N SUFFIX
PLASTIC

D SUFFIX
SOIC

ORDERING INFORMATION
IN74HC367AN Plastic
IN74HC367AD SOIC
 $T_A = -55^\circ$ to 125° C for all packages

PIN ASSIGNMENT

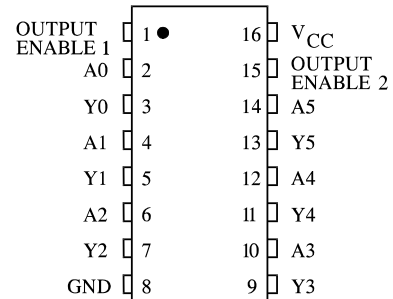

LOGIC DIAGRAM

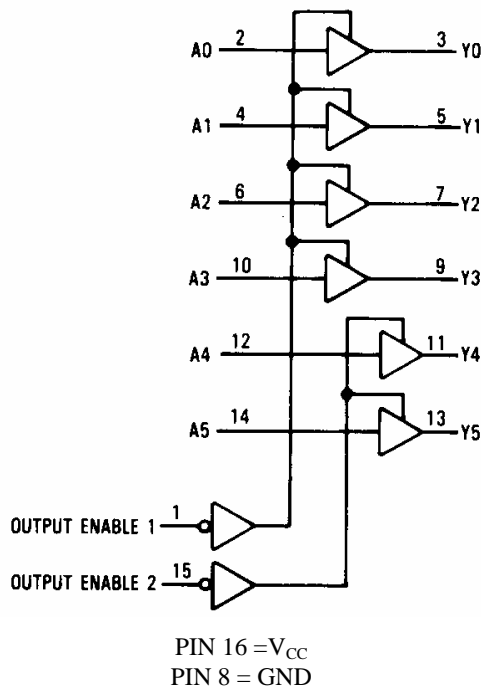

FUNCTION TABLE

Inputs		Output
Enable 1, Enable 2	A	Y
L	L	L
L	H	H
H	X	Z

Z = high impedance
X = don't care

MAXIMUM RATINGS*

Symbol	Parameter	Value	Unit
V_{CC}	DC Supply Voltage (Referenced to GND)	-0.5 to +7.0	V
V_{IN}	DC Input Voltage (Referenced to GND)	-1.5 to $V_{CC} + 1.5$	V
V_{OUT}	DC Output Voltage (Referenced to GND)	-0.5 to $V_{CC} + 0.5$	V
I_{IN}	DC Input Current, per Pin	± 20	mA
I_{OUT}	DC Output Current, per Pin	± 35	mA
I_{CC}	DC Supply Current, V_{CC} and GND Pins	± 75	mA
P_D	Power Dissipation in Still Air, Plastic DIP+ SOIC Package+	750 500	mW
T_{stg}	Storage Temperature	-65 to +150	$^{\circ}C$
T_L	Lead Temperature, 1 mm from Case for 10 Seconds (Plastic DIP or SOIC Package)	260	$^{\circ}C$

*Maximum Ratings are those values beyond which damage to the device may occur. Functional operation should be restricted to the Recommended Operating Conditions.

+Derating - Plastic DIP: - 10 mW/ $^{\circ}C$ from 65 $^{\circ}$ to 125 $^{\circ}C$
SOIC Package: - 7 mW/ $^{\circ}C$ from 65 $^{\circ}$ to 125 $^{\circ}C$

RECOMMENDED OPERATING CONDITIONS

Symbol	Parameter	Min	Max	Unit
V_{CC}	DC Supply Voltage (Referenced to GND)	2.0	6.0	V
V_{IN}, V_{OUT}	DC Input Voltage, Output Voltage (Referenced to GND)	0	V_{CC}	V
T_A	Operating Temperature, All Package Types	-55	+125	$^{\circ}C$
t_r, t_f	Input Rise and Fall Time (Figure 1)			ns
	$V_{CC} = 2.0$ V	0	1000	
	$V_{CC} = 4.5$ V	0	500	
	$V_{CC} = 6.0$ V	0	400	

This device contains protection circuitry to guard against damage due to high static voltages or electric fields. However, precautions must be taken to avoid applications of any voltage higher than maximum rated voltages to this high-impedance circuit. For proper operation, V_{IN} and V_{OUT} should be constrained to the range $GND \leq (V_{IN} \text{ or } V_{OUT}) \leq V_{CC}$.

Unused inputs must always be tied to an appropriate logic voltage level (e.g., either GND or V_{CC}). Unused outputs must be left open.

DC ELECTRICAL CHARACTERISTICS (Voltages Referenced to GND)

Symbol	Parameter	Test Conditions	V _{CC} V	Guaranteed Limit			Unit
				25 °C to -55°C	≤85 °C	≤125 °C	
V _{IH}	Minimum High-Level Input Voltage	V _{OUT} = V _{CC} -0.1 V I _{OUT} ≤ 20 μA	2.0	1.5	1.5	1.5	V
			4.5	3.15	3.15	3.15	
			6.0	4.2	4.2	4.2	
V _{IL}	Maximum Low - Level Input Voltage	V _{OUT} =0.1 V I _{OUT} ≤ 20 μA	2.0	0.3	0.3	0.3	V
			4.5	0.9	0.9	0.9	
			6.0	1.2	1.2	1.2	
V _{OH}	Minimum High-Level Output Voltage	V _{IN} =V _{IH} I _{OUT} ≤ 20 μA	2.0	1.9	1.9	1.9	V
			4.5	4.4	4.4	4.4	
		6.0	5.9	5.9	5.9		
		V _{IN} =V _{IH} I _{OUT} ≤ 6.0 mA I _{OUT} ≤ 7.8 mA	4.5	3.98	3.84	3.7	
6.0	5.48	5.34	5.2				
V _{OL}	Maximum Low-Level Output Voltage	V _{IN} = V _{IL} I _{OUT} ≤ 20 μA	2.0	0.1	0.1	0.1	V
			4.5	0.1	0.1	0.1	
		6.0	0.1	0.1	0.1		
		V _{IN} = V _{IL} I _{OUT} ≤ 6.0 mA I _{OUT} ≤ 7.8 mA	4.5	0.26	0.33	0.4	
6.0	0.26	0.33	0.4				
I _{IN}	Maximum Input Leakage Current	V _{IN} =V _{CC} or GND	6.0	±0.1	±1.0	±1.0	μA
I _{OZ}	Maximum Three-State Leakage Current	Output in High-Impedance State V _{IN} = V _{IL} or V _{IH} V _{OUT} =V _{CC} or GND	6.0	±0.5	±5.0	±10	μA
I _{CC}	Maximum Quiescent Supply Current (per Package)	V _{IN} =V _{CC} or GND I _{OUT} =0μA	6.0	8.0	80	160	μA

AC ELECTRICAL CHARACTERISTICS (C_L=50pF, Input t_r=t_f=6.0 ns)

Symbol	Parameter	V _{CC} V	Guaranteed Limit			Unit
			25 °C to -55°C	≤85°C	≤125°C	
t _{PLH} , t _{PHL}	Maximum Propagation Delay, Input A to Output Y (Figures 1 and 3)	2.0 4.5 6.0	120 24 20	150 30 26	180 36 31	ns
t _{PLZ} , t _{PHZ}	Maximum Propagation Delay ,Output Enable to Output Y (Figures 2 and 4)	2.0 4.5 6.0	175 35 30	220 44 37	265 53 46	ns
t _{PZL} , t _{PZH}	Maximum Propagation Delay ,Output Enable to Output Y (Figures 2 and 4)	2.0 4.5 6.0	190 38 32	240 48 41	285 57 48	ns
t _{TLH} , t _{THL}	Maximum Output Transition Time, Any Output (Figures 1 and 3)	2.0 4.5 6.0	60 12 10	75 15 13	90 18 15	ns
C _{IN}	Maximum Input Capacitance	-	10	10	10	pF
C _{OUT}	Maximum Three-State Output Capacitance (Output in High-Impedance State)	-	15	15	15	pF

C _{PD}	Power Dissipation Capacitance (Per Buffer)	Typical @25°C, V _{CC} =5.0 V			pF
	Used to determine the no-load dynamic power consumption: P _D =C _{PD} V _{CC} ² f+I _{CC} V _{CC}	40			

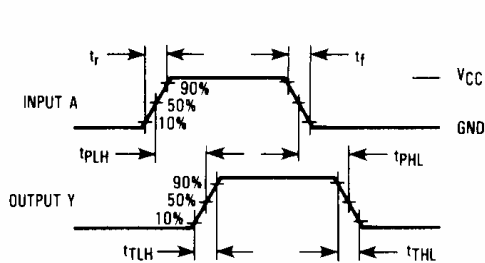

Figure 1. Switching Waveforms

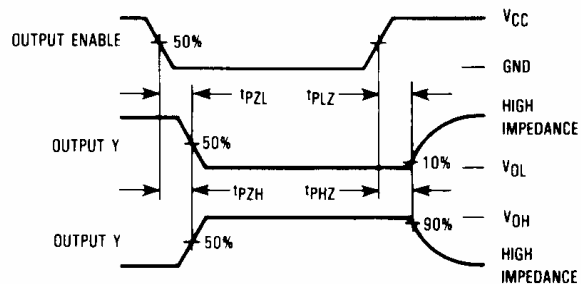
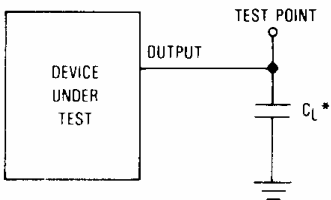
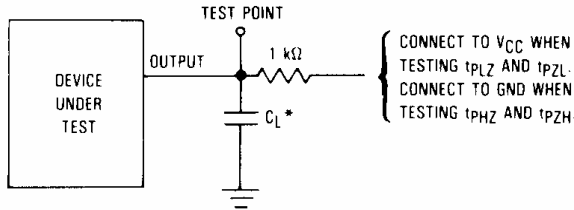

Figure 2. Switching Waveforms



*Includes all probe and jig capacitance.

Figure 3. Test Circuit



*Includes all probe and jig capacitance.

Figure 4. Test Circuit

EXPANDED LOGIC DIAGRAM
(1/6 of the Device)

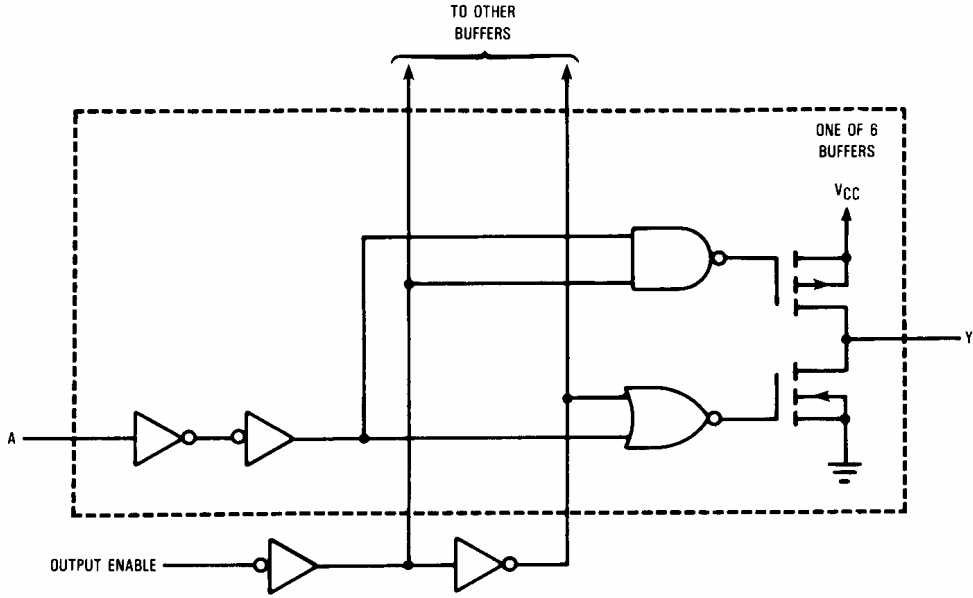

**N SUFFIX PLASTIC DIP
(MS - 001BB)**

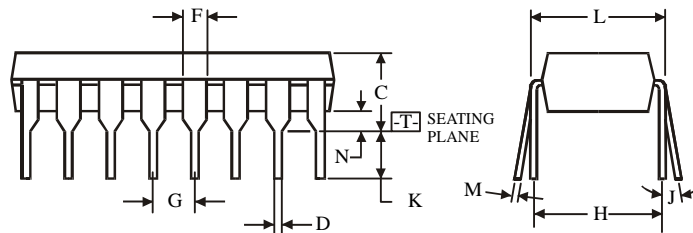
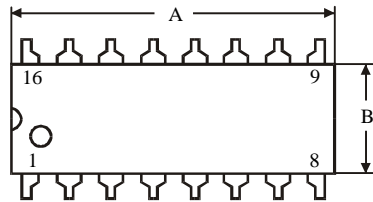
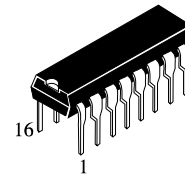

$\oplus 0.25 (0.010) \text{ (M) T}$

NOTES:

- Dimensions "A", "B" do not include mold flash or protrusions.
Maximum mold flash or protrusions 0.25 mm (0.010) per side.

Symbol	Dimension, mm	
	MIN	MAX
A	18.67	19.69
B	6.1	7.11
C		5.33
D	0.36	0.56
F	1.14	1.78
G	2.54	
H	7.62	
J	0°	10°
K	2.92	3.81
L	7.62	8.26
M	0.2	0.36
N	0.38	

**D SUFFIX SOIC
(MS - 012AC)**

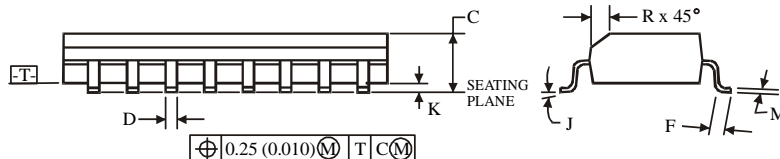
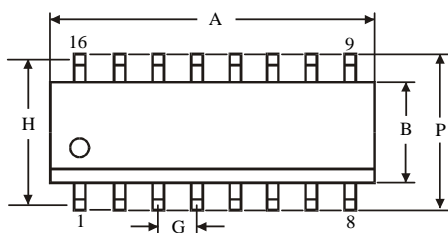
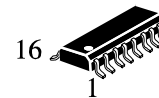

$\oplus 0.25 (0.010) \text{ (M) T C (M)}$

NOTES:

- Dimensions A and B do not include mold flash or protrusion.
- Maximum mold flash or protrusion 0.15 mm (0.006) per side for A; for B - 0.25 mm (0.010) per side.

Symbol	Dimension, mm	
	MIN	MAX
A	9.8	10
B	3.8	4
C	1.35	1.75
D	0.33	0.51
F	0.4	1.27
G	1.27	
H	5.72	
J	0°	8°
K	0.1	0.25
M	0.19	0.25
P	5.8	6.2
R	0.25	0.5