

IN74HC273A

**Octal D Flip-Flop with
Common Clock and Reset
High-Performance Silicon-Gate CMOS**

The IN74HC273A is identical in pinout to the LS/ALS273. The device inputs are compatible with standard CMOS outputs; with pullup resistors, they are compatible with LS/ALSTTL outputs.

This device consists of eight D flip-flops with common Clock and Reset inputs. Each flip-flop is loaded with a low-to-high transition of the Clock input. Reset is asynchronous and active low.

- Outputs Directly Interface to CMOS, NMOS, and TTL
- Operating Voltage Range: 2.0 to 6.0 V
- Low Input Current: 1.0 μ A
- High Noise Immunity Characteristic of CMOS Devices

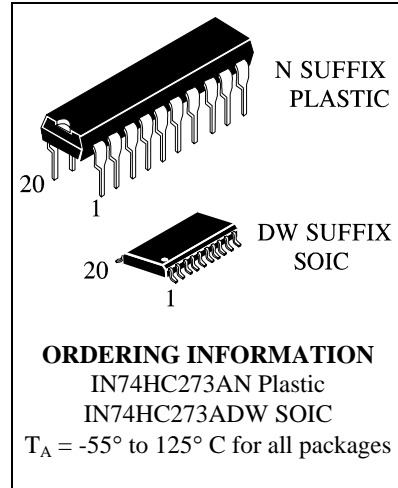

LOGIC DIAGRAM

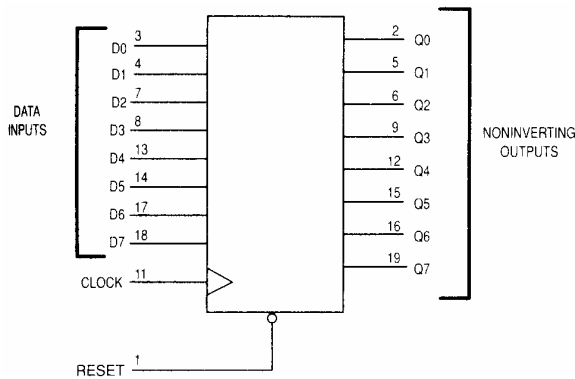

PIN 20 = V_{CC}
PIN 10 = GND

PIN ASSIGNMENT

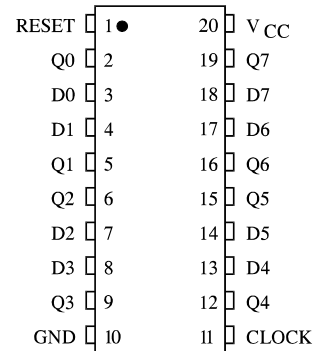

FUNCTION TABLE

Inputs			Output
Reset	Clock	D	Q
L	X	X	L
H		H	H
H		L	L
H	L	X	no change
H		X	no change

X = don't care

MAXIMUM RATINGS*

Symbol	Parameter	Value	Unit
V _{CC}	DC Supply Voltage (Referenced to GND)	-0.5 to +7.0	V
V _{IN}	DC Input Voltage (Referenced to GND)	-1.5 to V _{CC} +1.5	V
V _{OUT}	DC Output Voltage (Referenced to GND)	-0.5 to V _{CC} +0.5	V
I _{IN}	DC Input Current, per Pin	±20	mA
I _{OUT}	DC Output Current, per Pin	±35	mA
I _{CC}	DC Supply Current, V _{CC} and GND Pins	±75	mA
P _D	Power Dissipation in Still Air, Plastic DIP+ SOIC Package+	750 500	mW
T _{stg}	Storage Temperature	-65 to +150	°C
T _L	Lead Temperature, 1 mm from Case for 10 Seconds (Plastic DIP or SOIC Package)	260	°C

*Maximum Ratings are those values beyond which damage to the device may occur. Functional operation should be restricted to the Recommended Operating Conditions.

+Derating - Plastic DIP: - 10 mW/°C from 65° to 125°C
SOIC Package: - 7 mW/°C from 65° to 125°C

RECOMMENDED OPERATING CONDITIONS

Symbol	Parameter	Min	Max	Unit
V _{CC}	DC Supply Voltage (Referenced to GND)	2.0	6.0	V
V _{IN} , V _{OUT}	DC Input Voltage, Output Voltage (Referenced to GND)	0	V _{CC}	V
T _A	Operating Temperature, All Package Types	-55	+125	°C
t _r , t _f	Input Rise and Fall Time (Figure 1)			
	V _{CC} =2.0 V	0	1000	ns
	V _{CC} =4.5 V	0	500	
	V _{CC} =6.0 V	0	400	

This device contains protection circuitry to guard against damage due to high static voltages or electric fields. However, precautions must be taken to avoid applications of any voltage higher than maximum rated voltages to this high-impedance circuit. For proper operation, V_{IN} and V_{OUT} should be constrained to the range GND≤(V_{IN} or V_{OUT})≤V_{CC}.

Unused inputs must always be tied to an appropriate logic voltage level (e.g., either GND or V_{CC}). Unused outputs must be left open.

DC ELECTRICAL CHARACTERISTICS (Voltages Referenced to GND)

Symbol	Parameter	Test Conditions	V _{CC} V	Guaranteed Limit			Unit
				25 °C to -55°C	≤85 °C	≤12 5 °C	
V _{IH}	Minimum High-Level Input Voltage	V _{OUT} =0.1 V or V _{CC} -0.1 V I _{OUT} ≤ 20 μA	2.0	1.5	1.5	1.5	V
			4.5	3.15	3.15	3.15	
			6.0	4.2	4.2	4.2	
V _{IL}	Maximum Low - Level Input Voltage	V _{OUT} =0.1 V or V _{CC} -0.1 V I _{OUT} ≤ 20 μA	2.0	0.5	0.5	0.5	V
			4.5	1.35	1.35	1.35	
			6.0	1.8	1.8	1.8	
V _{OH}	Minimum High-Level Output Voltage	V _{IN} =V _{IH} or V _{IL} I _{OUT} ≤ 20 μA	2.0	1.9	1.9	1.9	V
			4.5	4.4	4.4	4.4	
		6.0	5.9	5.9	5.9		
		V _{IN} =V _{IH} or V _{IL} I _{OUT} ≤ 4.0 mA I _{OUT} ≤ 5.2 mA	4.5	3.98	3.84	3.7	
6.0	5.48	5.34	5.2				
V _{OL}	Maximum Low-Level Output Voltage	V _{IN} = V _{IL} or V _{IH} I _{OUT} ≤ 20 μA	2.0	0.1	0.1	0.1	V
			4.5	0.1	0.1	0.1	
		6.0	0.1	0.1	0.1		
		V _{IN} = V _{IL} or V _{IH} I _{OUT} ≤ 4.0 mA I _{OUT} ≤ 5.2 mA	4.5	0.26	0.33	0.4	
6.0	0.26	0.33	0.4				
I _{IN}	Maximum Input Leakage Current	V _{IN} =V _{CC} or GND	6.0	±0.1	±1.0	±1.0	μA
I _{CC}	Maximum Quiescent Supply Current (per Package)	V _{IN} =V _{CC} or GND I _{OUT} =0μA	6.0	4.0	40	160	μA

AC ELECTRICAL CHARACTERISTICS ($C_L=50\text{pF}$, Input $t_r=t_f=6.0\text{ ns}$)

Symbol	Parameter	V_{CC} V	Guaranteed Limit			Unit
			25 °C to -55°C	≤85°C	≤125°C	
f_{max}	Maximum Clock Frequency (50% Duty Cycle) (Figures 1 and 4)	2.0	6.0	5.0	4.0	MHz
		4.5	30	24	20	
		6.0	35	28	24	
t_{PLH}, t_{PHL}	Maximum Propagation Delay, Clock to Q (Figures 1 and 4)	2.0	145	180	220	ns
		4.5	29	36	44	
		6.0	25	31	38	
t_{PHL}	Maximum Propagation Delay , Reset to Q (Figures 2 and 4)	2.0	145	180	220	ns
		4.5	29	36	44	
		6.0	25	31	38	
t_{TLH}, t_{THL}	Maximum Output Transition Time, Any Output (Figures 1 and 4)	2.0	75	95	110	ns
		4.5	15	19	22	
		6.0	13	16	19	
C_{IN}	Maximum Input Capacitance	-	10	10	10	pF

C_{PD}	Power Dissipation Capacitance (Per Enabled Output)	Typical @25°C, $V_{CC}=5.0\text{ V}$			pF
	Used to determine the no-load dynamic power consumption: $P_D=C_{PD}V_{CC}^2f+I_{CC}V_{CC}$	48			

TIMING REQUIREMENTS ($C_L=50\text{pF}$, Input $t_r=t_f=6.0\text{ ns}$)

Symbol	Parameter	V_{CC} V	Guaranteed Limit			Unit
			25 °C to -55°C	≤85°C	≤125°C	
t_{SU}	Minimum Setup Time, Data to Clock (Figure 3)	2.0	60	75	90	ns
		4.5	12	15	18	
		6.0	10	13	15	
t_h	Minimum Hold Time, Clock to Data (Figure 3)	2.0	3.0	3.0	3.0	ns
		4.5	3.0	3.0	3.0	
		6.0	3.0	3.0	3.0	
t_{rec}	Minimum Recovery Time, Reset Inactive to Clock (Figure 2)	2.0	5.0	5.0	5.0	ns
		4.5	5.0	5.0	5.0	
		6.0	5.0	5.0	5.0	
t_w	Minimum Pulse Width, Clock (Figure 1)	2.0	60	75	90	ns
		4.5	12	15	18	
		6.0	10	13	15	
t_w	Minimum Pulse Width, Reset (Figure 2)	2.0	60	75	90	ns
		4.5	12	15	18	
		6.0	10	13	15	
t_r, t_f	Maximum Input Rise and Fall Times (Figure 1)	2.0	1000	1000	1000	ns
		4.5	500	500	500	
		6.0	400	400	400	

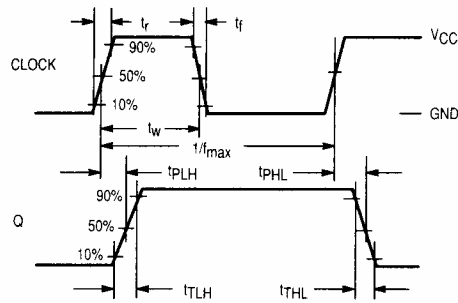

Figure 1. Switching Waveforms

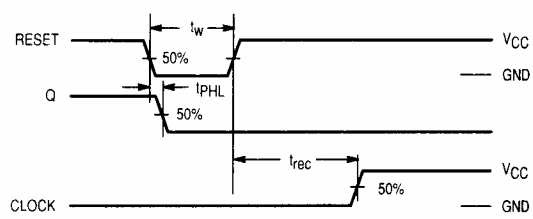

Figure 2. Switching Waveforms

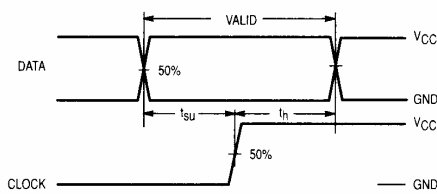

Figure 3. Switching Waveforms

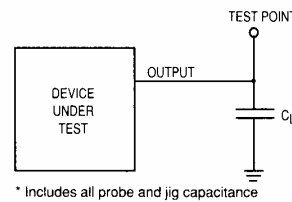
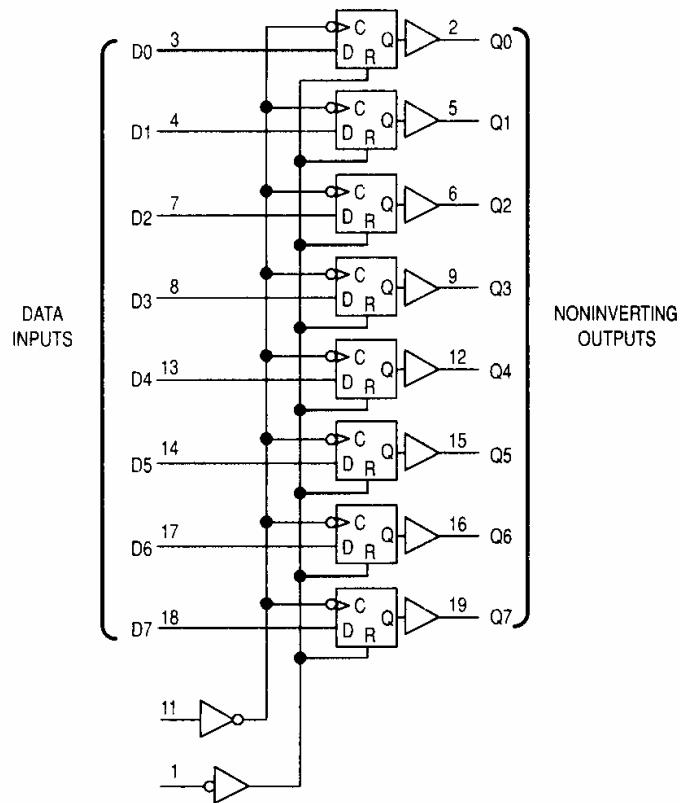
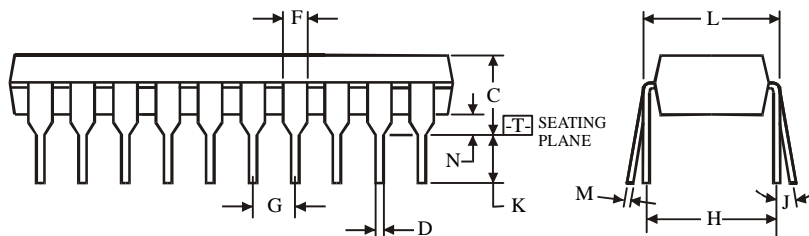
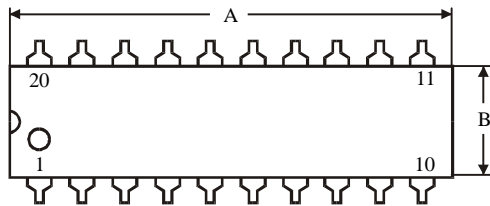
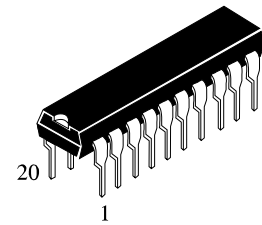

Figure 4. Test Circuit

EXPANDED LOGIC DIAGRAM



**N SUFFIX PLASTIC DIP
(MS - 001AD)**



$\oplus 0.25 (0.010) \text{ (M) T}$

NOTES:

- Dimensions "A", "B" do not include mold flash or protrusions.
Maximum mold flash or protrusions 0.25 mm (0.010) per side.

Symbol	Dimension, mm	
	MIN	MAX
A	24.89	26.92
B	6.1	7.11
C		5.33
D	0.36	0.56
F	1.14	1.78
G	2.54	
H	7.62	
J	0°	10°
K	2.92	3.81
L	7.62	8.26
M	0.2	0.36
N	0.38	

**D SUFFIX SOIC
(MS - 013AC)**

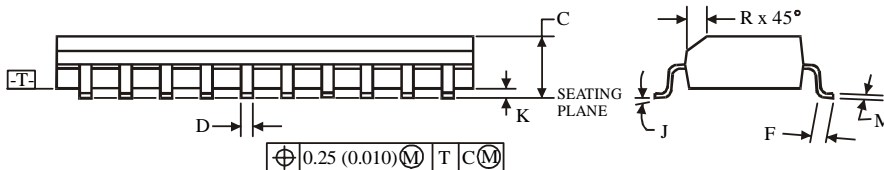
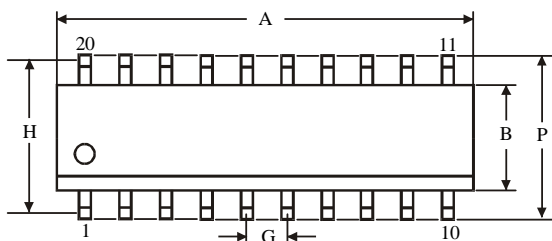
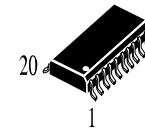

$\oplus 0.25 (0.010) \text{ (M) T C (M)}$

NOTES:

- Dimensions A and B do not include mold flash or protrusion.
- Maximum mold flash or protrusion 0.15 mm (0.006) per side for A; for B - 0.25 mm (0.010) per side.

Symbol	Dimension, mm	
	MIN	MAX
A	12.6	13
B	7.4	7.6
C	2.35	2.65
D	0.33	0.51
F	0.4	1.27
G	1.27	
H	9.53	
J	0°	8°
K	0.1	0.3
M	0.23	0.32
P	10	10.65
R	0.25	0.75