

NB100LVEP224

2.5V/3.3V 1:24 Differential ECL/PECL Clock Driver with Clock Select and Output Enable



ON Semiconductor®

<http://onsemi.com>

Description

The NB100LVEP224 is a low skew 1-to-24 differential clock driver, designed with clock distribution in mind, accepting two clock sources into an input multiplexer. The part is designed for use in low voltage applications which require a large number of outputs to drive precisely aligned low skew signals to their destination. The two clock inputs are differential ECL/PECL and they are selected by the CLK_SEL pin. To avoid generation of a runt clock pulse when the device is enabled/disabled, the Output Enable (\overline{OE}) is synchronous ensuring the outputs will only be enabled/disabled when they are already in LOW state (See Figure 4).

The NB100LVEP224 guarantees low output-to-output skew. The optimal design, layout, and processing minimize skew within a device and from lot to lot. In any differential output, the same bias and termination scheme is required. Unused output pairs should be left unterminated (open) to “reduce power and switching noise as much as possible.” Any unused single line of a differential pair should be terminated the same as the used line to maintain balanced loads on the differential driver outputs. The wide VIHCMR specification allows both pair of CLOCK inputs to accept LVDS levels.

The NB100LVEP224, as with most other ECL devices, can be operated from a positive V_{CC} supply in LVPECL mode. This allows the LVEP224 to be used for high performance clock distribution in +3.3 V or +2.5 V systems. Single-ended CLK input operation is limited to a $V_{CC} \geq 3.0$ V in LVPECL mode, or $V_{EE} \leq -3.0$ V in NECL mode. In a PECL environment, series or Thevenin line terminations are typically used as they require no additional power supplies. For more information on PECL terminations, designers should refer to Application Note AND8020/D.

Features

- 20 ps Typical Output-to-Output Skew
- 75 ps Typical Device-to-Device Skew
- Maximum Frequency > 1 GHz
- 650 ps Typical Propagation Delay
- LVPECL Mode Operating Range:
 $V_{CC} = 2.375$ V to 3.8 V with $V_{EE} = 0$ V
- NECL Mode Operating Range:
 $V_{CC} = 0$ V with $V_{EE} = -2.375$ V to -3.8 V
- Internal Input Pulldown Resistors
- Q Output will Default Low with Inputs Open or at V_{EE}
- Thermally Enhanced 64-Lead LQFP
- CLOCK Inputs are LVDS-Compatible; Requires External 100 Ω LVDS Termination Resistor
- Pb-Free Packages are Available*

*For additional information on our Pb-Free strategy and soldering details, please download the ON Semiconductor Soldering and Mounting Techniques Reference Manual, SOLDERRM/D.

MARKING DIAGRAM*

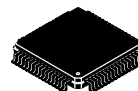

LQFP-64
FA SUFFIX
CASE 848G

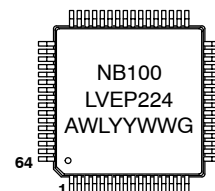

A = Assembly Location
WL = Wafer Lot
YY = Year
WW = Work Week
G = Pb-Free Package

*For additional marking information, refer to Application Note AND8002/D.

ORDERING INFORMATION

See detailed ordering and shipping information in the package dimensions section on page 8 of this data sheet.

NB100LVEP224

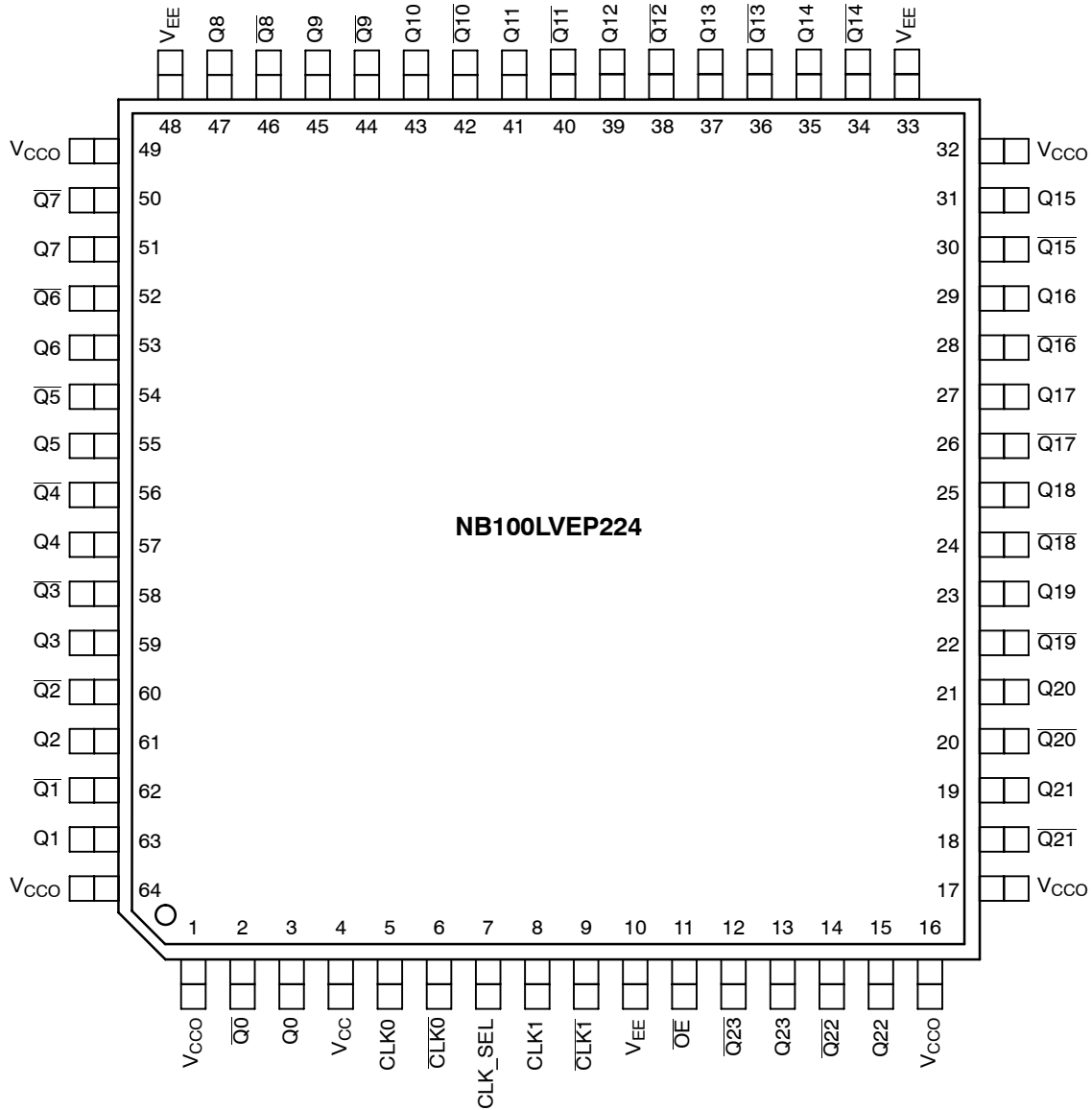

All V_{CC}, V_{CC0}, and V_{EE} pins must be externally connected to appropriate Power Supply to guarantee proper operation. The thermally conductive exposed pad on package bottom (see package case drawing) must be attached to a heat-sinking conduit, capable of transferring 1.2 Watts. This exposed pad is electrically connected to V_{EE} internally.

Figure 1. 64-Lead LQFP Pinout (Top View)

Table 1. PIN DESCRIPTION

PIN	FUNCTION
CLK0*, CLK0**	ECL Differential Input Clock
CLK1*, CLK1**	ECL Differential Input Clock
CLK_SEL*	ECL Input CLK Select
OE*	ECL Output Enable
Q0–Q23, Q0–Q23	ECL Differential Outputs
V _{CC} , V _{CC0}	Positive Supply
V _{EE} ***	Negative Supply

* Pins will default LOW when left open.

** Pins will default HIGH when left open.

***The thermally conductive exposed pad on the bottom of the package is electrically connected to V_{EE} internally.

Table 2. FUNCTION TABLE

OE (1)	CLK_SEL	Q0–Q23	Q0–Q23
L	L	CLK0	CLK0
L	H	CLK1	CLK1
H	L	L	H
H	H	L	H

1. The OE (Output Enable) signal is synchronized with the falling edge of the LVPECL_CLK signal.

NB100LVEP224

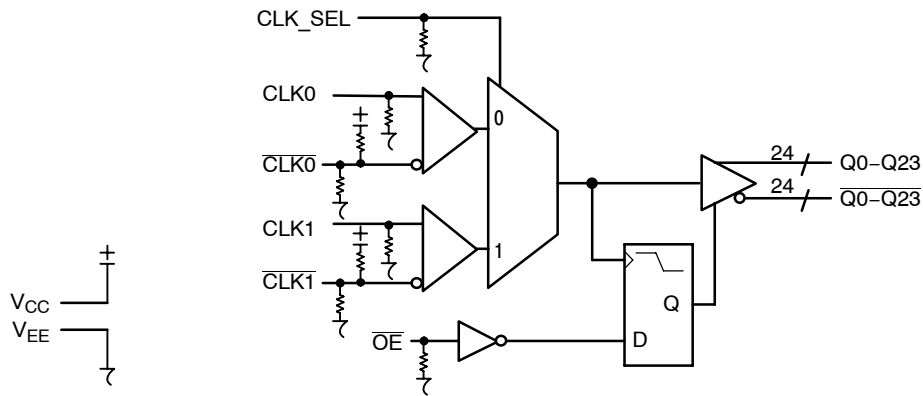

Figure 2. Logic Diagram

Table 3. ATTRIBUTES

Characteristics		Value	
Internal Input Pulldown Resistor		75 kΩ	
Internal Input Pullup Resistor		37.5 kΩ	
ESD Protection	Human Body Model	> 2 kV	
	Machine Model	> 150 V	
	Charged Device Model	> 2 kV	
Moisture Sensitivity, Indefinite Time Out of Drypack (Note 2)	Pb Pkg	Level 2	
	LQFP-64	Level 2	Level 3
Flammability Rating	Oxygen Index: 28 to 34	UL 94 V-0 @ 0.125 in	
Transistor Count		654 Devices	
Meets or exceeds JEDEC Spec EIA/JESD78 IC Latchup Test			

2. For additional information, refer to Application Note AND8003/D.

Table 4. MAXIMUM RATINGS

Symbol	Parameter	Condition 1	Condition 2	Rating	Unit
V _{CC}	PECL Mode Power Supply	V _{EE} = 0 V		6	V
V _{EE}	NECL Mode Power Supply	V _{CC} = 0 V		-6	V
V _I	PECL Mode Input Voltage NECL Mode Input Voltage	V _{EE} = 0 V V _{CC} = 0 V	V _I ≤ V _{CC} V _I ≥ V _{EE}	6 to 0 -6 to 0	V
T _A	Operating Temperature Range			-40 to +85	°C
T _{stg}	Storage Temperature Range			-65 to +150	°C
θ _{JA}	Thermal Resistance (Junction-to-Ambient) (See Application Information)	0 lfpm	64 LQFP	35.6	°C/W
		500 lfpm	64 LQFP	30	°C/W
θ _{JC}	Thermal Resistance (Junction-to-Case) (See Application Information)	0 lfpm	64 LQFP	3.2	°C/W
		500 lfpm	64 LQFP	6.4	°C/W
T _{sol}	Wave Solder	Pb		265	°C
		Pb-Free		265	°C

Stresses exceeding Maximum Ratings may damage the device. Maximum Ratings are stress ratings only. Functional operation above the Recommended Operating Conditions is not implied. Extended exposure to stresses above the Recommended Operating Conditions may affect device reliability.

NB100LVEP224

Table 5. LVPECL DC CHARACTERISTICS $V_{CC} = 2.5\text{ V}$; $V_{EE} = 0\text{ V}$ (Note 3)

Symbol	Characteristic	-40°C			25°C			85°C			Unit
		Min	Typ	Max	Min	Typ	Max	Min	Typ	Max	
I_{EE}	Power Supply Current	130	160	195	135	165	200	140	165	205	mA
V_{OH}	Output HIGH Voltage (Note 4)	1355	1480	1605	1355	1480	1605	1355	1480	1605	mV
V_{OL}	Output LOW Voltage (Note 4)	555	680	900	555	680	900	555	680	900	mV
V_{IH}	Input HIGH Voltage (Single-Ended) (Note 5)	1335		1620	1335		1620	1275		1620	mV
V_{IL}	Input LOW Voltage (Single-Ended) (Note 5)	555		900	555		900	555		900	mV
V_{IHCMR}	Input HIGH Voltage Common Mode Range (Differential Configuration) (Note 6) $\text{CLK}/\overline{\text{CLK}}$	1.2		2.5	1.2		2.5	1.2		2.5	V
I_{IH}	Input HIGH Current			150			150			150	μA
I_{IL}	Input LOW Current $\text{CLK}/\overline{\text{CLK}}$	0.5 -150			0.5 -150			0.5 -150			μA

NOTE: Device will meet the specifications after thermal equilibrium has been established when mounted in a test socket or printed circuit board with maintained transverse airflow greater than 500 lfpm. Electrical parameters are guaranteed only over the declared operating temperature range. Functional operation of the device exceeding these conditions is not implied. Device specification limit values are applied individually under normal operating conditions and not valid simultaneously.

- Input and output parameters vary 1:1 with V_{CC} . V_{EE} can vary + 0.125 V to -1.3 V.
- All outputs loaded with 50 Ω to $V_{CC} - 2.0\text{ V}$.
- Do not use V_{BB} at $V_{CC} < 3.0\text{ V}$.
- V_{IHCMR} min varies 1:1 with V_{EE} , V_{IHCMR} max varies 1:1 with V_{CC} . The V_{IHCMR} range is referenced to the most positive side of the differential input signal.

Table 6. LVPECL DC CHARACTERISTICS $V_{CC} = 3.3\text{ V}$; $V_{EE} = 0\text{ V}$ (Note 7)

Symbol	Characteristic	-40°C			25°C			85°C			Unit
		Min	Typ	Max	Min	Typ	Max	Min	Typ	Max	
I_{EE}	Power Supply Current	140	165	195	145	175	205	145	175	210	mA
V_{OH}	Output HIGH Voltage (Note 8)	2155	2280	2405	2155	2280	2405	2155	2280	2405	mV
V_{OL}	Output LOW Voltage (Note 8)	1355	1480	1700	1355	1480	1700	1355	1480	1700	mV
V_{IH}	Input HIGH Voltage (Single-Ended) (Note 9)	2135		2420	2135		2420	2135		2420	mV
V_{IL}	Input LOW Voltage (Single-Ended) (Note 9)	1355		1700	1355		1700	1355		1700	mV
V_{IHCMR}	Input HIGH Voltage Common Mode Range (Differential Configuration) (Note 10) (Figure 5)	1.2		3.3	1.2		3.3	1.2		3.3	V
I_{IH}	Input HIGH Current			150			150			150	μA
I_{IL}	Input LOW Current $\text{CLK}/\overline{\text{CLK}}$	0.5 -150			0.5 -150			0.5 -150			μA

NOTE: Device will meet the specifications after thermal equilibrium has been established when mounted in a test socket or printed circuit board with maintained transverse airflow greater than 500 lfpm. Electrical parameters are guaranteed only over the declared operating temperature range. Functional operation of the device exceeding these conditions is not implied. Device specification limit values are applied individually under normal operating conditions and not valid simultaneously.

- Input and output parameters vary 1:1 with V_{CC} . V_{EE} can vary +0.925 V to -0.5 V.
- All outputs loaded with 50 Ω to $V_{CC} - 2.0\text{ V}$.
- Single ended input operation is limited $V_{CC} \geq 3.0\text{ V}$ in LVPECL mode.
- V_{IHCMR} min varies 1:1 with V_{EE} , V_{IHCMR} max varies 1:1 with V_{CC} . The V_{IHCMR} range is referenced to the most positive side of the differential input signal.

NB100LVEP224

Table 7. NECL DC CHARACTERISTICS $V_{CC} = 0\text{ V}$, $V_{EE} = -2.375\text{ V}$ to -3.8 V (Note 11)

Symbol	Characteristic	-40°C			25°C			85°C			Unit
		Min	Typ	Max	Min	Typ	Max	Min	Typ	Max	
I_{EE}	Power Supply Current $V_{EE} = -2.5\text{ V}$ $V_{EE} = -3.3\text{ V}$	130 140	160 165	195 195	135 145	165 175	200 205	140 145	165 175	205 210	mA
V_{OH}	Output HIGH Voltage (Note 12)	-1145	-1020	-895	-1145	-1020	-895	-1145	-1020	-895	mV
V_{OL}	Output LOW Voltage (Note 12)	-1945	-1820	-1600	-1945	-1820	-1600	-1945	-1820	-1600	mV
V_{IH}	Input HIGH Voltage (Single-Ended) (Note 13)	-1165		-880	-1165		-880	-1165		-880	mV
V_{IL}	Input LOW Voltage (Single-Ended) (Note 13)	-1945		-1600	-1945		-1600	-1945		-1600	mV
V_{IHCMR}	Input HIGH Voltage Common Mode Range (Differential Configuration) (Note 14) (Figure 5)	$V_{EE} + 1.2$		0.0	$V_{EE} + 1.2$		0.0	$V_{EE} + 1.2$		0.0	V
I_{IH}	Input HIGH Current			150			150			150	μA
I_{IL}	Input LOW Current	$\overline{\text{CLK}}$ $\overline{\text{CLK}}$	0.5 -150		0.5 -150			0.5 -150			μA

NOTE: Device will meet the specifications after thermal equilibrium has been established when mounted in a test socket or printed circuit board with maintained transverse airflow greater than 500 lfm. Electrical parameters are guaranteed only over the declared operating temperature range. Functional operation of the device exceeding these conditions is not implied. Device specification limit values are applied individually under normal operating conditions and not valid simultaneously.

11. Input and output parameters vary 1:1 with V_{CC} .

12. All outputs loaded with $50\ \Omega$ to $V_{CC} - 2.0\text{ V}$.

13. Single ended input operation is limited $V_{EE} \leq -3.0\text{ V}$ in NECL mode.

14. V_{IHCMR} min varies 1:1 with V_{EE} . V_{IHCMR} max varies 1:1 with V_{CC} . The V_{IHCMR} range is referenced to the most positive side of the differential input signal.

Table 8. AC CHARACTERISTICS $V_{CC} = 2.375\text{ V}$ to 3.8 V ; $V_{EE} = 0\text{ V}$ (Note 15)

Symbol	Characteristic	-40°C			25°C			85°C			Unit
		Min	Typ	Max	Min	Typ	Max	Min	Typ	Max	
V_{Opp}	Differential Output Voltage (Figure 3) $f_{out} < 50\text{ MHz}$ $f_{out} < 0.8\text{ GHz}$ $f_{out} < 1.0\text{ GHz}$	600 600 600	750 750 700		600 600 525	725 725 650		575 550 400	700 650 525		mV mV mV
t_{PLH} t_{PHL}	Propagation Delay (Differential Configuration) $\text{CLK}_x\text{-Q}_x$ $\text{CLK_SEL}_x\text{-Q}_x$	500 600	600 700	700 800	550 650	650 800	750 900	650 750	750 850	1000 1150	ps ps
t_{skew}	Within-Device Skew (Note 16) Device-to-Device Skew (Note 17)		20 50	40 300		20 50	40 300		35 100	60 300	ps ps
t_{JITTER}	Random Clock Jitter (Figure 3) (RMS)		1	5		1	5		1	5	ps
V_{PP}	Input Swing (Differential Configuration) (Note 19) (Figure 5)	200	800	1200	200	800	1200	200	800	1200	mV
t_S	$\overline{\text{OE}}$ Set Up Time (Note 18)	200			200			200			ps
t_H	$\overline{\text{OE}}$ Hold Time	200			200			200			ps
t_r/t_f	Output Rise/Fall Time (20%–80%)	100	200	300	100	200	300	150	250	350	ps

NOTE: Device will meet the specifications after thermal equilibrium has been established when mounted in a test socket or printed circuit board with maintained transverse airflow greater than 500 lfm. Electrical parameters are guaranteed only over the declared operating temperature range. Functional operation of the device exceeding these conditions is not implied. Device specification limit values are applied individually under normal operating conditions and not valid simultaneously.

15. Measured with PECL 750 mV source, 50% duty cycle clock source. All outputs loaded with $50\ \Omega$ to $V_{CC} - 2\text{ V}$.

16. Skew is measured between outputs under identical transitions and conditions on any one device.

17. Device-to-Device skew for identical transitions at identical V_{CC} levels.

18. $\overline{\text{OE}}$ Set Up Time is defined with respect to the falling edge of the clock. $\overline{\text{OE}}$ High-to-Low transition ensures outputs remain disabled during the next clock cycle. OE Low-to-High transition enables normal operation of the next input clock.

19. V_{PP} is the differential input voltage swing required to maintain AC characteristics including t_{PD} and device-to-device skew.

NB100LVEP224

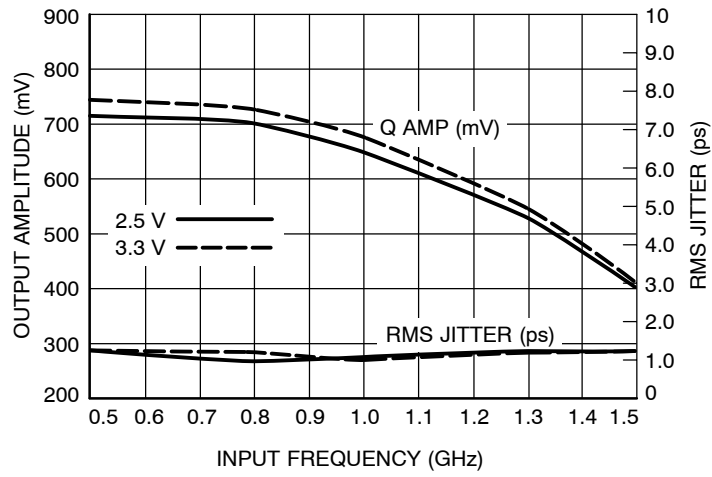

Figure 3. Output Amplitude (V_{OPP}) versus Input Frequency and Random Clock Jitter (t_{JITTER})

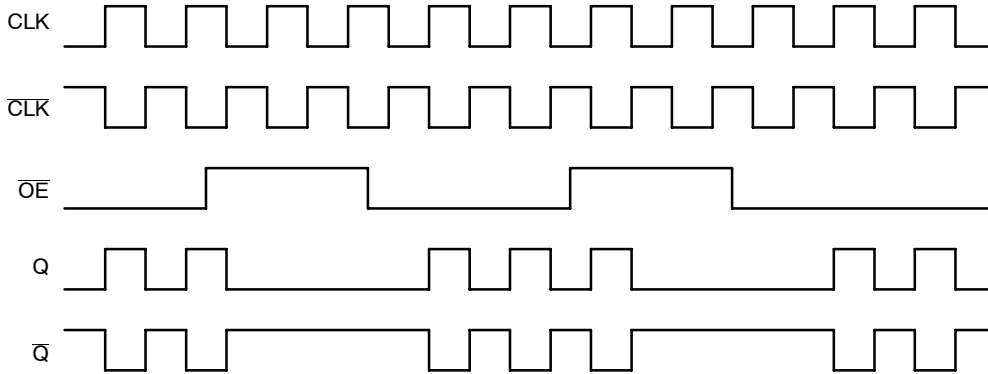

Figure 4. Output Enable (OE) Timing Diagram

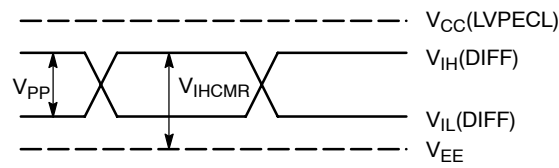

Figure 5. LVPECL Differential Input Levels

APPLICATIONS INFORMATION

Using the thermally enhanced package of the NB100LVEP224

The NB100LVEP224 uses a thermally enhanced 64-lead LQFP package. The package is molded so that a portion of the leadframe is exposed at the surface of the package bottom side. This exposed metal pad will provide the low thermal impedance that supports the power consumption of the NB100LVEP224 high-speed bipolar integrated circuit and will ease the power management task for the system design. In multilayer board designs, a thermal land pattern on the printed circuit board and thermal vias are recommended to maximize both the removal of heat from the package and electrical performance of the NB100LVEP224. The size of the land pattern can be larger, smaller, or even take on a different shape than the exposed pad on the package. However, the solderable area should be at least the same size and shape as the exposed pad on the package. Direct soldering of the exposed pad to the thermal land will provide an efficient thermal conduit. The thermal vias will connect the exposed pad of the package to internal copper planes of the board. The number of vias, spacing, via diameters and land pattern design depend on the application and the amount of heat to be removed from the package.

Maximum thermal and electrical performance is achieved when an array of vias is incorporated in the land pattern.

The recommended thermal land design for NB100LVEP224 applications on multi-layer boards comprises a 4 X 4 thermal via array using a 1.2 mm pitch as shown in Figure 6 providing an efficient heat removal path.

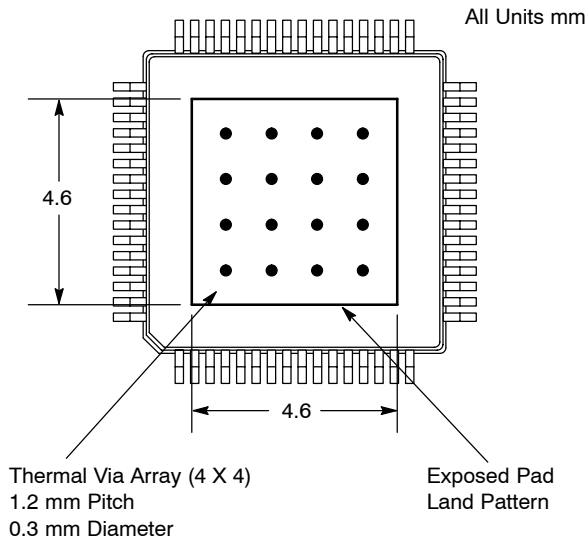

Figure 6. Recommended Thermal Land Pattern

The via diameter should be approximately 0.3 mm with 1 oz. copper via barrel plating. Solder wicking inside the via may result in voiding during the solder process and must be avoided. If the copper plating does not plug the vias, stencil print solder paste onto the printed circuit pad. This will

supply enough solder paste to fill those vias and not starve the solder joints. The attachment process for the exposed pad package is equivalent to standard surface mount packages. Figure 7, "Recommended solder mask openings", shows a recommended solder mask opening with respect to a 4 X 4 thermal via array. Because a large solder mask opening may result in a poor rework release, the opening should be subdivided as shown in Figure 7. For the nominal package standoff of 0.1 mm, a stencil thickness of 5 to 8 mils should be considered.

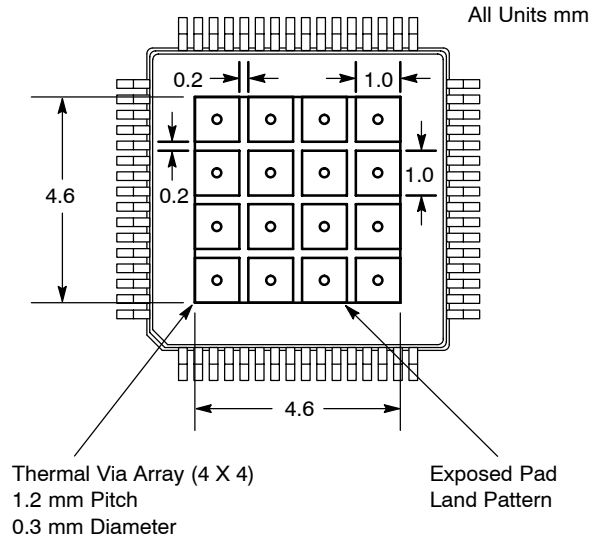

Figure 7. Recommended Solder Mask Openings

Proper thermal management is critical for reliable system operation. This is especially true for high-fanout and high output drive capability products.

For thermal system analysis and junction temperature calculation the thermal resistance parameters of the package is provided:

Table 9. Thermal Resistance *

lfpm	θ_{JA} °C/W	θ_{JC} °C/W
0	35.6	3.2
100	32.8	4.9
500	30.0	6.4

* Junction to ambient and Junction to board, four-conductor layer test board (2S2P) per JESD 51-8

These recommendations are to be used as a guideline, only. It is therefore recommended that users employ sufficient thermal modeling analysis to assist in applying the general recommendations to their particular application to assure adequate thermal performance. The exposed pad of the NB100LVEP224 package is electrically shorted to the substrate of the integrated circuit and V_{EE} . The thermal land should be electrically connected to V_{EE} .

NB100LVEP224

ORDERING INFORMATION

Device	Package	Shipping†
NB100LVEP224FA	LQFP-64	160 Units / Tray
NB100LVEP224FAG	LQFP-64 (Pb-Free)	160 Units / Tray
NB100LVEP224FAR2	LQFP-64	1500 / Tape & Reel
NB100LVEP224FARG	LQFP-64 (Pb-Free)	1500 / Tape & Reel

†For information on tape and reel specifications, including part orientation and tape sizes, please refer to our Tape and Reel Packaging Specifications Brochure, BRD8011/D.

Resource Reference of Application Notes

- AN1405/D** - ECL Clock Distribution Techniques
- AN1406/D** - Designing with PECL (ECL at +5.0 V)
- AN1503/D** - ECLinPS™ I/O SPICE Modeling Kit
- AN1504/D** - Metastability and the ECLinPS Family
- AN1568/D** - Interfacing Between LVDS and ECL
- AN1672/D** - The ECL Translator Guide
- AND8001/D** - Odd Number Counters Design
- AND8002/D** - Marking and Date Codes
- AND8020/D** - Termination of ECL Logic Devices
- AND8066/D** - Interfacing with ECLinPS
- AND8090/D** - AC Characteristics of ECL Devices

NB100LVEP224

PACKAGE DIMENSIONS

LQFP 64 LEAD EXPOSED PAD

848G-02
ISSUE A

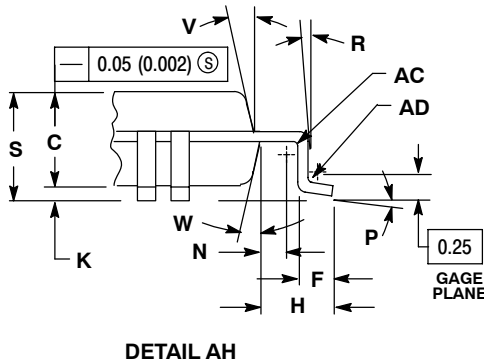
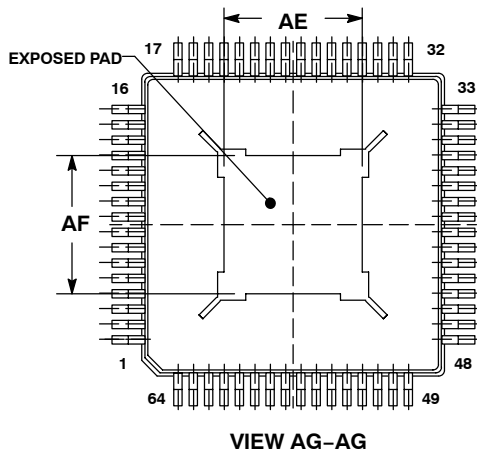
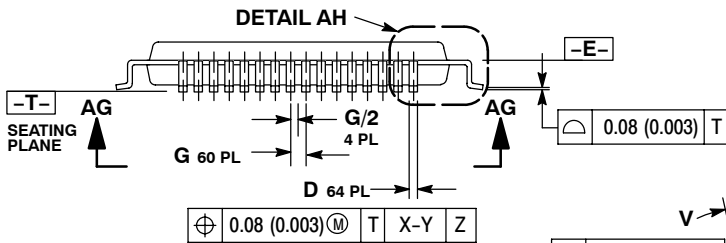
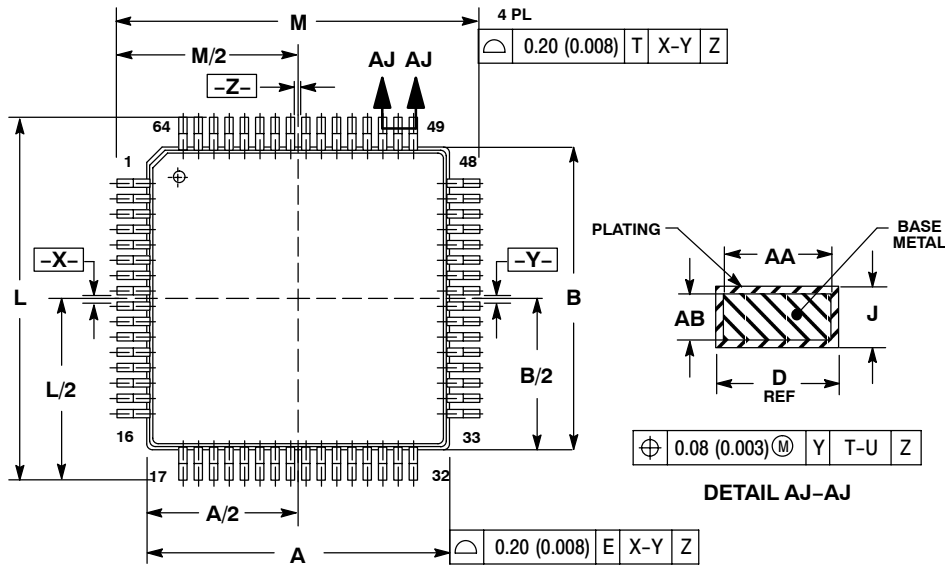

NOTES:

- DIMENSIONING AND TOLERANCING PER ANSI Y14.5M, 1982.
- CONTROLLING DIMENSION: MM.
- DATUM PLANE "E" IS LOCATED AT BOTTOM OF LEAD AND IS COINCIDENT WITH THE LEAD WHERE THE LEAD EXITS THE PLASTIC BODY AT THE BOTTOM OF THE PARTING PLANE.
- DATUM "X", "Y" AND "Z" TO BE DETERMINED AT DATUM PLANE DATUM "E".
- DIMENSIONS M AND L TO BE DETERMINED AT SEATING PLANE DATUM "T".
- DIMENSIONS A AND B DO NOT INCLUDE MOLD PROTRUSION. ALLOWABLE PROTRUSION IS 0.25 (0.010) PER SIDE. DIMENSIONS A AND B DO INCLUDE MOLD MISMATCH AND ARE DETERMINED AT DATUM PLANE "E".
- DIMENSION D DOES NOT INCLUDE DAMBAR PROTRUSION. ALLOWABLE DAMBAR PROTRUSION SHALL NOT CAUSE THE LEAD WIDTH TO EXCEED THE MAXIMUM D DIMENSION BY MORE THAN 0.08 (0.003). DAMBAR CANNOT BE LOCATED ON THE LOWER RADIUS OR THE FOOT. MINIMUM SPACE BETWEEN PROTRUSION AND ADJACENT LEAD OR PROTRUSION 0.07 (0.003).
- EXACT SHAPE OF EACH CORNER IS OPTIONAL.

DIM	MILLIMETERS		INCHES	
	MIN	MAX	MIN	MAX
A	10.00 BSC	---	0.394 BSC	---
B	10.00 BSC	---	0.394 BSC	---
C	1.35	1.45	0.053	0.057
D	0.17	0.27	0.007	0.011
F	0.45	0.75	0.018	0.030
G	0.50 BSC	---	0.020 BSC	---
H	1.00 REF	---	0.039 BSC	---
J	0.09	0.20	0.004	0.008
K	0.05	0.15	0.002	0.006
L	12.00 BSC	---	0.472 BSC	---
M	12.00 BSC	---	0.472 BSC	---
N	0.20	---	0.008	---
P	0°	7°	0°	7°
R	0°	---	0°	---
S	---	1.60	---	0.063
V	11°	13°	11°	13°
W	11°	13°	11°	13°
AA	0.17	0.23	0.007	0.009
AB	0.09	0.16	0.004	0.006
AC	0.08	---	0.003	---
AD	0.08	---	0.003	---
AE	4.50	4.78	0.180	0.188
AF	4.50	4.78	0.180	0.188

NB100LVEP224

ECLinPS is a trademark of Semiconductor Components Industries, LLC (SCILLC).

ON Semiconductor and **ON** are registered trademarks of Semiconductor Components Industries, LLC (SCILLC). SCILLC reserves the right to make changes without further notice to any products herein. SCILLC makes no warranty, representation or guarantee regarding the suitability of its products for any particular purpose, nor does SCILLC assume any liability arising out of the application or use of any product or circuit, and specifically disclaims any and all liability, including without limitation special, consequential or incidental damages. "Typical" parameters which may be provided in SCILLC data sheets and/or specifications can and do vary in different applications and actual performance may vary over time. All operating parameters, including "Typicals" must be validated for each customer application by customer's technical experts. SCILLC does not convey any license under its patent rights nor the rights of others. SCILLC products are not designed, intended, or authorized for use as components in systems intended for surgical implant into the body, or other applications intended to support or sustain life, or for any other application in which the failure of the SCILLC product could create a situation where personal injury or death may occur. Should Buyer purchase or use SCILLC products for any such unintended or unauthorized application, Buyer shall indemnify and hold SCILLC and its officers, employees, subsidiaries, affiliates, and distributors harmless against all claims, costs, damages, and expenses, and reasonable attorney fees arising out of, directly or indirectly, any claim of personal injury or death associated with such unintended or unauthorized use, even if such claim alleges that SCILLC was negligent regarding the design or manufacture of the part. SCILLC is an Equal Opportunity/Affirmative Action Employer. This literature is subject to all applicable copyright laws and is not for resale in any manner.

PUBLICATION ORDERING INFORMATION

LITERATURE FULFILLMENT:

Literature Distribution Center for ON Semiconductor
P.O. Box 5163, Denver, Colorado 80217 USA
Phone: 303-675-2175 or 800-344-3860 Toll Free USA/Canada
Fax: 303-675-2176 or 800-344-3867 Toll Free USA/Canada
Email: orderlit@onsemi.com

N. American Technical Support: 800-282-9855 Toll Free
USA/Canada
Europe, Middle East and Africa Technical Support:
Phone: 421 33 790 2910
Japan Customer Focus Center
Phone: 81-3-5773-3850

ON Semiconductor Website: www.onsemi.com
Order Literature: <http://www.onsemi.com/orderlit>

For additional information, please contact your local Sales Representative

NB100LVEP224/D