

MAXIM

825MHz to 915MHz, SiGe High-Linearity Active Mixer

General Description

The MAX9982 fully integrated SiGe mixer is optimized to meet the demanding requirements of GSM850, GSM900, and CDMA850 base-station receivers. Each high-linearity device includes a local oscillator (LO) switch, LO driver, and active mixer. On-chip baluns are also integrated to allow for single-ended RF and LO inputs. Since the active mixer provides 2dB of conversion gain, the device effectively replaces the IF amplifier stage, which typically follows most passive mixer implementations.

The MAX9982 provides exceptional linearity with an input IP3 of greater than +26dBm. The integrated LO driver allows for a wide range of LO drive levels from -5dBm to +5dBm. In addition, the built-in switch enables rapid LO selection of less than 250ns, as needed for GSM frequency-hopping applications.

The MAX9982 is available in a 20-pin QFN package (5mm x 5mm) with an exposed paddle and is specified over the -40°C to +85°C extended temperature range.

Applications

GSM850/GSM900 2G and 2.5G EDGE Base Station Receivers

Cellular cdmaOne™ and cdma2000™ Base Station Receivers

TDMA and Integrated Digital Enhanced Network (iDEN)™ Base Station Receivers

Digital and Spread-Spectrum Communication Systems

Microwave Links

Typical Application Circuit appears at end of data sheet.

cdmaOne is a trademark of CDMA Development Group.

cdma2000 is a trademark of Telecommunications Industry Association.

iDEN is a trademark of Motorola, Inc.

Features

- ◆ +26.8dBm Input IP3
- ◆ +13dBm Input 1dB Compression Point
- ◆ 825MHz to 915MHz RF Frequency Range
- ◆ 70MHz to 170MHz IF Frequency Range
- ◆ 725MHz to 1085MHz LO Frequency Range
- ◆ 2dB Conversion Gain
- ◆ 12dB Noise Figure
- ◆ -5dBm to +5dBm LO Drive
- ◆ 5V Single-Supply Operation
- ◆ Built-In LO Switch
- ◆ ESD Protection
- ◆ Internal RF and LO Baluns for Single-Ended Inputs

Ordering Information

PART	TEMP RANGE	PIN-PACKAGE
MAX9982ETP	-40°C to +85°C	20 QFN-EP* (5mm x 5mm)

*EP = exposed paddle.

Pin Configuration/ Functional Diagram

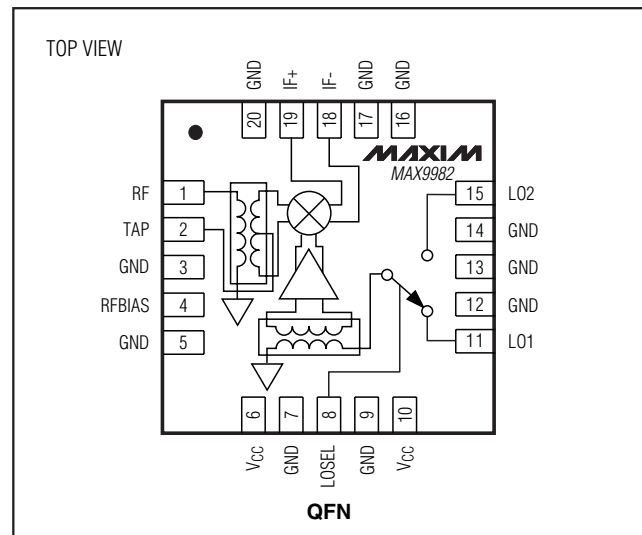
**MAX9982****MAXIM**

Maxim Integrated Products 1

For pricing, delivery, and ordering information, please contact Maxim/Dallas Direct! at 1-888-629-4642, or visit Maxim's website at www.maxim-ic.com.

825MHz to 915MHz, SiGe High-Linearity Active Mixer

ABSOLUTE MAXIMUM RATINGS

V_{CC}	-0.3V to +5.5V
IF+, IF-, RFBIA, LOSEL	-0.3V to ($V_{CC} + 0.3V$)
TAP	+5.0V
RFBIA Current	5mA
RF, LO1, LO2 Input Power	+20dBm

Continuous Power Dissipation ($T_A = +70^\circ\text{C}$)	
20-Pin QFN (derate 20.8mW/ $^\circ\text{C}$ above $T_A = +70^\circ\text{C}$)	1.66W
Operating Temperature Range	-40 $^\circ\text{C}$ to +85 $^\circ\text{C}$
Junction Temperature	+150 $^\circ\text{C}$
Storage Temperature Range	-65 $^\circ\text{C}$ to +150 $^\circ\text{C}$
Lead Temperature (soldering, 10s)	+300 $^\circ\text{C}$

Stresses beyond those listed under "Absolute Maximum Ratings" may cause permanent damage to the device. These are stress ratings only, and functional operation of the device at these or any other conditions beyond those indicated in the operational sections of the specifications is not implied. Exposure to absolute maximum rating conditions for extended periods may affect device reliability.

DC ELECTRICAL CHARACTERISTICS

(Typical Application Circuit, $V_{CC} = 4.75V$ to $5.25V$, no RF signals applied, all RF inputs and outputs terminated with 50Ω , $T_A = -40^\circ\text{C}$ to $+85^\circ\text{C}$, unless otherwise noted. Typical values are at $V_{CC} = 5V$, $T_A = +25^\circ\text{C}$, unless otherwise noted.)

PARAMETER	SYMBOL	CONDITIONS	MIN	TYP	MAX	UNITS
Supply Voltage	V_{CC}		4.75	5.00	5.25	V
Supply Current	I_{CC}		138	168	193	mA
Input High Voltage	V_{IH}		3.5		$V_{CC} + 0.3V$	V
Input Low Voltage	V_{IL}				0.4	V
LOSEL Input Current	I_{LOSEL}		-5		+5	μA

AC ELECTRICAL CHARACTERISTICS

(Typical Application Circuit, $V_{CC} = 4.75V$ to $5.25V$, $P_{LO} = -5\text{dBm}$ to $+5\text{dBm}$, $f_{RF} = 825\text{MHz}$ to 915MHz , $f_{LO} = 725\text{MHz}$ to 1085MHz , $T_A = -40^\circ\text{C}$ to $+85^\circ\text{C}$, unless otherwise noted. Typical values at $V_{CC} = +5.0V$, $P_{RF} = -5\text{dBm}$, $P_{LO} = 0\text{dBm}$, $f_{RF} = 870\text{MHz}$, $f_{LO} = 770\text{MHz}$, $T_A = +25^\circ\text{C}$, unless otherwise noted.) (Notes 1, 2)

PARAMETER	SYMBOL	CONDITIONS	MIN	TYP	MAX	UNITS
RF Frequency	f_{RF}		825		915	MHz
LO Frequency	f_{LO}		725		1085	MHz
IF Frequency	f_{IF}	Must meet RF and LO frequency range; IF matching components affect IF frequency range	70		170	MHz
LO Drive Level	P_{LO}		-5		+5	dBm
Conversion Gain (Note 3)	G_C	$V_{CC} = +5.0V$, $f_{IF} = 100\text{MHz}$, low-side injection, $P_{RF} = 0\text{dBm}$, $P_{LO} = -5\text{dBm}$	Cellular band, $f_{RF} = 825\text{MHz}$ to 850MHz		2.6	dB
			GSM band, $f_{RF} = 880\text{MHz}$ to 915MHz		2.1	
Gain Variation Over Temperature		$T_A = -40^\circ\text{C}$ to $+85^\circ\text{C}$		-0.0135		dB/ $^\circ\text{C}$
Gain Variation from Nominal		$f_{RF} = 825\text{MHz}$ to 915MHz , 3σ		± 0.6		dB

825MHz to 915MHz, SiGe High-Linearity Active Mixer

MAX9982

AC ELECTRICAL CHARACTERISTICS (continued)

(Typical Application Circuit, $V_{CC} = 4.75V$ to $5.25V$, $P_{LO} = -5dBm$ to $+5dBm$, $f_{RF} = 825MHz$ to $915MHz$, $f_{LO} = 725MHz$ to $1085MHz$, $T_A = -40^{\circ}C$ to $+85^{\circ}C$, unless otherwise noted. Typical values at $V_{CC} = +5.0V$, $P_{RF} = -5dBm$, $P_{LO} = 0dBm$, $f_{RF} = 870MHz$, $f_{LO} = 770MHz$, $T_A = +25^{\circ}C$, unless otherwise noted.) (Notes 1, 2)

PARAMETER	SYMBOL	CONDITIONS	MIN	TYP	MAX	UNITS
Conversion Loss from LO to IF		Inject $P_{IN} = -20dBm$ at $f_{LO} + 100MHz$ into LO port; measure 100MHz at IF port as P_{OUT} ; no RF signal at RF port		47		dB
Noise Figure	NF	Cellular band, $f_{RF} = 825MHz$ to $850MHz$		11.3		dB
		GSM band, $f_{RF} = 880MHz$ to $915MHz$		11.8		
Input 1dB Compression Point	P_{1dB}	Low-side injection		12.9		dBm
		High-side injection		14.5		
Input Third-Order Intercept Point	IIP3	$V_{CC} = +5.0V$, $P_{RF} = 0dBm$, $P_{LO} = -5dBm$, $T_A = +25^{\circ}C$ (Notes 3, 4)		26.8		dBm
Input Third-Order Intercept Point Variation Over Temperature	$\Delta IIP3$	$T_A = -40^{\circ}C$ to $+85^{\circ}C$		± 0.5		dB
2 RF - 2 LO Spur Rejection	2×2	$f_{RF} = 915$, $f_{LO} = 815MHz$, $f_{SPUR} = 865MHz$, $P_{RF} = -5dBm$	$P_{LO} = +5dBm$		65	dBc
			$P_{LO} = 0dBm$		57	
3 RF - 3 LO Spur Rejection	3×3	$f_{RF} = 915$, $f_{LO} = 815MHz$, $f_{SPUR} = 848.3MHz$, $P_{RF} = -5dBm$	$P_{LO} = +5dBm$		89	dBc
			$P_{LO} = 0dBm$		89	
Maximum LO Leakage at RF Port		$P_{LO} = -5dBm$ to $+5dBm$, $f_{LO} = 725MHz$ to $1085MHz$		-40		dBm
Maximum LO Leakage at IF Port		$P_{LO} = -5dBm$ to $+5dBm$, $f_{LO} = 725MHz$ to $1085MHz$		-28		dBm
Minimum RF to IF Isolation		$P_{LO} = -5dBm$ to $+5dBm$, $f_{RF} = 825MHz$ to $915MHz$		11		dB
LO1 to LO2 Isolation		$f_{RF} = 825MHz$ to $915MHz$, $P_{LO1} = P_{LO2} = +5dBm$, $f_{IF} = 100MHz$ (Note 5)		51		dB
LO Switching Time		50% of LOSEL to IF settled within 2°		250		ns
RF Return Loss				19		dB
LO Return Loss		LO port active		20		dB
		LO port inactive		12		
IF Return Loss		RF and LO terminated (Note 6)		15		dB

Note 1: Guaranteed by design and characterization.

Note 2: All limits reflect losses of external components. Output measurements taken at IF OUT of Typical Application Circuit.

Note 3: Production tested.

Note 4: Two tones at 1MHz spacing, 0dBm each at RF port.

Note 5: Measured at IF port at IF frequency. LO1 and LO2 are offset by 1MHz.

Note 6: IF return loss can be optimized by external matching components.

825MHz to 915MHz, SiGe High-Linearity Active Mixer

Typical Operating Characteristics

(Typical Application Circuit, $V_{CC} = 5V$, $f_{IF} = 100MHz$, $P_{RF} = -5dBm$, $P_{LO} = 0dBm$, $T_A = +25^\circ C$, unless otherwise noted.)

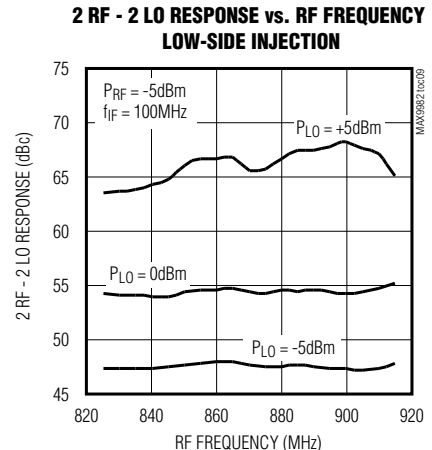
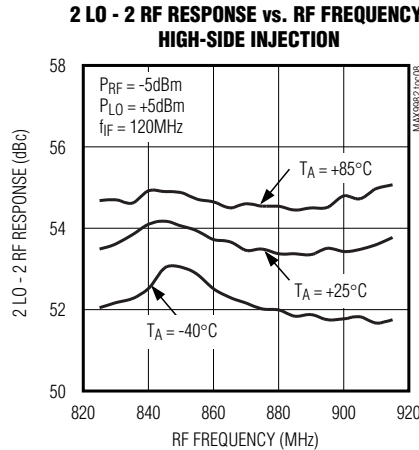
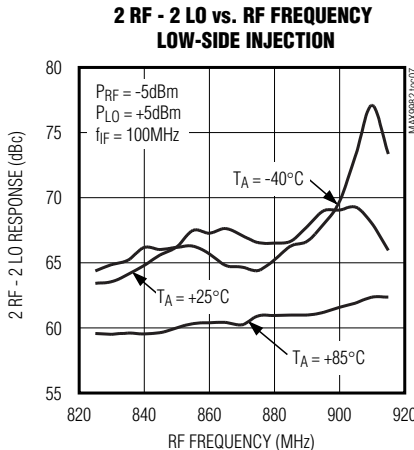
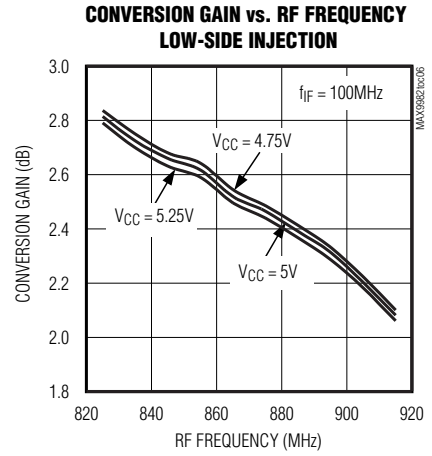
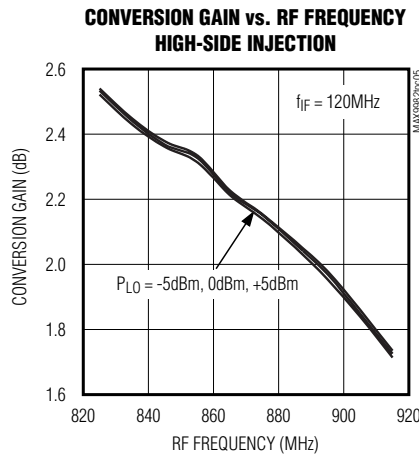
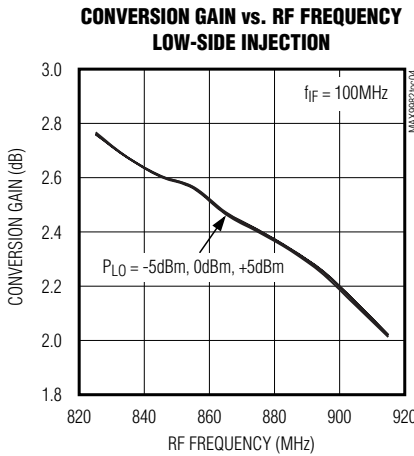
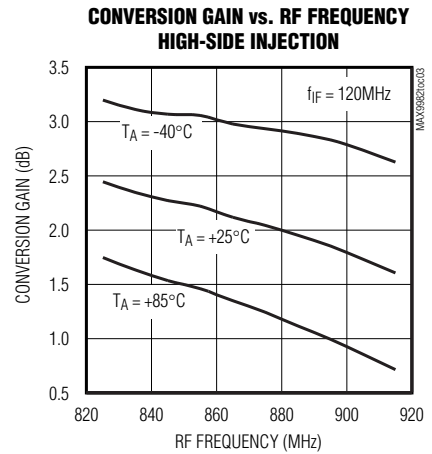
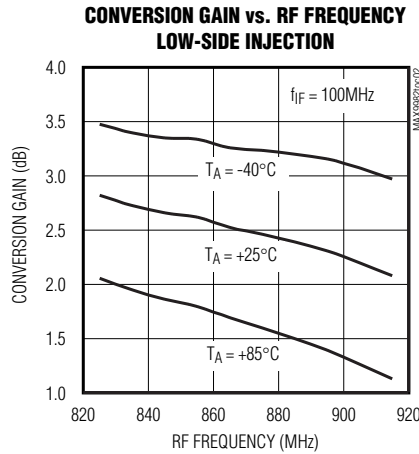
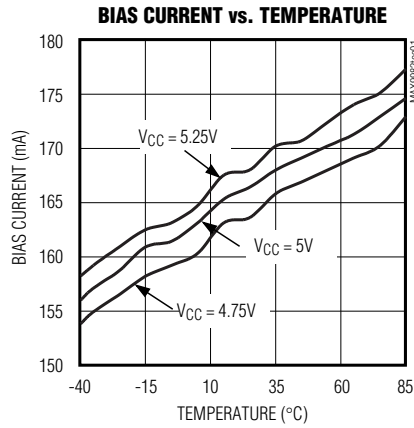

825MHz to 915MHz, SiGe High-Linearity Active Mixer

Typical Operating Characteristics (continued)

(Typical Application Circuit, $V_{CC} = 5V$, $f_{IF} = 100MHz$, $P_{RF} = -5dBm$, $P_{LO} = 0dBm$, $T_A = +25^\circ C$, unless otherwise noted.)

MAX9982

**2 LO - 2 RF RESPONSE vs. RF FREQUENCY
HIGH-SIDE INJECTION**

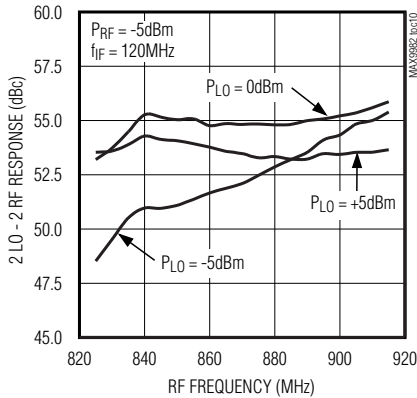

**INPUT IP3 vs. RF FREQUENCY
LOW-SIDE INJECTION**

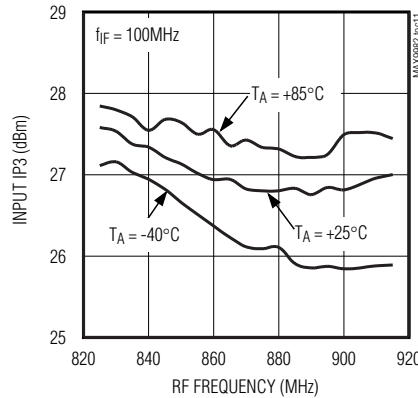

**INPUT IP3 vs. RF FREQUENCY
HIGH-SIDE INJECTION**

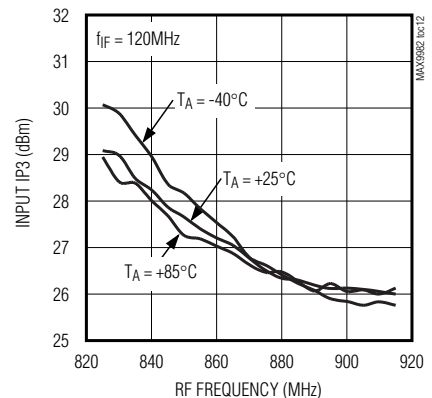

**INPUT IP3 vs. RF FREQUENCY
LOW-SIDE INJECTION**

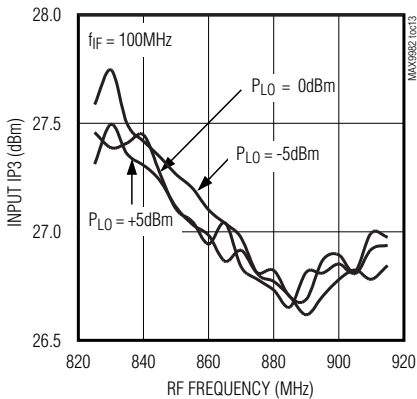

**INPUT IP3 vs. RF FREQUENCY
HIGH-SIDE INJECTION**

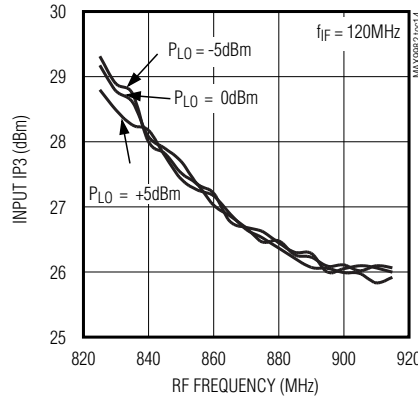

**INPUT IP3 vs. RF FREQUENCY
LOW-SIDE INJECTION**

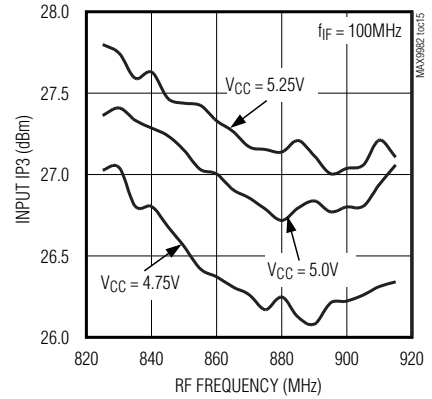

**INPUT P1dB vs. RF FREQUENCY
LOW-SIDE INJECTION**

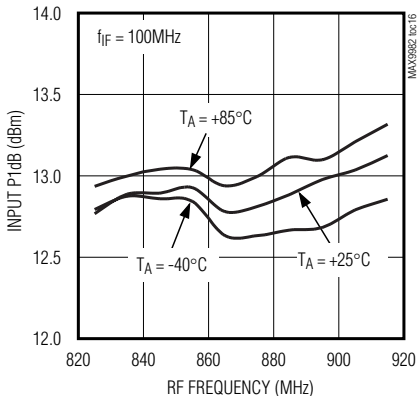

**INPUT P1dB vs. RF FREQUENCY
HIGH-SIDE INJECTION**

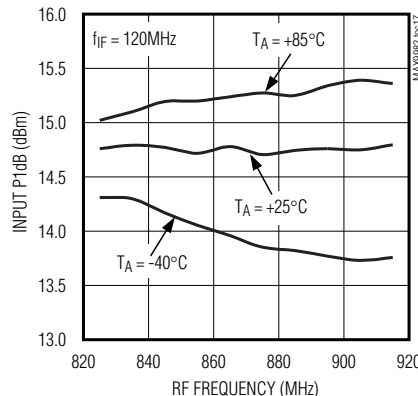

**INPUT P1dB vs. RF FREQUENCY
LOW-SIDE INJECTION**

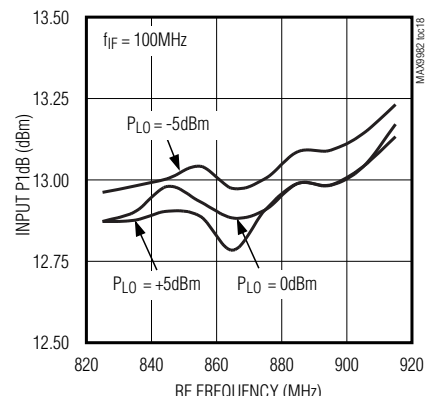

825MHz to 915MHz, SiGe High-Linearity Active Mixer

Typical Operating Characteristics (continued)

(Typical Application Circuit, $V_{CC} = 5V$, $f_{IF} = 100MHz$, $P_{RF} = -5dBm$, $P_{LO} = 0dBm$, $T_A = +25^{\circ}C$, unless otherwise noted.)

**INPUT P1dB vs. RF FREQUENCY
LOW-SIDE INJECTION**

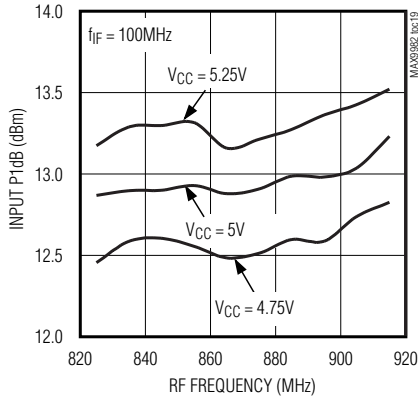

**LO SWITCH ISOLATION vs. RF FREQUENCY
LOW-SIDE INJECTION**

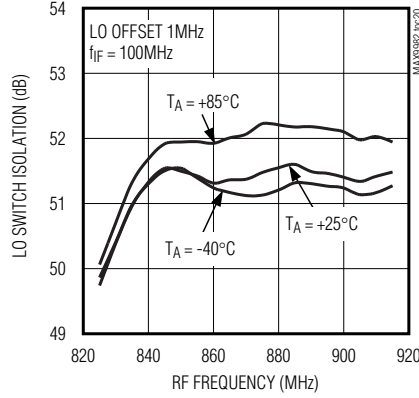

**LO SWITCH ISOLATION vs. RF FREQUENCY
HIGH-SIDE INJECTION**

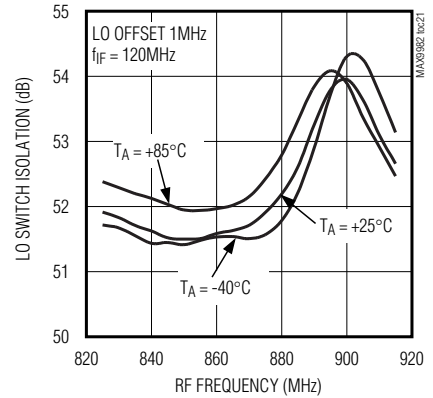

**LO SWITCH ISOLATION vs. RF FREQUENCY
LOW-SIDE INJECTION**

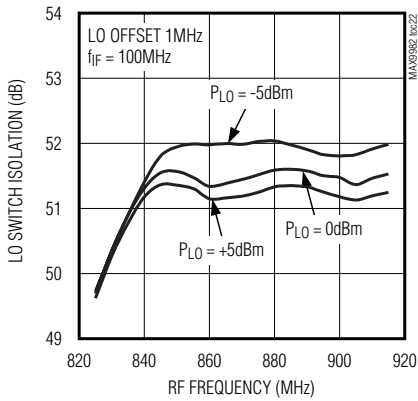

**LO LEAKAGE AT IF PORT
vs. LO FREQUENCY**

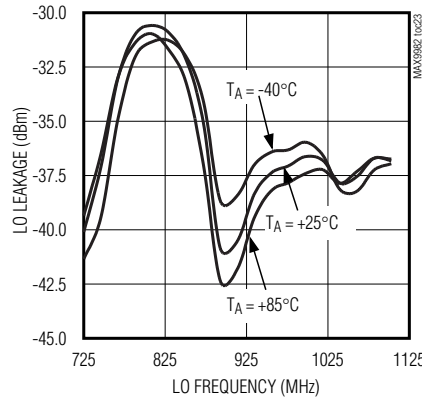

**LO LEAKAGE AT IF PORT
vs. LO FREQUENCY**

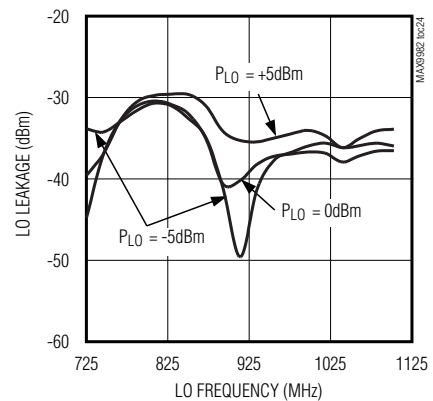

**LO LEAKAGE AT RF PORT
vs. LO FREQUENCY**

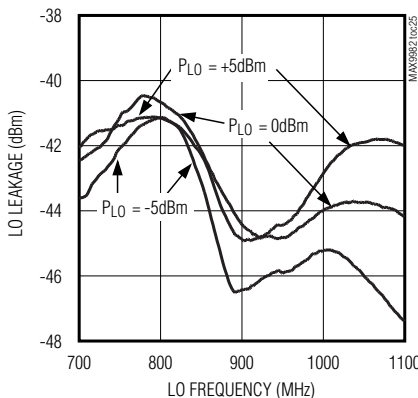

**RF LEAKAGE AT IF PORT
vs. RF FREQUENCY**

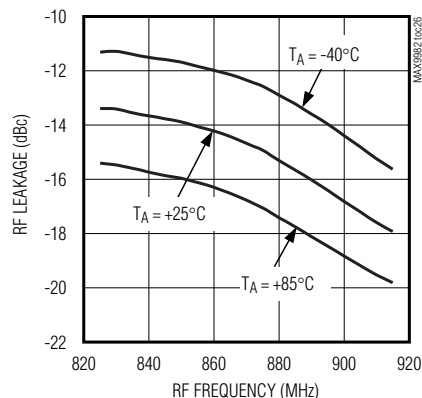

**RF LEAKAGE AT IF PORT
vs. RF FREQUENCY**

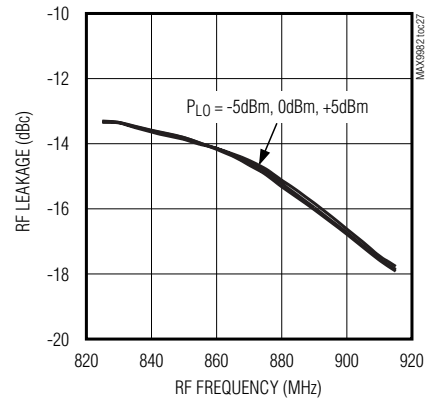

825MHz to 915MHz, SiGe High-Linearity Active Mixer

Typical Operating Characteristics (continued)

(Typical Application Circuit, $V_{CC} = 5V$, $f_{IF} = 100MHz$, $P_{RF} = -5dBm$, $P_{LO} = 0dBm$, $T_A = +25^\circ C$, unless otherwise noted.)

MAX9982

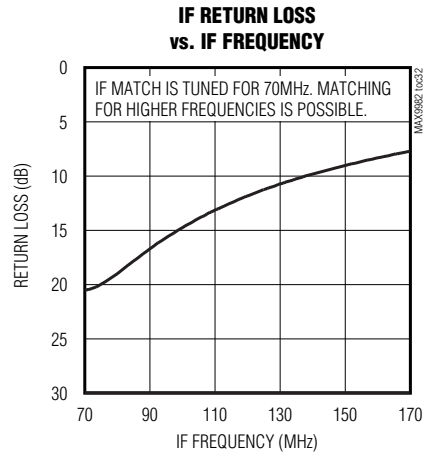
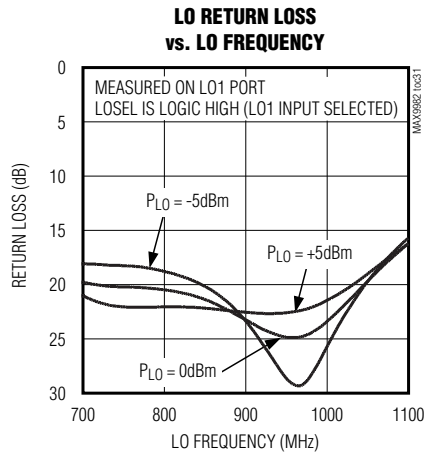
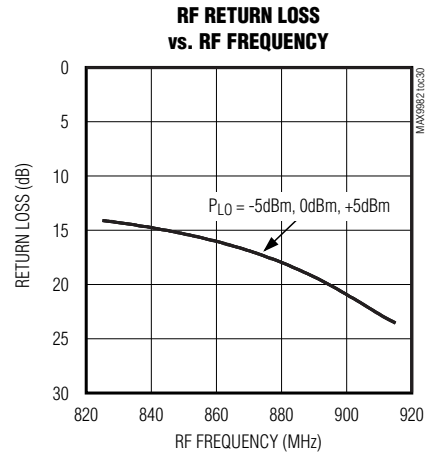
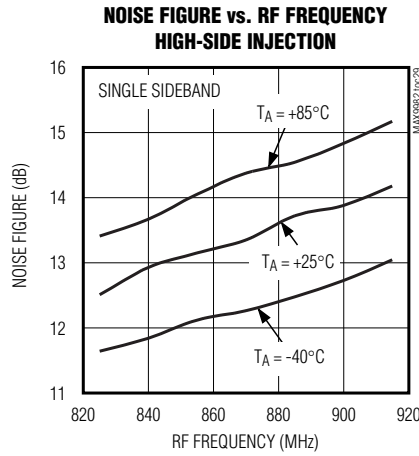
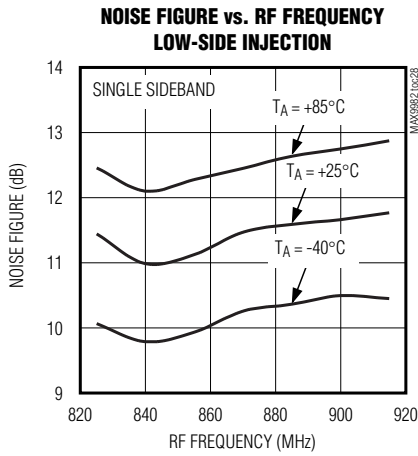

825MHz to 915MHz, SiGe High-Linearity Active Mixer

Pin Description

PIN	NAME	FUNCTION
1	RF	RF Input. This input is internally matched to 50Ω and is DC shorted to ground.
2	TAP	RF Balun Center Tap. Connect bypass capacitors from this pin to ground.
3, 5, 7, 9, 12, 13, 14, 16, 17, 20, EP	GND	Ground
4	RFBIAS	Bias control for the mixer. Connect a 249Ω resistor from this pin to ground to set the bias current for the mixer.
6, 10	VCC	Power-Supply Connections. Connect a 0.1μF bypass capacitor from each VCC pin to ground.
8	LOSEL	Local Oscillator Select. Set this pin to logic HIGH to select LO1; set to logic LOW to select LO2.
11	LO1	Local Oscillator Input 1. This input is internally matched to 50Ω and is DC shorted to ground when selected. Requires a DC-blocking capacitor.
15	LO2	Local Oscillator Input 2. This input is internally matched to 50Ω and is DC shorted to ground when selected.
18, 19	IF-, IF+	Differential IF Output. Connect 560nH pullup inductors and 137Ω pullup resistors from each of these pins to VCC for a 70MHz to 120MHz IF range.

Table 1. Component List

COMPONENT	VALUE	SIZE	PART
C1, C2, C6, C7	33pF	0603	Murata GRM1885C1H330J
C3	0.033μF	0603	Murata GRM188R71E333K
C4, C5	0.1μF	0603	Murata GRM188FS1E104Z
C8, C11	220pF	0603	Murata GRM1885C1H221J
C9, C10	330pF	0603	Murata GRM1885C1H331J
L1, L2	560nH	1008	Coilcraft 1008CS-561XJBB
R1	249Ω ±1%	0603	Panasonic ERJ-3EKF2490V
R3, R4	137Ω ±1%	0603	Panasonic ERJ-3EKF1370V
T1	4:1 (200:50)	—	Mini-Circuits TC4-1W-7A
U1	—	20-pin 5mm x 5mm QFN	MAX9982ETP

Detailed Description

The MAX9982 downconverter mixer is designed for GSM and CDMA base station receivers with an RF frequency between 825MHz and 915MHz. It implements an active mixer that provides 2dB of overall conversion gain to the receive path, removing the need for an additional IF amplifier. The mixer has excellent input IP3 measuring +26.8dBm. The device also features integrated RF and LO baluns that allow the mixers to be driven with single-ended signals.

RF Inputs

The MAX9982 has one input (RF) that is internally matched to 50Ω requiring no external matching components. A 33pF DC-blocking capacitor is required at the input since the input is internally DC shorted to ground through a balun. The input frequency range is 825MHz to 915MHz.

LO Inputs

The mixer can be used for either high-side or low-side injection applications with an LO frequency range of

825MHz to 915MHz, SiGe High-Linearity Active Mixer

MAX9982

725MHz to 1085MHz. An internal LO switch allows for switching between two single-ended LO ports; this is useful for fast frequency changes/frequency hopping. LO switching time is typically less than 250ns. The switch is controlled by a digital input (LOSEL) that when high, selects LO1 and when low, selects LO2.

Internal LO buffers allow for a wide power range on the LO ports. The LO signal power can vary from -5dBm to +5dBm. LO1 and LO2 are internally matched to 50 Ω , so only a 33pF DC-blocking capacitor is required at each LO port.

IF Outputs

This mixer has an IF frequency range of 70MHz to 170MHz. The differential IF output ports require external pullup inductors to V_{CC} to resonate out the differential on-chip capacitance of 1.8pF. See the *Typical Application Circuit* for recommended component values for an IF optimized for 70MHz to 100MHz. Higher IF frequencies can be optimized by reducing the values of L1 and L2.

Removing the ground plane from underneath L1 and L2 reduces parasitic capacitive loading and improves VSWR.

Bias Circuitry

Connect a bias resistor from RFBIAS to ground to set the mixer bias current. A nominal resistor value of 249 Ω sets an input IP3 of +26.8dBm and supply current of 168mA.

Applications Information

Layout Considerations

A properly designed PC board is an essential part of any RF/microwave circuit. Keep RF signal lines as short as possible to reduce losses, radiation, and inductance. For best performance, route the ground pin traces directly to the exposed paddle underneath the package. Solder the exposed pad on the bottom of the device package evenly to the board ground plane to provide a heat transfer path along with RF grounding. If the PC board ground plane is not immediately available on the top metal layer, provide multiple vias between the exposed paddle connection and the PC board ground plane.

Power-Supply Bypassing

Proper voltage supply bypassing is essential for high-frequency circuit stability. Bypass each V_{CC} pin with a 0.1 μ F capacitor. Bypass TAP by placing a 33pF (C2) to ground within 100 mils of the TAP pin.

Chip Information

TRANSISTOR COUNT: 179

PROCESS: BiCMOS

825MHz to 915MHz, SiGe High-Linearity Active Mixer

Typical Application Circuit

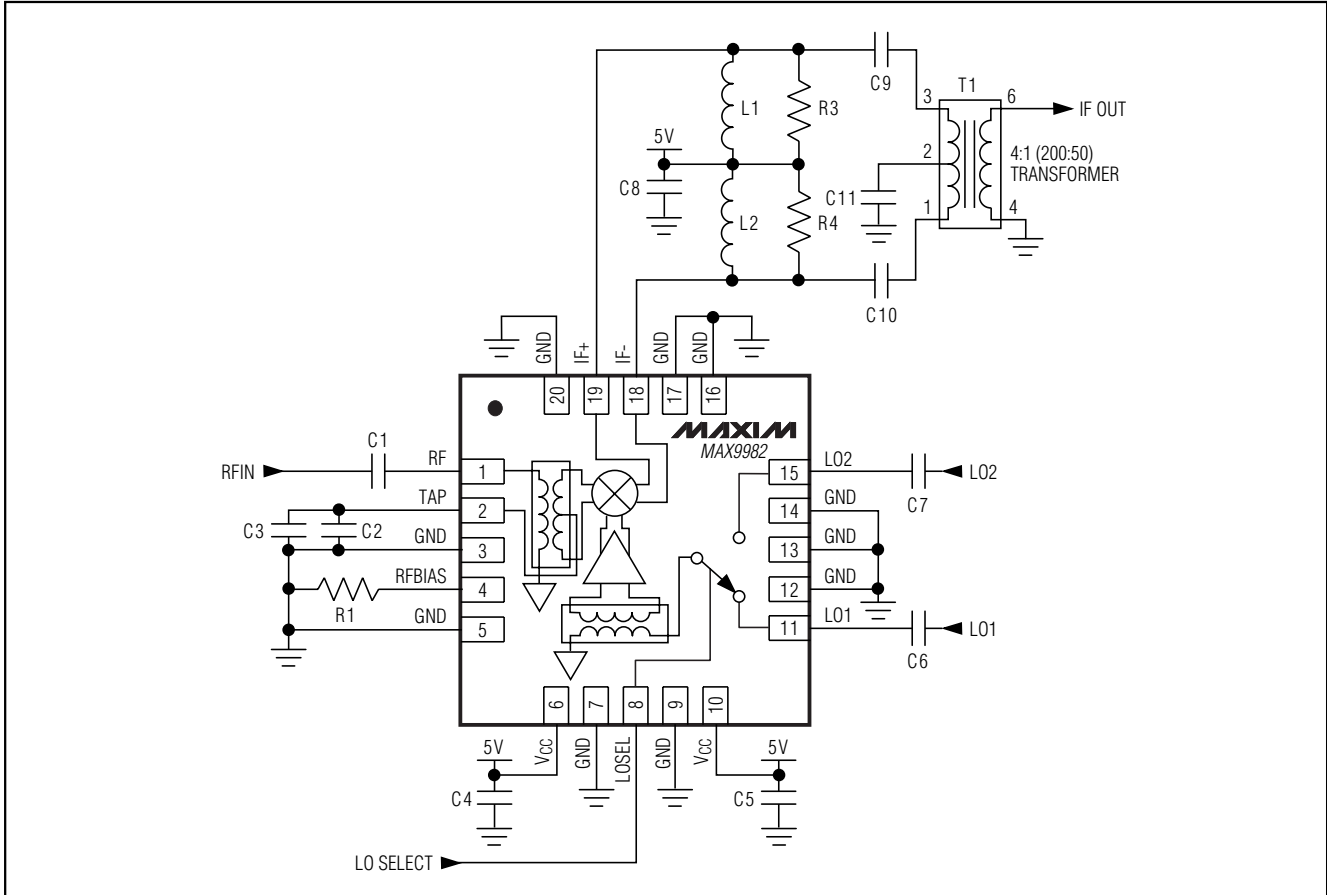

825MHz to 915MHz, SiGe High-Linearity Active Mixer

Package Information

(The package drawing(s) in this data sheet may not reflect the most current specifications. For the latest package outline information, go to www.maxim-ic.com/packages.)

MAX9982

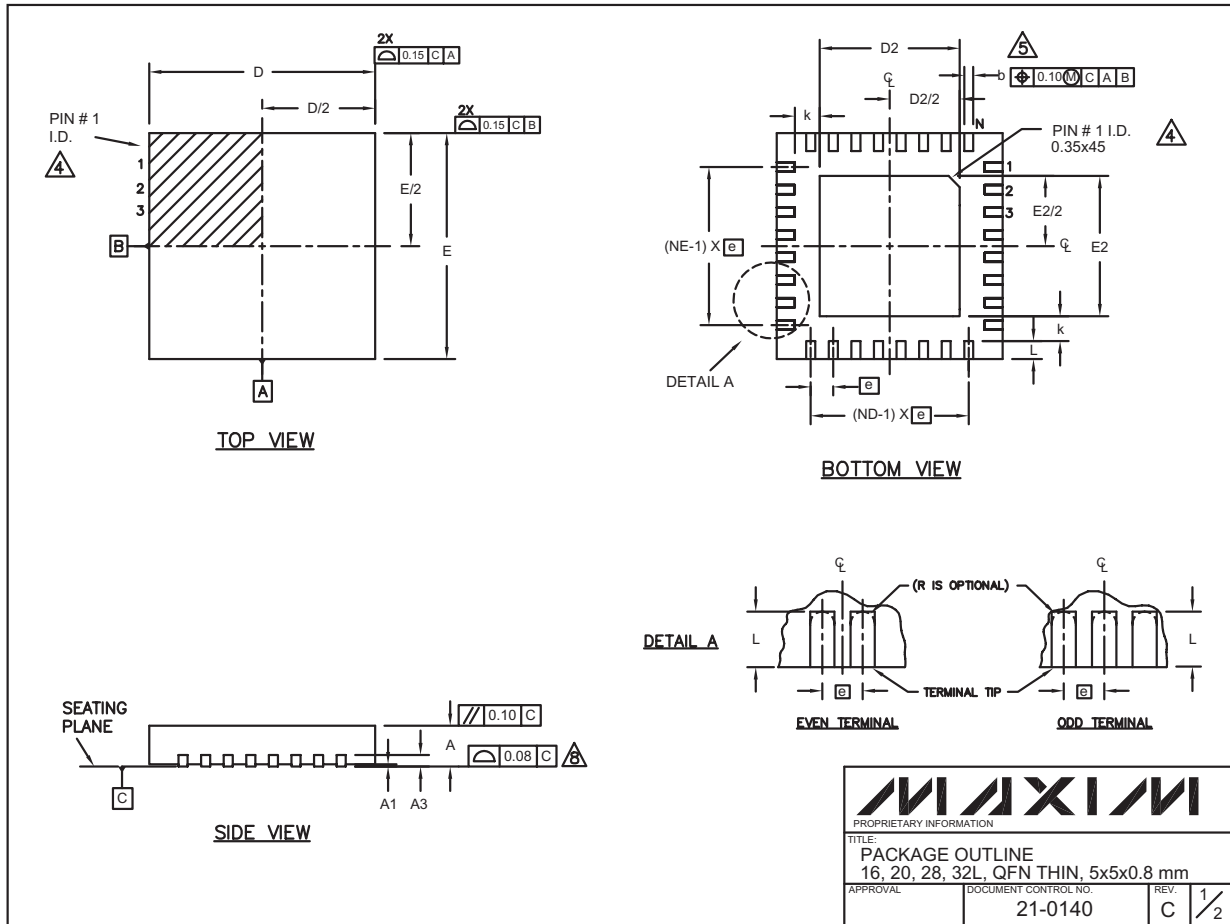

825MHz to 915MHz, SiGe High-Linearity Active Mixer

Package Information (continued)

(The package drawing(s) in this data sheet may not reflect the most current specifications. For the latest package outline information, go to www.maxim-ic.com/packages.)

COMMON DIMENSIONS													EXPOSED PAD VARIATIONS							
PKG. SYMBOL	16L 5x5			20L 5x5			28L 5x5			32L 5x5			PKG. CODES	D2			E2			
	MIN.	NOM.	MAX.	MIN.	NOM.	MAX.	MIN.	NOM.	MAX.	MIN.	NOM.	MAX.		MIN.	NOM.	MAX.	MIN.	NOM.	MAX.	
A	0.70	0.75	0.80	0.70	0.75	0.80	0.70	0.75	0.80	0.70	0.75	0.80	T1655-1	3.00	3.10	3.20	3.00	3.10	3.20	
A1	0	0.02	0.05	0	0.02	0.05	0	0.02	0.05	0	0.02	0.05	T2055-2	3.00	3.10	3.20	3.00	3.10	3.20	
A3	0.20 REF.			0.20 REF.			0.20 REF.			0.20 REF.			T2855-1	3.15	3.25	3.35	3.15	3.25	3.35	
b	0.25	0.30	0.35	0.25	0.30	0.35	0.20	0.25	0.30	0.20	0.25	0.30	T2855-2	2.60	2.70	2.80	2.60	2.70	2.80	
D	4.90	5.00	5.10	4.90	5.00	5.10	4.90	5.00	5.10	4.90	5.00	5.10	T3255-2	3.00	3.10	3.20	3.00	3.10	3.20	
E	4.90	5.00	5.10	4.90	5.00	5.10	4.90	5.00	5.10	4.90	5.00	5.10								
e	0.80 BSC.			0.65 BSC.			0.50 BSC.			0.50 BSC.										
k	0.25	-	-	0.25	-	-	0.25	-	-	0.25	-	-								
L	0.45	0.55	0.65	0.45	0.55	0.65	0.45	0.55	0.65	0.45	0.55	0.65								
N	16			20			28			32										
ND	4			5			7			8										
NE	4			5			7			8										
JEDEC	WHHB			WHHC			WHHD-1			WHHD-2										

NOTES:

- DIMENSIONING & TOLERANCING CONFORM TO ASME Y14.5M-1994.
- ALL DIMENSIONS ARE IN MILLIMETERS. ANGLES ARE IN DEGREES.
- N IS THE TOTAL NUMBER OF TERMINALS.
- THE TERMINAL #1 IDENTIFIER AND TERMINAL NUMBERING CONVENTION SHALL CONFORM TO JESD 95-1 SPP-012. DETAILS OF TERMINAL #1 IDENTIFIER ARE OPTIONAL, BUT MUST BE LOCATED WITHIN THE ZONE INDICATED. THE TERMINAL #1 IDENTIFIER MAY BE EITHER A MOLD OR MARKED FEATURE.
- DIMENSION b APPLIES TO METALLIZED TERMINAL AND IS MEASURED BETWEEN 0.25 mm AND 0.30 mm FROM TERMINAL TIP.
- ND AND NE REFER TO THE NUMBER OF TERMINALS ON EACH D AND E SIDE RESPECTIVELY.
- DEPOPULATION IS POSSIBLE IN A SYMMETRICAL FASHION.
- COPLANARITY APPLIES TO THE EXPOSED HEAT SINK SLUG AS WELL AS THE TERMINALS.
- DRAWING CONFORMS TO JEDEC MO220.
- WARPAGE SHALL NOT EXCEED 0.10 mm.

PROPRIETARY INFORMATION		
TITLE: PACKAGE OUTLINE 16, 20, 28, 32L, QFN THIN, 5x5x0.8 mm		
APPROVAL	DOCUMENT CONTROL NO. 21-0140	REV. C 2/2

Maxim cannot assume responsibility for use of any circuitry other than circuitry entirely embodied in a Maxim product. No circuit patent licenses are implied. Maxim reserves the right to change the circuitry and specifications without notice at any time.

12 **Maxim Integrated Products, 120 San Gabriel Drive, Sunnyvale, CA 94086 408-737-7600**