

# LMV1032-06/LMV1032-15/LMV1032-25 Amplifiers for 3 Wire Analog Electret Microphones

## General Description

The LMV1032 is an audio amplifier series for small form factor electret microphones. It is designed to replace the JFET preamp currently being used. The LMV1032 series is ideal for extended battery life applications, such as a blue-tooth communication link. The addition of a third pin in electret microphones that incorporate the LMV1032 allows for a dramatic reduction in supply current as compared to the JFET equipped electret microphone. Microphone supply current is thus reduced to 60  $\mu$ A, assuring longer battery life. The LMV1032 series is guaranteed for supply voltages from 1.7V to 5V, and has fixed voltage gains of 6 dB, 15 dB and 25 dB.

The LMV1032 series offers low output impedance over the voice bandwidth, excellent power supply rejection (PSRR), and stability over temperature.

The devices are offered in space saving 4-bump ultra thin micro SMD (TM) lead free package and are thus ideally suited for the form factor of miniature electret microphone packages.

## Features

(Typical LMV1032-06, 1.7V Supply; Unless Otherwise Noted)

■ Output voltage noise (A-weighted)	-97 dBV
■ Low supply current	60 $\mu$ A
■ Supply voltage	1.7V to 5V
■ PSRR	84 dB
■ Signal to noise ratio	58 dB
■ Input capacitance	2 pF
■ Input impedance	>100 M $\Omega$
■ Output impedance	<200 $\Omega$
■ Max input signal	300 mV <sub>PP</sub>
■ Temperature range	-40°C to 85°C
■ Offered in 1.13 x 1.13 x 0.4mm Ultra Thin micro SMD lead free (NOPB) package	

## Applications

- Mobile communications - Bluetooth
- Automotive accessories
- Cellular phones
- PDAs
- Accessory microphone products

## Block Diagram

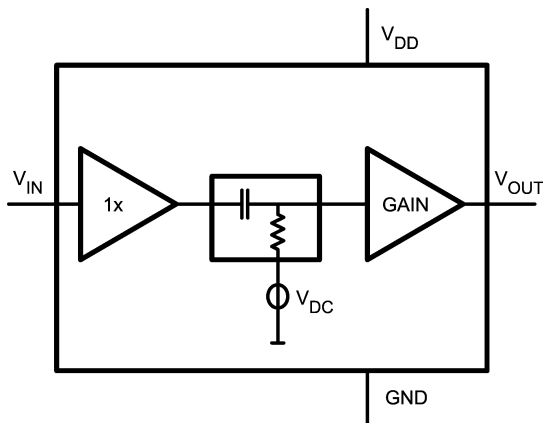

20084201

## Electret Microphone

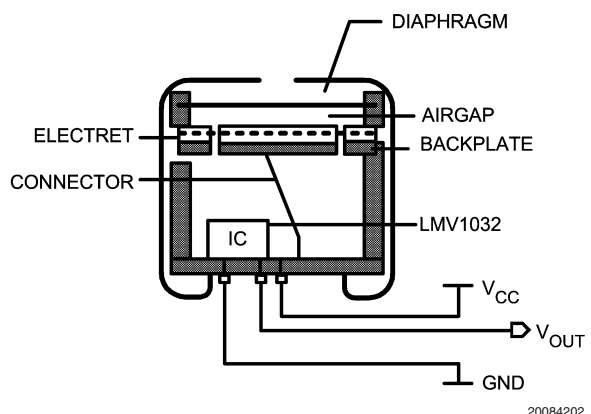

20084202

**Absolute Maximum Ratings** (Note 1)

If Military/Aerospace specified devices are required, please contact the National Semiconductor Sales Office/Distributors for availability and specifications.

ESD Tolerance (Note 2)

Human Body Model

2500V

Machine Model

250V

Supply Voltage

 $V_{DD} - GND$ 

5.5V

Storage Temperature Range

-65°C to 150°C

Junction Temperature (Note 6)

150°C max

Mounting Temperature

Infrared or Convection (20 sec.)

235°C

**Operating Ratings** (Note 1)

Supply Voltage

1.7V to 5V

Temperature Range

-40°C to +85°C

**1.7V and 5V Electrical Characteristics** (Note 3)

Unless otherwise specified, all limits guaranteed for  $T_J = 25^\circ\text{C}$  and  $V_{DD} = 1.7\text{V}$  and  $5\text{V}$ . **Boldface** limits apply at the temperature extremes.

Symbol	Parameter	Conditions	Min (Note 4)	Typ (Note 5)	Max (Note 4)	Units	
$I_{DD}$	Supply Current	$V_{IN} = GND$		60	85 <b>100</b>	$\mu\text{A}$	
SNR	Signal to Noise Ratio	$V_{DD} = 1.7\text{V}$ $V_{IN} = 18\text{ mV}_{PP}$ $f = 1\text{ kHz}$	LMV1032-06	58		dB	
			LMV1032-15	61			
			LMV1032-25	61			
		$V_{DD} = 5\text{V}$ $V_{IN} = 18\text{ mV}_{PP}$ $f = 1\text{ kHz}$	LMV1032-06	59			
			LMV1036-15	61			
			LMV1032-25	62			
PSRR	Power Supply Rejection Ratio	$1.7\text{V} < V_{DD} < 5\text{V}$	LMV1032-06	65 <b>60</b>	75	dB	
			LMV1032-15	60 <b>55</b>	70		
			LMV1032-25	55 <b>50</b>	65		
$V_{IN}$	Max Input Signal	$f = 1\text{ kHz}$ and THD+N < 1%	LMV1032-06	300		$\text{mV}_{PP}$	
			LMV1032-15	170			
			LMV1032-25	60			
$f_{LOW}$	Lower -3 dB Roll Off Frequency	$R_{SOURCE} = 50\Omega$ $V_{IN} = 18\text{ mV}_{PP}$		70		Hz	
$f_{HIGH}$	Upper -3 dB Roll Off Frequency	$R_{SOURCE} = 50\Omega$ $V_{IN} = 18\text{ mV}_{PP}$	LMV1032-06	120		kHz	
			LMV1032-15	75			
			LMV1032-25	21			
$e_n$	Output Noise	A-Weighted	LMV1032-06	-97		dBV	
			LMV1032-15	-89			
			LMV1032-25	-80			
$V_{OUT}$	Output Voltage	$V_{IN} = GND$	LMV1032-06	<b>100</b>	300	<b>500</b>	mV
			LMV1032-15	<b>250</b>	500	<b>750</b>	
			LMV1032-25	<b>300</b>	600	<b>1000</b>	
$R_O$	Output Impedance	$f = 1\text{ kHz}$		<200		$\Omega$	
$I_O$	Output Current	$V_{DD} = 1.7\text{V}$ , $V_{OUT} = 1.7\text{V}$ , Sinking	0.9 <b>0.5</b>	2.3		mA	
		$V_{DD} = 1.7\text{V}$ , $V_{OUT} = 0\text{V}$ , Sourcing	0.3 <b>0.2</b>	0.64			
		$V_{DD} = 5\text{V}$ , $V_{OUT} = 1.7\text{V}$ , Sinking	0.9 <b>0.5</b>	2.4			
		$V_{DD} = 5\text{V}$ , $V_{OUT} = 0\text{V}$ , Sourcing	0.4 <b>0.1</b>	1.46			

## 1.7V and 5V Electrical Characteristics (Note 3) (Continued)

Unless otherwise specified, all limits guaranteed for  $T_J = 25^\circ\text{C}$  and  $V_{DD} = 1.7\text{V}$  and  $5\text{V}$ . **Boldface** limits apply at the temperature extremes.

Symbol	Parameter	Conditions	Min (Note 4)	Typ (Note 5)	Max (Note 4)	Units	
THD	Total Harmonic Distortion	f = 1 kHz $V_{IN} = 18\text{ mV}_{PP}$	LMV1032-06		0.11	%	
			LMV1032-15		0.13		
			LMV1032-25		0.35		
$C_{IN}$	Input Capacitance			2		pF	
$Z_{IN}$	Input Impedance			>100		M $\Omega$	
$A_V$	Gain	f = 1 kHz $V_{IN} = 18\text{ mV}_{PP}$	LMV1032-06	5.5	6.2	6.7	dB
			LMV1032-15	<b>14.8</b>	15.4	16	
			LMV1032-25	<b>24.8</b>	25.5	26.2	
			<b>24</b>		<b>27</b>		

**Note 1:** Absolute Maximum Ratings indicate limits beyond which damage to the device may occur. Operating Ratings indicate conditions for which the device is intended to be functional, but specific performance is not guaranteed. For guaranteed specifications and the test conditions, see the Electrical Characteristics.

**Note 2:** Human Body Model (HBM) is 1.5 k $\Omega$  in series with 100 pF.

**Note 3:** Electrical Table values apply only for factory testing conditions at the temperature indicated. Factory testing conditions result in very limited self-heating of the device such that  $T_J = T_A$ . No guarantee of parametric performance is indicated in the electrical tables under conditions of internal self-heating where  $T_J > T_A$ .

**Note 4:** All limits are guaranteed by design or statistical analysis.

**Note 5:** Typical values represent the most likely parametric norm.

**Note 6:** The maximum power dissipation is a function of  $T_{J(MAX)}$ ,  $\theta_{JA}$  and  $T_A$ . The maximum allowable power dissipation at any ambient temperature is  $P_D = (T_{J(MAX)} - T_A)/\theta_{JA}$ . All numbers apply for packages soldered directly into a PC board.

## Connection Diagram

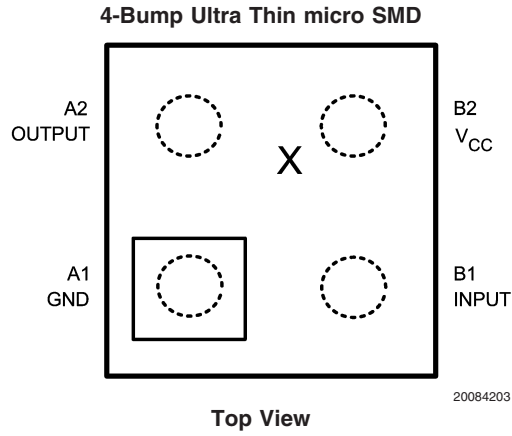

**Note:** - Pin numbers are referenced to package marking text orientation.

- The actual physical placement of the package marking will vary slightly from part to part. The package will designate the date code and will vary considerably. Package marking does not correlate to device type in any way.

## Ordering Information

Package	Part Number	Package Marking	Transport Media	NSC Drawing
4-Bump Ultra Thin micro SMD lead free	LMV1032UP-06	Date Code	250 Units Tape and Reel	UPA04QQA
	LMV1032UPX-06		3k Units Tape and Reel	
	LMV1032UP-15	Date Code	250 Units Tape and Reel	
	LMV1032UPX-15		3k Units Tape and Reel	
	LMV1032UP-25	Date Code	250 Units Tape and Reel	
	LMV1032UPX-25		3k Units Tape and Reel	

**Note:** The LMV1032 series is offered **only** with lead free (NOPB) solder bumps.  
The LMV1032 series replaces the LMV1014.

# Typical Performance Characteristics

25°C

Unless otherwise specified,  $V_S = 1.7V$ , single supply,  $T_A = 25^\circ C$

Supply Current vs. Supply Voltage (LMV1032-06)

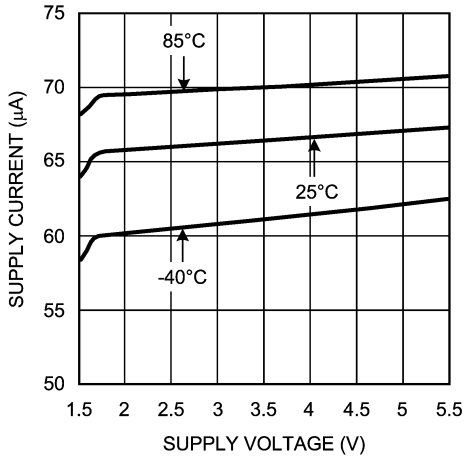

20084204

Supply Current vs. Supply Voltage (LMV1032-15)

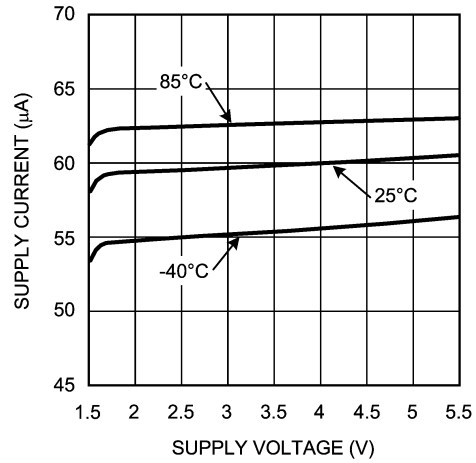

20084213

Supply Current vs. Supply Voltage (LMV1032-25)

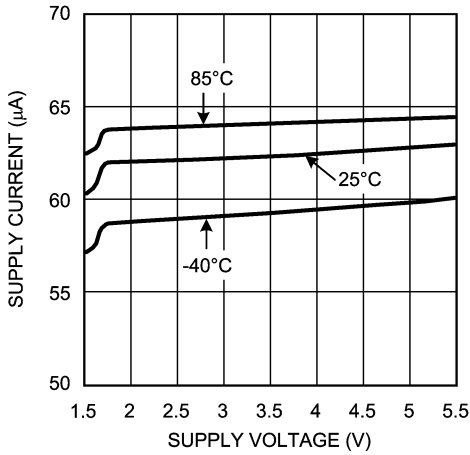

20084214

Closed Loop Gain and Phase vs. Frequency (LMV1032-06)

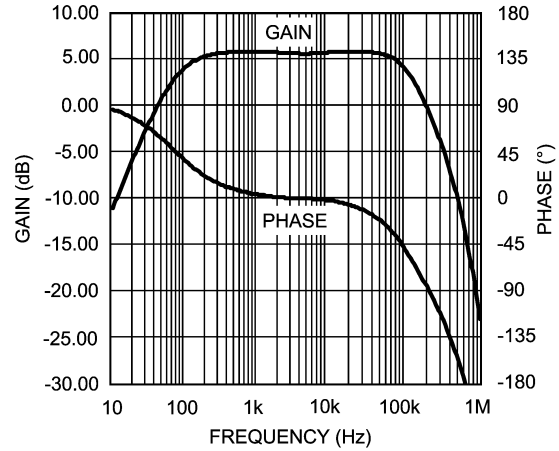

20084205

Closed Loop Gain and Phase vs. Frequency (LMV1032-15)

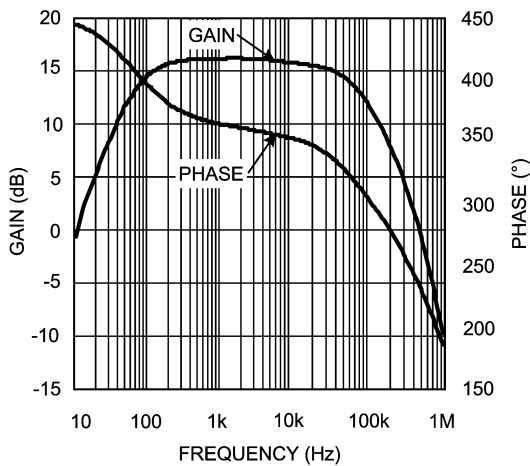

20084215

Closed Loop Gain and Phase vs. Frequency (LMV1032-25)

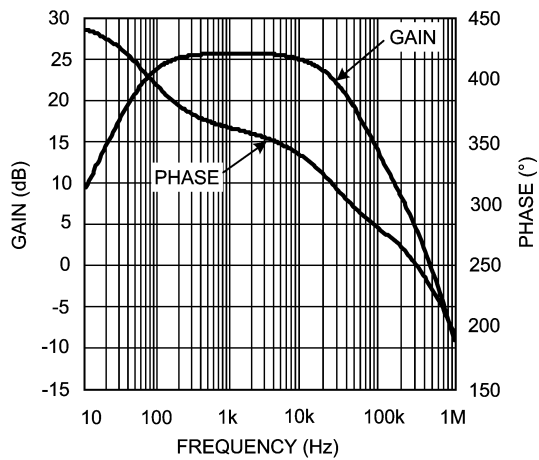

20084216

**Typical Performance Characteristics** Unless otherwise specified,  $V_S = 1.7V$ , single supply,  $T_A = 25^\circ C$  (Continued)

**Power Supply Rejection Ratio vs. Frequency (LMV1036-06)**

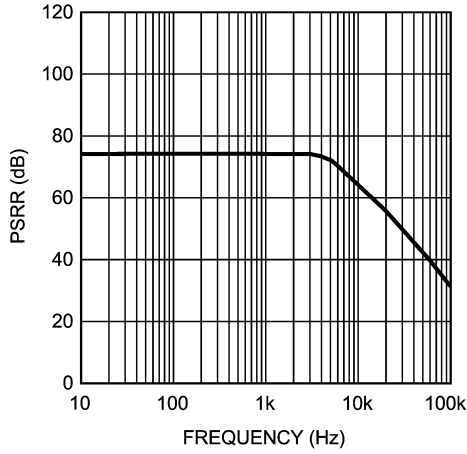

20084206

**Power Supply Rejection Ratio vs. Frequency (LMV1032-15)**

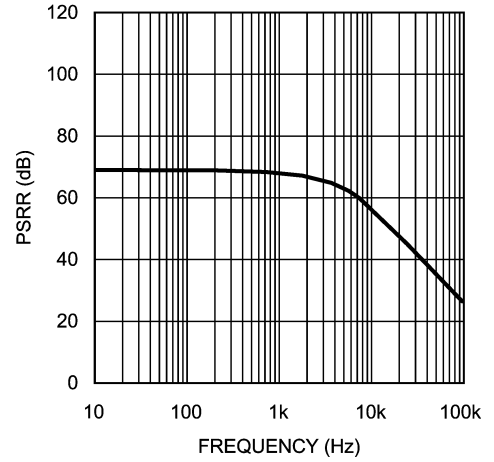

20084217

**Power Supply Rejection Ratio vs. Frequency (LMV1032-25)**

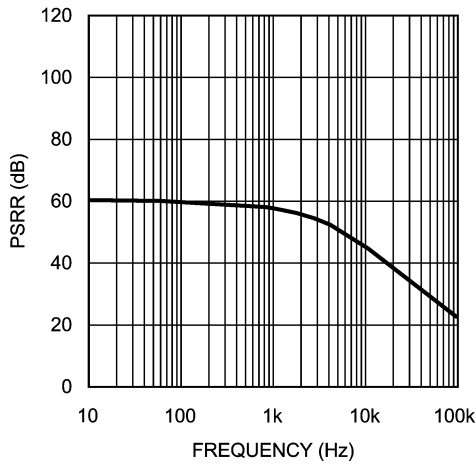

20084218

**Total Harmonic Distortion vs. Frequency (LMV1032-06)**

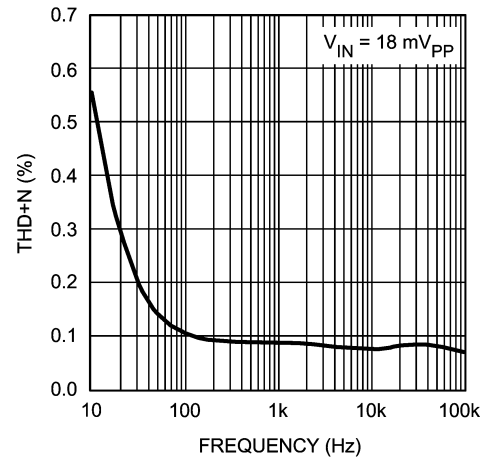

20084207

**Total Harmonic Distortion vs. Frequency (LMV1032-15)**

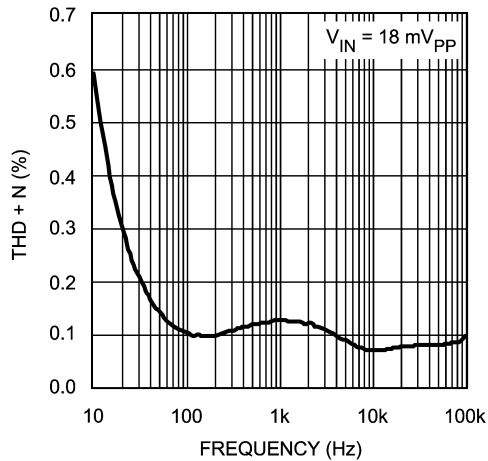

20084219

**Total Harmonic Distortion vs. Frequency (LMV1032-25)**

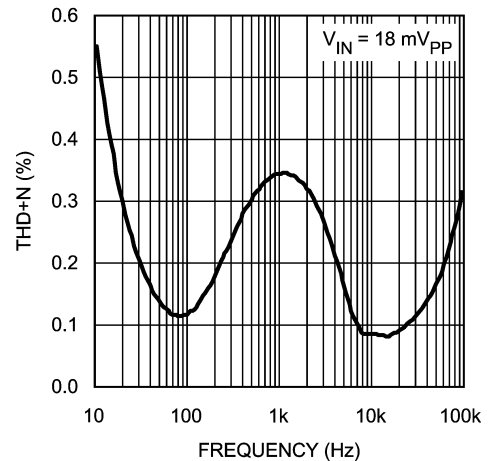

20084220

**Typical Performance Characteristics** Unless otherwise specified,  $V_S = 1.7V$ , single supply,  $T_A = 25^\circ C$  (Continued)

**Total Harmonic Distortion vs. Input Voltage (LMV1032-06)**

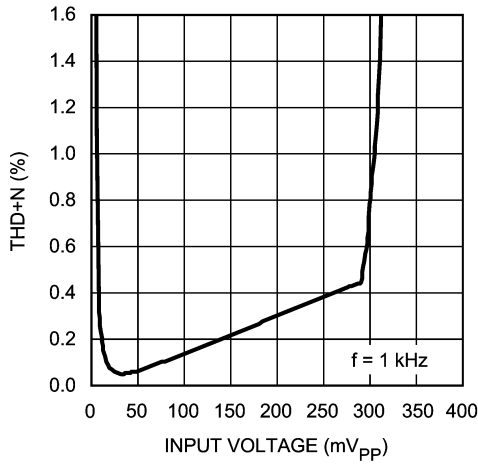

**Total Harmonic Distortion vs. Input Voltage (LMV1032-15)**

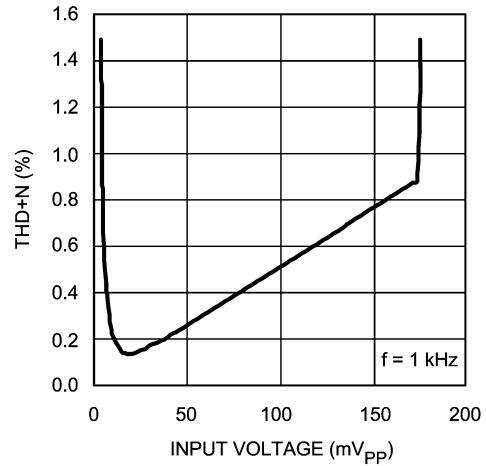

**Total Harmonic Distortion vs. Input Voltage (LMV1032-25)**

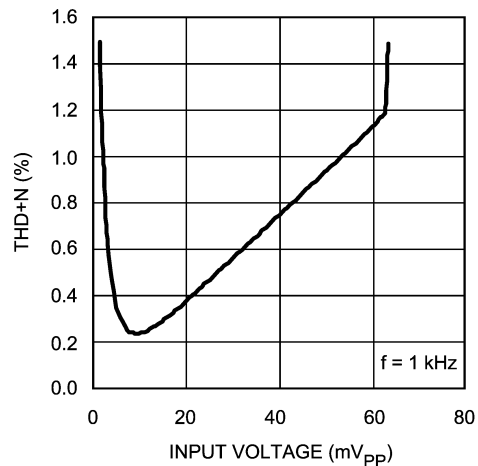

**Output Voltage Noise vs. Frequency (LMV1032-06)**

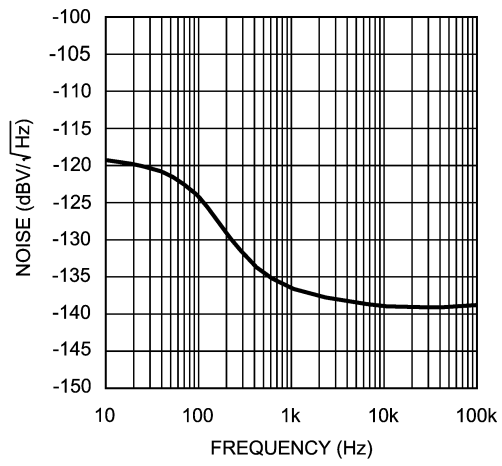

**Output Voltage Noise vs. Frequency (LMV1032-15)**

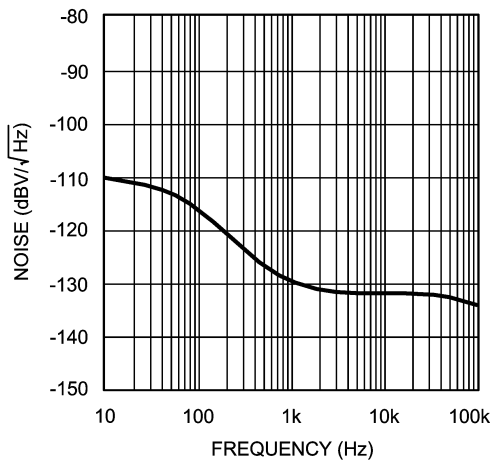

**Output Voltage Noise vs. Frequency (LMV1032-25)**

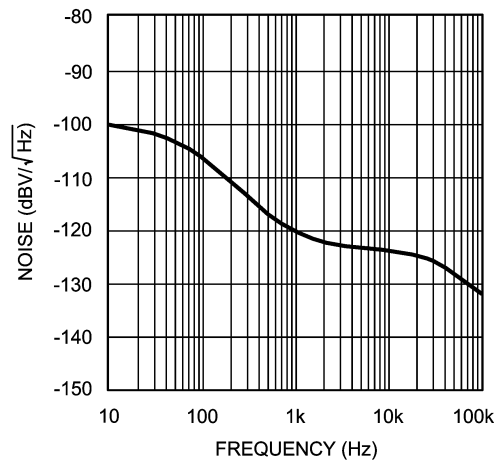

## Application Section

### LOW CURRENT

The LMV1032 has low supply current for a longer battery life. The low supply current makes this amplifier suitable for microphone applications which need to be always on.

### BUILT IN GAIN

The LMV1032 is offered in space saving small micro SMD package in order to fit in the metal can of a microphone. The LMV1032 is placed on the PCB inside the microphone.

The bottom side of the PCB has the pins that connect the supply voltage to the amplifier and make the output available. The input of the amplifier is connected inside the metal can via the PCB to the microphone.

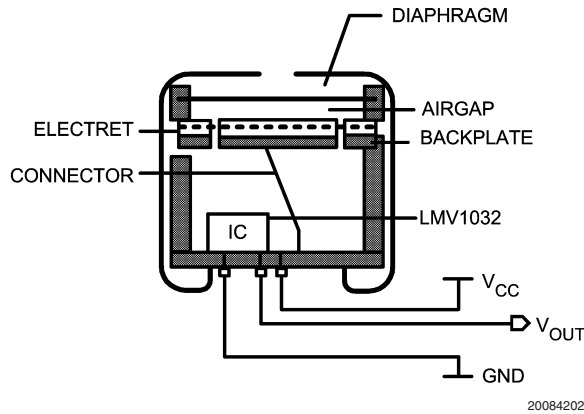
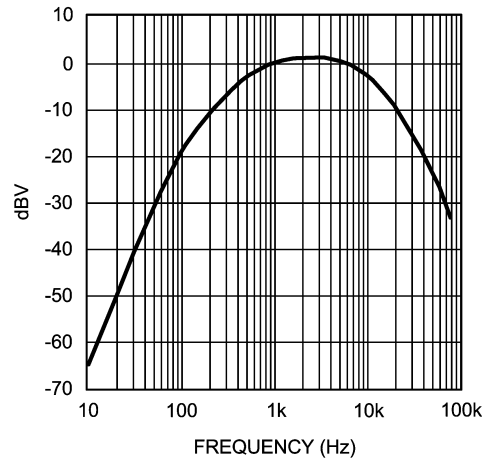

FIGURE 1. Built-in Gain

### A-WEIGHTED FILTER

The human ear has a frequency range from 20 Hz to about 20 kHz. Within this range the sensitivity of the human ear is not equal for each frequency. To approach the hearing response weighting filters are introduced. One of those filters is the A-weighted filter.

The A-weighted filter is usually used in signal to noise ratio measurements, where sound is compared to device noise. It improves the correlation of the measured data to the signal to noise ratio perceived by the human ear.



20084209

FIGURE 2. A-Weighted Filter

### MEASURING NOISE AND SNR

The overall noise of the LMV1032 is measured within the frequency band from 10 Hz to 22 kHz using an A-weighted filter. The input of the LMV1032 is connected to ground with a 5 pF capacitor.

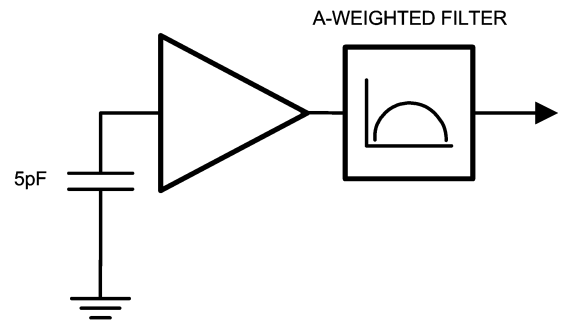

20084210

FIGURE 3. Noise Measurement Setup

Signal to noise ratio (SNR) is measured with a 1 kHz input signal of 18 mV<sub>PP</sub> using an A-weighted filter. This represents a sound pressure level of 94 dB SPL. No input capacitor is connected.

### SOUND PRESSURE LEVEL

The volume of sound applied to a microphone is usually stated as a pressure level referred to the threshold of hearing of the human ear. The sound pressure level (SPL) in decibels is defined by:

$$\text{Sound pressure level (dB)} = 20 \log P_m/P_O$$

Where,

$P_m$  is the measured sound pressure

$P_O$  is the threshold of hearing (20μPa)

In order to be able to calculate the resulting output voltage of the microphone for a given SPL, the sound pressure in dB SPL needs to be converted to the absolute sound pressure in dBPa. This is the sound pressure level in decibels referred to 1 Pascal (Pa).



## Application Section (Continued)

The conversion is given by:

$$\text{dBPa} = \text{dB SPL} + 20 \cdot \log 20 \mu\text{Pa}$$

$$\text{dBPa} = \text{dB SPL} - 94 \text{ dB}$$

Translation from absolute sound pressure level to a voltage is specified by the sensitivity of the microphone. A conventional microphone has a sensitivity of  $-44 \text{ dBV/Pa}$ .

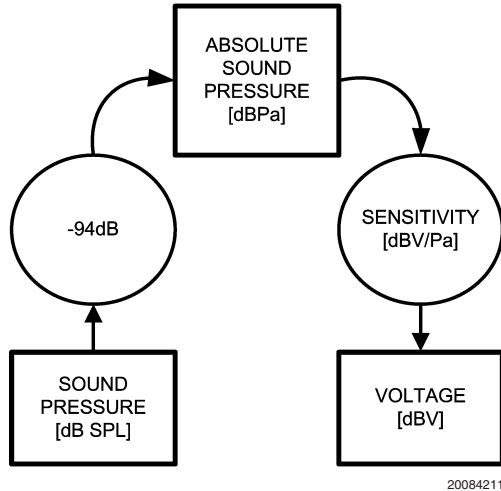

**FIGURE 4. dB SPL to dBV Conversion**

Example: Busy traffic is 70 dB SPL

$$V_{\text{OUT}} = 70 - 94 - 44 = -68 \text{ dBV}$$

This is equivalent to 1.13 mV<sub>PP</sub>

Since the LMV1032-06 has a gain of 2 (6 dB) over the JFET, the output voltage of the microphone is 2.26 mV<sub>PP</sub>. By implementing the LMV1032-06, the sensitivity of the microphone is  $-38 \text{ dBV/Pa}$  ( $-44 + 6$ ).

### LOW FREQUENCY CUT OFF FILTER

To reduce noise on the output of the microphone a low cut filter has been implemented. This filter reduces the effect of wind and handling noise.

It's also helpful to reduce the proximity effect in directional microphones. This effect occurs when the sound source is very close to the microphone. The lower frequencies are amplified which gives a bass sound. This amplification can cause an overload, which results in a distortion of the signal.

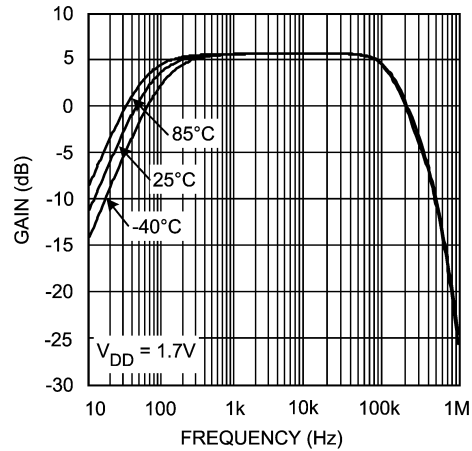

**FIGURE 5. Gain vs. Frequency Over Temperature**

The LMV1032 is optimized to be used in audio band applications. By using the LMV1032, the gain response is flat within the audio band and has the linearity and temperature stability.

### ADVANTAGE OF THREE PINS

The LMV1032 ECM solution has three pins instead of two pins as in the case of a JFET solution. The third pin provides the advantage of a low supply current, high PSRR and eliminates the need for additional components.

Noise pick-up by a microphone in a cell phone is a well-known problem. A conventional JFET circuit is sensitive for noise pick-up because of its high output impedance. The output impedance is usually around 2.2 kΩ. By providing separate output and supply pins a much lower output impedance is achieved and therefore is less sensitive to noise pick-up.

RF noise is amongst other caused by non-linear behavior. The non-linear behavior of the amplifier at high frequencies, well above the usable bandwidth of the device, causes AM-demodulation of high frequency signals. The AM modulation contained in such signals folds back into the audio band, thereby disturbing the intended microphone signal. The GSM signal of a cell phone is such an AM-modulated signal. The modulation frequency of 216 Hz and its harmonics can be observed in the audio band. This type of noise is called bumblebee noise.

### EXTERNAL PRE-AMPLIFIER APPLICATION

The LMV1032 can also be used outside of an ECM as a space saving external pre-amplifier. In this application, the LMV1032 follows a phantom biased JFET microphone in the circuit (Figure 6). The input of the LMV1032 is connected to the microphone via the 2.2 μF capacitor. The advantage of this circuit versus one with only a JFET microphone are the additional gain and the high pass filter of the LMV1032. The high pass filter makes the output signal more robust and less sensitive to low frequency disturbances. The LMV1032 should be placed as close as possible to the microphone.

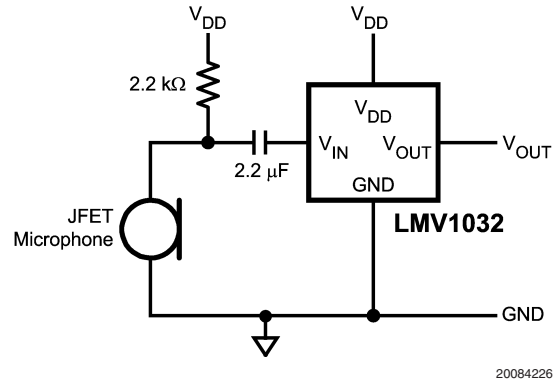
**Application Section** (Continued)**FIGURE 6. LMV1032 as external pre-amplifier**

# Physical Dimensions inches (millimeters)

unless otherwise noted

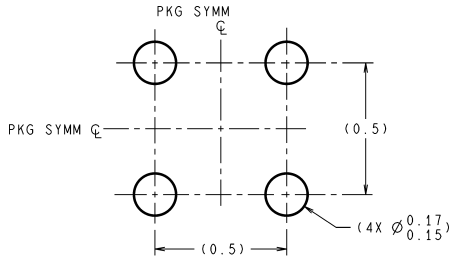

DIMENSIONS ARE IN MILLIMETERS

## LAND PATTERN RECOMMENDATION

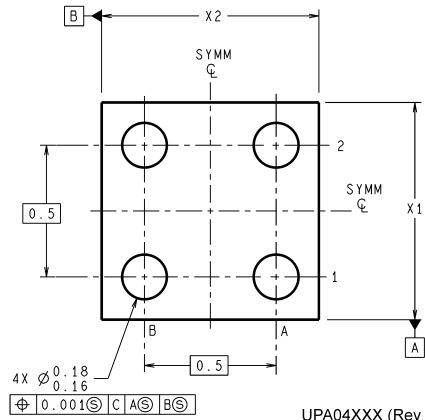
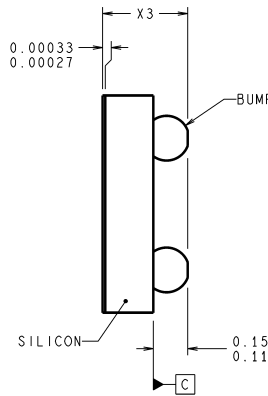
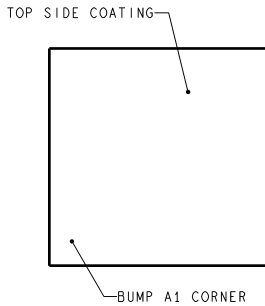

NOTE: UNLESS OTHERWISE SPECIFIED.

1. TITANIUM COATING.
2. FOR SOLDER BUMP COMPOSITION, SEE "SOLDER INFORMATION" IN THE PACKAGING SECTION OF THE NATIONAL SEMICONDUCTOR WEB PAGE ([www.national.com](http://www.national.com)).
3. RECOMMEND NON-SOLDER MASK DEFINED LANDING PAD.
4. PIN A1 IS ESTABLISHED BY LOWER LEFT CORNER WITH RESPECT TO TEXT ORIENTATION.
5. XXX IN DRAWING NUMBER REPRESENTS PACKAGE SIZE VARIATION WHERE X1 IS PACKAGE WIDTH, X2 IS PACKAGE LENGTH AND X3 IS PACKAGE HEIGHT.
6. REFERENCE JEDEC REGISTRATION MO-211. VARIATION BC.

**4-Bump Ultra Thin micro SMD**  
**NS Package Number UPA04QQA**  
**X1 = 1.133mm X2 = 1.133mm X3 = 0.4mm**

## Notes

National does not assume any responsibility for use of any circuitry described, no circuit patent licenses are implied and National reserves the right at any time without notice to change said circuitry and specifications.

For the most current product information visit us at [www.national.com](http://www.national.com).

### LIFE SUPPORT POLICY

NATIONAL'S PRODUCTS ARE NOT AUTHORIZED FOR USE AS CRITICAL COMPONENTS IN LIFE SUPPORT DEVICES OR SYSTEMS WITHOUT THE EXPRESS WRITTEN APPROVAL OF THE PRESIDENT AND GENERAL COUNSEL OF NATIONAL SEMICONDUCTOR CORPORATION. As used herein:

1. Life support devices or systems are devices or systems which, (a) are intended for surgical implant into the body, or (b) support or sustain life, and whose failure to perform when properly used in accordance with instructions for use provided in the labeling, can be reasonably expected to result in a significant injury to the user.
2. A critical component is any component of a life support device or system whose failure to perform can be reasonably expected to cause the failure of the life support device or system, or to affect its safety or effectiveness.

### BANNED SUBSTANCE COMPLIANCE

National Semiconductor manufactures products and uses packing materials that meet the provisions of the Customer Products Stewardship Specification (CSP-9-111C2) and the Banned Substances and Materials of Interest Specification (CSP-9-111S2) and contain no "Banned Substances" as defined in CSP-9-111S2.



**National Semiconductor**  
Americas Customer  
Support Center  
Email: [new.feedback@nsc.com](mailto:new.feedback@nsc.com)  
Tel: 1-800-272-9959

[www.national.com](http://www.national.com)

**National Semiconductor**  
Europe Customer Support Center  
Fax: +49 (0) 180-530 85 86  
Email: [europa.support@nsc.com](mailto:europa.support@nsc.com)  
Deutsch Tel: +49 (0) 69 9508 6208  
English Tel: +44 (0) 870 24 0 2171  
Français Tel: +33 (0) 1 41 91 8790

**National Semiconductor**  
Asia Pacific Customer  
Support Center  
Email: [ap.support@nsc.com](mailto:ap.support@nsc.com)

**National Semiconductor**  
Japan Customer Support Center  
Fax: 81-3-5639-7507  
Email: [jpn.feedback@nsc.com](mailto:jpn.feedback@nsc.com)  
Tel: 81-3-5639-7560