

# Notice for TAIYO YUDEN products

Please read this notice before using the TAIYO YUDEN products.

## REMINDERS

- Product information in this catalog is as of October 2009. All of the contents specified herein are subject to change without notice due to technical improvements, etc. Therefore, please check for the latest information carefully before practical application or usage of the Products.

Please note that Taiyo Yuden Co., Ltd. shall not be responsible for any defects in products or equipment incorporating such products, which are caused under the conditions other than those specified in this catalog or individual specification.

- Please contact Taiyo Yuden Co., Ltd. for further details of product specifications as the individual specification is available.
- Please conduct validation and verification of products in actual condition of mounting and operating environment before commercial shipment of the equipment.
- All electronic components or functional modules listed in this catalog are developed, designed and intended for use in general electronics equipment.(for AV, office automation, household, office supply, information service, telecommunications, (such as mobile phone or PC) etc.). Before incorporating the components or devices into any equipment in the field such as transportation,( automotive control, train control, ship control), transportation signal, disaster prevention, medical, public information network (telephone exchange, base station) etc. which may have direct influence to harm or injure a human body, please contact Taiyo Yuden Co., Ltd. for more detail in advance. Do not incorporate the products into any equipment in fields such as aerospace, aviation, nuclear control, submarine system, military, etc. where higher safety and reliability are especially required.

In addition, even electronic components or functional modules that are used for the general electronic equipment, if the equipment or the electric circuit require high safety or reliability function or performances, a sufficient reliability evaluation check for safety shall be performed before commercial shipment and moreover, due consideration to install a protective circuit is strongly recommended at customer's design stage.

- The contents of this catalog are applicable to the products which are purchased from our sales offices or distributors (so called "TAIYO YUDEN' s official sales channel"). It is only applicable to the products purchased from any of TAIYO YUDEN' s official sales channel.
- Please note that Taiyo Yuden Co., Ltd. shall have no responsibility for any controversies or disputes that may occur in connection with a third party's intellectual property rights and other related rights arising from your usage of products in this catalog. Taiyo Yuden Co., Ltd. grants no license for such rights.
- Caution for export**  
Certain items in this catalog may require specific procedures for export according to "Foreign Exchange and Foreign Trade Control Law" of Japan, "U.S. Export Administration Regulations", and other applicable regulations. Should you have any question or inquiry on this matter, please contact our sales staff.  
Should you have any question or inquiry on this matter, please contact our sales staff.

# HIGH VALUE MULTILAYER CERAMIC CAPACITORS



WAVE REFLOW

## FEATURES

- The use of nickel as electrode material and plating processing improve the solderability and heat resistance characteristics. It also prevents migration and raises the level of reliability.
- Low equivalent series resistance(ESR) provides superior noise absorption characteristics.
- Compared to tantalum or aluminum electrolytic capacitors, multilayer ceramic capacitors offer a number of superior features, including: Higher permissible ripple current values  
Smaller case sizes with high rated voltage  
Improved reliability due to higher insulation resistance and breakdown voltage.

## APPLICATIONS

- General digital circuit
- Power supply bypass capacitors  
Liquid crystal modules  
Liquid crystal drive voltage lines  
LSI, IC, converters(both for input and output)
- Smoothing capacitors  
DC-DC converters (for both input and output)  
Switching power supplies (secondary side)

## ORDERING CODE

J M K 3 1 6 B J 1 0 6 M L - T  $\triangle$

**1 Rated voltage (VDC)**

A	4
J	6.3
L	10
E	16
T	25
G	35
U	50

**2 Series name**

M Multilayer ceramic capacitor

**3 End termination**

K Plated

**4 Dimensions (EIA) L×W (mm)**

107(0603)	1.6×0.8
212(0805)	2.0×1.25
316(1206)	3.2×1.6
325(1210)	3.2×2.5

**5 Temperature characteristics code**

BJ	B
	X5R
B7	X7R
$\triangle$ F	F
	Y5V

$\triangle$ =Blank space

**6 Nominal capacitance (pF)**

example	
473	47,000
105	1,000,000

**7 Capacitance tolerance**

K	±10%
M	±20%
Z	+80% -20%

**8 Thickness (mm)**

K	0.45
A	0.8
D	0.85
G	1.25
L	1.6
N	1.9
Y	2.0max
M	2.5

**9 Special code**

- Standard product

**10 Internal code**

$\triangle$	Standard product
$\triangle$	Blank space

**11 Packaging**

T	$\phi$ 178mm Taping (4mm pitch) All types
P	$\phi$ 178mm Taping (4mm pitch, 1000pcs/reel) 1210Type Thickness : M

## EXTERNAL DIMENSIONS/STANDARD QUANTITY

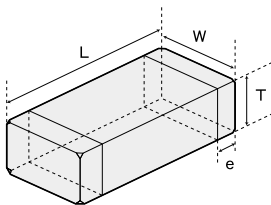

Type (EIA)	L	W	T	e	Standard quantity [pcs]	
					Paper tape	Embossed tape
□MK107 (0603)	1.6±0.10 <sup>-3,4</sup> (0.063±0.004)	0.8±0.10 <sup>-3,4</sup> (0.031±0.004)	0.45±0.05(0.018±0.002)	K	0.35±0.25 (0.014±0.010)	4000
			0.8±0.10 <sup>-3,4</sup> (0.031±0.004)	A		
□MK212 (0805)	2.0±0.10 <sup>-1,3</sup> (0.079±0.004)	1.25±0.10 <sup>-1,3</sup> (0.049±0.004)	0.45±0.05(0.018±0.002)	K	0.5±0.25 (0.020±0.010)	4000
			0.85±0.10(0.033±0.004)	D		
			1.25±0.10 <sup>-1,3</sup> (0.049±0.004)	G		
□MK316 (1206)	3.2±0.15 <sup>-3</sup> (0.126±0.006)	1.6±0.15 <sup>-3</sup> (0.063±0.006)	0.85±0.10(0.033±0.004)	D	0.5 <sup>+0.35</sup> <sub>-0.25</sub> (0.020±0.014)	4000
			1.25±0.10(0.049±0.004)	G		
			1.6±0.20(0.063±0.008)	L		
			0.85±0.10(0.033±0.004)	D		
□MK325 (1210)	3.2±0.30 (0.126±0.012)	2.5±0.20 <sup>-2</sup> (0.098±0.008)	1.9±0.20(0.075±0.008)	N	0.6±0.3 (0.024±0.012)	2000
			1.9 <sup>+0.1</sup> <sub>-0.2</sub> (0.075 <sup>+0.004</sup> <sub>-0.008</sub> )	Y		
			2.5±0.20 <sup>-2</sup> (0.098±0.008)	M		

- Note:
- \*1. Including dimension tolerance±0.15mm (±0.006 inch).
  - \*2. Including dimension tolerance±0.3mm (±0.012 inch).
  - \*3. Including dimension tolerance±0.2mm (±0.008 inch).
  - \*4. Including dimension tolerance±0.15/-0.1mm (+0.006/-0.004 inch).

Unit : mm (inch)

## AVAILABLE CAPACITANCE RANGE

Type	TC	107				212				316				325												
		X7R	B/X5R	X5R	F/Y5V	X7R	B/X5R	X5R	F/Y5V	X7R	B/X5R	X5R	F/Y5V	X7R	B/X5R	X5R	F/Y5V									
Cap	VDC	16	10	6.3	3.5	2.5	1.6	1.0	0.63	50	25	16	10	6.3	4	50	25	16	10	6.3	4	3.5	2.5	1.6	1.0	0.63
L [pF]	[3 digits]																									
0.1	104																									
0.15	154																									
0.22	224	A	A	A	A	A																				
0.33	334																									
0.47	474	A	A	A	A	A																				
0.68	684	A	A	A	A	A	A																			
1	105	A	A	A	A	A	A	A		G	G	G	G													
2.2	225																									
3.3	335																									
4.7	475																									
6.8	685																									
10	106																									
22	226																									
47	476																									
100	107																									

Note : Letters in the table indicate thickness.

\* This catalog contains the typical specification only due to the limitation of space. When you consider purchase of our products, please check our specification. For details of each product (characteristics graph, reliability information, precautions for use, and so on), see our Web site (<http://www.ty-top.com/>) or CD catalogs.

● Low Profile Multilayer Ceramic Capacitors

Type	107						212						316						325													
	TC	B/X5R	X5R	X7R	B/X5R	X5R	F/Y5V	B/X5R	X5R	F/Y5V	B/X5R	X5R	F/Y5V	B/X5R	X5R	F/Y5V	B/X5R															
Cap. [μF]	10	6.3	25	16	10	6.3	16	10	25	16	10	6.3	50	10	6.3	50	25	16	10	6.3	25	16	10	6.3	50	35	10	6.3	25	16	10	
3[digits]																																
0.1	104																															
0.22	224																															
0.33	334																															
0.47	474																															
0.68	684																															
1	105	K	K	K	K																											
2.2	225																															
3.3	335																															
4.7	475																															
6.8	685																															
10	106																															
22	226																															
47	476																															

Note : Letters in the table indicate thickness.

■ PART NUMBERS

● 107TYPE

[Temp.char. BJ:B/X5R]

Rated Voltage	Ordering code	EHS (Environmental Hazardous Substances)	Capacitance [μF]	Temperature characteristics	Dissipation factor [%] Max.	Soldering method R:Reflow soldering W:Wave soldering	Capacitance tolerance	Thickness (mm)
50V	UMK107 BJ105□A <sup>1</sup>	RoHS	1	X5R	10			0.8±0.1
35V	GMK107 BJ105□A <sup>1</sup>	RoHS	1	B/X5R	5	R		0.8±0.1
	TMK107 BJ105□K <sup>1</sup>	RoHS	1	X5R	10			0.45±0.05
25V	TMK107 BJ224□A	RoHS	0.22	B/X5R	3.5	R/W		0.8±0.1
	TMK107 BJ474□A <sup>1</sup>	RoHS	0.47	B/X5R	3.5			0.8±0.1
	TMK107 BJ105□A <sup>1</sup>	RoHS	1	B/X5R	5	R		0.8±0.1
	EMK107 BJ105□K <sup>1</sup>	RoHS	1	X5R	10			0.45±0.05
16V	EMK107 BJ224□A	RoHS	0.22	B/X5R <sup>2</sup>	3.5	R/W		0.8±0.1
	EMK107 BJ474□A	RoHS	0.47	B/X5R <sup>2</sup>	3.5			0.8±0.1
	EMK107 BJ105□A <sup>1</sup>	RoHS	1	B/X5R <sup>2</sup>	5			0.8±0.1
	EMK107 BJ225□A <sup>1</sup>	RoHS	2.2	B/X5R	10			0.8±0.1
	LMK107 BJ105□K <sup>1</sup>	RoHS	1	B/X5R	10	R		0.45±0.05
	LMK107 BJ225□K <sup>1</sup>	RoHS	2.2	X5R	10			0.45±0.05
	LMK107 BJ475MK <sup>1,4</sup>	RoHS	4.7	X5R	10			0.45±0.05
10V	LMK107 BJ224□A	RoHS	0.22	B/X5R <sup>2</sup>	3.5	R/W		0.8±0.1
	LMK107 BJ474□A	RoHS	0.47	B/X5R <sup>2</sup>	3.5			0.8±0.1
	LMK107 BJ105□A <sup>1</sup>	RoHS	1	B/X5R <sup>2</sup>	5			0.8±0.1
	LMK107 BJ225□A <sup>1</sup>	RoHS	2.2	B/X5R	10			0.8±0.1
	LMK107 BJ475□A <sup>1</sup>	RoHS	4.7	X5R	10			0.8±0.1
	LMK107 BJ106MA <sup>1,4</sup>	RoHS	10	X5R	10			0.8±0.2
6.3V	JMK107 BJ105□K <sup>1</sup>	RoHS	1	B/X5R	10	R		0.45±0.05
	JMK107 BJ225□K <sup>1</sup>	RoHS	2.2	X5R	10			0.45±0.05
	JMK107 BJ475MK <sup>1</sup>	RoHS	4.7	X5R	10			0.45±0.05
	JMK107 BJ225□A <sup>1</sup>	RoHS	2.2	B/X5R	10			0.8±0.1
	JMK107 BJ475□A <sup>1</sup>	RoHS	4.7	X5R	10			0.8±0.1
	JMK107 BJ106MA <sup>1</sup>	RoHS	10	X5R	10			0.8+0.15/-0.1
4V	AMK107 BJ106MA <sup>1</sup>	RoHS	10	X5R	10			0.8±0.1
	AMK107 BJ226MA <sup>1,3</sup>	RoHS	22	X5R	10			0.8±0.2

[Temp.char. B7:X7R]

Rated Voltage	Ordering code	EHS (Environmental Hazardous Substances)	Capacitance [μF]	Temperature characteristics	Dissipation factor [%] Max.	Soldering method R:Reflow soldering W:Wave soldering	Capacitance tolerance	Thickness (mm)
16V	EMK107 B7 224□A <sup>1</sup>	RoHS	0.22	X7R	3.5	R/W		0.8±0.1
	EMK107 B7 474□A <sup>1</sup>	RoHS	0.47	X7R	3.5	R		0.8±0.1
	EMK107 B7 105□A <sup>1</sup>	RoHS	1	X7R	5			0.8±0.1
10V	LMK107 B7 224□A	RoHS	0.22	X7R	3.5	R/W		0.8±0.1
	LMK107 B7 474□A	RoHS	0.47	X7R	3.5			0.8±0.1
	LMK107 B7 105□A <sup>1</sup>	RoHS	1	X7R	5	R		0.8±0.1
6.3V	JMK107 B7 224□A	RoHS	0.22	X7R	3.5	R/W		0.8±0.1
	JMK107 B7 474□A	RoHS	0.47	X7R	3.5			0.8±0.1
	JMK107 B7 105□A <sup>1</sup>	RoHS	1	X7R	5	R		0.8±0.1

[Temp.char. F:F/Y5V]

Rated Voltage	Ordering code	EHS (Environmental Hazardous Substances)	Capacitance [μF]	Temperature characteristics	Dissipation factor [%] Max.	Soldering method R:Reflow soldering W:Wave soldering	Capacitance tolerance	Thickness (mm)
50V	UMK107 F104ZA	RoHS	0.1	F/Y5V	7			0.8±0.1
25V	TMK107 F474ZA	RoHS	0.47	F/Y5V	7	R/W		0.8±0.1
	EMK107 F224ZA	RoHS	0.22	F/Y5V	7			0.8±0.1
16V	EMK107 F474ZA	RoHS	0.47	F/Y5V	7			0.8±0.1
	EMK107 F105ZA	RoHS	1	F/Y5V	16			0.8±0.1
	EMK107 F225ZA	RoHS	2.2	F/Y5V	16	R		0.8±0.1
10V	LMK107 F105ZA	RoHS	1	F/Y5V	16			0.8±0.1
	LMK107 F225ZA	RoHS	2.2	F/Y5V	16			0.8±0.1

□ Please specify the capacitance tolerance code. \*1 1.5 times the rated voltage is applied to the chip during the high temperature loading test. \*2 We may provide X7R for some items according to the individual specification. \*3 The exchange of individual specification is necessary depending on the application and circuit condition. Please contact Taiyo Yuden sales channels. \*4 "D" is used for the internal code.

\* This catalog contains the typical specification only due to the limitation of space. When you consider purchase of our products, please check our specification. For details of each product (characteristics graph, reliability information, precautions for use, and so on), see our Web site (<http://www.ty-top.com/>) or CD catalogs.

**PART NUMBERS**

**● 212TYPE**

[Temp.char. B: B/X5R]

Rated Voltage	Ordering code	EHS (Environmental Hazardous Substances)	Capacitance [ $\mu$ F]	Temperature characteristics	Dissipation factor (%) Max.	Soldering method R:Reflow soldering W:Wave soldering	Capacitance tolerance	Thickness (mm)
50V	UMK212 BJ104□G	RoHS	0.1	B/X5R <sup>+2</sup>	3.5	R/W	±10%	1.25±0.1
	UMK212 BJ224□G <sup>*1</sup>	RoHS	0.22	B/X5R <sup>+2</sup>	3.5			1.25±0.1
	UMK212 BJ474□G <sup>*1</sup>	RoHS	0.47	B/X5R <sup>+2</sup>	3.5			1.25±0.1
	UMK212 BJ105□G <sup>*1</sup>	RoHS	1	X5R	5			1.25±0.1
25V	TMK212 BJ474□D	RoHS	0.47	B/X5R	3.5	R	±10%	0.85±0.1
	TMK212 BJ105□D	RoHS	1	B/X5R	5			0.85±0.1
	TMK212 BJ225□D <sup>*1</sup>	RoHS	2.2	B/X5R	5			0.85±0.1
	TMK212 BJ475□D <sup>*1+4</sup>	RoHS	4.7	X5R	10			0.85±0.1
	TMK212 BJ225□G <sup>*1</sup>	RoHS	2.2	B/X5R	5			1.25±0.1
	TMK212 BJ475□G <sup>*1</sup>	RoHS	4.7	X5R	10			1.25±0.15
	EMK212 BJ105□D	RoHS	1	B/X5R <sup>+2</sup>	5			0.85±0.1
16V	EMK212 BJ225□D	RoHS	2.2	B/X5R <sup>+2</sup>	5	R	±20%	0.85±0.1
	EMK212 BJ475□D <sup>*1</sup>	RoHS	4.7	B/X5R	10			0.85±0.1
	EMK212 BJ106□D <sup>*1+4</sup>	RoHS	10	X5R	10			0.85±0.1
	EMK212 BJ225□G	RoHS	2.2	B/X5R <sup>+2</sup>	5			1.25±0.1
	EMK212 BJ475□G <sup>*1</sup>	RoHS	4.7	B/X5R <sup>+2</sup>	5			1.25±0.15
	EMK212 BJ106□G <sup>*1</sup>	RoHS	10	X5R	10			1.25±0.15
	EMK212 BJ226MG <sup>*1</sup>	RoHS	22	X5R	10			1.25±0.2
10V	LМК212 BJ475□K <sup>*1</sup>	RoHS	4.7	X5R	10	R	±20%	0.45±0.05
	LМК212 BJ105□D	RoHS	1	B/X5R <sup>+2</sup>	3.5			0.85±0.1
	LМК212 BJ225□D	RoHS	2.2	B/X5R <sup>+2</sup>	5			0.85±0.1
	LМК212 BJ475□D	RoHS	4.7	B/X5R	10			0.85±0.1
	LМК212 BJ106□D <sup>*1</sup>	RoHS	10	X5R	10			0.85±0.1
	LМК212 BJ225□G	RoHS	2.2	B/X5R <sup>+2</sup>	5			1.25±0.1
	LМК212 BJ475□G	RoHS	4.7	B/X5R <sup>+2</sup>	5			1.25±0.15
	LМК212 BJ106□G	RoHS	10	X5R	10			1.25±0.15
	LМК212 BJ226MG <sup>*1</sup>	RoHS	22	X5R	10			1.25±0.15
	LМК212 BJ226MG <sup>*1</sup>	RoHS	22	X5R	10			1.25±0.15
	LМК212 BJ226MG <sup>*1</sup>	RoHS	22	X5R	10			1.25±0.15
	LМК212 BJ226MG <sup>*1</sup>	RoHS	22	X5R	10			1.25±0.15
	LМК212 BJ226MG <sup>*1</sup>	RoHS	22	X5R	10			1.25±0.15
6.3V	JMK212 BJ475□K <sup>*1</sup>	RoHS	4.7	X5R	10	R	±20%	0.45±0.05
	JMK212 BJ106MK <sup>*1</sup>	RoHS	10	X5R	10			0.45±0.05
	JMK212 BJ475□D	RoHS	4.7	X5R	10			0.85±0.1
	JMK212 BJ106□D	RoHS	10	X5R	10			0.85±0.1
	JMK212 BJ226MD <sup>*1</sup>	RoHS	22	X5R	10			0.85±0.1
	JMK212 BJ475□G	RoHS	4.7	B/X5R	5			1.25±0.15
	JMK212 BJ106□G	RoHS	10	X5R <sup>+2</sup>	10			1.25±0.15
	JMK212 BJ226MG <sup>*1</sup>	RoHS	22	X5R	10			1.25±0.15
	JMK212 BJ226MG <sup>*1</sup>	RoHS	22	X5R	10			1.25±0.15
	JMK212 BJ226MG <sup>*1</sup>	RoHS	22	X5R	10			1.25±0.15

[Temp.char. B7: X7R]

Rated Voltage	Ordering code	EHS (Environmental Hazardous Substances)	Capacitance [ $\mu$ F]	Temperature characteristics	Dissipation factor (%) Max.	Soldering method R:Reflow soldering W:Wave soldering	Capacitance tolerance	Thickness (mm)
50V	UMK212 B7 104□G	RoHS	0.1	X7R	3.5	R/W	±10%	1.25±0.1
	UMK212 B7 224□G <sup>*1</sup>	RoHS	0.22	X7R	3.5			1.25±0.1
	UMK212 B7 474□G <sup>*1</sup>	RoHS	0.47	X7R	3.5			1.25±0.1
35V	GМК212 B7 105□G <sup>*1</sup>	RoHS	1	X7R	3.5	R/W	±10%	1.25±0.1
25V	TMK212 B7 105□G <sup>*1</sup>	RoHS	1	X7R	5	R	±20%	1.25±0.1
	EMK212 B7 474□D	RoHS	0.47	X7R	3.5			0.85±0.1
	EMK212 B7 105□D	RoHS	1	X7R	5			0.85±0.1
	EMK212 B7 225□D <sup>*1</sup>	RoHS	2.2	X7R	5			0.85±0.1
	EMK212 B7 105□G	RoHS	1	X7R	3.5			1.25±0.1
	EMK212 B7 225□G <sup>*1</sup>	RoHS	2.2	X7R	10			1.25±0.1
16V	EMK212 B7 475□G <sup>*1</sup>	RoHS	4.7	X7R	10	R	±20%	1.25±0.1
	LМК212 B7 105□D	RoHS	1	X7R	3.5			0.85±0.1
	LМК212 B7 225□D	RoHS	2.2	X7R	5			0.85±0.1
	LМК212 B7 105□G	RoHS	1	X7R	3.5			1.25±0.1
	LМК212 B7 225□G	RoHS	2.2	X7R	5			1.25±0.1
	LМК212 B7 475□G <sup>*1</sup>	RoHS	4.7	X7R	10			1.25±0.1
	LМК212 B7 475□G <sup>*1</sup>	RoHS	4.7	X7R	10			1.25±0.1
10V	LМК212 B7 105□D	RoHS	1	X7R	3.5	R/W	±20%	1.25±0.1
	LМК212 B7 225□D	RoHS	2.2	X7R	5			0.85±0.1
	LМК212 B7 105□G	RoHS	1	X7R	3.5			1.25±0.1
	LМК212 B7 225□G	RoHS	2.2	X7R	5			1.25±0.1
6.3V	LМК212 B7 475□G <sup>*1</sup>	RoHS	4.7	X7R	10	R/W	±20%	1.25±0.1
	JMK212 B7 106□G <sup>*1</sup>	RoHS	10	X7R	10	R	±20%	1.25±0.15

[Temp.char. F: F/Y5V]

Rated Voltage	Ordering code	EHS (Environmental Hazardous Substances)	Capacitance [ $\mu$ F]	Temperature characteristics	Dissipation factor (%) Max.	Soldering method R:Reflow soldering W:Wave soldering	Capacitance tolerance	Thickness (mm)
50V	UMK212 F224ZD	RoHS	0.22	F/Y5V	7	R/W	+80% -20%	0.85±0.1
	UMK212 F474ZG	RoHS	0.47	F/Y5V	7			1.25±0.1
	UMK212 F105ZG	RoHS	1	F/Y5V	7			1.25±0.1
16V	EMK212 F225ZG	RoHS	2.2	F/Y5V	7	R	+80% -20%	1.25±0.1
	LМК212 F225ZD	RoHS	2.2	F/Y5V	9			0.85±0.1
10V	LМК212 F475ZG	RoHS	4.7	F/Y5V	9	R	+80% -20%	1.25±0.1
	LМК212 F106ZG	RoHS	10	F/Y5V	16			1.25±0.1
6.3V	JMK212 F475ZD	RoHS	4.7	F/Y5V	16	R	+80% -20%	0.85±0.1
	JMK212 F106ZG	RoHS	10	F/Y5V	16			1.25±0.1

□ Please specify the capacitance tolerance code. \*1 1.5 times the rated voltage is applied to the chip during the high temperature loading test. \*2 We may provide X7R for some items according to the individual specification. \*4 "D" is used for the internal code.

\* This catalog contains the typical specification only due to the limitation of space. When you consider purchase of our products, please check our specification. For details of each product (characteristics graph, reliability information, precautions for use, and so on), see our Web site (<http://www.ty-top.com/>) or CD catalogs.

**PART NUMBERS**

**316TYPE**

[Temp.char. BJ:B/X5R]

Rated Voltage	Ordering code	EHS (Environmental Hazardous Substances)	Capacitance [ $\mu$ F]	Temperature characteristics	Dissipation factor (%) Max.	Soldering method R:Reflow soldering W:Wave soldering	Capacitance tolerance	Thickness [mm]				
50V	UMK316 BJ105□D <sup>*1</sup>	RoHS	1	B/X5R	3.5	R	±10% ±20%	0.85±0.1				
	UMK316 BJ225□D <sup>*1</sup>	RoHS	2.2	B/X5R	3.5			0.85±0.1				
	UMK316 BJ105□L	RoHS	1	B/X5R <sup>*2</sup>	3.5			1.6±0.2				
	UMK316 BJ475□L <sup>*1</sup>	RoHS	4.7	X5R	10			1.6±0.2				
25V	TMK316 BJ105□D	RoHS	1	B/X5R	3.5			R/W	±10% ±20%	0.85±0.1		
	TMK316 BJ225□D <sup>*1</sup>	RoHS	2.2	B/X5R	3.5					0.85±0.1		
	TMK316 BJ475□D <sup>*1</sup>	RoHS	4.7	X5R	5					0.85±0.1		
	TMK316 BJ106□D <sup>*1</sup>	RoHS	10	X5R	10					0.85±0.1		
	TMK316 BJ225□L	RoHS	2.2	B/X5R <sup>*2</sup>	3.5					1.6±0.2		
	TMK316 BJ475□L <sup>*1</sup>	RoHS	4.7	B/X5R	5					1.6±0.2		
	TMK316 BJ106□L <sup>*1</sup>	RoHS	10	X5R <sup>*2</sup>	5					1.6±0.2		
	EMK316 BJ225□D	RoHS	2.2	B/X5R	3.5					0.85±0.1		
16V	EMK316 BJ475□D	RoHS	4.7	X5R	5	R	±20%			0.85±0.1		
	EMK316 BJ106□D <sup>*1</sup>	RoHS	10	X5R	10					0.85±0.1		
	EMK316 BJ225□L	RoHS	2.2	B/X5R <sup>*2</sup>	3.5					1.6±0.2		
	EMK316 BJ475□L	RoHS	4.7	B/X5R	5					1.6±0.2		
	EMK316 BJ106□L <sup>*1</sup>	RoHS	10	B/X5R <sup>*2</sup>	5					1.6±0.2		
	EMK316 BJ226ML <sup>*1</sup>	RoHS	22	B/X5R	10					±20%	1.6±0.2	
10V	LМК316 BJ475□D	RoHS	4.7	B/X5R	5					R	±10% ±20%	0.85±0.1
	LМК316 BJ106□D	RoHS	10	B/X5R	10							0.85±0.1
	LМК316 BJ226MD <sup>*1</sup>	RoHS	22	X5R	10			±20%	0.85±0.1			
	LМК316 BJ106□L	RoHS	10	B/X5R <sup>*2</sup>	5			±10% ±20%	1.6±0.2			
	LМК316 BJ226ML <sup>*1</sup>	RoHS	22	B/X5R	10			±20%	1.6±0.2			
	LМК316 BJ476ML <sup>*1</sup>	RoHS	47	X5R	10			±20%	1.6±0.2			
6.3V	JMK316 BJ106□D	RoHS	10	B/X5R	10	R	±10% ±20%	0.85±0.1				
	JMK316 BJ226MD <sup>*1</sup>	RoHS	22	X5R	10			0.85±0.1				
	JMK316 BJ476MD <sup>*1</sup>	RoHS	47	X5R	10			0.85±0.1				
	JMK316 BJ106□L	RoHS	10	B/X5R <sup>*2</sup>	5			±10% ±20%	1.6±0.2			
	JMK316 BJ226□L	RoHS	22	B/X5R	10			±20%	1.6±0.2			
	JMK316 BJ476ML	RoHS	47	X5R	10			±10% ±20%	1.6±0.2			
4V	JMK316 BJ107ML <sup>*1,*3</sup>	RoHS	100	X5R	10			R	±20%	1.6±0.2		
	AMK316 BJ107ML <sup>*1</sup>	RoHS	100	X5R	10					1.6±0.2		

□ Please specify the capacitance tolerance code.

\*1 1.5 times the rated voltage is applied to the chip during the high temperature loading test.

\*2 We may provide X7R for some items according to the individual specification.

\*3 The exchange of individual specification is necessary depending on the application and circuit condition. Please contact Taiyo Yuden sales channels.

[Temp.char. B7:X7R]

Rated Voltage	Ordering code	EHS (Environmental Hazardous Substances)	Capacitance [ $\mu$ F]	Temperature characteristics	Dissipation factor (%) Max.	Soldering method R:Reflow soldering W:Wave soldering	Capacitance tolerance	Thickness [mm]		
50V	UMK316 B7 224□L	RoHS	0.22	X7R	2.5	R/W	±10% ±20%	1.6±0.2		
	UMK316 B7 474□L	RoHS	0.47	X7R	3.5			1.6±0.2		
	UMK316 B7 105□L	RoHS	1	X7R	3.5			1.6±0.2		
25V	TMK316 B7 105□L	RoHS	1	X7R	3.5			R	±10% ±20%	1.6±0.2
	TMK316 B7 225□L	RoHS	2.2	X7R	3.5					1.6±0.2
	TMK316 B7 106□L <sup>*1,*4</sup>	RoHS	10	X7R	10					1.6±0.2
16V	EMK316 B7 225□L	RoHS	2.2	X7R	3.5	R/W	±10% ±20%	1.6±0.2		
	EMK316 B7 106□L <sup>*4</sup>	RoHS	10	X7R	10	R		1.6±0.2		
	LМК316 B7 225□L	RoHS	2.2	X7R	3.5	R/W		1.6±0.2		
10V	LМК316 B7 475□L	RoHS	4.7	X7R	5	R		±10% ±20%	1.6±0.2	
	LМК316 B7 106□L <sup>*1,*4</sup>	RoHS	10	X7R	10				1.6±0.2	
	JMK316 B7 106□L	RoHS	10	X7R	5				1.6±0.2	
6.3V	JMK316 B7 106□L	RoHS	10	X7R	5	R	±20%		1.6±0.2	

□ Please specify the capacitance tolerance code.

\*1 1.5 times the rated voltage is applied to the chip during the high temperature loading test.

\*4 "D" is used for the internal code.

[Temp.char. F:F/Y5V]

Rated Voltage	Ordering code	EHS (Environmental Hazardous Substances)	Capacitance [ $\mu$ F]	Temperature characteristics	Dissipation factor (%) Max.	Soldering method R:Reflow soldering W:Wave soldering	Capacitance tolerance	Thickness [mm]
50V	UMK316 F225ZG	RoHS	2.2	F/Y5V	7	R/W	+80% -20%	1.25±0.1
35V	GМК316 F475ZG	RoHS	4.7	F/Y5V	7			1.25±0.1
	GМК316 F106ZL	RoHS	10	F/Y5V	9	1.6±0.2		
25V	TMK316 F106ZL	RoHS	10	F/Y5V	9	R		1.6±0.2
16V	EMK316 F106ZL	RoHS	10	F/Y5V	9			1.6±0.2
10V	LМК316 F475ZD	RoHS	4.7	F/Y5V	9			0.85±0.1
	LМК316 F226ZL	RoHS	22	F/Y5V	16			1.6±0.2
6.3V	JMK316 F106ZD	RoHS	10	F/Y5V	16			0.85±0.1

\* This catalog contains the typical specification only due to the limitation of space. When you consider purchase of our products, please check our specification. For details of each product (characteristics graph, reliability information, precautions for use, and so on), see our Web site (<http://www.ty-top.com/>) or CD catalogs.

## PART NUMBERS

### ● 325TYPE

[Temp.char. BJ:B/X5R]

Rated Voltage	Ordering code		EHS (Environmental Hazardous Substances)	Capacitance [ $\mu$ F]	Temperature characteristics	Dissipation factor [%] Max.	Soldering method R:Reflow soldering W:Wave soldering	Capacitance tolerance	Thickness (mm)
50V	UMK325 BJ475MM* <sup>1</sup>		RoHS	4.7	X5R	5	R	$\pm 20\%$	2.5 $\pm 0.2$
	UMK325 BJ106MM* <sup>1</sup>		RoHS	10	X5R	5			2.5 $\pm 0.2$
35V	GMK325 BJ225MN		RoHS	2.2	B/X5R	3.5			1.9 $\pm 0.2$
	GMK325 BJ475MN* <sup>1</sup>		RoHS	4.7	X5R	10			1.9 $\pm 0.2$
	GMK325 BJ106MN* <sup>1</sup>		RoHS	10	B/X5R	5			1.9 $\pm 0.2$
25V	TMK325 BJ106MD* <sup>1</sup>		RoHS	10	B/X5R	5			0.85 $\pm 0.1$
	TMK325 BJ335MN		RoHS	3.3	B/X5R* <sup>2</sup>	3.5			1.9 $\pm 0.2$
	TMK325 BJ475MN		RoHS	4.7	B/X5R* <sup>2</sup>	3.5			1.9 $\pm 0.2$
	TMK325 BJ106MN		RoHS	10	B/X5R	5			1.9 $\pm 0.2$
	TMK325 BJ106MM* <sup>1</sup>		RoHS	10	B/X5R* <sup>2</sup>	3.5			2.5 $\pm 0.2$
16V	EMK325 BJ106MD* <sup>1</sup>		RoHS	10	B/X5R	5			0.85 $\pm 0.1$
	EMK325 BJ226MD* <sup>1</sup>		RoHS	22	B/X5R	10			0.85 $\pm 0.1$
	EMK325 BJ475MN		RoHS	4.7	B/X5R* <sup>2</sup>	3.5			1.9 $\pm 0.2$
	EMK325 BJ106MN		RoHS	10	B/X5R	3.5			1.9 $\pm 0.2$
	EMK325 BJ226MM* <sup>1</sup>		RoHS	22	B/X5R	5			2.5 $\pm 0.2$
	EMK325 BJ476MM* <sup>1</sup>		RoHS	47	X5R	10			2.5 $\pm 0.2$
10V	LМК325 BJ335MD		RoHS	3.3	B/X5R	3.5			0.85 $\pm 0.1$
	LМК325 BJ475MD		RoHS	4.7	B/X5R	5			0.85 $\pm 0.1$
	LМК325 BJ106MD* <sup>1</sup>		RoHS	10	B/X5R	5			0.85 $\pm 0.1$
	LМК325 BJ226MY* <sup>1</sup>		RoHS	22	B/X5R	5			1.9+0.1/-0.2
	LМК325 BJ106MN		RoHS	10	B/X5R* <sup>2</sup>	3.5	1.9 $\pm 0.2$		
	LМК325 BJ226MM		RoHS	22	B/X5R	5	2.5 $\pm 0.2$		
	LМК325 BJ476MM* <sup>1</sup>		RoHS	47	X5R	10	2.5 $\pm 0.2$		
	LМК325 BJ107MM* <sup>1</sup>		RoHS	100	X5R	10	2.5 $\pm 0.3$		
6.3V	JMK325 BJ226MY		RoHS	22	B/X5R	5	1.9+0.1/-0.2		
	JMK325 BJ107MY* <sup>1</sup>		RoHS	100	X5R	10	1.9+0.1/-0.2		
	JMK325 BJ476MN* <sup>1</sup>		RoHS	47	X5R	10	1.9 $\pm 0.2$		
	JMK325 BJ476MM* <sup>1</sup>		RoHS	47	X5R	10	2.5 $\pm 0.2$		
	JMK325 BJ107MM* <sup>1</sup>		RoHS	100	X5R	10	2.5 $\pm 0.3$		

Please specify the capacitance tolerance code.

\*1 1.5 times the rated voltage is applied to the chip during the high temperature loading test.

\*2 We may provide X7R for some items according to the individual specification.

[Temp.char. B7:X7R]

Rated Voltage	Ordering code		EHS (Environmental Hazardous Substances)	Capacitance [ $\mu$ F]	Temperature characteristics	Dissipation factor [%] Max.	Soldering method R:Reflow soldering W:Wave soldering	Capacitance tolerance	Thickness (mm)
25V	TMK325 B7 335MN		RoHS	3.3	X7R	3.5	R	$\pm 20\%$	1.9 $\pm 0.2$
	TMK325 B7 475MN* <sup>1</sup>		RoHS	4.7	X7R	3.5			1.9 $\pm 0.2$
16V	EMK325 B7 475MN		RoHS	4.7	X7R	3.5			1.9 $\pm 0.2$
10V	LМК325 B7 106MN		RoHS	10	X7R	3.5			1.9 $\pm 0.2$
	LМК325 B7 106MM		RoHS	10	X7R	3.5			1.9 $\pm 0.2$

Please specify the capacitance tolerance code.

\*1 1.5 times the rated voltage is applied to the chip during the high temperature loading test.

[Temp.char. F:F/Y5V]

Rated Voltage	Ordering code		EHS (Environmental Hazardous Substances)	Capacitance [ $\mu$ F]	Temperature characteristics	Dissipation factor [%] Max.	Soldering method R:Reflow soldering W:Wave soldering	Capacitance tolerance	Thickness (mm)
16V	EMK325 F226ZN		RoHS	22	F/Y5V	16	R	+80% -20%	1.9 $\pm 0.2$
10V	LМК325 F226ZN		RoHS	22	F/Y5V	16			1.9 $\pm 0.2$
6.3V	JMK325 F476ZN		RoHS	47	F/Y5V	16			1.9 $\pm 0.2$

\* This catalog contains the typical specification only due to the limitation of space. When you consider purchase of our products, please check our specification.  
For details of each product (characteristics graph, reliability information, precautions for use, and so on), see our Web site (<http://www.ty-top.com/>) or CD catalogs.

## ELECTRICAL CHARACTERISTICS

### ● Example of Impedance ESR vs. Frequency characteristics

#### ■ Taiyo Yuden multilayer ceramic capacitor

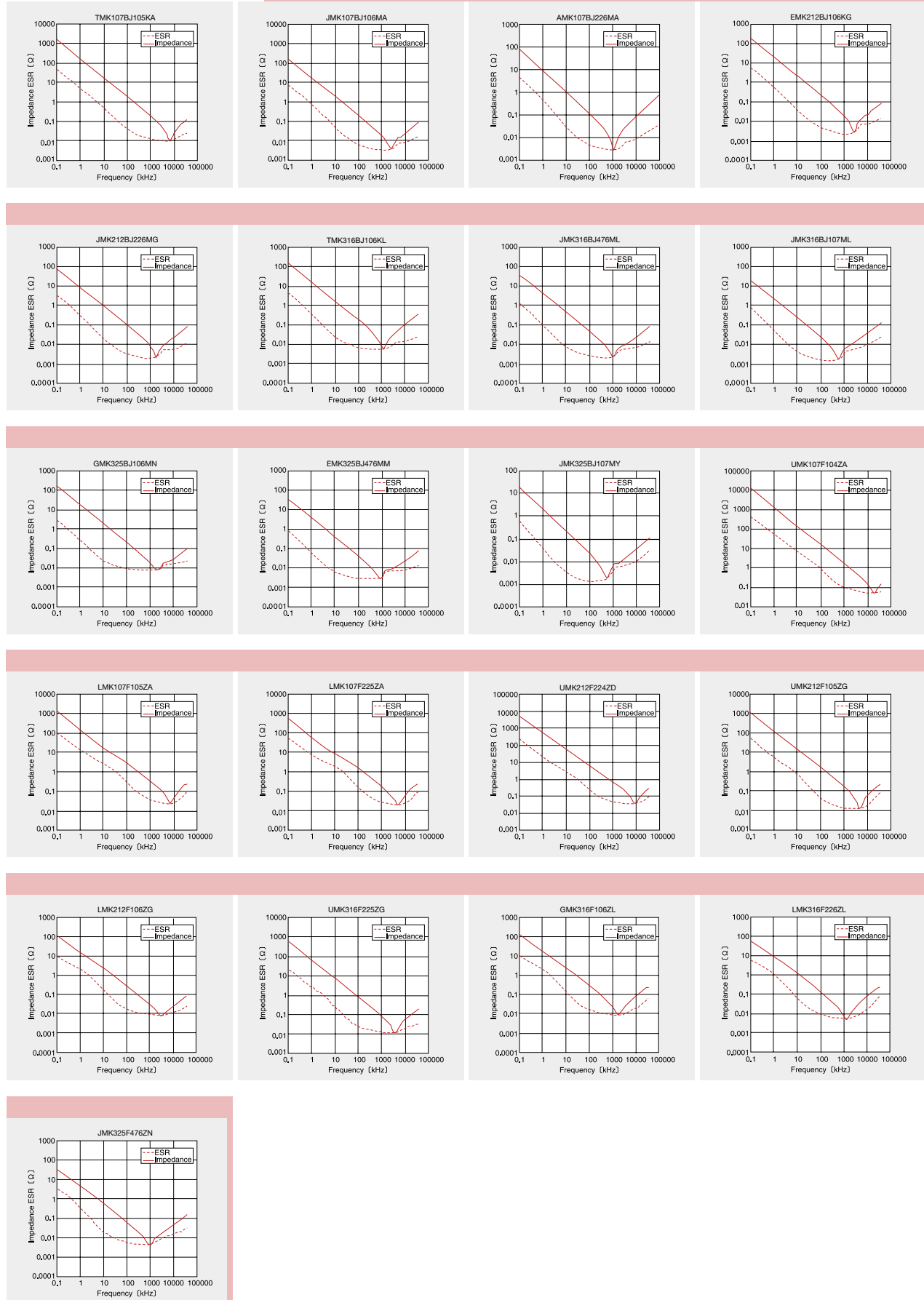

\* This catalog contains the typical specification only due to the limitation of space. When you consider purchase of our products, please check our specification.  
 For details of each product (characteristics graph, reliability information, precautions for use, and so on), see our Web site (<http://www.ty-top.com/>) or CD catalogs.

# STANDARD MULTILAYER CERAMIC CAPACITORS (CLASS1:TEMPERATURE COMPENSATING TYPE)



REFLOW

## FEATURES

- Improved higher density mounting.
- Monolithic structure provides higher reliability.
- A wide range of capacitance values available in standard case sizes.

## APPLICATIONS

- General electronic equipment
- Communication equipment (cellular phone, wireless applications, etc.)

## ORDERING CODE

U M K 1 0 5 C H 1 0 1 J V - F  $\triangle$

**1 Rated voltage (VDC)**

E	16
T	25
U	50

**2 Series name**

M	Multilayer ceramic capacitor
---	------------------------------

**3 End termination**

K	Plated
---	--------

**4 Dimensions (EIA) L×W(mm)**

042 (01005)	0.4×0.2
063 (0201)	0.6×0.3
105 (0402)	1.0×0.5

**5 Temperature characteristics (ppm/°C)**

C□: 0	CH, CJ, CK	Tolerance H: ±60 J: ±120 K: ±250
R□: -220	RH	
S□: -330	SH, SJ, SK	
T□: -470	TJ, TK	
U□: -750	UJ, UK	
SL: +350~-1000		

□=Tolerance

**6 Nominal capacitance (pF)**

example	
OR5	0.5
010	1
100	10

※R=decimal point

**7 Capacitance tolerance**

C	±0.25pF
D	±0.5pF
F	±1pF
J	±5%
K	±10%

**8 Thickness (mm)**

C	0.2
P, T	0.3
V	0.5
W	0.5

**9 Special code**

-	Standard Product
---	------------------

**10 Packaging**

F	φ178mm Taping (2mm pitch)
---	---------------------------

**11 Internal code**

$\triangle$	Standard Product
-------------	------------------

$\triangle$ =Blank space

## EXTERNAL DIMENSIONS/STANDARD QUANTITY

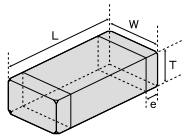

Type (EIA)	L	W	T	e	Standard quantity [pcs]	
					Paper tape	Embossed tape
□MK042 (01005)	0.4±0.02 (0.016±0.001)	0.2±0.02 (0.008±0.001)	0.2±0.02 (0.008±0.001)	C	0.1±0.03 (0.004±0.001)	20000 / -
□MK063 (0201)	0.6±0.03 (0.024±0.001)	0.3±0.03 (0.012±0.001)	0.3±0.03 (0.012±0.001)	P, T	0.15±0.05 (0.006±0.002)	15000 / -
□MK105 (0402)	1.0±0.05 (0.039±0.002)	0.5±0.05 (0.020±0.002)	0.5±0.05 (0.020±0.002)	W, V	0.25±0.10 (0.010±0.004)	10000 / -

Unit : mm (inch)

## AVAILABLE CAPACITANCE RANGE

Cap [pF]	Type	042			063		105					
		Temp.char.			C□	U□	C□	U□	SL	R□	S□	T□
		VDC			16V	50V	25V	50V				
0.5	OR5											
1	010											
1.5	1R5											
2	020											
3	030											
4	040											
5	050											
6	060											
7	070											
8	080											
9	090											
10	100											
12	120											
15	150											
18	180											
22	220											
27	270											
33	330											
39	390											
47	470											
56	560											
68	680											
82	820											
100	101											
120	121											
150	151											
180	181											
220	221											
270	271											
330	331											
390	391											
470	471											
560	561											
680	681											
820	821											
1000	102											

Note: Letters in the table indicate thickness.

\* This catalog contains the typical specification only due to the limitation of space. When you consider purchase of our products, please check our specification. For details of each product (characteristics graph, reliability information, precautions for use, and so on), see our Web site (<http://www.ty-top.com/>) or CD catalogs.



**PART NUMBERS**

**042TYPE**

Class 1

Rated Voltage	Ordering code	EHS (Environmental Hazardous Substances)	Capacitance (pF)	Temperature characteristics (EIA)	Q	Soldering method R:Reflow soldering W:Wave soldering	Capacitance tolerance	Thickness (mm) (inch)
16V	EMK042 CK0R5CC	RoHS	0.5	CK	410	R	±0.25pF	0.2±0.02 (0.008±0.001)
	EMK042 CK010CC	RoHS	1		420			
	EMK042 CK1R5CC	RoHS	1.5		430			
	EMK042 CK020CC	RoHS	2		440			
	EMK042 CJ030CC	RoHS	3	CJ	460		±0.5pF	
	EMK042 CH040CC	RoHS	4	CH	480			
	EMK042 CH050CC	RoHS	5		500			
	EMK042 CH060DC	RoHS	6		520			
	EMK042 CH070DC	RoHS	7		540			
	EMK042 CH080DC	RoHS	8		560			
	EMK042 CH090DC	RoHS	9		580			
	EMK042 CH100DC	RoHS	10		600			
	EMK042 CH120JC	RoHS	12		640			
	EMK042 CH150JC	RoHS	15		700			
	EMK042 CH180JC	RoHS	18		760			
	EMK042 CH220JC	RoHS	22		840			
	EMK042 CH270JC	RoHS	27		940			
	EMK042 CH330JC	RoHS	33		1000			
	EMK042 CH390JC	RoHS	39		1000			
	EMK042 CH470JC	RoHS	47		1000			
EMK042 CH560JC	RoHS	56	1000					
EMK042 CH680JC	RoHS	68	1000					
EMK042 CH820JC	RoHS	82	1000					
EMK042 CH101JC	RoHS	100	1000					

Note: "W" is used for the internal code.

Note: Please contact Taiyo Yuden sales channels about items (capacitance, tolerance, and temperature characteristics) other than listed above.

**063TYPE**

Class1 [C△ characteristic]

Rated Voltage	Ordering code	EHS (Environmental Hazardous Substances)	Capacitance (pF)	Temperature characteristics (EIA)	Q	Soldering method R:Reflow soldering W:Wave soldering	Capacitance tolerance	Thickness (mm) (inch)
50V	UMK063 CK0R5CP	RoHS	0.5	CK	410	R	±0.25pF	0.3±0.03 (0.012±0.001)
	UMK063 CK010CP	RoHS	1		420			
	UMK063 CK1R5CP	RoHS	1.5		430			
	UMK063 CK020CP	RoHS	2		440			
	UMK063 CJ030CP	RoHS	3	CJ	460		±0.5pF	
	UMK063 CH040CP	RoHS	4	CH	480			
	UMK063 CH050CP	RoHS	5		500			
	UMK063 CH060DP	RoHS	6		520			
	UMK063 CH070DP	RoHS	7		540			
	UMK063 CH080DT	RoHS	8		560			
	UMK063 CH090DT	RoHS	9		580			
	UMK063 CH100DT	RoHS	10		600			
	UMK063 CH120JT	RoHS	12		640			
	UMK063 CH150JT	RoHS	15		700			
	UMK063 CH180JT	RoHS	18		760			
	UMK063 CH220JT	RoHS	22		840			
	UMK063 CH270JT	RoHS	27		940			
	UMK063 CH330JT	RoHS	33		1000			
	UMK063 CH390JT	RoHS	39		1000			
	UMK063 CH470JT	RoHS	47		1000			
UMK063 CH560JT	RoHS	56	1000					
UMK063 CH680JT	RoHS	68	1000					
UMK063 CH820JT	RoHS	82	1000					
UMK063 CH101JT	RoHS	100	1000					

Note: "G" is used for the special code when the capacitance is less than 8pF.

Note: Please contact Taiyo Yuden sales channels about items (capacitance, tolerance, and temperature characteristics) other than listed above.

Class1 [U△ characteristic]

Rated Voltage	Ordering code	EHS (Environmental Hazardous Substances)	Capacitance (pF)	Temperature characteristics (EIA)	Q	Soldering method R:Reflow soldering W:Wave soldering	Capacitance tolerance	Thickness (mm) (inch)
25V	TMK063 UK0R5CT	RoHS	0.5	UK	410	R	±0.25pF	0.3±0.03 (0.012±0.001)
	TMK063 UK010CT	RoHS	1		420			
	TMK063 UK1R5CT	RoHS	1.5		430			
	TMK063 UK020CT	RoHS	2		440			
	TMK063 UK030CT	RoHS	3	UJ	460		±0.5pF	
	TMK063 UJ040CT	RoHS	4		480			
	TMK063 UJ050CT	RoHS	5		500			
	TMK063 UJ060DT	RoHS	6		520			
	TMK063 UJ070DT	RoHS	7	540				
	TMK063 UJ080DT	RoHS	8	560				
	TMK063 UJ090DT	RoHS	9	580				
	TMK063 UJ100DT	RoHS	10	600				
	TMK063 UJ120JT	RoHS	12	640				
	TMK063 UJ150JT	RoHS	15	700				

Note: Please contact Taiyo Yuden sales channels about items (capacitance and tolerance) other than listed above.

\* This catalog contains the typical specification only due to the limitation of space. When you consider purchase of our products, please check our specification. For details of each product (characteristics graph, reliability information, precautions for use, and so on), see our Web site (<http://www.ty-top.com/>) or CD catalogs.

**PART NUMBERS**

**105TYPE**

Class1 [C△ characteristic]

Rated Voltage	Ordering code	EHS (Environmental Hazardous Substances)	Capacitance (pF)	Temperature characteristics (EIA)	Q	Soldering method R:Reflow soldering W:Wave soldering	Capacitance tolerance	Thickness [mm] (inch)
50V	UMK105 CK0R5CW	RoHS	0.5	CK	410	R	±0.25pF	0.5±0.05 (0.020±0.002)
	UMK105 CK010CW	RoHS	1		420			
	UMK105 CK1R5CW	RoHS	1.5		430			
	UMK105 CK020CW	RoHS	2		440			
	UMK105 CJ030CW	RoHS	3	CJ	460			
	UMK105 CH040CW	RoHS	4	CH	480		±0.5pF	
	UMK105 CH050CW	RoHS	5		500			
	UMK105 CH060DW	RoHS	6		520			
	UMK105 CH070DW	RoHS	7		540			
	UMK105 CH080DV	RoHS	8		560			
	UMK105 CH090DV	RoHS	9		580			
	UMK105 CH100DV	RoHS	10		600			
	UMK105 CH120JV	RoHS	12		640			
	UMK105 CH150JV	RoHS	15		700			
	UMK105 CH180JV	RoHS	18		760			
	UMK105 CH220JV	RoHS	22		840			
	UMK105 CH270JV	RoHS	27		940			
	UMK105 CH330JV	RoHS	33		1000			
	UMK105 CH390JV	RoHS	39		1000			
	UMK105 CH470JV	RoHS	47		1000			
	UMK105 CH560JV	RoHS	56		1000			
	UMK105 CH680JV	RoHS	68		1000			
	UMK105 CH820JV	RoHS	82		1000			
	UMK105 CH101JV	RoHS	100		1000			
	UMK105 CH121JV	RoHS	120		1000			
	UMK105 CH151JV	RoHS	150	1000				
	UMK105 CH181JV	RoHS	180	1000				
	UMK105 CH221JV	RoHS	220	1000				
	UMK105 CH271JV	RoHS	270	1000				
	UMK105 CH331JV	RoHS	330	1000				

Note: Please contact Taiyo Yuden sales channels about items (capacitance, tolerance, and characteristics) other than listed above.

Class1 [U△ characteristic]

Rated Voltage	Ordering code	EHS (Environmental Hazardous Substances)	Capacitance (pF)	Temperature characteristics (EIA)	Q	Soldering method R:Reflow soldering W:Wave soldering	Capacitance tolerance	Thickness [mm] (inch)
50V	UMK105 UK0R5CW	RoHS	0.5	UK	410	R	±0.25pF	0.5±0.05 (0.020±0.002)
	UMK105 UK010CW	RoHS	1		420			
	UMK105 UK1R5CW	RoHS	1.5		430			
	UMK105 UK020CW	RoHS	2		440			
	UMK105 UK030CW	RoHS	3	UJ	460		±0.5pF	
	UMK105 UJ040CW	RoHS	4		480			
	UMK105 UJ050CW	RoHS	5		500			
	UMK105 UJ060DW	RoHS	6		520			
	UMK105 UJ070DW	RoHS	7		540			
	UMK105 UJ080DW	RoHS	8		560			
	UMK105 UJ090DW	RoHS	9		580			
	UMK105 UJ100DW	RoHS	10		600			
	UMK105 UJ120JW	RoHS	12		640			
	UMK105 UJ150JW	RoHS	15		700			
	UMK105 UJ180JW	RoHS	18		760			
	UMK105 UJ220JV	RoHS	22		840			
	UMK105 UJ270JV	RoHS	27		940			
	UMK105 UJ330JV	RoHS	33		1000			
	UMK105 UJ390JV	RoHS	39		1000			
	UMK105 UJ470JV	RoHS	47		1000			
	UMK105 UJ560JV	RoHS	56		1000			
	UMK105 UJ680JV	RoHS	68		1000			
	UMK105 UJ820JV	RoHS	82		1000			
	UMK105 UJ101JV	RoHS	100		1000			
	UMK105 UJ121JV	RoHS	120	1000				
	UMK105 UJ151JV	RoHS	150	1000				
	UMK105 UJ181JV	RoHS	180	1000				
	UMK105 UJ221JV	RoHS	220	1000				
	UMK105 UJ271JV	RoHS	270	1000				
	UMK105 UJ331JV	RoHS	330	1000				

Note: Please contact Taiyo Yuden sales channels about items (capacitance and tolerance) other than listed above.

\* This catalog contains the typical specification only due to the limitation of space. When you consider purchase of our products, please check our specification. For details of each product (characteristics graph, reliability information, precautions for use, and so on), see our Web site (<http://www.ty-top.com/>) or CD catalogs.

**PART NUMBERS**

Class1 [SL characteristic]

Rated Voltage	Ordering code	EHS (Environmental Hazardous Substances)	Capacitance (pF)	Temperature characteristics (EIA)	Q	Soldering method R:Reflow soldering W:Wave soldering	Capacitance tolerance	Thickness (mm) (inch)
50V	UMK105 SL121JV	RoHS	120	SL	1000	R	±5%	0.5±0.05 (0.020±0.002)
	UMK105 SL151JV	RoHS	150		1000			
	UMK105 SL181JV	RoHS	180		1000			
	UMK105 SL221JV	RoHS	220		1000			
	UMK105 SL271JV	RoHS	270		1000			
	UMK105 SL331JV	RoHS	330		1000			

Note: Please contact Taiyo Yuden sales channels about items (capacitance and tolerance) other than listed above.

Class1 [RH characteristic]

Rated Voltage	Ordering code	EHS (Environmental Hazardous Substances)	Capacitance (pF)	Temperature characteristics (EIA)	Q	Soldering method R:Reflow soldering W:Wave soldering	Capacitance tolerance	Thickness (mm) (inch)
50V	UMK105 RH5R6JW	RoHS	5.6	RH	512	R	±5%	0.5±0.05 (0.020±0.002)
	UMK105 RH6R8JW	RoHS	6.8		536			
	UMK105 RH8R2JW	RoHS	8.2		564			
	UMK105 RH100JW	RoHS	10		600			
	UMK105 RH120JW	RoHS	12		640			
	UMK105 RH150JW	RoHS	15		700			
	UMK105 RH180JW	RoHS	18		760			
	UMK105 RH200JW	RoHS	20		800			

Note: Please contact Taiyo Yuden sales channels about items (capacitance and tolerance) other than listed above.

Class1 [S△ characteristic]

Rated Voltage	Ordering code	EHS (Environmental Hazardous Substances)	Capacitance (pF)	Temperature characteristics (EIA)	Q	Soldering method R:Reflow soldering W:Wave soldering	Capacitance tolerance	Thickness (mm) (inch)
50V	UMK105 SK0R5BW	RoHS	0.5	SK	410	R	±0.1pF	0.5±0.05 (0.020±0.002)
	UMK105 SK010BW	RoHS	1		420			
	UMK105 SK1R2BW	RoHS	1.2		424			
	UMK105 SK1R5BW	RoHS	1.5		430			
	UMK105 SK1R8BW	RoHS	1.8		436			
	UMK105 SK2R2JW	RoHS	2.2		444			
	UMK105 SK2R7JW	RoHS	2.7	454				
	UMK105 SJ3R3JW	RoHS	3.3	SJ	466		±5%	
	UMK105 SJ3R9JW	RoHS	3.9		478			
	UMK105 SH4R7JW	RoHS	4.7	SH	494			
	UMK105 SH5R6JW	RoHS	5.6		512			
	UMK105 SH6R8JW	RoHS	6.8		536			
	UMK105 SH8R2JW	RoHS	8.2		564			
	UMK105 SH100JW	RoHS	10		600			
	UMK105 SH120JW	RoHS	12		640			
	UMK105 SH150JW	RoHS	15		700			
	UMK105 SH180JW	RoHS	18		760			
	UMK105 SH200JW	RoHS	20		800			

Note: Please contact Taiyo Yuden sales channels about items (capacitance and tolerance) other than listed above.

Class1 [T△ characteristic]

Rated Voltage	Ordering code	EHS (Environmental Hazardous Substances)	Capacitance (pF)	Temperature characteristics (EIA)	Q	Soldering method R:Reflow soldering W:Wave soldering	Capacitance tolerance	Thickness (mm) (inch)
50V	UMK105 TK0R5BW	RoHS	0.5	TK	410	R	±0.1pF	0.5±0.05 (0.020±0.002)
	UMK105 TK010BW	RoHS	1		420			
	UMK105 TK1R2BW	RoHS	1.2		424			
	UMK105 TK1R5BW	RoHS	1.5		430			
	UMK105 TK1R8BW	RoHS	1.8		436			
	UMK105 TK2R2JW	RoHS	2.2		444			
	UMK105 TK2R7JW	RoHS	2.7	454				
	UMK105 TK3R3JW	RoHS	3.3	TK	466		±5%	
	UMK105 TK3R9JW	RoHS	3.9		478			
	UMK105 TJ4R7JW	RoHS	4.7	TJ	494			
	UMK105 TJ5R6JW	RoHS	5.6		512			
	UMK105 TJ6R8JW	RoHS	6.8		536			
	UMK105 TJ8R2JW	RoHS	8.2		564			
	UMK105 TJ100JW	RoHS	10		600			
	UMK105 TJ120JW	RoHS	12		640			
	UMK105 TJ150JW	RoHS	15		700			
	UMK105 TJ180JW	RoHS	18		760			
	UMK105 TJ200JW	RoHS	20		800			

Note: Please contact Taiyo Yuden sales channels about items (capacitance and tolerance) other than listed above.

\* This catalog contains the typical specification only due to the limitation of space. When you consider purchase of our products, please check our specification. For details of each product (characteristics graph, reliability information, precautions for use, and so on), see our Web site (<http://www.ty-top.com/>) or CD catalogs.

# STANDARD MULTILAYER CERAMIC CAPACITORS (CLASS2 :HIGH DIELECTRIC CONSTANT TYPE)



REFLOW

## FEATURES

- Improved higher density mounting.
- Monolithic structure provides higher reliability.
- A wide range of capacitance values available in standard case sizes.

## APPLICATIONS

- General electronic equipment
- Communication equipment (cellular phone, wireless applications, etc.)

## ORDERING CODE

L M K 1 0 5 B J 1 0 4 K V - F △

**1 Rated voltage (VDC)**

A	4
J	6.3
L	10
E	16
T	25
G	35
U	50

**2 Series name**

M	Multilayer ceramic capacitor
---	------------------------------

**3 End termination**

K	Plated
---	--------

**4 Dimensions (EIA) L×W (mm)**

042 (01005)	0.4×0.2
063 (0201)	0.6×0.3
105 (0402)	1.0×0.5

**5 Temperature characteristics code**

BJ	B
B7	X5R
△F	F
	Y5V

△=Blank space

**6 Nominal capacitance (pF)**

example	
102	1000
223	22000

**7 Capacitance tolerance**

K	±10%
M	±20%
Z	+80 -20%

**8 Thickness (mm)**

C	0.2
P	0.3
V	0.5

**9 Special code**

-	Standard Product
---	------------------

**10 Packaging**

F	φ178mm Taping (2mm pitch)
---	---------------------------

**11 Internal code**

△	Standard Product
---	------------------

△=Blank space

## EXTERNAL DIMENSIONS/STANDARD QUANTITY

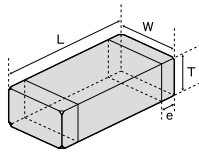

Type (EIA)	L	W	T	e	Standard quantity [pcs]	
					Paper tape	Embossed tape
□MK042 (01005)	0.4±0.02 (0.016±0.001)	0.2±0.02 (0.008±0.001)	0.2±0.02 (0.008±0.001)	C 0.1±0.03 (0.004±0.001)	20000	-
□MK063 (0201)	0.6±0.03 (0.024±0.001)	0.3±0.03 (0.012±0.001)	0.3±0.03 (0.012±0.001)	P 0.15±0.05 (0.006±0.002)	15000	-
□MK105 (0402)	1.0±0.05* (0.039±0.002)	0.5±0.05* (0.020±0.002)	0.5±0.05* (0.020±0.002)	V 0.25±0.10 (0.010±0.004)	10000	-

Note:\*1. Including dimension tolerance±0.1mm

Unit : mm (inch)

## AVAILABLE CAPACITANCE RANGE

Cap [pF]	Type	042			063			105																	
		Temp.char.			Temp.char.			Temp.char.			Temp.char.			Temp.char.			Temp.char.			Temp.char.					
		X7R	B/X5R	X5R	X7R	B/X5R	X5R	X7R	B/X5R	X5R	X7R	B/X5R	X5R	X7R	B/X5R	X5R	F/Y5V	X7R	B/X5R	X5R	F/Y5V	X7R	B/X5R	X5R	
100	101																								
150	151																								
220	221																								
330	331	C	C																						
470	471																								
680	681																								
1000	102																								
1500	152																								
2200	222																								
3300	332																								
4700	472																								
6800	682																								
10000	103																								
15000	153																								
22000	223																								
33000	333																								
47000	473																								
68000	683																								
100000	104																								
220000	224																								
330000	334																								
470000	474																								
1000000	105																								
2200000	225																								
3300000	335																								
4700000	475																								

Note : Letters in the table indicate thickness.

Temp.char.Code	Applicable standard	Temperature characteristics			Capacitance tolerance [%]
		Temperature range (°C)	Ref. Temp. (°C)	Capacitance change [%]	
B/BJ	JIS	B	-25~+85	20	±10
	EIA	X5R	-55~+85	25	±15
B7	EIA	X7R	-55~+125	25	±15
	JIS	F	-25~+85	20	+30/-80
F	EIA	Y5V	-30~+85	25	+22/-82

\* This catalog contains the typical specification only due to the limitation of space. When you consider purchase of our products, please check our specification. For details of each product (characteristics graph, reliability information, precautions for use, and so on), see our Web site (<http://www.ty-top.com/>) or CD catalogs.

**PART NUMBERS**

**042TYPE (01005 case size)**

[Temp.char. BJ:B/X5R]

Rated Voltage	Ordering code	EHS (Environmental Hazardous Substances)	Capacitance [pF]	Temperature characteristics	Dissipation factor [%] Max.	Soldering method R:Reflow soldering W:Wave soldering	Capacitance tolerance	Thickness [mm] (inch)
10V	LMK042 BJ101□C	RoHS	100	B/X5R <sup>*2</sup>	5	R	±10% ±20%	0.2±0.02 (0.008±0.001)
	LMK042 BJ151□C	RoHS	150					
	LMK042 BJ221□C	RoHS	220					
	LMK042 BJ331□C	RoHS	330					
	LMK042 BJ471□C	RoHS	470					
	LMK042 BJ681□C	RoHS	680					
	LMK042 BJ102□C	RoHS	1000	X5R	10			
	LMK042 BJ152□C <sup>*1</sup>	RoHS	1500					
	LMK042 BJ222□C <sup>*1</sup>	RoHS	2200					
	LMK042 BJ332□C <sup>*1</sup>	RoHS	3300					
LMK042 BJ472□C <sup>*1</sup>	RoHS	4700						
LMK042 BJ682□C <sup>*1</sup>	RoHS	6800						
LMK042 BJ103□C <sup>*1</sup>	RoHS	10000	B/X5R <sup>*2</sup>	10				
JMK042 BJ152□C <sup>*1</sup>	RoHS	1500						
JMK042 BJ222□C <sup>*1</sup>	RoHS	2200						
JMK042 BJ332□C <sup>*1</sup>	RoHS	3300						
JMK042 BJ472□C <sup>*1</sup>	RoHS	4700						
JMK042 BJ682□C <sup>*1</sup>	RoHS	6800						
JMK042 BJ103□C <sup>*1</sup>	RoHS	10000						

□ Please specify the capacitance tolerance code.  
<sup>\*1</sup> 1.5 times the rated voltage is applied to the chip during the high temperature loading test.  
<sup>\*2</sup> We may provide X7R/X7S for some items according to the individual specification.  
 Note: "W" is used for the internal code.

[Temp.char. B7 : X7R]

Rated Voltage	Ordering code	EHS (Environmental Hazardous Substances)	Capacitance [pF]	Temperature characteristics	Dissipation factor [%] Max.	Soldering method R:Reflow soldering W:Wave soldering	Capacitance tolerance	Thickness [mm] (inch)
10V	LMK042 B7 101 □ C	RoHS	100	X7R	5	R	±10% ±20%	0.2±0.02 (0.008±0.001)
	LMK042 B7 151 □ C	RoHS	150					
	LMK042 B7 221 □ C	RoHS	220					
	LMK042 B7 331 □ C	RoHS	330					
	LMK042 B7 471 □ C	RoHS	470					
	LMK042 B7 681 □ C	RoHS	680					
	LMK042 B7 102 □ C	RoHS	1000					

□ Please specify the capacitance tolerance code.  
 Note: "W" is used for the internal code.

**063TYPE (0201 case size)**

[Temp.char. BJ:B/X5R]

Rated Voltage	Ordering code	EHS (Environmental Hazardous Substances)	Capacitance [pF]	Temperature characteristics	Dissipation factor [%] Max.	Soldering method R:Reflow soldering W:Wave soldering	Capacitance tolerance	Thickness [mm] (inch)
25V	TMK063 BJ101□P	RoHS	100	B/X5R <sup>*2</sup>	3.5	R	±10% ±20%	0.3±0.03 (0.012±0.001)
	TMK063 BJ151□P	RoHS	150					
	TMK063 BJ221□P	RoHS	220					
	TMK063 BJ331□P	RoHS	330					
	TMK063 BJ471□P	RoHS	470					
	TMK063 BJ681□P	RoHS	680					
	TMK063 BJ102□P	RoHS	1000	B/X5R	5			
	TMK063 BJ152□P	RoHS	1500					
	TMK063 BJ222□P	RoHS	2200					
	TMK063 BJ332□P	RoHS	3300					
TMK063 BJ472□P	RoHS	4700						
TMK063 BJ682□P	RoHS	6800						
TMK063 BJ103□P	RoHS	10000	B/X5R <sup>*2</sup>	10				
EMK063 BJ152□P	RoHS	1500						
EMK063 BJ222□P	RoHS	2200						
EMK063 BJ332□P	RoHS	3300						
EMK063 BJ472□P	RoHS	4700						
EMK063 BJ682□P	RoHS	6800						
EMK063 BJ103□P	RoHS	10000	B/X5R	7.5				
LMK063 BJ223□P <sup>*1</sup>	RoHS	22000						
LMK063 BJ333□P <sup>*1</sup>	RoHS	33000						
LMK063 BJ473□P <sup>*1</sup>	RoHS	47000						
LMK063 BJ683□P <sup>*1</sup>	RoHS	68000						
LMK063 BJ104□P <sup>*1</sup>	RoHS	100000						
LMK063 BJ224MP <sup>*1</sup>	RoHS	220000	B/X5R	10				
JMK063 BJ223□P <sup>*1</sup>	RoHS	22000						
JMK063 BJ333□P <sup>*1</sup>	RoHS	33000						
JMK063 BJ473□P <sup>*1</sup>	RoHS	47000						
JMK063 BJ683□P <sup>*1</sup>	RoHS	68000						
JMK063 BJ104□P <sup>*1</sup>	RoHS	100000						
JMK063 BJ224MP <sup>*1</sup>	RoHS	220000						

To next page

\* This catalog contains the typical specification only due to the limitation of space. When you consider purchase of our products, please check our specification.  
 For details of each product (characteristics graph, reliability information, precautions for use, and so on), see our Web site (<http://www.ty-top.com/>) or CD catalogs.

**PART NUMBERS**

Rated Voltage	Ordering code	EHS (Environmental Hazardous Substances)	Capacitance [pF]	Temperature characteristics	Dissipation factor [%] Max.	Soldering method R:Reflow soldering W:Wave soldering	Capacitance tolerance	Thickness [mm] (inch)
4V	AMK063 BJ224MP*1	RoHS	220000	X5R	10	R	±20%	0.3±0.03 (0.012±0.001)
	AMK063 BJ334MP*1,*3	RoHS	330000					
	AMK063 BJ474MP*1,*3	RoHS	470000					

□ Please specify the capacitance tolerance code.

\*1 1.5 times the rated voltage is applied to the chip during the high temperature loading test.

\*2 We may provide X7R for some items according to the individual specification.

\*3 The exchange of individual specification is necessary depending on the application and circuit condition. Please contact Taiyo Yuden sales channels.

[Temp.char. B7 : X7R]

Rated Voltage	Ordering code	EHS (Environmental Hazardous Substances)	Capacitance [pF]	Temperature characteristics	Dissipation factor [%] Max.	Soldering method R:Reflow soldering W:Wave soldering	Capacitance tolerance	Thickness [mm] (inch)
25V	TMK063 B7 101□P	RoHS	100	X7R	3.5	R	±10% ±20%	0.3±0.03 (0.012±0.001)
	TMK063 B7 151□P	RoHS	150					
	TMK063 B7 221□P	RoHS	220					
	TMK063 B7 331□P	RoHS	330					
	TMK063 B7 471□P	RoHS	470					
	TMK063 B7 681□P	RoHS	680					
16V	TMK063 B7 102□P	RoHS	1000	X7R	5	R	±10% ±20%	0.3±0.03 (0.012±0.001)
	EMK063 B7 152□P	RoHS	1500					
	EMK063 B7 222□P	RoHS	2200					
	EMK063 B7 332□P	RoHS	3300					
	EMK063 B7 472□P	RoHS	4700					
	EMK063 B7 682□P	RoHS	6800					
	EMK063 B7 103□P	RoHS	10000					

□ Please specify the capacitance tolerance code.

● 105TYPE (0402 case size)

[Temp.char. BJ:B/X5R]

Rated Voltage	Ordering code	EHS (Environmental Hazardous Substances)	Capacitance [pF]	Temperature characteristics	Dissipation factor [%] Max.	Soldering method R:Reflow soldering W:Wave soldering	Capacitance tolerance	Thickness [mm] (inch)
50V	UMK105 BJ 221□V	RoHS	220	B/X5R*2	2.5	R	±10% ±20%	0.5±0.05 (0.02±0.002)
	UMK105 BJ 331□V	RoHS	330					
	UMK105 BJ 471□V	RoHS	470					
	UMK105 BJ 681□V	RoHS	680					
	UMK105 BJ 102□V	RoHS	1000					
	UMK105 BJ 152□V	RoHS	1500					
	UMK105 BJ 222□V	RoHS	2200					
	UMK105 BJ 332□V	RoHS	3300					
	UMK105 BJ 472□V	RoHS	4700					
	UMK105 BJ 682□V*1	RoHS	6800					
	UMK105 BJ 103□V	RoHS	10000		3.5			
35V	GMK105 BJ 104□V*1	RoHS	100000	B/X5R	5			
25V	TMK105 BJ 153□V	RoHS	15000	B/X5R*2	3.5	R	±10% ±20%	0.5±0.05 (0.02±0.002)
	TMK105 BJ 223□V	RoHS	22000					
	TMK105 BJ 333□V*1	RoHS	33000					
	TMK105 BJ 473□V*1	RoHS	47000					
	TMK105 BJ 104□V*1	RoHS	100000	B/X5R	5			
16V	EMK105 BJ 153□V	RoHS	15000	B/X5R*2	3.5	R	±10% ±20%	0.5±0.05 (0.02±0.002)
	EMK105 BJ 223□V	RoHS	22000					
	EMK105 BJ 333□V	RoHS	33000					
	EMK105 BJ 473□V	RoHS	47000					
	EMK105 BJ 683□V	RoHS	68000					
	EMK105 BJ 104□V*1	RoHS	100000					
	EMK105 BJ 224□V*1	RoHS	220000	B/X5R	5			
	EMK105 BJ 105□V*1	RoHS	1000000	X5R	10			
10V	LMK105 BJ 104□V	RoHS	100000	B/X5R	5	R	±10% ±20%	0.5±0.05 (0.02±0.002)
	LMK105 BJ 224□V*1	RoHS	220000					
	LMK105 BJ 474□V*1	RoHS	470000					
	LMK105 BJ 105□V*1	RoHS	1000000					
6.3V	JMK105 BJ 224□V*1	RoHS	220000	B/X5R	5	R	±10% ±20%	0.5±0.05 (0.02±0.002)
	JMK105 BJ 474□V*1	RoHS	470000					
	JMK105 BJ 105□V*1	RoHS	1000000					
	JMK105 BJ 225MV*1	RoHS	2200000					
4V	AMK105 BJ 335MV*1,*3	RoHS	3300000	X5R	10	R	±20%	0.5±0.1 (0.02±0.004)
	AMK105 BJ 475MV*1	RoHS	4700000					

□ Please specify the capacitance tolerance code.

\*1 1.5 times the rated voltage is applied to the chip during the high temperature loading test.

\*2 We may provide X7R for some items according to the individual specification.

\*3 The exchange of individual specification is necessary depending on the application and circuit condition. Please contact Taiyo Yuden sales channels.

\* This catalog contains the typical specification only due to the limitation of space. When you consider purchase of our products, please check our specification. For details of each product (characteristics graph, reliability information, precautions for use, and so on), see our Web site (<http://www.ty-top.com/>) or CD catalogs.

**PART NUMBERS**

[Temp.char. B7:X7R]

Rated Voltage	Ordering code		EHS (Environmental Hazardous Substances)	Capacitance [pF]	Temperature characteristics	Dissipation factor [%] Max.	Soldering method R:Reflow soldering W:Wave soldering	Capacitance tolerance	Thickness [mm] (inch)
50V	UMK105 B7 221□V		RoHS	220	X7R	2.5	R	±10% ±20%	0.5±0.05 (0.02±0.002)
	UMK105 B7 331□V		RoHS	330					
	UMK105 B7 471□V		RoHS	470					
	UMK105 B7 681□V		RoHS	680					
	UMK105 B7 102□V		RoHS	1000					
	UMK105 B7 152□V		RoHS	1500					
	UMK105 B7 222□V		RoHS	2200					
	UMK105 B7 332□V		RoHS	3300					
	UMK105 B7 472□V* <sup>1</sup>		RoHS	4700					
	UMK105 B7 682□V* <sup>1</sup>		RoHS	6800					
25V	TMK105 B7 103□V* <sup>1</sup>		RoHS	10000	X7R	2.5	R	±10% ±20%	0.5±0.05 (0.02±0.002)
	TMK105 B7 152□V		RoHS	1500					
	TMK105 B7 222□V		RoHS	2200					
	TMK105 B7 332□V		RoHS	3300					
	TMK105 B7 472□V		RoHS	4700					
16V	EMK105 B7 682□V		RoHS	6800	X7R	3.5	R	±10% ±20%	0.5±0.05 (0.02±0.002)
	EMK105 B7 103□V		RoHS	10000					
	EMK105 B7 223□V		RoHS	22000					
10V	EMK105 B7 473□V		RoHS	47000	X7R	5	R	±10% ±20%	0.5±0.05 (0.02±0.002)
	EMK105 B7 104□V* <sup>1</sup>		RoHS	100000					
	EMK105 B7 223□V		RoHS	22000					
6.3V	LMK105 B7 473□V		RoHS	47000	X7R	3.5	R	±10% ±20%	0.5±0.05 (0.02±0.002)
	LMK105 B7 104□V* <sup>1</sup>		RoHS	100000					
6.3V	JMK105 B7 224□V* <sup>1</sup>		RoHS	220000	X7R	5	R	±10% ±20%	0.5±0.05 (0.02±0.002)

□ Please specify the capacitance tolerance code.

\*1 1.5 times the rated voltage is applied to the chip during the high temperature loading test.

[Temp.char. F:Y5V]

Rated Voltage	Ordering code		EHS (Environmental Hazardous Substances)	Capacitance [pF]	Temperature characteristics	Dissipation factor [%] Max.	Soldering method R:Reflow soldering W:Wave soldering	Capacitance tolerance	Thickness [mm] (inch)
50V	UMK105 F103ZV		RoHS	10000	F/Y5V	5	R	+80% -20%	0.5±0.05 (0.02±0.002)
25V	TMK105 F223ZV		RoHS	22000					
16V	EMK105 F473ZV		RoHS	47000					
	EMK105 F104ZV		RoHS	100000					
10V	LMK105 F224ZV		RoHS	220000					
6.3V	JMK105 F474ZV		RoHS	470000					
	JMK105 F105ZV* <sup>1</sup>		RoHS	1000000					

\*1 1.5 times the rated voltage is applied to the chip during the high temperature loading test.

**CAPACITORS**

\* This catalog contains the typical specification only due to the limitation of space. When you consider purchase of our products, please check our specification.  
For details of each product (characteristics graph, reliability information, precautions for use, and so on), see our Web site (<http://www.ty-top.com/>) or CD catalogs.

# MULTILAYER CERAMIC CAPACITORS FOR HIGH FREQUENCY APPLICATIONS(1GHz+)



REFLOW

## FEATURES

- Q value in the high frequency range (1 GHz+) is superior compared to other types of multilayer capacitors.
- The 1005(0402) case size is designed for high density mounting and weight reduction in various applications.

## APPLICATIONS

- Suitable for those high frequency applications in which a capacitor with both a high Q-value and small size is required such as portable communications and other wireless applications. VCO, TCXO etc.
- Adjustment of characteristics in high frequency circuit

## ORDERING CODE

U | V | K | 1 | 0 | 5 | R | H | 4 | R | 3 | J | W | - | F

**1 Rated voltage (VDC)**

E	16
U	50

**2 Series name**

V	Multilayer ceramic capacitor for high frequency
---	---

**3 End termination**

K	Plated
---	--------

**4 Dimensions (EIA) (L×W) (mm)**

105(0402)	1.0×0.5
-----------	---------

**5 Temperature characteristics (ppm/°C)**

CH	0±60
RH	-220±60

**6 Nominal capacitance (pF)**

example	
020	2
4R3	4.3

※R=Decimal point

**7 Capacitance tolerance**

B	±0.1pF
J	±5%

**8 Thickness (mm)**

W	0.5
---	-----

**9 Special code**

-	Standard Product
---	------------------

**10 Packaging**

F	φ178mm Taping (2mm pitch)
---	---------------------------

## EXTERNAL DIMENSIONS/STANDARD QUANTITY

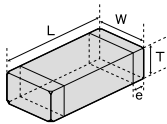

Type (EIA)	L	W	T	e	Standard quantity [pcs]	
					Paper tape	Embossed tape
□VK105 (0402)	1.0±0.05 (0.039±0.002)	0.5±0.05 (0.020±0.002)	0.5±0.05 (0.020±0.002)	0.25±0.1 (0.010±0.004)	10000	-

Unit : mm (inch)

## SPECIFICATIONS

Temperature Characteristics	Operating Temperature range	Temperature Coefficient range [ppm/°C]	Capacitance Tolerance
CH	-55~+125°C	0±60	±0.1pF (~2.0pF)
RH		-220±60	±5% (2.2pF~)

### Capacitance vs Q value (Typical for CH characteristic)

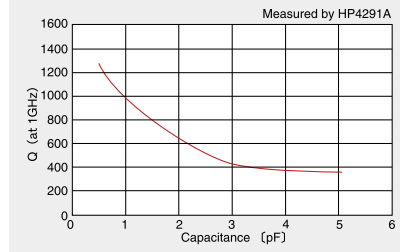

\* This catalog contains the typical specification only due to the limitation of space. When you consider purchase of our products, please check our specification. For details of each product (characteristics graph, reliability information, precautions for use, and so on), see our Web site (<http://www.ty-top.com/>) or CD catalogs.



**PART NUMBERS**

Rated Voltage (DC)	Ordering code	EHS (Environmental Hazardous Substances)	Temperature characteristics		Capacitance (pF)	Capacitance tolerance	Q (at 1GHz) (min.)	Thickness [mm]	Typical Q
			CH	RH					
E: 16V U: 50V	<input type="checkbox"/> VK105 CH0R3BW	RoHS	●		0.3	±0.1pF	300	0.5±0.05	1200
	<input type="checkbox"/> VK105 CH0R4BW	RoHS	●		0.4		300		1200
	<input type="checkbox"/> VK105 CH0R5BW	RoHS	●		0.5		300		1200
	<input type="checkbox"/> VK105 CH0R6BW	RoHS	●		0.6		300		1100
	<input type="checkbox"/> VK105 CH0R7BW	RoHS	●		0.7		300		1100
	<input type="checkbox"/> VK105 CH0R8BW	RoHS	●		0.8		300		1000
	<input type="checkbox"/> VK105 CH0R9BW	RoHS	●		0.9		300		950
	<input type="checkbox"/> VK105 CH010BW	RoHS	●		1.0		300		950
	<input type="checkbox"/> VK105 CH1R1BW	RoHS	●		1.1		280		930
	<input type="checkbox"/> VK105 CH1R2BW	RoHS	●		1.2		270		850
	<input type="checkbox"/> VK105 CH1R3BW	RoHS	●		1.3		260		740
	<input type="checkbox"/> VK105 CH1R5BW	RoHS	●		1.5		240		710
	<input type="checkbox"/> VK105 CH1R6BW	RoHS	●		1.6		230		670
	<input type="checkbox"/> VK105 CH1R8BW	RoHS	●		1.8		210		650
	<input type="checkbox"/> VK105 CH020BW	RoHS	●		2.0		190		610
	<input type="checkbox"/> VK105 CH2R2JW	RoHS	●		2.2	180	530		
	<input type="checkbox"/> VK105 CH2R4JW	RoHS	●		2.4	170	510		
	<input type="checkbox"/> VK105 CH2R7JW	RoHS	●		2.7	150	460		
	<input type="checkbox"/> VK105 CH030JW	RoHS	●		3.0	130	390		
	<input type="checkbox"/> VK105 CH3R3JW	RoHS	●		3.3	120	370		
	<input type="checkbox"/> VK105 CH3R6JW	RoHS	●		3.6	110	360		
	<input type="checkbox"/> VK105 CH3R9JW	RoHS	●		3.9	99	360		
	<input type="checkbox"/> VK105 CH4R3JW	RoHS	●		4.3	84	360		
	<input type="checkbox"/> VK105 CH4R7JW	RoHS	●		4.7	84	340		
	<input type="checkbox"/> VK105 CH5R1JW	RoHS	●		5.1	84	320		
	<input type="checkbox"/> VK105 RH0R5BW	RoHS		●	0.5	300	1100		
	<input type="checkbox"/> VK105 RH0R6BW	RoHS		●	0.6	300	1000		
	<input type="checkbox"/> VK105 RH0R7BW	RoHS		●	0.7	300	1000		
	<input type="checkbox"/> VK105 RH0R8BW	RoHS		●	0.8	300	970		
	<input type="checkbox"/> VK105 RH0R9BW	RoHS		●	0.9	300	950		
	<input type="checkbox"/> VK105 RH010BW	RoHS		●	1.0	300	900		
	<input type="checkbox"/> VK105 RH1R1BW	RoHS		●	1.1	280	900		
	<input type="checkbox"/> VK105 RH1R2BW	RoHS		●	1.2	270	740		
	<input type="checkbox"/> VK105 RH1R3BW	RoHS		●	1.3	260	700		
	<input type="checkbox"/> VK105 RH1R5BW	RoHS		●	1.5	240	680		
	<input type="checkbox"/> VK105 RH1R6BW	RoHS		●	1.6	230	640		
	<input type="checkbox"/> VK105 RH1R8BW	RoHS		●	1.8	210	620		
	<input type="checkbox"/> VK105 RH020BW	RoHS		●	2.0	190	570		
	<input type="checkbox"/> VK105 RH2R2JW	RoHS		●	2.2	180	480		
	<input type="checkbox"/> VK105 RH2R4JW	RoHS		●	2.4	170	470		
<input type="checkbox"/> VK105 RH2R7JW	RoHS		●	2.7	150	420			
<input type="checkbox"/> VK105 RH030JW	RoHS		●	3.0	130	360			
<input type="checkbox"/> VK105 RH3R3JW	RoHS		●	3.3	120	350			
<input type="checkbox"/> VK105 RH3R6JW	RoHS		●	3.6	110	340			
<input type="checkbox"/> VK105 RH3R9JW	RoHS		●	3.9	99	340			
<input type="checkbox"/> VK105 RH4R3JW	RoHS		●	4.3	84	340			
<input type="checkbox"/> VK105 RH4R7JW	RoHS		●	4.7	84	320			
<input type="checkbox"/> VK105 RH5R1JW	RoHS		●	5.1	84	310			

Please specify the Rated Voltage code.

CAPACITORS

\* This catalog contains the typical specification only due to the limitation of space. When you consider purchase of our products, please check our specification. For details of each product (characteristics graph, reliability information, precautions for use, and so on), see our Web site (<http://www.ty-top.com/>) or CD catalogs.

# SUPER LOW DISTORTION MULTILAYER CERAMIC CAPACITORS(CFCAP™)



REFLOW

## FEATURES

- Newly developed dielectric material and the use of nickel for internal electrodes provide superior temperature characteristics with high capacitance, small case size and low cost.
- Low distortion and low shock noise make these capacitors appropriate for use in analog or digital mobile devices.
- Superior heat-resistance, high breakdown voltage, and mechanical strength make these capacitors appropriate for replacing film capacitors.

## APPLICATIONS

- Signal line for AV products
- Analog signal coupling applications
- PLL circuit of mobile phones
- Good temperature characteristics for time constant circuits, oscillation circuits and filters

## ORDERING CODE

T M K 3 1 6 S D 1 0 4 K L - T △

**1** Rated voltage (VDC)

U	50
G	35
T	25
E	16
L	10
J	6.3

**2** Series name

M	Multilayer ceramic capacitor
---	------------------------------

**3** End termination

K	Plated
---	--------

**4** Dimensions (EIA) (L×W) (mm)

105 (0402)	1.0×0.5
107 (0603)	1.6×0.8
212 (0805)	2.0×1.25
316 (1206)	3.2×1.6

**5** Series symbol

SD	Standard
----	----------

**6** Nominal capacitance (μF)

example	
223	0.022
104	0.1

**7** Capacitance tolerance

K	±10%
---	------

**8** Thickness (mm)

P	0.3
V	0.5
A	0.8
D	0.85
F	1.15
G	1.25
L	1.6

**9** Special code

-	Standard Product
---	------------------

**10** Packaging

T	φ178mm Taping (4mm pitch) 107, 212, 316 Type
F	φ178mm Taping (2mm pitch) 105 Type

**11** Internal code

△	Standard Product
---	------------------

△=Blank space

## EXTERNAL DIMENSIONS/STANDARD QUANTITY

Type (EIA)	L	W	T		e	Standard quantity [pcs]	
						Paper tape	Embossed tape
□MK105 (0402)	1.0±0.05 (0.039±0.002)	0.5±0.05 (0.020±0.002)	0.3±0.03 (0.012±0.001)	P	0.25±0.10 (0.010±0.004)	10000	-
			0.5±0.05 (0.020±0.002)	V			
□MK107 (0603)	1.6±0.10 (0.063±0.004)	0.8±0.10 (0.031±0.004)	0.8±0.10 (0.031±0.004)	A	0.35±0.25 (0.014±0.010)	4000	-
			0.85±0.10 (0.033±0.004)	D			
□MK212 (0805)	2.0±0.10 (0.079±0.004)	1.25±0.10 (0.049±0.004)	1.25±0.10 (0.049±0.004)	G	0.5±0.25 (0.020±0.010)	-	3000
			1.15±0.10 (0.045±0.004)	F			
□MK316 (1206)	3.2±0.15 (0.126±0.006)	1.6±0.15 (0.063±0.006)	1.6±0.20 (0.063±0.008)	L	0.5 <sup>+0.35</sup> <sub>-0.25</sub> (0.020 <sup>+0.014</sup> <sub>-0.010</sub> )	-	3000
							2000

## AVAILABLE CAPACITANCE RANGE

Unit : mm (inch)

Cap [μF]	Type	105 SD						107 SD				212 SD				316 SD	
	Temp.Char	50V	25V	16V	10V	6.3V	50V	25V	16V	10V	50V	35V	16V	10V	35V	25V	
	VDC	[pF:3digits]															
0.00039	391	V															
0.00047	471	V															
0.00056	561	V															
0.00068	681		V														
0.00082	821		V														
0.001	102		V					A									
0.0012	122		V					A									
0.0015	152			V		P		A									
0.0018	182			V				A									
0.0022	222			V				A									
0.0027	272			V				A									
0.0033	332				V			A									
0.0039	392				V				A								
0.0047	472				V				A								
0.0056	562									A							
0.0068	682									A							
0.0082	822									A							
0.01	103									A							
0.012	123										A						
0.015	153											A					
0.018	183												A				
0.022	223													A			
0.027	273														A		
0.033	333															A	
0.039	393															A	
0.047	473															A	
0.056	563															A	
0.068	683															A	
0.082	823															A	
0.1	104															A	

※Letters in the table indicate thickness.

\* This catalog contains the typical specification only due to the limitation of space. When you consider purchase of our products, please check our specification. For details of each product (characteristics graph, reliability information, precautions for use, and so on), see our Web site (<http://www.ty-top.com/>) or CD catalogs.

## PART NUMBERS

### 105TYPE (0402 case size)

Rated Voltage	Ordering code	EHS (Environmental Hazardous Substances)	Capacitance [ $\mu$ F]	Temperature characteristics	Dissipation factor [%] Max.	Soldering method R:Reflow soldering W:Wave soldering	Capacitance tolerance	Thickness [mm] [inch]
50V	UMK105 SD391KV	RoHS	0.00039	Standard type	0.1	R	$\pm 10\%^*$	0.5 $\pm$ 0.05 (0.020 $\pm$ 0.002)
	UMK105 SD471KV	RoHS	0.00047					
	UMK105 SD561KV	RoHS	0.00056					
25V	TMK105 SD681KV	RoHS	0.00068					
	TMK105 SD821KV	RoHS	0.00082					
	TMK105 SD102KV	RoHS	0.0010					
16V	TMK105 SD122KV	RoHS	0.0012					
	EMK105 SD152KV	RoHS	0.0015					
	EMK105 SD182KV	RoHS	0.0018					
10V	EMK105 SD222KV	RoHS	0.0022					
	EMK105 SD272KV	RoHS	0.0027					
	LMK105 SD152KP	RoHS	0.0015					
6.3V	LMK105 SD332KV	RoHS	0.0033					
	LMK105 SD392KV	RoHS	0.0039					
	LMK105 SD472KV	RoHS	0.0047					
	JMK105 SD272KP	RoHS	0.0027					0.3 $\pm$ 0.03 (0.012 $\pm$ 0.001)

\*: Capacitance tolerance J ( $\pm 5\%$ ) is also available. Please contact Taiyo Yuden sales channels.

### 107TYPE (0603 case size)

Rated Voltage	Ordering code	EHS (Environmental Hazardous Substances)	Capacitance [ $\mu$ F]	Temperature characteristics	Dissipation factor [%] Max.	Soldering method R:Reflow soldering W:Wave soldering	Capacitance tolerance	Thickness [mm] [inch]
50V	UMK107 SD102KA	RoHS	0.0010	Standard type	0.1	R	$\pm 10\%^*$	0.8 $\pm$ 0.1 (0.031 $\pm$ 0.004)
	UMK107 SD122KA	RoHS	0.0012					
	UMK107 SD152KA	RoHS	0.0015					
	UMK107 SD182KA	RoHS	0.0018					
	UMK107 SD222KA	RoHS	0.0022					
	UMK107 SD272KA	RoHS	0.0027					
25V	UMK107 SD332KA	RoHS	0.0033					
	TMK107 SD392KA	RoHS	0.0039					
	TMK107 SD472KA	RoHS	0.0047					
16V	EMK107 SD562KA	RoHS	0.0056					
	EMK107 SD682KA	RoHS	0.0068					
	EMK107 SD822KA	RoHS	0.0082					
	EMK107 SD103KA	RoHS	0.010					
10V	LMK107 SD123KA	RoHS	0.012					
	LMK107 SD153KA	RoHS	0.015					
	LMK107 SD183KA	RoHS	0.018					
	LMK107 SD223KA	RoHS	0.022					

\*: Capacitance tolerance J ( $\pm 5\%$ ) is also available. Please contact Taiyo Yuden sales channels.

### 212TYPE (0805 case size)

Rated Voltage	Ordering code	EHS (Environmental Hazardous Substances)	Capacitance [ $\mu$ F]	Temperature characteristics	Dissipation factor [%] Max.	Soldering method R:Reflow soldering W:Wave soldering	Capacitance tolerance	Thickness [mm] [inch]
50V	UMK212 SD392KD	RoHS	0.0039	Standard type	0.1	R	$\pm 10\%^*$	0.85 $\pm$ 0.1 (0.033 $\pm$ 0.004)
	UMK212 SD472KD	RoHS	0.0047					
	UMK212 SD562KD	RoHS	0.0056					
	UMK212 SD682KD	RoHS	0.0068					
	UMK212 SD822KD	RoHS	0.0082					
	UMK212 SD103KD	RoHS	0.01					
35V	GМК212 SD123KD	RoHS	0.012					
	GМК212 SD153KD	RoHS	0.015					
	GМК212 SD183KG	RoHS	0.018					
	GМК212 SD223KG	RoHS	0.022					
16V	GМК212 SD273KG	RoHS	0.027					
	EMK212 SD333KD	RoHS	0.033					
10V	LMK212 SD473KD	RoHS	0.047					
	LMK212 SD683KG	RoHS	0.068					
	LMK212 SD823KG	RoHS	0.082					
	LMK212 SD104KG	RoHS	0.1					

\*: Capacitance tolerance J ( $\pm 5\%$ ) is also available. Please contact Taiyo Yuden sales channels.

### 316TYPE (1206 case size)

Rated Voltage	Ordering code	EHS (Environmental Hazardous Substances)	Capacitance [ $\mu$ F]	Temperature characteristics	Dissipation factor [%] Max.	Soldering method R:Reflow soldering W:Wave soldering	Capacitance tolerance	Thickness [mm] [inch]
35V	GМК316 SD333KF	RoHS	0.033	Standard type	0.1	R	$\pm 10\%^*$	1.15 $\pm$ 0.1 (0.045 $\pm$ 0.004)
	GМК316 SD393KF	RoHS	0.039					
25V	TMK316 SD473KF	RoHS	0.047					
	TMK316 SD563KF	RoHS	0.056					
	TMK316 SD683KF	RoHS	0.068					
	TMK316 SD823KL	RoHS	0.082					
	TMK316 SD104KL	RoHS	0.1					

\*: Capacitance tolerance J ( $\pm 5\%$ ) is also available. Please contact Taiyo Yuden sales channels.

\* This catalog contains the typical specification only due to the limitation of space. When you consider purchase of our products, please check our specification.  
For details of each product (characteristics graph, reliability information, precautions for use, and so on), see our Web site (<http://www.ty-top.com/>) or CD catalogs.

Capacitance-temperature characteristics

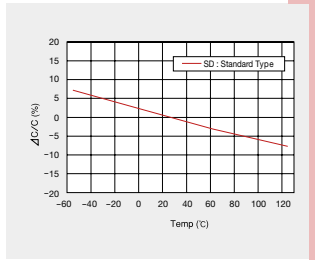

\* This catalog contains the typical specification only due to the limitation of space. When you consider purchase of our products, please check our specification.  
For details of each product (characteristics graph, reliability information, precautions for use, and so on), see our Web site (<http://www.ty-top.com/>) or CD catalogs.

Multilayer Ceramic Capacitors and Medium-High Voltage Multilayer Ceramic Capacitors are noted separately.

Super Low Distortion Multilayer Ceramic Capacitors (CFCAP)

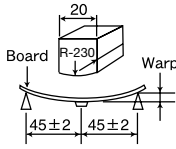
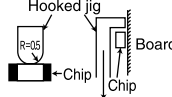
<b>1. Operating Temperature Range</b>												
Specified Value	-55 to +125°C											
<b>2. Storage Temperature Range</b>												
Specified Value	-55 to +125°C											
<b>3. Rated Voltage</b>												
Specified Value	6.3VDC, 10VDC, 16VDC, 25VDC, 35VDC, 50VDC											
<b>4. Withstanding Voltage (Between terminals)</b>												
Specified Value	No breakdown or damage											
[Test Methods and Remarks] Applied voltage: Rated voltage×3 Duration: 1 to 5 sec. Charge/discharge current: 50mA max.												
<b>5. Insulation Resistance</b>												
Specified Value	10000 MΩ or 500MΩ μF, whichever is smaller											
[Test Methods and Remarks] Applied voltage: Rated voltage Duration: 60±5 sec. Charge/discharge current: 50mA max.												
<b>6. Capacitance (Tolerance)</b>												
Specified Value	±10%											
[Test Methods and Remarks] Measuring frequency : 1kHz±10% Measuring voltage : 1±0.2Vrms Bias application: None												
<b>7. Dissipation Factor</b>												
Specified Value	0.1%max											
[Test Methods and Remarks] Measuring frequency : 1kHz±10% Measuring voltage : 1±0.2Vrms Bias application: None												
<b>8. Deflection</b>												
Specified Value	Appearance: No abnormality Capacitance change: ±5%											
[Test Methods and Remarks] Warp: 1mm Speed: 0.5mm/second Duration:10 seconds Test board: glass epoxy resin substrate Thickness: 1.6mm Capacitance measurement shall be conducted with the board bent.												
 <p style="text-align: center;">(Unit: mm)</p>												
<b>9. Adhesive Strength of Terminal Electrodes</b>												
Specified Value	No terminal separation or its indication.											
[Test Methods and Remarks] Applied force: 5N Duration: 30 ±5 seconds												
												
<b>10. Solderability</b>												
Specified Value	At least 95% of terminal electrode is covered by new solder.											
[Test Methods and Remarks]												
	<table border="1"> <thead> <tr> <th></th> <th>Solder type</th> <th>Solder temperature</th> <th>Duration</th> </tr> </thead> <tbody> <tr> <td>Eutectic solder</td> <td>H60A or H63A</td> <td>230±5°C</td> <td rowspan="2">4±1 sec.</td> </tr> <tr> <td>Lead-free solder</td> <td>Sn-3.0Ag-0.5Cu</td> <td>245±3°C</td> </tr> </tbody> </table>		Solder type	Solder temperature	Duration	Eutectic solder	H60A or H63A	230±5°C	4±1 sec.	Lead-free solder	Sn-3.0Ag-0.5Cu	245±3°C
	Solder type	Solder temperature	Duration									
Eutectic solder	H60A or H63A	230±5°C	4±1 sec.									
Lead-free solder	Sn-3.0Ag-0.5Cu	245±3°C										
<b>11. Resistance to Soldering</b>												
Specified Value	Appearance: No abnormality Capacitance change: ±2.5% max. Dissipation factor : Initial value Insulation resistance: Initial value Withstanding voltage (between terminals): No abnormality											
[Test Methods and Remarks] Solder temp.: 270 ±5°C Duration: 3 ±0.5 sec. Preheating conditions : 80 to 100°C, 2 to 5 min. or 5 to 10 min. 150 to 200°C, 2 to 5 min. or 5 to 10 min. Recovery : 24±2hrs under the standard condition Note1												

\* This catalog contains the typical specification only due to the limitation of space. When you consider purchase of our products, please check our specification. For details of each product (characteristics graph, reliability information, precautions for use, and so on), see our Web site (<http://www.ty-top.com/>) or CD catalogs.

## RELIABILITY DATA

### 12. Temperature Cycle (Thermal Shock)

Specified Value	Appearance: No abnormality Capacitance change: $\pm 2.5\%$ max Dissipation factor : Initial value Insulation resistance: Initial value Withstanding voltage (between terminals): No abnormality
-----------------	---

#### [Test Methods and Remarks]

Conditions for 1 cycle / Step 1: Minimum operating temperature  $\pm 3^{\circ}\text{C}$  30 $\pm$ 3 min.  
Step 2: Room temperature 2 to 3 min.  
Step 3: Maximum operating temperature  $\pm 3^{\circ}\text{C}$  30 $\pm$ 3 min.  
Step 4: Room temperature 2 to 3 min.

Number of cycles: 5 times

Recovery : 24 $\pm$ 2hrs under the standard condition Note1

### 13. Humidity (Steady state)

Specified Value	Appearance: No abnormality Capacitance change: $\pm 5\%$ max Dissipation factor : 0.5% max Insulation resistance 50M $\Omega$ $\mu$ F or 1000M $\Omega$ , whichever is smaller
-----------------	---

#### [Test Methods and Remarks]

Temperature: 40 $\pm$ 2 $^{\circ}\text{C}$

Humidity: 90 to 95% RH

Duration: 500  $\pm_{-0}^{+24}$  hrs

Recovery: 24  $\pm$ 2hrs under the standard condition Note1

### 14. Humidity Loading

Specified Value	Appearance: No abnormality Capacitance change: $\pm 7.5\%$ max Dissipation factor : 0.5% max Insulation resistance: 25M $\Omega$ $\mu$ F or 500M $\Omega$ , whichever is smaller
-----------------	---

#### [Test Methods and Remarks]

According to JIS C 5102 clause 9.9.

Temperature: 40 $\pm$ 2 $^{\circ}\text{C}$  Humidity: 90 to 95% RH

Duration: 500  $\pm_{-0}^{+24}$  hrs

Applied voltage: Rated voltage

Charge/discharge current: 50mA max

Recovery: 24  $\pm$ 2hrs under the standard condition Note1

### 15. High Temperature Loading

Specified Value	Appearance: No abnormality Capacitance change: $\pm 3\%$ max Dissipation factor : 0.35% max Insulation resistance: 50M $\Omega$ $\mu$ F or 1000M $\Omega$ , whichever is smaller
-----------------	---

#### [Test Methods and Remarks]

According to JIS C 5102 clause 9.10.

Temperature: 125 $\pm$ 3 $^{\circ}\text{C}$

Duration: 1000  $\pm_{-0}^{+48}$  hrs

Applied voltage: Rated voltage x 2

Charge/discharge current: 50mA max

Recovery: 24  $\pm$ 2hrs under the standard condition Note1

Note1 Standard condition: Temperature: 5 to 35 $^{\circ}\text{C}$ , Relative humidity: 45 to 85 % RH, Air pressure: 86 to 106kPa  
When there are questions concerning measurement results, in order to provide correlation data, the test shall be conducted under the following condition.  
Temperature: 20 $\pm$ 2 $^{\circ}\text{C}$ , Relative humidity: 60 to 70 % RH, Air pressure: 86 to 106kPa  
Unless otherwise specified, all the tests are conducted under the "standard condition".

\* This catalog contains the typical specification only due to the limitation of space. When you consider purchase of our products, please check our specification.  
For details of each product (characteristics graph, reliability information, precautions for use, and so on), see our Web site (<http://www.ty-top.com/>) or CD catalogs.

# MEDIUM-HIGH VOLTAGE MULTILAYER CERAMIC CAPACITORS



REFLOW

## FEATURES

- The use of nickel as electrode material prevents migration and provides high reliability.
- Small case sizes with high rated voltage.

## APPLICATIONS

- General telephone exchange
- Inverter
- Wireless and Telecommunication base
- For DC/DC Converter

## ORDERING CODE

H | M | K | 3 | 1 | 6 | B | J | 1 | 0 | 4 | K | L | - | T | △

**1** Rated voltage [VDC]

H	100
Q	250
S	630

**2** Series name

M	Multilayer ceramic capacitor
---	------------------------------

**3** End termination

K	Plated
---	--------

**4** Dimensions (EIA) L×W (mm)

107 (0603)	1.6×0.8
212 (0805)	2.0×1.25
316 (1206)	3.2×1.6
325 (1210)	3.2×2.5
432 (1812)	4.5×3.2

**5** Temperature characteristics code

BJ	B
	X5R
B7	X7R
C7	X7S

**6** Nominal capacitance [pF]

example	
104	100,000
105	1,000,000

**7** Capacitance tolerance

K	±10%
M	±20%

**8** Thickness (mm)

A	0.8
D	0.85
G	1.25
F	1.15
L	1.6
N	1.9
M	2.5

**9** Special code

-	Standard Product
---	------------------

**10** Packaging

T	φ178mm Taping (4mm pitch)
---	---------------------------

**11** Internal code

△	Standard Product
---	------------------

△=Blank space

## EXTERNAL DIMENSIONS/STANDARD QUANTITY

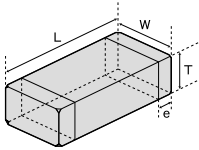

Type (EIA)	L	W	T		e	Standard quantity [pcs]	
						Paper tape	Embossed tape
□MK107 (0603)	1.6±0.10 (0.063±0.004)	0.8±0.10 (0.031±0.004)	0.8±0.10 (0.031±0.004)	A	0.35±0.25 (0.014±0.010)	4000	-
□MK212 (0805)	2.0±0.10 (0.079±0.004)	1.25±0.10 (0.049±0.004)	0.85±0.10 (0.033±0.004)	D	0.5±0.25 (0.020±0.010)	4000	-
			1.25±0.10 (0.049±0.004)	G		-	3000
□MK316 (1206)	3.2±0.15 (0.126±0.006)	1.6±0.15 (0.063±0.006)	1.15±0.10 (0.045±0.004)	F	0.5 <sup>+0.35</sup> <sub>-0.25</sub> (0.020 <sup>+0.014</sup> <sub>-0.010</sub> )	-	3000
			1.6±0.20 (0.063±0.008)	L		-	2000
□MK325 (1210)	3.2±0.3 (0.126±0.012)	2.5±0.20 (0.098±0.008)	1.15±0.10 (0.045±0.004)	F	0.6±0.3 (0.024±0.012)	-	2000
			1.9±0.20 (0.075±0.008)	N		-	
□MK432 (1812)	4.5±0.4 (0.177±0.016)	3.2±0.30 (0.126±0.012)	2.5±0.20 (0.098±0.008)	M	0.9±0.6 (0.035±0.024)	-	500

Unit : mm (inch)

## AVAILABLE CAPACITANCE RANGE

Cap [μF]	Type	107			212		316				325			432										
		Temp. Char VDC			X7R	B/X5R	X7R	B/X5R	X7R	B/X5R	X7R	B/X5R	X7R	B/X5R	X7R	B/X5R	X7R	B/X5R						
		100V	100V	100V	100V	250V	100V	250V	100V	250V	630V	100V	250V	630V	100V	250V	630V	100V	250V	630V	100V	250V	630V	
0.001	102	A		A		D		D		F		F												
0.0015	152	A		A		D		D		F		F												
0.0022	222	A		A		D		D		F		F												
0.0033	332	A		A		D		D		F		F												
0.0047	472	A		A		G		G		F		F												
0.0068	682	A		A		G		G		F		F												
0.01	103	A		A		G		G		F		F												
0.015	153	A		A		G		G		L		L												
0.022	223	A		A		G		G		L		L				N				N				
0.033	333	A		A		G		G		L		L				N				N				
0.047	473					G		G		L		L				N				N				
0.068	683					G		G		L		L				N				N				
0.1	104		A	A		G		G		L		L				F			F					
0.15	154					G		G		L		L				N			N					
0.22	224					G		G		L		L				N			N					
0.33	334									L		L				N			N					
0.47	474									L		L				N			N					
0.68	684															N			N					
1.0	105															N			N					
1.5	155																			M				
2.2	225																			M				

※Letters in the table indicate thickness.

\* This catalog contains the typical specification only due to the limitation of space. When you consider purchase of our products, please check our specification. For details of each product (characteristics graph, reliability information, precautions for use, and so on), see our Web site (<http://www.ty-top.com/>) or CD catalogs.

■ AVAILABLE CAPACITANCE RANGE

Temp.char.Code	Temperature characteristics					Capacitance tolerance [%]
	Applicable standard		Temperature range [°C]	Ref. Temp. [°C]	Capacitance change [%]	
BJ	JIS	B	-25~+85	20	±10	±10 (K) ±20 (M)
	EIA	X5R	-55~+85	25	±15	
B7	EIA	X7R	-55~+125	25	±15	
C7	EIA	X7S	-55~+125	25	±22	

■ PART NUMBERS

● 107TYPE (0603 case size)

[Temp.char. BJ:B/X5R]

Rated Voltage	Ordering code	EHS (Environmental Hazardous Substances)	Capacitance (μF)	Temperature characteristics	Dissipation factor [%] Max.	Soldering method R:Reflow soldering W:Wave soldering	Capacitance tolerance	Thickness [mm] (inch)
100V	HMK107 BJ102□A	RoHS	0.001	B/X5R <sup>2</sup>	3.5	R	±10% ±20%	0.8±0.1 (0.031±0.0041)
	HMK107 BJ152□A	RoHS	0.0015					
	HMK107 BJ222□A	RoHS	0.0022					
	HMK107 BJ332□A	RoHS	0.0033					
	HMK107 BJ472□A	RoHS	0.0047					
	HMK107 BJ682□A	RoHS	0.0068					
	HMK107 BJ103□A	RoHS	0.01					
	HMK107 BJ153□A	RoHS	0.015					
	HMK107 BJ223□A	RoHS	0.022					
	HMK107 BJ333□A	RoHS	0.033					
HMK107 BJ104□A	RoHS	0.1						

□ Please specify the capacitance tolerance code.

\*2 : We may provide X7R/X7S for some items according to the individual specification.

[Temp.char. B7:X7R C7:X7S]

Rated Voltage	Ordering code	EHS (Environmental Hazardous Substances)	Capacitance (μF)	Temperature characteristics	Dissipation factor [%] Max.	Soldering method R:Reflow soldering W:Wave soldering	Capacitance tolerance	Thickness [mm] (inch)
100V	HMK107 B7 102□A	RoHS	0.001	X7R	3.5	R	±10% ±20%	0.8±0.1 (0.031±0.0041)
	HMK107 B7 152□A	RoHS	0.0015					
	HMK107 B7 222□A	RoHS	0.0022					
	HMK107 B7 332□A	RoHS	0.0033					
	HMK107 B7 472□A	RoHS	0.0047					
	HMK107 B7 682□A	RoHS	0.0068					
	HMK107 B7 103□A	RoHS	0.01					
	HMK107 B7 153□A	RoHS	0.015					
	HMK107 B7 223□A	RoHS	0.022					
	HMK107 B7 333□A	RoHS	0.033					
HMK107 C7 104□A	RoHS	0.1	X7S					

□ Please specify the capacitance tolerance code.

● 212TYPE (0805 case size)

[Temp.char. BJ:B/X5R]

Rated Voltage	Ordering code	EHS (Environmental Hazardous Substances)	Capacitance (μF)	Temperature characteristics	Dissipation factor [%] Max.	Soldering method R:Reflow soldering W:Wave soldering	Capacitance tolerance	Thickness [mm] (inch)			
100V	HMK212 BJ103□G	RoHS	0.01	B/X5R <sup>2</sup>	3.5	R	±10% ±20%	1.25±0.1 (0.049±0.004)			
	HMK212 BJ153□G	RoHS	0.015								
	HMK212 BJ223□G	RoHS	0.022								
	HMK212 BJ333□G	RoHS	0.033								
	HMK212 BJ473□G	RoHS	0.047								
	HMK212 BJ683□G	RoHS	0.068								
	HMK212 BJ104□G	RoHS	0.1								
250V	HMK212 BJ224□G	RoHS	0.22		2.5			2.5	R	±10% ±20%	0.85±0.1 (0.033±0.004)
	QMK212 BJ102□D	RoHS	0.001								
	QMK212 BJ152□D	RoHS	0.0015								
	QMK212 BJ222□D	RoHS	0.0022								
	QMK212 BJ332□D	RoHS	0.0033								
	QMK212 BJ472□G	RoHS	0.0047								
	QMK212 BJ682□G	RoHS	0.0068								
QMK212 BJ103□G	RoHS	0.01									
QMK212 BJ153□G	RoHS	0.015									
QMK212 BJ223□G	RoHS	0.022									

□ Please specify the capacitance tolerance code.

\*2 : We may provide X7R for some items according to the individual specification.

\* This catalog contains the typical specification only due to the limitation of space. When you consider purchase of our products, please check our specification. For details of each product (characteristics graph, reliability information, precautions for use, and so on), see our Web site (<http://www.ty-top.com/>) or CD catalogs.



## PART NUMBERS

[Temp.char. B7:X7R]

Rated Voltage	Ordering code	EHS (Environmental Hazardous Substances)	Capacitance [μF]	Temperature characteristics	Dissipation factor [%] Max.	Soldering method R:Reflow soldering W:Wave soldering	Capacitance tolerance	Thickness [mm] (inch)
100V	HMK212 B7 103□G	RoHS	0.01	X7R	3.5	R	±10% ±20%	1.25±0.1 (0.049±0.004)
	HMK212 B7 153□G	RoHS	0.015					
	HMK212 B7 223□G	RoHS	0.022					
	HMK212 B7 333□G	RoHS	0.033					
	HMK212 B7 473□G	RoHS	0.047					
	HMK212 B7 683□G	RoHS	0.068					
	HMK212 B7 104□G	RoHS	0.1					
250V	HMK212 B7 224□G	RoHS	0.22					
	QMK212 B7 102□D	RoHS	0.001					
	QMK212 B7 152□D	RoHS	0.0015					
	QMK212 B7 222□D	RoHS	0.0022					
	QMK212 B7 332□D	RoHS	0.0033					
	QMK212 B7 472□G	RoHS	0.0047					
	QMK212 B7 682□G	RoHS	0.0068					
250V	QMK212 B7 103□G	RoHS	0.01					
	QMK212 B7 153□G	RoHS	0.015					
	QMK212 B7 223□G	RoHS	0.022					
	QMK212 B7 223□G	RoHS	0.022					

□ Please specify the capacitance tolerance code.

## ●316TYPE(1206 case size)

[Temp.char. BJ:B/X5R]

Rated Voltage	Ordering code	EHS (Environmental Hazardous Substances)	Capacitance [μF]	Temperature characteristics	Dissipation factor [%] Max.	Soldering method R:Reflow soldering W:Wave soldering	Capacitance tolerance	Thickness [mm] (inch)
100V	HMK316 BJ473□L	RoHS	0.047	B/X5R*2	3.5	R	±10% ±20%	1.6±0.2 (0.063±0.008)
	HMK316 BJ683□L	RoHS	0.068					
	HMK316 BJ104□L	RoHS	0.1					
	HMK316 BJ154□L	RoHS	0.15					
	HMK316 BJ224□L	RoHS	0.22					
	HMK316 BJ334□L	RoHS	0.33					
	HMK316 BJ474□L	RoHS	0.47					
250V	HMK316 BJ105□L	RoHS	1					
	QMK316 BJ333□L	RoHS	0.033					
	QMK316 BJ473□L	RoHS	0.047					
	QMK316 BJ683□L	RoHS	0.068					
630V	QMK316 BJ104□L	RoHS	0.1					
	SMK316 BJ102□F	RoHS	0.001					
	SMK316 BJ152□F	RoHS	0.0015					
	SMK316 BJ222□F	RoHS	0.0022					
	SMK316 BJ332□F	RoHS	0.0033					
	SMK316 BJ472□F	RoHS	0.0047					
	SMK316 BJ682□F	RoHS	0.0068					
	SMK316 BJ103□F	RoHS	0.01					
	SMK316 BJ153□L	RoHS	0.015					
SMK316 BJ223□L	RoHS	0.022						

□ Please specify the capacitance tolerance code.

\*2 : We may provide X7R for some items according to the individual specification.

[Temp.char. B7:X7R]

Rated Voltage	Ordering code	EHS (Environmental Hazardous Substances)	Capacitance [μF]	Temperature characteristics	Dissipation factor [%] Max.	Soldering method R:Reflow soldering W:Wave soldering	Capacitance tolerance	Thickness [mm] (inch)
100V	HMK316 B7 473□L	RoHS	0.047	X7R	3.5	R	±10% ±20%	1.6±0.2 (0.063±0.008)
	HMK316 B7 683□L	RoHS	0.068					
	HMK316 B7 104□L	RoHS	0.1					
	HMK316 B7 154□L	RoHS	0.15					
	HMK316 B7 224□L	RoHS	0.22					
	HMK316 B7 334□L	RoHS	0.33					
	HMK316 B7 474□L	RoHS	0.47					
250V	HMK316 B7 105□L	RoHS	1					
	QMK316 B7 333□L	RoHS	0.033					
	QMK316 B7 473□L	RoHS	0.047					
	QMK316 B7 683□L	RoHS	0.068					
630V	QMK316 B7 104□L	RoHS	0.1					
	SMK316 B7 102□F	RoHS	0.001					
	SMK316 B7 152□F	RoHS	0.0015					
	SMK316 B7 222□F	RoHS	0.0022					
	SMK316 B7 332□F	RoHS	0.0033					
	SMK316 B7 472□F	RoHS	0.0047					
	SMK316 B7 682□F	RoHS	0.0068					
	SMK316 B7 103□F	RoHS	0.01					
	SMK316 B7 153□L	RoHS	0.015					
SMK316 B7 223□L	RoHS	0.022						

□ Please specify the capacitance tolerance code.

\* This catalog contains the typical specification only due to the limitation of space. When you consider purchase of our products, please check our specification.  
For details of each product (characteristics graph, reliability information, precautions for use, and so on), see our Web site (<http://www.ty-top.com/>) or CD catalogs.

**PART NUMBERS**

**325TYPE (1210 case size)**

[Temp.char. BJ:B/X5R]

Rated Voltage	Ordering code	EHS (Environmental Hazardous Substances)	Capacitance (μF)	Temperature characteristics	Dissipation factor (%) Max.	Soldering method R:Reflow soldering W:Wave soldering	Capacitance tolerance	Thickness (mm) (inch)			
100V	HMK325 BJ104□F	RoHS	0.1	B/X5R <sup>2</sup>	3.5	R	±10% ±20%	1.15±0.1 (0.045±0.004)			
	HMK325 BJ154□N	RoHS	0.15								
	HMK325 BJ224□N	RoHS	0.22								
	HMK325 BJ334□N	RoHS	0.33								
	HMK325 BJ474□N	RoHS	0.47								
	HMK325 BJ684□N	RoHS	0.68								
	HMK325 BJ105□N	RoHS	1								
HMK325 BJ225□N	RoHS	2.2									
250V	QMK325 BJ473□N	RoHS	0.047		2.5			2.5	R	±10% ±20%	1.9±0.2 (0.075±0.008)
	QMK325 BJ104□N	RoHS	0.1								
	QMK325 BJ154□N	RoHS	0.15								
	QMK325 BJ224□N	RoHS	0.22								
630V	SMK325 BJ223□N	RoHS	0.022		0.047			0.022	RoHS	0.033	0.047
	SMK325 BJ333□N	RoHS	0.033								
	SMK325 BJ473□N	RoHS	0.047								

□ Please specify the capacitance tolerance code.

\*2 : We may provide X7R for some items according to the individual specification.

[Temp.char. B7:X7R]

Rated Voltage	Ordering code	EHS (Environmental Hazardous Substances)	Capacitance (μF)	Temperature characteristics	Dissipation factor (%) Max.	Soldering method R:Reflow soldering W:Wave soldering	Capacitance tolerance	Thickness (mm) (inch)			
100V	HMK325 B7 104□F	RoHS	0.1	X7R	3.5	R	±10% ±20%	1.15±0.1 (0.045±0.004)			
	HMK325 B7 154□N	RoHS	0.15								
	HMK325 B7 224□N	RoHS	0.22								
	HMK325 B7 334□N	RoHS	0.33								
	HMK325 B7 474□N	RoHS	0.47								
	HMK325 B7 684□N	RoHS	0.68								
	HMK325 B7 105□N	RoHS	1								
HMK325 B7 225□N	RoHS	2.2									
250V	QMK325 B7 473□N	RoHS	0.047		2.5			2.5	R	±10% ±20%	1.9±0.2 (0.075±0.008)
	QMK325 B7 104□N	RoHS	0.1								
	QMK325 B7 154□N	RoHS	0.15								
	QMK325 B7 224□N	RoHS	0.22								
630V	SMK325 B7 223□N	RoHS	0.022		0.047			0.022	RoHS	0.033	0.047
	SMK325 B7 333□N	RoHS	0.033								
	SMK325 B7 473□N	RoHS	0.047								

□ Please specify the capacitance tolerance code.

**432TYPE (1812 case size)**

[Temp.char. BJ:B/X5R]

Rated Voltage	Ordering code	EHS (Environmental Hazardous Substances)	Capacitance (μF)	Temperature characteristics	tan δ Dissipation factor (%) Max.	Soldering method R:Reflow soldering W:Wave soldering	Capacitance tolerance	Thickness (mm) (inch)				
100V	HMK432 BJ474□M	RoHS	0.47	B/X5R <sup>2</sup>	3.5	R	±10% ±20%	2.5±0.2 (0.098±0.008)				
	HMK432 BJ105□M	RoHS	1									
	HMK432 BJ155□M	RoHS	1.5									
	HMK432 BJ225□M	RoHS	2.2									
250V	QMK432 BJ104□M	RoHS	0.1		2.5				2.5	R	±10% ±20%	2.5±0.2 (0.098±0.008)
	QMK432 BJ224□M	RoHS	0.22									
	QMK432 BJ334□M	RoHS	0.33									
	QMK432 BJ474□M	RoHS	0.47									
630V	SMK432 BJ473□M	RoHS	0.047		0.1				0.068	RoHS	0.1	0.1
	SMK432 BJ683□M	RoHS	0.068									
	SMK432 BJ104□M	RoHS	0.1									

□ Please specify the capacitance tolerance code.

\*2 : We may provide X7R for some items according to the individual specification.

[Temp.char. B7:X7R]

Rated Voltage	Ordering code	EHS (Environmental Hazardous Substances)	Capacitance (μF)	Temperature characteristics	Dissipation factor (%) Max.	Soldering method R:Reflow soldering W:Wave soldering	Capacitance tolerance	Thickness (mm) (inch)				
100V	HMK432 B7 474□M	RoHS	0.47	X7R	3.5	R	±10% ±20%	2.5±0.2 (0.098±0.008)				
	HMK432 B7 105□M	RoHS	1									
	HMK432 B7 155□M	RoHS	1.5									
	HMK432 B7 225□M	RoHS	2.2									
250V	QMK432 B7 104□M	RoHS	0.1		2.5				2.5	R	±10% ±20%	2.5±0.2 (0.098±0.008)
	QMK432 B7 224□M	RoHS	0.22									
	QMK432 B7 334□M	RoHS	0.33									
	QMK432 B7 474□M	RoHS	0.47									
630V	SMK432 B7 473□M	RoHS	0.047		0.1				0.068	RoHS	0.1	0.1
	SMK432 B7 683□M	RoHS	0.068									
	SMK432 B7 104□M	RoHS	0.1									

□ Please specify the capacitance tolerance code.

\* This catalog contains the typical specification only due to the limitation of space. When you consider purchase of our products, please check our specification. For details of each product (characteristics graph, reliability information, precautions for use, and so on), see our Web site (<http://www.ty-top.com/>) or CD catalogs.



## ELECTRICAL CHARACTERISTICS

### ● Example of Impedance ESR vs. Frequency characteristics

#### ■ Taiyo Yuden medium-high voltage ceramic capacitor

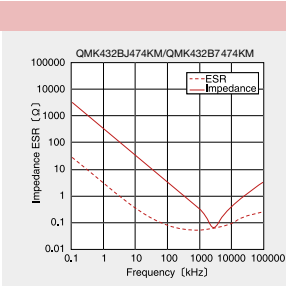
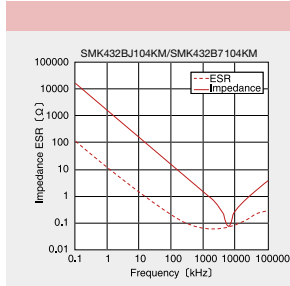
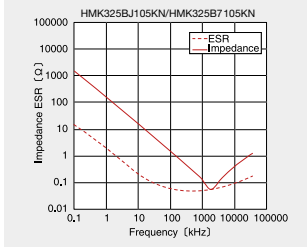
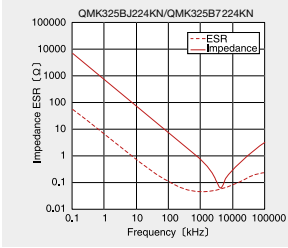
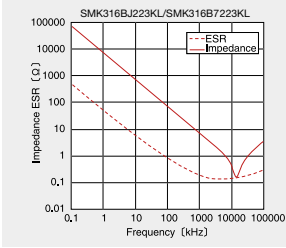
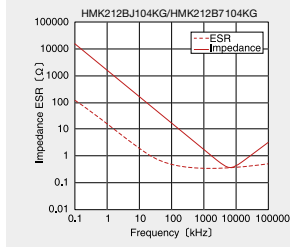

### ● Temperature characteristics

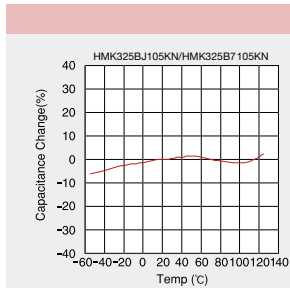

\* This catalog contains the typical specification only due to the limitation of space. When you consider purchase of our products, please check our specification. For details of each product (characteristics graph, reliability information, precautions for use, and so on), see our Web site (<http://www.ty-top.com/>) or CD catalogs.

Multilayer Ceramic Capacitors and Super Low Distortion Multilayer Ceramic Capacitors are noted separately.

Medium – High Voltage Multilayer Ceramic Capacitor

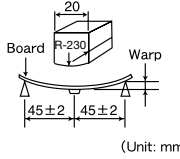
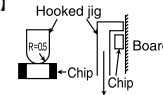
<b>1. Operating Temperature Range</b>													
Specified Value	X7R, X7S : -55~+125°C X5R : -55~+85°C B : -25~+85°C												
<b>2. Storage Temperature Range</b>													
Specified Value	X7R, X7S : -55~+125°C X5R : -55~+85°C B : -25~+85°C												
<b>3. Rated Voltage</b>													
Specified Value	100VDC, 250VDC, 630VDC												
<b>4. Withstanding Voltage (Between terminals)</b>													
Specified Value	No breakdown or damage												
[Test Methods and Remarks] Applied voltage: Rated voltage×2.5 (HMK), Rated voltage×2 (QMK), Rated voltage×1.2 (SMK) Duration : 1 to 5sec. Charge/discharge current : 50mA max.													
<b>5. Insulation Resistance</b>													
Specified Value	100MΩμF or 10GΩ, whichever is smaller.												
[Test Methods and Remarks] Applied voltage: Rated voltage (HMK, QMK), 500V (SMK) Duration : 60±5sec. Charge/discharge current : 50mA max.													
<b>6. Capacitance (Tolerance)</b>													
Specified Value	±10%, ±20%												
[Test Methods and Remarks] Measuring frequency: 1kHz±10% Measuring voltage: 1±0.2Vrms Bias application: None													
<b>7. Dissipation Factor</b>													
Specified Value	3.5% max (HMK) 2.5% max (QMK, SMK)												
[Test Methods and Remarks] Measuring frequency: 1kHz±10% Measuring voltage: 1±0.2Vrms Bias application: None													
<b>8. Temperature Characteristic of Capacitance</b>													
Specified Value	B : ±10% (-25~+85°C) X5R : ±15% (-55~+85°C) X7R : ±15% (-55~+125°C) X7S : ±22% (-55~+125°C)												
[Test Methods and Remarks] Capacitance value at each step shall be measured in thermal equilibrium, and the temperature characteristic shall be calculated from the following equation.													
<table border="1"> <thead> <tr> <th>Step</th> <th>B</th> <th>X5R, X7R, X7S</th> </tr> </thead> <tbody> <tr> <td>1</td> <td colspan="2">Minimum operating temperature</td> </tr> <tr> <td>2</td> <td>20°C</td> <td>25°C</td> </tr> <tr> <td>3</td> <td colspan="2">Maximum operating temperature</td> </tr> </tbody> </table>	Step	B	X5R, X7R, X7S	1	Minimum operating temperature		2	20°C	25°C	3	Maximum operating temperature		$\frac{(C_1 - C_2)}{C_2} \times 100 (\%)$ <p>C<sub>1</sub> : Capacitance value in Step 1 or Step 3 C<sub>2</sub> : Capacitance value in Step 2</p>
Step	B	X5R, X7R, X7S											
1	Minimum operating temperature												
2	20°C	25°C											
3	Maximum operating temperature												
<b>9. Deflection</b>													
Specified Value	Appearance: No abnormality Capacitance change: Within ±10%												
[Test Methods and Remarks] Warp: 1mm Duration: 10sec. Test board: glass epoxy-resin substrate Thickness: 1.6mm Capacitance measurement shall be conducted with the board bent.													
													
<b>10. Adhesive Strength of Terminal Electrodes</b>													
Specified Value	No terminal separation or its indication.												
[Test Methods and Remarks] Applied force: 5N Duration: 30±5sec.													
													
<b>11. Solderability</b>													
Specified Value	At least 95% of terminal electrode is covered by new solder												
[Test Methods and Remarks]													
	<table border="1"> <thead> <tr> <th></th> <th>Solder type</th> <th>Solder temperature</th> <th>Duration</th> </tr> </thead> <tbody> <tr> <td>Eutectic solder</td> <td>H60A or H63A</td> <td>230±5°C</td> <td rowspan="2">4±1 sec.</td> </tr> <tr> <td>Lead-free solder</td> <td>Sn-3.0Ag-0.5Cu</td> <td>245±3°C</td> </tr> </tbody> </table>		Solder type	Solder temperature	Duration	Eutectic solder	H60A or H63A	230±5°C	4±1 sec.	Lead-free solder	Sn-3.0Ag-0.5Cu	245±3°C	
	Solder type	Solder temperature	Duration										
Eutectic solder	H60A or H63A	230±5°C	4±1 sec.										
Lead-free solder	Sn-3.0Ag-0.5Cu	245±3°C											

\* This catalog contains the typical specification only due to the limitation of space. When you consider purchase of our products, please check our specification. For details of each product (characteristics graph, reliability information, precautions for use, and so on), see our Web site (<http://www.ty-top.com/>) or CD catalogs.

## RELIABILITY DATA

12. Resistance to Soldering	
Specified Value	Appearance: No abnormality Capacitance change: Within±15% (HMK), ±10% (QMK, SMK) Dissipation factor: Initial value Insulation resistance: Initial value Withstanding voltage (between terminals): No abnormality
<b>[Test Methods and Remarks]</b> Preconditioning: Thermal treatment (at 150°C for 1hr) Note1 Solder temperature: 270±5°C Duration: 3±0.5sec. Preheating conditions: 80 to 100°C, 2 to 5 min. 150 to 200°C, 2 to 5 min. Recovery: 24±2hrs under the standard condition Note3	
13. Temperature Cycle (Thermal Shock)	
Specified Value	Appearance: No abnormality Capacitance change: Within±15% (HMK), ±7.5% (QMK, SMK) Dissipation factor: Initial value Insulation resistance: Initial value
<b>[Test Methods and Remarks]</b> Preconditioning: Thermal treatment (at 150°C for 1hr) Note1 Conditions for 1 cycle / Step 1: Minimum operating temperature $\pm 0^{\circ}\text{C}$ 30±3min. Step 2: Room temperature 2 to 3min. Step 3: Maximum operating temperature $\pm 0^{\circ}\text{C}$ 30±3min. Step 4: Room temperature 2 to 3min. Number of cycles: 5 times Recovery: 24±2hrs under the standard condition Note3	
14. Humidity (Steady state)	
Specified Value	Appearance: No abnormality Capacitance change: Within±15% Dissipation factor: 7%max (HMK), 5%max (QMK, SMK). Insulation resistance: 25MΩμF or 1000MΩ, whichever is smaller.
<b>[Test Methods and Remarks]</b> Preconditioning: Thermal treatment (at 150°C for 1hr) Note1 Temperature: 40±2°C Humidity: 90 to 95%RH Duration: 500 $\pm 24$ hrs Recovery: 24±2hrs under the standard condition Note3	
15. Humidity Loading	
Specified Value	Appearance: No abnormality Capacitance change: Within±15% Dissipation factor: 7%max (HMK), 5%max (QMK, SMK). Insulation resistance: 10MΩμF or 500MΩ, whichever is smaller.
<b>[Test Methods and Remarks]</b> According to JIS 5102 clause 9.9. Preconditioning: Voltage treatment Note2 Temperature: 40±2°C Humidity: 90 to 95%RH Applied voltage: Rated voltage Charge/discharge current: 50mA max. Duration: 500 $\pm 24$ hrs Recovery: 24±2hrs under the standard condition Note3	
16. High Temperature Loading	
Specified Value	Appearance: No abnormality Capacitance change: Within±15% Dissipation factor: 7%max (HMK), 5%max (QMK, SMK). Insulation resistance: 50MΩμF or 1000MΩ, whichever is smaller.
<b>[Test Methods and Remarks]</b> According to JIS 5102 clause 9.10. Preconditioning: Voltage treatment Note2 Temperature: 125±3°C (B7), 85±2°C (BJ) Applied voltage: Rated voltage×2 (HMK) Rated voltage×1.5 (QMK) Rated voltage×1.2 (SMK) Charge/discharge current: 50mA max. Duration: 1000 $\pm 24$ hrs Recovery: 24±2hrs under the standard condition Note3	
Note1 Thermal treatment: Initial value shall be measured after test sample is heat-treated at 150+0/-10°C for an hour and kept at room temperature for 24±2hours. Note2 Voltage treatment: Initial value shall be measured after test sample is voltage-treated for an hour at both the temperature and voltage specified in the test conditions, and kept at room temperature for 24±2hours. Note3 Standard condition: Temperature: 5 to 35°C, Relative humidity: 45 to 85 % RH, Air pressure: 86 to 106kPa When there are questions concerning measurement results, in order to provide correlation data, the test shall be conducted under the following condition. Temperature: 20±2°C, Relative humidity: 60 to 70 % RH, Air pressure: 86 to 106kPa Unless otherwise specified, all the tests are conducted under the "standard condition".	

\* This catalog contains the typical specification only due to the limitation of space. When you consider purchase of our products, please check our specification.  
 For details of each product (characteristics graph, reliability information, precautions for use, and so on), see our Web site (<http://www.ty-top.com/>) or CD catalogs.

# LW REVERSAL DECOUPLING CAPACITORS (LWDC™)



REFLOW

## FEATURES

- Low equivalent series resistance (ESR).
- Low equivalent series inductor (ESL).
- The effect of noise removal in the high frequency.
- Decreased ripple voltage.
- Small size with high capacitance.

## APPLICATIONS

- Decoupling capacitors
- Filtering capacitors

## ORDERING CODE

J W K 2 1 2 B J 1 0 6 M D - T △

<b>1</b> Rated voltage [VDC]	<b>2</b> Series name	<b>3</b> End termination	<b>4</b> Dimensions (EIA) L×W (mm)	<b>5</b> Temperature characteristics code	<b>6</b> Nominal capacitance (μF)	<b>7</b> Capacitance tolerance	<b>8</b> Thickness (mm)	<b>9</b> Special code	<b>10</b> Packaging	<b>11</b> Internal code
A 4 J 6.3 L 10 E 16 T 25	W LW Reverse Type	K Plated	105 (0204) 0.52×1.0 107 (0306) 0.8×1.6 212 (0508) 1.25×2.0	BJ B X5R B7 X7R C6 X6S C7 X7S	example 105 1.0 106 10.0	K ±10% M ±20%	P 0.3 V 0.5 A 0.8 D 0.85	- Standard Product	F φ178mm Taping (2mm pitch) 0204 Type T φ178mm Taping (4mm pitch) 0306, 0508 Type	△ Standard Product △=Blank space

## EXTERNAL DIMENSIONS/STANDARD QUANTITY

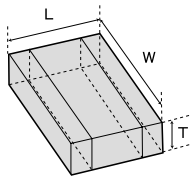

Type (EIA)	L	W	T	Standard quantity [pcs]	
				Paper tape	Embossed tape
□WK105 (0204)	0.52±0.05 (0.020±0.002)	1.00±0.05 (0.039±0.002)	0.30±0.05 (0.012±0.002) P	10000	-
			0.50±0.05 (0.020±0.002) V		
□WK107 (0306)	0.80±0.10 (0.031±0.004)	1.60±0.10 (0.063±0.004)	0.50±0.05 (0.020±0.002) V	-	4000
□WK212 (0508)	1.25±0.15 (0.049±0.006)	2.00±0.15 (0.079±0.006)	0.85±0.10 (0.033±0.004) D	4000	-

Unit : mm (inch)

## AVAILABLE CAPACITANCE RANGE

Cap [μF]	Type	105						107						212			
		Temp.Char	X7S	X6S	X5R	X7R	X7S	X6S	X5R	X6S	X5R	X6S	X5R				
		VDC	6.3	4	6.3	4	25	16	6.3	4	4	25	16	10	6.3	6.3	10
0.10	104	P		P		V					V						
0.22	224		P		P		V					V					
0.47	474		P	P		V						V					
1.0	105		V	V				V					V	V			
2.2	225								V					V			
4.7	475									V				V		D	D
10.0	106													V		D	D

\* Letters in the table indicate thickness.

Temp.char.Code	Temperature characteristics				Capacitance tolerance (%)
	Applicable standard	Temperature range [°C]	Ref. Temp. [°C]	Capacitance change [%]	
BJ	JIS	B	-25~+85	20	±10 (K) ±20 (M)
	EIA	X5R	-55~+85	25	
B7	EIA	X7R	-55~+125	25	
C6	EIA	X6S	-55~+105	25	
C7	EIA	X7S	-55~+125	25	

\* This catalog contains the typical specification only due to the limitation of space. When you consider purchase of our products, please check our specification. For details of each product (characteristics graph, reliability information, precautions for use, and so on), see our Web site (<http://www.ty-top.com/>) or CD catalogs.

## PART NUMBERS

### 105TYPE (0204 case size)

[Temp.char. BJ:X5R]

Rated Voltage	Ordering code	EHS (Environmental Hazardous Substances)	Capacitance [ $\mu$ F]	Temperature characteristics	Dissipation factor [%] Max.	Soldering method R:Reflow soldering W:Wave soldering	Capacitance tolerance	Thickness [mm] (inch)
6.3V	JWK105 BJ104MP* <sup>1</sup>	RoHS	0.1	X5R* <sup>2</sup>	5	R	$\pm 20\%$ [M]	0.3 $\pm$ 0.05 (0.012 $\pm$ 0.002)
	JWK105 BJ474MP* <sup>1</sup>	RoHS	0.47					0.5 $\pm$ 0.05 (0.020 $\pm$ 0.002)
	JWK105 BJ105MV* <sup>1</sup>	RoHS	1		10			0.3 $\pm$ 0.05 (0.012 $\pm$ 0.002)
4V	AWK105 BJ224MP* <sup>1</sup>	RoHS	0.22					0.3 $\pm$ 0.05 (0.012 $\pm$ 0.002)

\*1 1.5 times the rated voltage is applied to the chip during the high temperature loading test. \*2 We may provide X6S/X7S for some items according to the individual specification.

[Temp.char. C6:X6S C7:X7S]

Rated Voltage	Ordering code	EHS (Environmental Hazardous Substances)	Capacitance [ $\mu$ F]	Temperature characteristics	Dissipation factor [%] Max.	Soldering method R:Reflow soldering W:Wave soldering	Capacitance tolerance	Thickness [mm] (inch)
6.3V	JWK105 C7 104MP* <sup>1</sup>	RoHS	0.1	X7S	5	R	$\pm 20\%$ [M]	0.3 $\pm$ 0.05 (0.012 $\pm$ 0.002)
4V	AWK105 C6 224MP* <sup>1</sup>	RoHS	0.22	X6S	10			0.5 $\pm$ 0.05 (0.020 $\pm$ 0.002)
	AWK105 C6 474MP* <sup>1</sup>	RoHS	0.47					0.5 $\pm$ 0.05 (0.020 $\pm$ 0.002)
	AWK105 C6 105MV* <sup>1</sup>	RoHS	1					

\*1 1.5 times the rated voltage is applied to the chip during the high temperature loading test.

### 107TYPE (0306 case size)

[Temp.char. BJ:X5R]

Rated Voltage	Ordering code	EHS (Environmental Hazardous Substances)	Capacitance [ $\mu$ F]	Temperature characteristics	Dissipation factor [%] Max.	Soldering method R:Reflow soldering W:Wave soldering	Capacitance tolerance	Thickness [mm] (inch)
25V	TWK107 BJ 104MV	RoHS	0.1	X5R	5	R	$\pm 20\%$ [M]	0.5 $\pm$ 0.05 (0.020 $\pm$ 0.002)
16V	EWK107 BJ 224MV	RoHS	0.22					
	EWK107 BJ 474MV	RoHS	0.47					
10V	LWK107 BJ 105MV* <sup>1</sup>	RoHS	1	X5R	10	R	$\pm 20\%$ [M]	0.5 $\pm$ 0.05 (0.020 $\pm$ 0.002)
6.3V	JWK107 BJ 105MV* <sup>1</sup>	RoHS	1	X5R* <sup>2</sup>				
	JWK107 BJ 225MV* <sup>1</sup>	RoHS	2.2	X5R				

\*1 1.5 times the rated voltage is applied to the chip during the high temperature loading test. \*2 We may provide X7R/X7S for some items according to the individual specification.

[Temp.char. B7:X7R C7:X7S C6:X6S]

Rated Voltage	Ordering code	EHS (Environmental Hazardous Substances)	Capacitance [ $\mu$ F]	Temperature characteristics	Dissipation factor [%] Max.	Soldering method R:Reflow soldering W:Wave soldering	Capacitance tolerance	Thickness [mm] (inch)
25V	TWK107 B7 104MV* <sup>1</sup>	RoHS	0.1	X7R	5	R	$\pm 20\%$ [M]	0.5 $\pm$ 0.05 (0.020 $\pm$ 0.002)
16V	EWK107 B7 224MV* <sup>1</sup>	RoHS	0.22					
	EWK107 B7 474MV* <sup>1</sup>	RoHS	0.47					
6.3V	JWK107 C7 105MV* <sup>1</sup>	RoHS	1	X7S	10	R	$\pm 20\%$ [M]	0.5 $\pm$ 0.05 (0.020 $\pm$ 0.002)
4V	AWK107 C7 225MV* <sup>1</sup>	RoHS	2.2	X6S				
	AWK107 C6 475MV* <sup>1</sup>	RoHS	4.7					

\*1 1.5 times the rated voltage is applied to the chip during the high temperature loading test.

### 212TYPE (0508 case size)

[Temp.char. BJ:X5R]

Rated Voltage	Ordering code	EHS (Environmental Hazardous Substances)	Capacitance [ $\mu$ F]	Temperature characteristics	Dissipation factor [%] Max.	Soldering method R:Reflow soldering W:Wave soldering	Capacitance tolerance	Thickness [mm] (inch)
10V	LWK212 BJ475□D* <sup>1</sup>	RoHS	4.7	X5R	10	R	$\pm 10\%$ [K]	0.85 $\pm$ 0.1 (0.033 $\pm$ 0.004)
	LWK212 BJ106MD* <sup>1</sup>	RoHS	10				$\pm 20\%$ [M]	

□ Please specify the capacitance tolerance code. \*1 1.5 times the rated voltage is applied to the chip during the high temperature loading test.

[Temp.char. C6:X6S]

Rated Voltage	Ordering code	EHS (Environmental Hazardous Substances)	Capacitance [ $\mu$ F]	Temperature characteristics	Dissipation factor [%] Max.	Soldering method R:Reflow soldering W:Wave soldering	Capacitance tolerance	Thickness [mm] (inch)
6.3V	JWK212 C6 475□D* <sup>1</sup>	RoHS	4.7	X6S	10	R	$\pm 10\%$ [K]	0.85 $\pm$ 0.1 (0.033 $\pm$ 0.004)
	JWK212 C6 106MD* <sup>1</sup>	RoHS	10				$\pm 20\%$ [M]	

□ Please specify the capacitance tolerance code. \*1 1.5 times the rated voltage is applied to the chip during the high temperature loading test.

## ELECTRICAL CHARACTERISTICS

### Example of Impedance ESR vs. Frequency characteristics

#### Taiyo Yuden multilayer ceramic capacitor

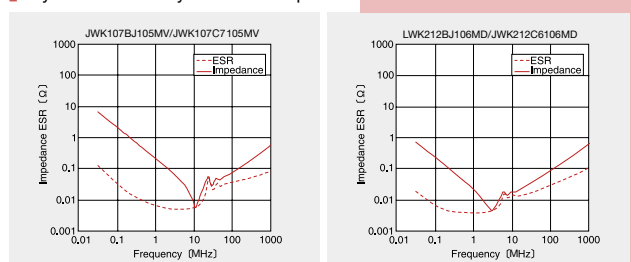

\* This catalog contains the typical specification only due to the limitation of space. When you consider purchase of our products, please check our specification. For details of each product (characteristics graph, reliability information, precautions for use, and so on), see our Web site (<http://www.ty-top.com/>) or CD catalogs.

# ARRAY TYPE MULTILAYER CERAMIC CAPACITORS



REFLOW

## FEATURES

- High density and high efficiency mounting.
- Internal electrodes are composed of nickel for improved cost performance and reliability.

## APPLICATIONS

- General electronic equipment
- Communication equipment (cellular phone, wireless applications, etc.)

## ORDERING CODE

E 4 K 2 1 2 B J 1 0 4 M D - T  $\triangle$

**1 Rated voltage (VDC)**

J	6.3
L	10
E	16
T	25
U	50

**2 Series name**

2	2 circuits multilayer capacitor
4	4 circuits multilayer capacitor

**3 End termination**

K	Plated
---	--------

**4 Dimensions (EIA) L×W (mm)**

096 (0302)	0.9×0.6
110 (0504)	1.4×1.0
212 (0805)	2.0×1.25

**5 Temperature characteristics code**

BJ	B
	X5R
B7	X7R
	CH
CH	C0H

**6 Nominal capacitance (pF)**

example	
104	100,000
105	1,000,000

**7 Capacitance tolerance**

F	±1pF
K	±10%
M	±20%

**8 Thickness (mm)**

P	0.3
K	0.45
V	0.5
B	0.6
A	0.8
D	0.85

**9 Special code**

-	Standard Product
---	------------------

**10 Packaging**

T	φ178mm Taping (4mm pitch) 0504, 0805 Type
F	φ178mm Taping (2mm pitch) 0302 Type

**11 Internal code**

$\triangle$	Standard Product
-------------	------------------

$\triangle$ =Blank space

## EXTERNAL DIMENSIONS/STANDARD QUANTITY

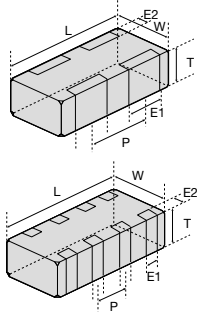

Type (EIA)	L	W	E1	E2	P	T	Standard quantity [pcs]		
							Paper tape	Embossed tape	
□2K096 (0302)	0.9±0.05 (0.035±0.002)	0.6±0.05 (0.024±0.002)	0.23±0.10 (0.009±0.004)	0.125±0.075 (0.005±0.003)	0.45±0.05 (0.018±0.002)	P	0.30±0.03 (0.012±0.001)	10000	-
						K	0.45±0.05 (0.018±0.002)		
□2K110 (0504)	1.37±0.07 (0.054±0.003)	1.00±0.08 (0.039±0.003)	0.36±0.10 (0.014±0.004)	0.2±0.10 (0.008±0.004)	0.64±0.10 (0.025±0.004)	V	0.5±0.05 (0.020±0.002)	4000	-
						B	0.60±0.06 (0.024±0.003)		
						A	0.80±0.08 (0.031±0.003)		
□2K212 (0805)	2.00±0.10 (0.079±0.004)	1.25±0.10 (0.049±0.004)	0.50±0.20 (0.020±0.008)	0.25±0.15 (0.010±0.006)	1.00±0.10 (0.039±0.004)	D	0.85±0.10 (0.033±0.004)	4000	-
□4K212 (0805)	2.00±0.10 (0.079±0.004)	1.25±0.10 (0.049±0.004)	0.25±0.10 (0.010±0.004)	0.25±0.15 (0.010±0.006)	0.50±0.10 (0.020±0.004)	D	0.85±0.10 (0.033±0.004)	4000	-

Unit : mm (inch)

## AVAILABLE CAPACITANCE RANGE

BJ/B7

Cap [μF]	Type	096 2 circuits □2K096		110 2 circuits □2K110						212 2 circuits □2K212			212 4 circuits □4K212									
		Temp. Char		B/X5R			X7R			B/X5R			X5R			B/X5R						
		VDC		10V	6.3V	50V	25V	16V	50V	25V	16V	10V	16V	10V	6.3V	25V	10V	16V	25V	16V	10V	10V
		[pF:3digits]																				
0.001	102					B				B												
0.0022	222					B				B												
0.0047	472					B				B												
0.01	103	P				B				B												
0.022	223					B				B												
0.047	473		K			B				B												
0.1	104		K			B				B												
0.22	224		K							B												D
0.47	474									A												D
1.0	105										A	AV	V	D								D
2.2	225													A		D						

\* Letters in the table indicate thickness.

CH

Cap [pF]	Type	096 2 circuits □2K096		110 2 circuits □2K110	
		Temp. Char		CH	
		VDC		25V	
		[pF:3digits]			
10	100	P		B	
12	120	P		B	
15	150	P		B	
18	180	P		B	
22	220	P		B	
27	270	P		B	
33	330	P		B	
39	390	P		B	
47	470	P		B	
56	560	P		B	
68	680	P		B	
82	820	P		B	
100	101	P		B	

\* Letters in the table indicate thickness.

Temp. char. Code	Temperature characteristics				Capacitance tolerance (%)
	Applicable standard	Temperature range (°C)	Ref. Temp. (°C)	Capacitance change	
BJ	JIS	B	-25~+85	20	±10 (K) ±20 (M)
	EIA	X5R	-55~+85	25	
B7	EIA	X7R	-55~+125	25	±15 [%]
	JIS	CH	-55~+125	20	
CH	EIA	C0H	-55~+125	25	±60 [ppm/°C]
					±60 [ppm/°C]

\* This catalog contains the typical specification only due to the limitation of space. When you consider purchase of our products, please check our specification. For details of each product (characteristics graph, reliability information, precautions for use, and so on), see our Web site (<http://www.ty-top.com/>) or CD catalogs.



**PART NUMBERS**

● 096TYPE (0302 case size) 2 circuits type

[Temp.char. BJ:B/X5R]

Rated Voltage	Ordering code	EHS (Environmental Hazardous Substances)	Capacitance [ $\mu$ F]	Temperature characteristics	Dissipation factor [%]Max.	Soldering method R:Reflow soldering W:Wave soldering	Capacitance tolerance	Thickness [mm] (inch)
10V	L2K096 BJ103□P	RoHS	0.01	B/X5R	5	R	$\pm 10\%$ [K] $\pm 20\%$ [M]	0.3 $\pm$ 0.03 (0.012 $\pm$ 0.001)
6.3V	J2K096 BJ473□K <sup>*1</sup>	RoHS	0.047	X5R				10
	J2K096 BJ104□K <sup>*1</sup>	RoHS	0.1					
	J2K096 BJ224MK <sup>*1</sup>	RoHS	0.22					

□ Please specify the capacitance tolerance code.

\*1 1.5 times the rated voltage is applied to the chip during the high temperature loading test.

[Temp.char. CH:CH/C0H]

Rated Voltage	Ordering code	EHS (Environmental Hazardous Substances)	Capacitance [pF]	Temperature characteristics	Q	Soldering method R:Reflow soldering W:Wave soldering	Capacitance tolerance	Thickness [mm] (inch)
25V	T2K096 CH100FP	RoHS	10	CH/C0H	400+20·C	R	$\pm 1$ pF [F]	0.3 $\pm$ 0.03 (0.012 $\pm$ 0.001)
	T2K096 CH120KP	RoHS	12					
	T2K096 CH150KP	RoHS	15					
	T2K096 CH180KP	RoHS	18					
	T2K096 CH220KP	RoHS	22					
	T2K096 CH270KP	RoHS	27					
	T2K096 CH330KP	RoHS	33		1000		$\pm 10\%$ [K]	
	T2K096 CH390KP	RoHS	39					
	T2K096 CH470KP	RoHS	47					
	T2K096 CH560KP	RoHS	56					
	T2K096 CH680KP	RoHS	68					
	T2K096 CH820KP	RoHS	82					
	T2K096 CH101KP	RoHS	100					

Note: Please contact Taiyo Yuden sales channels about temperature characteristics other than listed above.

● 110TYPE (0504 case size) 2 circuits type

[Temp.char. BJ:B/X5R]

Rated Voltage	Ordering code	EHS (Environmental Hazardous Substances)	Capacitance [ $\mu$ F]	Temperature characteristics	Dissipation factor [%]Max.	Soldering method R:Reflow soldering W:Wave soldering	Capacitance tolerance	Thickness [mm] (inch)	
50V	U2K110 BJ102□B	RoHS	0.001	B/X5R <sup>*2</sup>	3.5	R	$\pm 10\%$ [K] $\pm 20\%$ [M]	0.6 $\pm$ 0.06 (0.024 $\pm$ 0.002)	
	U2K110 BJ222□B	RoHS	0.0022						
	U2K110 BJ472□B	RoHS	0.0047						
25V	T2K110 BJ103□B	RoHS	0.01	B/X5R <sup>*2</sup>	5				
	T2K110 BJ223□B	RoHS	0.022						
	T2K110 BJ104□B	RoHS	0.1						
16V	E2K110 BJ473□B	RoHS	0.047	X5R	3.5				
	E2K110 BJ104□B	RoHS	0.1		5				
	E2K110 BJ105□A <sup>*1</sup>	RoHS	1.0		10				
10V	L2K110 BJ224□B	RoHS	0.22	B/X5R	5		R	$\pm 20\%$ [M]	0.8 $\pm$ 0.08 (0.031 $\pm$ 0.003)
	L2K110 BJ474□A	RoHS	0.47						
	L2K110 BJ105□A <sup>*1</sup>	RoHS	1.0						
	L2K110 BJ105MV <sup>*1</sup>	RoHS	1.0						
6.3V	J2K110 BJ105□V <sup>*1</sup>	RoHS	1.0	X5R	10	R	$\pm 10\%$ [K] $\pm 20\%$ [M]	0.5 $\pm$ 0.05 (0.02 $\pm$ 0.002)	
	J2K110 BJ225□A <sup>*1</sup>	RoHS	2.2					0.8 $\pm$ 0.08 (0.031 $\pm$ 0.003)	

□ Please specify the capacitance tolerance code.

\*1 1.5 times the rated voltage is applied to the chip during the high temperature loading test.

\*2 We may provide X7R for some items according to the individual specification.

[Temp.char. B7:X7R]

Rated Voltage	Ordering code	EHS (Environmental Hazardous Substances)	Capacitance [ $\mu$ F]	Temperature characteristics	Dissipation factor [%]Max.	Soldering method R:Reflow soldering W:Wave soldering	Capacitance tolerance	Thickness [mm] (inch)
50V	U2K110 B7 102□B	RoHS	0.001	X7R	3.5	R	$\pm 10\%$ [K] $\pm 20\%$ [M]	0.6 $\pm$ 0.06 (0.024 $\pm$ 0.002)
	U2K110 B7 222□B	RoHS	0.0022					
	U2K110 B7 472□B	RoHS	0.0047					
25V	T2K110 B7 103□B	RoHS	0.01					
	T2K110 B7 223□B	RoHS	0.022					
	E2K110 B7 473□B	RoHS	0.047					
16V	E2K110 B7 104□B	RoHS	0.1	X7R	5	R	$\pm 20\%$ [M]	0.5 $\pm$ 0.05 (0.02 $\pm$ 0.002)
	E2K110 B7 104□B	RoHS	0.1					0.8 $\pm$ 0.08 (0.031 $\pm$ 0.003)

□ Please specify the capacitance tolerance code.

\* This catalog contains the typical specification only due to the limitation of space. When you consider purchase of our products, please check our specification. For details of each product (characteristics graph, reliability information, precautions for use, and so on), see our Web site (<http://www.ty-top.com/>) or CD catalogs.

## PART NUMBERS

[Temp.char. CH:CH/C0H]

Rated Voltage	Ordering code		EHS (Environmental Hazardous Substances)	Capacitance [pF]	Temperature characteristics	Q	Soldering method R:Reflow soldering W:Wave soldering	Capacitance tolerance	Thickness [mm] (inch)
50V	U2K110 CH100FB		RoHS	10	CH/C0H	400+20·C	R	±1pF(F)	0.6±0.06 (0.024±0.002)
	U2K110 CH120KB		RoHS	12					
	U2K110 CH150KB		RoHS	15					
	U2K110 CH180KB		RoHS	18					
	U2K110 CH220KB		RoHS	22					
	U2K110 CH270KB		RoHS	27					
	U2K110 CH330KB		RoHS	33		1000		±10% [K]	
	U2K110 CH390KB		RoHS	39					
	U2K110 CH470KB		RoHS	47					
	U2K110 CH560KB		RoHS	56					
	U2K110 CH680KB		RoHS	68					
U2K110 CH820KB		RoHS	82						
U2K110 CH101KB		RoHS	100						

Note: Please contact Taiyo Yuden sales channels about temperature characteristics other than listed above.

### ●212TYPE (0805 case size) 2 circuits type

[Temp.char. BJ:B/X5R]

Rated Voltage	Ordering code		EHS (Environmental Hazardous Substances)	Capacitance [μF]	Temperature characteristics	Dissipation factor [%] Max.	Soldering method R:Reflow soldering W:Wave soldering	Capacitance tolerance	Thickness [mm] (inch)
25V	T2K212 BJ105□D		RoHS	1.0	B/X5R	5	R	±10% [K] ±20% [M]	0.85±0.1 (0.033±0.004)
10V	L2K212 BJ225MD <sup>*1</sup>		RoHS	2.2	X5R	10		±20% [M]	

□ Please specify the capacitance tolerance code.

\*1 1.5 times the rated voltage is applied to the chip during the high temperature loading test.

### ●212TYPE (0805 case size) 4 circuits type

[Temp.char. BJ:B/X5R]

Rated Voltage	Ordering code		EHS (Environmental Hazardous Substances)	Capacitance [μF]	Temperature characteristics	Dissipation factor [%] Max.	Soldering method R:Reflow soldering W:Wave soldering	Capacitance tolerance	Thickness [mm] (inch)
25V	T4K212 BJ104□D		RoHS	0.1	B/X5R	5	R	±10% [K] ±20% [M]	0.85±0.1 (0.033±0.004)
16V	E4K212 BJ104□D		RoHS	0.1	B/X5R <sup>*2</sup>				
10V	L4K212 BJ224□D		RoHS	0.22	B/X5R				
	L4K212 BJ474□D		RoHS	0.47					
	L4K212 BJ105□D <sup>*1</sup>		RoHS	1	X5R	10			

□ Please specify the capacitance tolerance code.

\*1 1.5 times the rated voltage is applied to the chip during the high temperature loading test.

\*2 We may provide X7R for some items according to the individual specification.

[Temp.char. B7:X7R]

Rated Voltage	Ordering code		EHS (Environmental Hazardous Substances)	Capacitance [μF]	Temperature characteristics	Dissipation factor [%] Max.	Soldering method R:Reflow soldering W:Wave soldering	Capacitance tolerance	Thickness [mm] (inch)
16V	E4K212 B7 104□D		RoHS	0.1	X7R	5	R	±10% [K] ±20% [M]	0.85±0.1 (0.033±0.004)

□ Please specify the capacitance tolerance code.

\* This catalog contains the typical specification only due to the limitation of space. When you consider purchase of our products, please check our specification.  
For details of each product (characteristics graph, reliability information, precautions for use, and so on), see our Web site (<http://www.ty-top.com/>) or CD catalogs.

## ELECTRICAL CHARACTERISTICS

### Example of Impedance ESR vs. Frequency characteristics

#### Taiyo Yuden multilayer ceramic capacitor

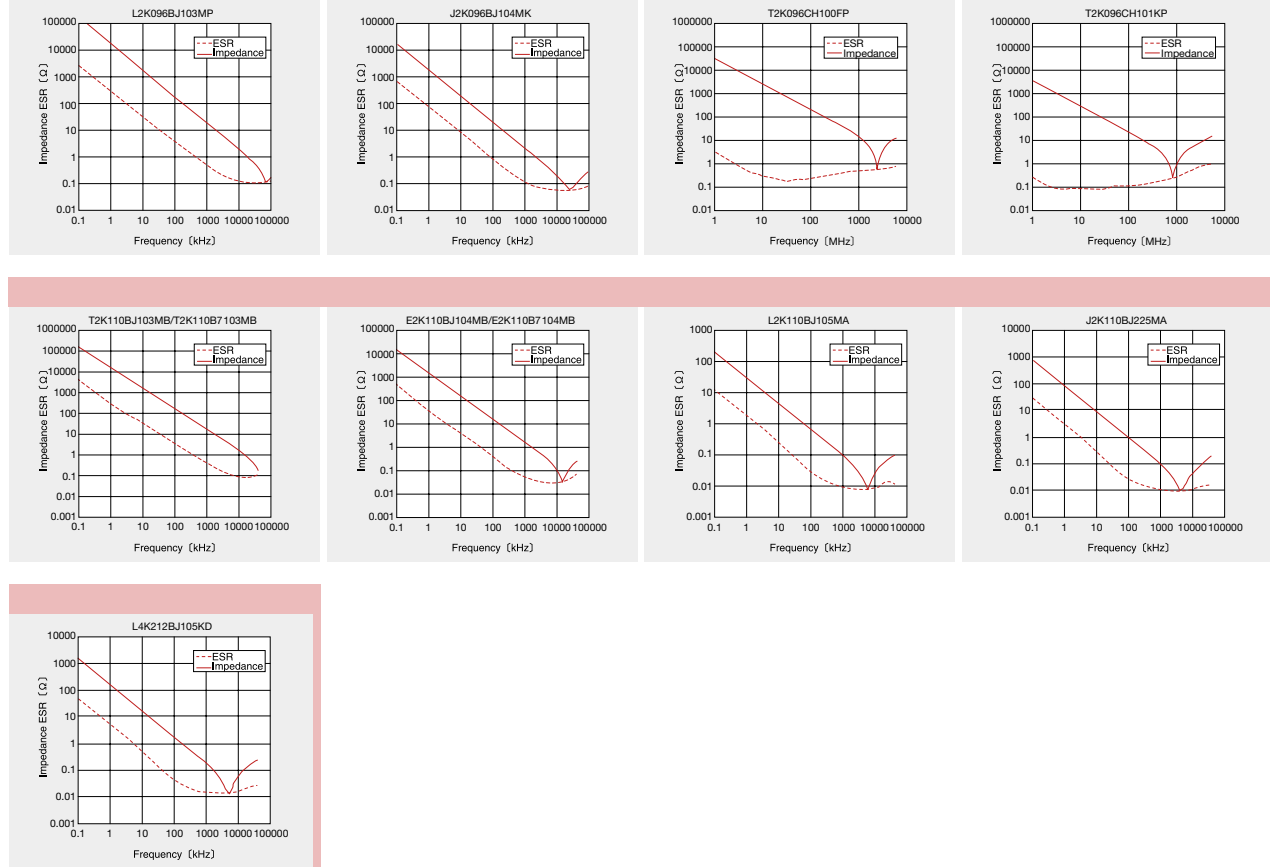

\* This catalog contains the typical specification only due to the limitation of space. When you consider purchase of our products, please check our specification. For details of each product (characteristics graph, reliability information, precautions for use, and so on), see our Web site (<http://www.ty-top.com/>) or CD catalogs.

# PACKAGING

## ① Minimum Quantity

### ● Taped packaging

Type (EIA)	Thickness		Standard quantity [pcs]		
	mm (inch)	code	Paper tape	Embossed tape	
□MK042(01005)	0.2(0.008)	C	20000	—	
□MK063(0201)	0.3(0.012)	P,T	15000		
□2K096(0302)	0.3(0.012)	P	10000		
	0.45(0.018)	K			
□WK105(0204)	0.3(0.012)	P			
	0.5(0.020)	V			
□MK105(0402)	0.5(0.020)	V, W			
□VK105(0402)	0.5(0.020)	W			
	0.45(0.018)	K			4000
□MK107(0603)	0.5(0.020)	V			—
□WK107(0306)	0.8(0.031)	A		4000	
	0.5(0.020)	V			
□2K110(0504)	0.6(0.024)	B			
	0.8(0.031)	A			
□MK212(0805)	0.45(0.018)	K			
□WK212(0508)	0.85(0.033)	D			
	1.25(0.049)	G	—		3000
□4K212(0805)	0.85(0.033)	D	4000		
□2K212(0805)	0.85(0.033)	D			
	0.85(0.033)	D			
□MK316(1206)	1.15(0.045)	F			
	1.25(0.049)	G			
	1.6(0.063)	L		—	3000
□MK325(1210)	0.85(0.033)	D			
	1.15(0.045)	F			
	1.9(0.075)	N			
	2.0max(0.079)	Y			
	2.5(0.098)	M	500(T), 1000(P)		
□MK432(1812)	2.5(0.098)	M	—		500

## ② Taping material

※No bottom tape for pressed carrier tape

### ● Paper tape

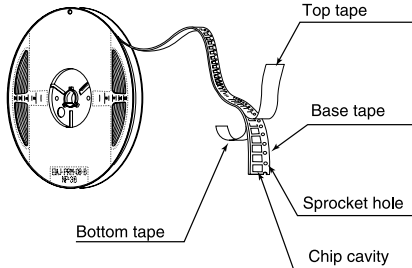

### ● Embossed tape

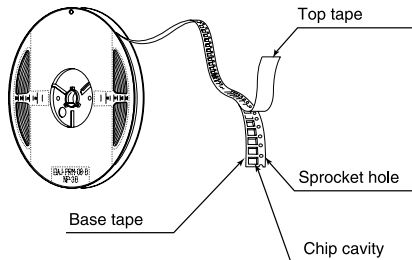

### ● Chip filled

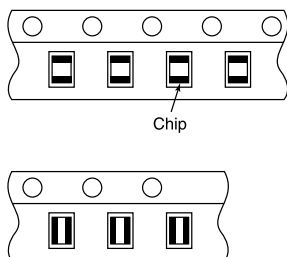

## ③ Taping dimensions

### ● Paper Tape (0.315 inches wide)

### ● Pressed carrier tape (2mm pitch)

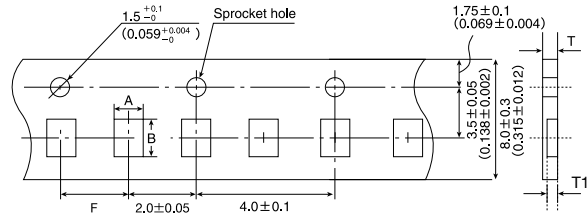

Type (EIA)	Chip Cavity		Insertion Pitch F	Tape Thickness	
	A	B		T	T1
□MK042(01005)	0.25 (0.010)	0.45 (0.018)	2.0±0.05 (0.079±0.002)	0.36max. (0.014)	0.27max. (0.011)
□MK063(0201)	0.37 (0.016)	0.67 (0.027)		0.45max. (0.018)	0.42max. (0.017)
□WK105(0204)	0.65 (0.026)	1.15 (0.045)		0.45max. (0.018max.)	0.42max. (0.017max.)

Unit : mm (inch)

### ● Punched carrier tape (2mm pitch)

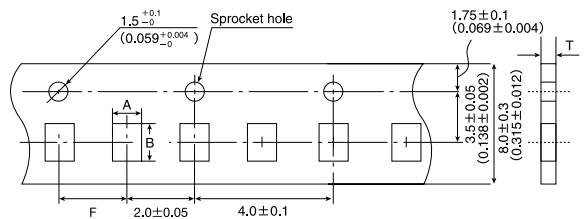

Type (EIA)	Chip Cavity		Insertion Pitch F	Tape Thickness
	A	B		T
□2K096(0302)	0.72 (0.028)	1.02 (0.040)	2.0±0.05 (0.079±0.002)	0.45max.(0.018max.) 0.6max.(0.024max.)
□MK105(0402)	0.65 (0.026)	1.15 (0.045)		0.8max. (0.031max.)
□VK105(0402)				

Unit : mm (inch)

### ● Punched carrier tape (4mm pitch)

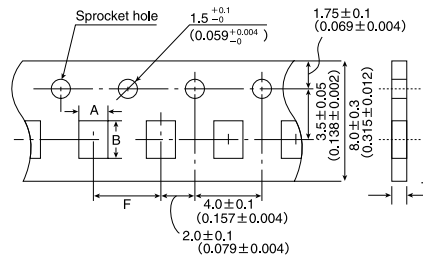

Type (EIA)	Chip Cavity		Insertion Pitch F	Tape Thickness
	A	B		T
□MK107(0603)	1.0 (0.039)	1.8 (0.071)	4.0±0.1 (0.157±0.004)	1.1max. (0.043max.)
□WK107(0306)				1.0max. (0.039max.)
□2K110(0504)	1.15 (0.045)	1.55 (0.061)	4.0±0.1 (0.157±0.004)	1.1max. (0.043max.)
□MK212(0805)	1.65 (0.065)	2.4 (0.094)		
□4K212(0805)				
□2K212(0805)				
□MK316(1206)	2.0 (0.079)	3.6 (0.142)		

Unit : mm (inch)

\* This catalog contains the typical specification only due to the limitation of space. When you consider purchase of our products, please check our specification. For details of each product (characteristics graph, reliability information, precautions for use, and so on), see our Web site (<http://www.ty-top.com/>) or CD catalogs.

## PACKAGING

### ● Embossed tape (0.315 inches wide)

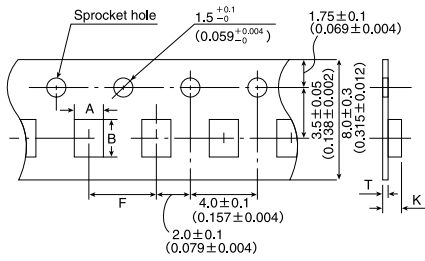

Type(EIA)	Chip Cavity		Insertion Pitch F	Tape Thickness	
	A	B		K	T
□WK107(0306)	1.0 (0.039)	1.8 (0.071)	4.0 $\pm$ 0.1 (0.157 $\pm$ 0.004)	1.3max. (0.051max.)	0.25 $\pm$ 0.1 (0.01 $\pm$ 0.004)
□MK212(0805)	1.65 (0.065)	2.4 (0.094)		3.4max. (0.134max.)	0.6max. (0.024max.)
□MK316(1206)	2.0 (0.079)	3.6 (0.142)			
□MK325(1210)	2.8 (0.110)	3.6 (0.142)			

Unit : mm (inch)

### ● Embossed tape (0.472 inches wide)

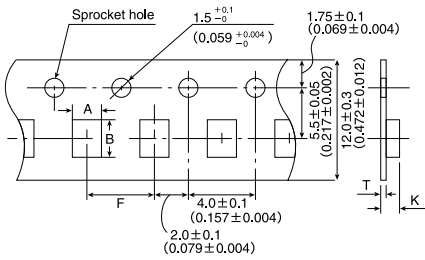

Type(EIA)	Chip Cavity		Insertion Pitch F	Tape Thickness	
	A	B		K	T
□MK432(1812)	3.7 (0.146)	4.9 (0.193)	8.0 $\pm$ 0.1 (0.315 $\pm$ 0.004)	4.0max. (0.157max.)	0.6max. (0.024max.)

Unit : mm (inch)

### ④ Leader and Blank portion

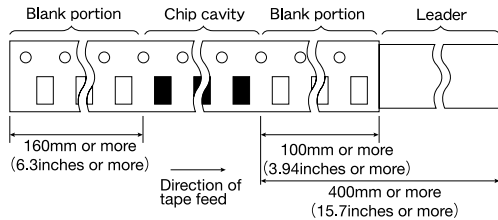

### ⑤ Reel size

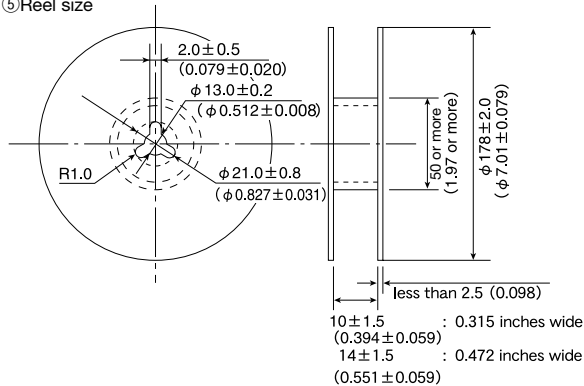

### ⑥ Top Tape Strength

Unit : mm (inch)

The top tape requires a peel-off force of 0.1 to 0.7N in the direction of the arrow as illustrated below.

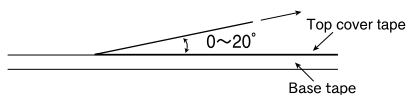

### ⑦ Bulk Cassette

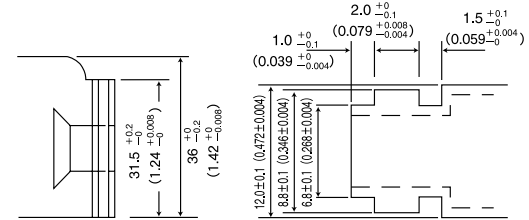
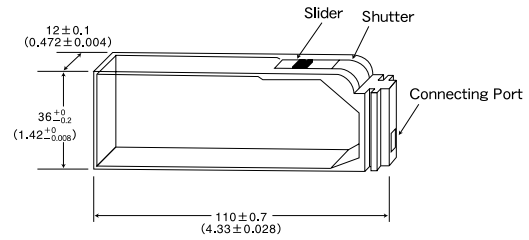

Unit : mm (inch)

\* This catalog contains the typical specification only due to the limitation of space. When you consider purchase of our products, please check our specification. For details of each product (characteristics graph, reliability information, precautions for use, and so on), see our Web site (<http://www.ty-top.com/>) or CD catalogs.

Super Low Distortion Multilayer Ceramic Capacitors and Medium-High Voltage Multilayer Ceramic Capacitors are noted separately.

Multilayer Ceramic Capacitors

1. Operating Temperature Range

Specified Value	Temperature Compensating (Class 1)	Standard	-55 to +125°C		
		High Frequency Type			
High Permittivity (Class 2)			Specification	Temperature Range	
			BJ	B	-25 to +85°C
				X5R	-55 to +85°C
			B7	X7R	-55 to +125°C
			C6	X6S	-55 to +105°C
			C7	X7S	-55 to +125°C
			F	F	-25 to +85°C
	Y5V	-30 to +85°C			

2. Storage Temperature Range

Specified Value	Temperature Compensating (Class 1)	Standard	-55 to +125°C		
		High Frequency Type			
High Permittivity (Class 2)			Specification	Temperature Range	
			BJ	B	-25 to +85°C
				X5R	-55 to +85°C
			B7	X7R	-55 to +125°C
			C6	X6S	-55 to +105°C
			C7	X7S	-55 to +125°C
			F	F	-25 to +85°C
	Y5V	-30 to +85°C			

3. Rated Voltage

Specified Value	Temperature Compensating (Class 1)	Standard	50VDC, 25VDC, 16VDC
		High Frequency Type	50VDC, 16VDC
	High Permittivity (Class 2)		50VDC, 35VDC, 25VDC, 16VDC, 10VDC, 6.3VDC, 4VDC

4. Withstanding Voltage (Between terminals)

Specified Value	Temperature Compensating (Class 1)	Standard	No breakdown or damage
		High Frequency Type	
	High Permittivity (Class 2)		

[Test Methods and Remarks]

	Class 1	Class 2
Applied voltage	Rated voltage×3	Rated voltage×2.5
Duration	1 to 5 sec.	
Charge/discharge current	50mA max.	

5. Insulation Resistance

Specified Value	Temperature Compensating (Class 1)	Standard	10000 MΩ min.
		High Frequency Type	
	High Permittivity (Class 2) Note 1		C≤0.047μF : 10000 MΩ min. C>0.047μF : 500MΩ·μF

[Test Methods and Remarks]

Applied voltage: Rated voltage  
Duration: 60±5 sec.  
Charge/discharge current: 50mA max.

6. Capacitance (Tolerance)

Specified Value	Temperature Compensating (Class 1)	Standard	<table border="1"> <tr> <td>C△</td> <td>0.5pF≤C≤5pF : ±0.25pF</td> <td rowspan="3">RH</td> <td rowspan="3">0.5pF≤C≤2pF : ±0.1pF</td> </tr> <tr> <td>U△</td> <td>0.5pF&lt;C≤10pF : ±0.5pF</td> </tr> <tr> <td></td> <td>C&gt;10pF : ±5%</td> </tr> </table>	C△	0.5pF≤C≤5pF : ±0.25pF	RH	0.5pF≤C≤2pF : ±0.1pF	U△	0.5pF<C≤10pF : ±0.5pF		C>10pF : ±5%	S△	C>2pF : ±5%
		C△	0.5pF≤C≤5pF : ±0.25pF	RH	0.5pF≤C≤2pF : ±0.1pF								
U△	0.5pF<C≤10pF : ±0.5pF												
	C>10pF : ±5%												
		T△											
	High Frequency Type	<table border="1"> <tr> <td>CH</td> <td>0.5pF≤C≤2pF : ±0.1pF</td> </tr> <tr> <td>RH</td> <td>C&gt;2pF : ±5%</td> </tr> </table>	CH	0.5pF≤C≤2pF : ±0.1pF	RH	C>2pF : ±5%							
CH	0.5pF≤C≤2pF : ±0.1pF												
RH	C>2pF : ±5%												
	High Permittivity (Class 2)		BJ, B7, C6,C7 : ±10% or ±20%, F : -20%/+80%										

[Test Methods and Remarks]

	Class 1		Class 2	
	Standard	High Frequency Type	C≤10μF	C>10μF
Preconditioning	None		Thermal treatment (at 150°C for 1hr) Note 2	
Measuring frequency	1MHz±10%		1kHz±10%	120±10Hz
Measuring voltage Note 1	0.5 to 5Vrms		1±0.2Vrms	0.5±0.1Vrms
Bias application	None			

7. Q or Dissipation Factor

Specified Value	Temperature Compensating (Class 1)	Standard	C<30 pF : Q≥400+20C, C≥30 pF : Q≥1000 (C : Nominal capacitance)
		High Frequency Type	Refer to detailed specification
	High Permittivity (Class 2) Note 1		BJ, B7, C6,C7 : 2.5% max., F : 7% max.

[Test Methods and Remarks]

	Class 1		Class 2	
	Standard	High Frequency Type	C≤10μF	C>10μF
Preconditioning	None		Thermal treatment (at 150°C for 1hr) Note 2	
Measuring frequency	1MHz±10%	1GHz	1kHz±10%	120±10Hz
Measuring voltage Note 1	0.5 to 5Vrms		1±0.2Vrms	0.5±0.1Vrms
Bias application	None			

High Frequency Type  
Measuring equipment: HP4291A  
Measuring jig: HP16192A

\* This catalog contains the typical specification only due to the limitation of space. When you consider purchase of our products, please check our specification.  
For details of each product (characteristics graph, reliability information, precautions for use, and so on), see our Web site (<http://www.ty-top.com/>) or CD catalogs.

## RELIABILITY DATA

### 8. Temperature Characteristic of Capacitance (Without voltage application)

Specified Value	Temperature Compensating (Class 1)	Standard	Temperature Characteristic [ppm/°C]		Tolerance
			C□ : 0	CH, CJ, CK	
High Permittivity (Class 2)	High Permittivity (Class 2)	High Frequency Type	R□ : -220	RH	H±60 J±120 K±250
			S□ : -330	SH, SJ, SK	
			T□ : -470	TJ, TK	
			U□ : -750	UJ, UK	
			SL : +350 to -1000		

Specified Value	Specification	Capacitance change	Reference temperature	Temperature Range
BJ	B	±10%	20°C	-25 to +85°C
	X5R	±15%	25°C	-55 to +85°C
B7	X7R	±15%	25°C	-55 to +125°C
C6	X6S	±22%	25°C	-55 to +105°C
C7	X7S	±22%	25°C	-55 to +125°C
F	F	+30/-80%	20°C	-25 to +85°C
	Y5V	+22/-82%	25°C	-30 to +85°C

#### [Test Methods and Remarks]

##### Class 1

Capacitance at 20°C and 85°C shall be measured in thermal equilibrium, and the temperature characteristic shall be calculated from the following equation.

$$\frac{(C_{85} - C_{20})}{C_{20} \times \Delta T} \times 10^6 \text{ (ppm/°C)} \quad \Delta T = 65$$

##### Class 2

Capacitance at each step shall be measured in thermal equilibrium, and the temperature characteristic shall be calculated from the following equation.

Step	B, F	5R, X7R, X6S, X7S, Y5V	$\frac{(C - C_2)}{C_2} \times 100 (\%)$
1	Minimum operating temperature		C : Capacitance in Step 1 or Step 3 C <sub>2</sub> : Capacitance in Step 2
2	20°C	25°C	
3	Maximum operating temperature		

### 9. Deflection

Specified Value	Temperature Compensating (Class 1)	Standard	Appearance : No abnormality Capacitance change : Within ±5% or ±0.5 pF, whichever is larger.
	High Permittivity (Class 2)	High Frequency Type	Appearance : No abnormality Capacitance change : Within ±0.5 pF
		High Permittivity (Class 2)	Appearance : No abnormality Capacitance change : Within ±12.5% (BJ, B7, C6, C7), Within ±30% (F)

#### [Test Methods and Remarks]

##### Multilayer Ceramic Capacitors

	Board	Thickness	Warp	Duration
042, 063 Type	glass epoxy-resin substrate	0.8mm	1mm	10 sec.
105 Type or more		1.6mm		

##### Array Type

	Board	Thickness	Warp	Duration
096, 110, 212 Type	glass epoxy-resin substrate	1.6mm	1mm	10 sec.

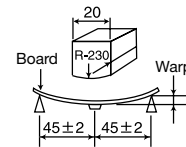

Capacitance measurement shall be conducted with the board bent

### 10. Body Strength

Specified Value	Temperature Compensating (Class 1)	Standard	—
	High Permittivity (Class 2)	High Frequency Type	No mechanical damage.
		High Permittivity (Class 2)	—

#### [Test Methods and Remarks]

##### High Frequency Type

Applied force: 5N

Duration: 10 sec.

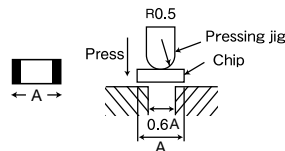

### 11. Adhesive Strength of Terminal Electrodes

Specified Value	Temperature Compensating (Class 1)	Standard	No terminal separation or its indication.
	High Permittivity (Class 2)	High Frequency Type	
		High Permittivity (Class 2)	

#### [Test Methods and Remarks]

##### Multilayer Ceramic Capacitors

	Applied force	Duration
042, 063 Type	2N	30±5 sec.
105 Type or more	5N	

##### Array Type

	Applied force	Duration
096 Type	2N	30±5 sec.
110, 212 Type	5N	

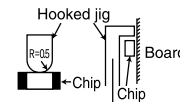

### 12. Solderability

Specified Value	Temperature Compensating (Class 1)	Standard	At least 95% of terminal electrode is covered by new solder.
	High Permittivity (Class 2)	High Frequency Type	
		High Permittivity (Class 2)	

#### [Test Methods and Remarks]

	Solder type	Solder temperature	Duration
Eutectic solder	H60A or H63A	230±5°C	4±1 sec.
Lead-free solder	Sn-3.0Ag-0.5Cu	245±3°C	

\* This catalog contains the typical specification only due to the limitation of space. When you consider purchase of our products, please check our specification. For details of each product (characteristics graph, reliability information, precautions for use, and so on), see our Web site (<http://www.ty-top.com/>) or CD catalogs.

## RELIABILITY DATA

### 13. Resistance to Soldering

Specified Value	Temperature Compensating (Class 1)	Standard	Appearance: No abnormality Capacitance change: Within $\pm 2.5\%$ or $\pm 0.25\text{pF}$ , whichever is larger. Q: Initial value Insulation resistance: Initial value Withstanding voltage (between terminals): No abnormality
		High Frequency Type	Appearance: No abnormality Capacitance change: Within $\pm 2.5\%$ Q: Initial value Insulation resistance: Initial value Withstanding voltage (between terminals): No abnormality
	High Permittivity (Class 2) Note 1	Appearance: No abnormality Capacitance change: Within $\pm 7.5\%$ (BJ, B7, C6, C7) Within $\pm 20\%$ (F) Dissipation factor: Initial value Insulation resistance: Initial value Withstanding voltage (between terminals): No abnormality	

[Test Methods and Remarks]

Class 1

	042, 063 Type	105 Type Array (096, 110 Type)
Preconditioning	None	
Preheating	150°C, 1 to 2 min.	80 to 100°C, 2 to 5 min. 150 to 200°C, 2 to 5 min.
Solder temperature	270 $\pm$ 5°C	
Duration	3 $\pm$ 0.5 sec.	
Recovery	6 to 24 hrs (Standard condition) Note 5	

Class 2

	042, 063 Type	105, 107, 212 Type Array (096, 110, 212 Type)	316, 325 Type
Preconditioning	Thermal treatment (at 150°C for 1 hr) Note 2		
Preheating	150°C, 1 to 2 min.	80 to 100°C, 2 to 5 min. 150 to 200°C, 2 to 5 min.	80 to 100°C, 5 to 10 min. 150 to 200°C, 5 to 10 min.
Solder temperature	270 $\pm$ 5°C		
Duration	3 $\pm$ 0.5 sec.		
Recovery	24 $\pm$ 2 hrs (Standard condition) Note 5		

### 14. Temperature Cycle (Thermal Shock)

Specified Value	Temperature Compensating (Class 1)	Standard	Appearance: No abnormality Capacitance change: Within $\pm 2.5\%$ or $\pm 0.25\text{pF}$ , whichever is larger. Q: Initial value Insulation resistance: Initial value Withstanding voltage (between terminals): No abnormality
		High Frequency Type	Appearance: No abnormality Capacitance change: Within $\pm 0.25\text{pF}$ Q: Initial value Insulation resistance: Initial value Withstanding voltage (between terminals): No abnormality
	High Permittivity (Class 2) Note 1	Appearance: No abnormality Capacitance change: Within $\pm 7.5\%$ (BJ, B7, C6, C7) Within $\pm 20\%$ (F) Dissipation factor: Initial value Insulation resistance: Initial value Withstanding voltage (between terminals): No abnormality	

[Test Methods and Remarks]

	Class 1	Class 2	
Preconditioning	None	Thermal treatment (at 150°C for 1 hr) Note 2	
1 cycle	Temperature (°C)		
	Step	Time (min.)	
	1	Minimum operating temperature +0/-3	30 $\pm$ 3
	2	Room temperature	2 to 3
	3	Maximum operating temperature +0/-3	30 $\pm$ 3
4	Room temperature	2 to 3	
Number of cycles	5 times		
Recovery	6 to 24 hrs (Standard condition) Note 5	24 $\pm$ 2 hrs (Standard condition) Note 5	

### 15. Humidity (Steady State)

Specified Value	Temperature Compensating (Class 1)	Standard	Appearance: No abnormality Capacitance change: Within $\pm 5\%$ or $\pm 0.5\text{pF}$ , whichever is larger. Q: C < 10pF : Q $\geq$ 200+10C 10 $\leq$ C < 30pF : Q $\geq$ 275+2.5C C $\geq$ 30pF : Q $\geq$ 350 (C : Nominal capacitance) Insulation resistance: 1000 M $\Omega$ min.
		High Frequency Type	Appearance: No abnormality Capacitance change: Within $\pm 0.5\text{pF}$ , Insulation resistance: 1000 M $\Omega$ min.
	High Permittivity (Class 2) Note 1	Appearance: No abnormality Capacitance change: Within $\pm 12.5\%$ (BJ, B7, C6, C7) Within $\pm 30\%$ (F) Dissipation factor : 5.0% max. (BJ, B7, C6, C7) 11.0% max. (F) Insulation resistance: 50 M $\Omega$ $\mu$ F or 1000 M $\Omega$ whichever is smaller.	

[Test Methods and Remarks]

Class 1

	Standard	High Frequency Type
Preconditioning	None	
Temperature	40 $\pm$ 2°C	60 $\pm$ 2°C
Humidity	90 to 95%RH	
Duration	500+24/-0 hrs	
Recovery	6 to 24 hrs (Standard condition) Note 5	

Class 2

	All items
Preconditioning	Thermal treatment (at 150°C for 1 hr) Note 2
Temperature	40 $\pm$ 2°C
Humidity	90 to 95%RH
Duration	500+24/-0 hrs
Recovery	24 $\pm$ 2 hrs (Standard condition) Note 5

\* This catalog contains the typical specification only due to the limitation of space. When you consider purchase of our products, please check our specification. For details of each product (characteristics graph, reliability information, precautions for use, and so on), see our Web site (<http://www.ty-top.com/>) or CD catalogs.



## RELIABILITY DATA

### 16. Humidity Loading

Specified Value	Temperature Compensating (Class 1)	Standard	Appearance: No abnormality Capacitance change: Within $\pm 7.5\%$ or $\pm 0.75\text{pF}$ , whichever is larger. Q : $C < 30\text{pF} : Q \geq 100 + 10C/3$ $C \geq 30\text{pF} : Q \geq 200$ (C : Nominal capacitance) Insulation resistance: 500 M $\Omega$ min.
		High Frequency Type	Appearance: No abnormality Capacitance change: $C \leq 2\text{pF} : \text{Within } \pm 0.4 \text{ pF}$ $C > 2\text{pF} : \text{Within } \pm 0.75 \text{ pF}$ (C : Nominal capacitance) Insulation resistance: 500 M $\Omega$ min.
	High Permittivity (Class 2) Note 1	Appearance: No abnormality Capacitance change: Within $\pm 12.5\%$ (BJ, B7, C6, C7) Within $\pm 30\%$ (F) Dissipation factor : 5.0% max. (BJ, B7, C6, C7) 11.0% max. (F) Insulation resistance: 25 M $\Omega\mu\text{F}$ or 500 M $\Omega$ , whichever is smaller.	

#### [Test Methods and Remarks]

Class 1		Class 2	
	Standard	High Frequency Type	All items
Preconditioning	None		Voltage treatment (Rated voltage are applied for 1 hour at 40°C) Note 3
Temperature	40 $\pm 2^\circ\text{C}$	60 $\pm 2^\circ\text{C}$	40 $\pm 2^\circ\text{C}$
Humidity	90 to 95%RH		90 to 95%RH
Duration	500+24/-0 hrs		500+24/-0 hrs
Applied voltage	Rated voltage		Rated voltage
Charge/discharge current	50mA max.		50mA max.
Recovery	6 to 24 hrs (Standard condition) Note 5		24 $\pm 2$ hrs (Standard condition) Note 5

### 17. High Temperature Loading

Specified Value	Temperature Compensating (Class 1)	Standard	Appearance: No abnormality Capacitance change: Within $\pm 3\%$ or $\pm 0.3\text{pF}$ , whichever is larger. Q : $C < 10\text{pF} : Q \geq 200 + 10C$ $10 \leq C < 30\text{pF} : Q \geq 275 + 2.5C$ $C \geq 30\text{pF} : Q \geq 350$ (C : Nominal capacitance) Insulation resistance: 1000 M $\Omega$ min.
		High Frequency Type	Appearance: No abnormality Capacitance change: Within $\pm 3\%$ or $\pm 0.3\text{pF}$ , whichever is larger. Insulation resistance: 1000 M $\Omega$ min.
	High Permittivity (Class 2) Note 1	Appearance: No abnormality Capacitance change: Within $\pm 12.5\%$ (BJ, B7, C6, C7) Within $\pm 30\%$ (F) Dissipation factor : 5.0% max. (BJ, B7, C6, C7) 11.0% max. (F) Insulation resistance: 50 M $\Omega\mu\text{F}$ or 1000 M $\Omega$ , whichever is smaller.	

#### [Test Methods and Remarks]

Class 1		Class 2			
	Standard	High Frequency Type	BJ, F	C6	B7, C7
Preconditioning	None		Voltage treatment (Twice the rated voltage shall be applied for 1 hour at 85°C, 105°C or 125°C) Note 3, 4		
Temperature	125 $\pm 3^\circ\text{C}$		85 $\pm 2^\circ\text{C}$	105 $\pm 3^\circ\text{C}$	125 $\pm 3^\circ\text{C}$
Duration	1000+48/-0 hrs		1000+48/-0 hrs		
Applied voltage	Rated voltage $\times 2$		Rated voltage $\times 2$ Note 4		
Charge/discharge current	50mA max.		50mA max.		
Recovery	6 to 24hr (Standard condition) Note 5		24 $\pm 2$ hrs (Standard condition) Note 5		

Note 1 The figures indicate typical specifications. Please refer to individual specifications in detail.

Note 2 Thermal treatment : Initial value shall be measured after test sample is heat-treated at 150+0/-10°C for an hour and kept at room temperature for 24 $\pm 2$ hours.

Note 3 Voltage treatment : Initial value shall be measured after test sample is voltage-treated for an hour at both the temperature and voltage specified in the test conditions, and kept at room temperature for 24 $\pm 2$ hours.

Note 4 Standard condition: Temperature: 5 to 35°C, Relative humidity: 45 to 85 % RH, Air pressure: 86 to 106kPa  
When there are questions concerning measurement results, in order to provide correlation data, the test shall be conducted under the following condition.  
Temperature: 20 $\pm 2^\circ\text{C}$ , Relative humidity: 60 to 70 % RH, Air pressure: 86 to 106kPa  
Unless otherwise specified, all the tests are conducted under the "standard condition".

\* This catalog contains the typical specification only due to the limitation of space. When you consider purchase of our products, please check our specification.  
For details of each product (characteristics graph, reliability information, precautions for use, and so on), see our Web site (<http://www.ty-top.com/>) or CD catalogs.

# PRECAUTIONS

## Precautions on the use of Multilayer Ceramic Capacitors

### 1. Circuit Design

◆ Verification of operating environment, electrical rating and performance  
 1. A malfunction of equipment in fields such as medical, aerospace, nuclear control, etc. may cause serious harm to human life or have severe social ramifications. Therefore, any capacitors to be used in such equipment may require higher safety and reliability, and shall be clearly differentiated from them used in general purpose applications.

◆ Operating Voltage (Verification of Rated voltage)  
 1. The operating voltage for capacitors must always be their rated voltage or less.  
 If an AC voltage is loaded on a DC voltage, the sum of the two peak voltages shall be the rated voltage or less.  
 For a circuit where an AC or a pulse voltage may be used, the sum of their peak voltages shall also be the rated voltage or less.  
 2. Even if an applied voltage is the rated voltage or less reliability of capacitors may be deteriorated in case that either a high frequency AC voltage or a pulse voltage having rapid rise time is used in a circuit.

### 2. PCB Design

◆ Pattern configurations (Design of Land-patterns)  
 1. When capacitors are mounted on PCBs, the amount of solder used (size of fillet) can directly affect the capacitor performance. Therefore, the following items must be carefully considered in the design of land patterns:  
 (1) Excessive solder applied can cause mechanical stresses which lead to chip breaking or cracking. Therefore, please consider appropriate land-patterns for proper amount of solder.  
 (2) When more than one component are jointly soldered onto the same land, each component's soldering point shall be separated by solder-resist.

◆ Pattern configurations (Capacitor layout on PCBs)  
 After capacitors are mounted on boards, they can be subjected to mechanical stresses in subsequent manufacturing processes (PCB cutting, board inspection, mounting of additional parts, assembly into the chassis, wave soldering of the boards, etc.). For this reason, land pattern configurations and positions of capacitors shall be carefully considered to minimize stresses.

◆ Pattern configurations (Design of Land-patterns)  
 The following diagrams and tables show some examples of recommended land patterns to prevent excessive solder amounts.

(1) Recommended land dimensions for typical chip capacitors

● Multilayer Ceramic Capacitors : Recommended land dimensions (unit: mm)

Wave-soldering

Type	107	212	316	325	
Size	L	1.6	2.0	3.2	3.2
	W	0.8	1.25	1.6	2.5
A	0.8 to 1.0	1.0 to 1.4	1.8 to 2.5	1.8 to 2.5	
B	0.5 to 0.8	0.8 to 1.5	0.8 to 1.7	0.8 to 1.7	
C	0.6 to 0.8	0.9 to 1.2	1.2 to 1.6	1.8 to 2.5	

Reflow-soldering

Type	042	063	105	107	212	316	325	432
Size	L	0.4	0.6	1.0	1.6	2.0	3.2	4.5
	W	0.2	0.3	0.5	0.8	1.25	1.6	2.5
A	0.15 to 0.25	0.20 to 0.30	0.45 to 0.55	0.8 to 1.0	0.8 to 1.2	1.8 to 2.5	1.8 to 2.5	2.5 to 3.5
B	0.15 to 0.20	0.20 to 0.30	0.40 to 0.50	0.6 to 0.8	0.8 to 1.2	1.0 to 1.5	1.0 to 1.5	1.5 to 1.8
C	0.15 to 0.30	0.25 to 0.40	0.45 to 0.55	0.6 to 0.8	0.9 to 1.6	1.2 to 2.0	1.8 to 3.2	2.3 to 3.5

● LWDC: Recommended land dimensions for reflow-soldering (unit: mm)



Type	105	107	212	
Size	L	0.52	0.8	1.25
	W	1.0	1.6	2.0
A	0.18 to 0.22	0.25 to 0.3	0.5 to 0.7	
B	0.2 to 0.25	0.3 to 0.4	0.4 to 0.5	
C	0.9 to 1.1	1.5 to 1.7	1.9 to 2.1	

(unit: mm)

● Array type: Recommended land dimensions for reflow-soldering (unit: mm)

Type	096 (2 circuits)	110 (2 circuits)	212 (2 circuits)	212 (4 circuits)	
Size	L	0.9	1.37	2.0	2.0
	W	0.6	1.0	1.25	1.25
a	0.25 to 0.35	0.35 to 0.45	0.5 to 0.6	0.5 to 0.6	
b	0.15 to 0.25	0.55 to 0.65	0.5 to 0.6	0.5 to 0.6	
c	0.15 to 0.25	0.3 to 0.4	0.5 to 0.6	0.2 to 0.3	
d	0.45	0.64	1.0	0.5	

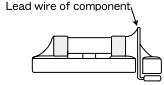
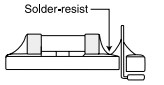
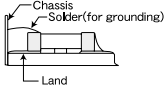
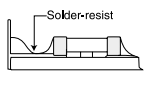
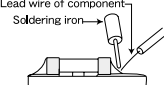
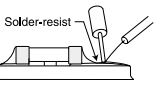
(2) Examples of good and bad solder application

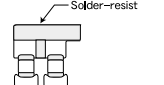
Items	Not recommended	Recommended
Mixed mounting of SMD and leaded components		
Component placement close to the chassis		
Hand-soldering of leaded components near mounted components		
Horizontal component placement		

Land patterns for PCBs

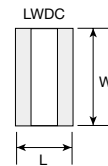
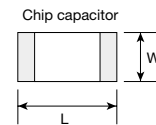
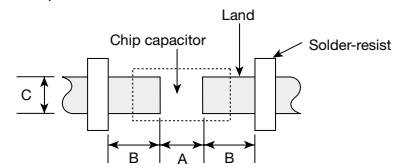

2 circuits

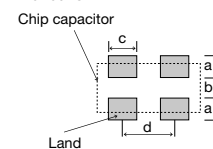

4 circuits

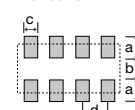

Technical considerations

To next page

\* This catalog contains the typical specification only due to the limitation of space. When you consider purchase of our products, please check our specification. For details of each product (characteristics graph, reliability information, precautions for use, and so on), see our Web site (<http://www.ty-top.com/>) or CD catalogs.

## PRECAUTIONS

### Precautions on the use of Multilayer Ceramic Capacitors

#### 2. PCB Design

##### ◆Pattern configurations (Capacitor layout on PCBs)

1-1. The following are examples of good and bad capacitor layouts; capacitors shall be located to minimize any possible mechanical stresses from board warp or deflection.

Items	Not recommended	Recommended
Deflection of board		 Position the component at a right angle to the direction of the mechanical stresses that are anticipated.

Technical considerations

1-2. The amount of mechanical stresses given will vary depending on capacitor layout. Please refer to diagram below.

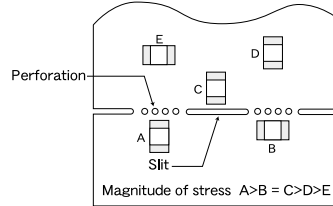

1-3. When PCB is split, the amount of mechanical stress on the capacitors can vary according to the method used. The following methods are listed in order from least stressful to most stressful: push-back, slit, V-grooving, and perforation. Thus, please consider the PCB split methods as well as chip location.

#### 3. Mounting

##### ◆Adjustment of mounting machine

- When capacitors are mounted on PCB, excessive impact load shall not be imposed on them.
- Maintenance and inspection of mounting machines shall be conducted periodically.

Precautions

##### ◆Selection of Adhesives

- When chips are attached on PCBs with adhesives prior to soldering, it may cause capacitor characteristics degradation unless the following factors are appropriately checked: size of land patterns, type of adhesive, amount applied, hardening temperature and hardening period. Therefore, please contact us for further information.

##### ◆Adjustment of mounting machine

- When the bottom dead center of a pick-up nozzle is too low, excessive force is imposed on capacitors and causes damages. To avoid this, the following points shall be considerable.
  - The bottom dead center of the pick-up nozzle shall be adjusted to the surface level of PCB without the board deflection.
  - The pressure of nozzle shall be adjusted between 1 and 3 N static loads.
  - To reduce the amount of deflection of the board caused by impact of the pick-up nozzle, supporting pins or back-up pins shall be used on the other side of the PCB. The following diagrams show some typical examples of good and bad pick-up nozzle placement:

Items	Not recommended	Recommended
Single-sided mounting		
Double-sided mounting		

Technical considerations

- As the alignment pin is worn out, adjustment of the nozzle height can cause chipping or cracking of capacitors because of mechanical impact on the capacitors. To avoid this, the monitoring of the width between the alignment pins in the stopped position, maintenance, check and replacement of the pin shall be conducted periodically.

##### ◆Selection of Adhesives

Some adhesives may cause IR deterioration. The different shrinkage percentage of between the adhesive and the capacitors may result in stresses on the capacitors and lead to cracking. Moreover, too little or too much adhesive applied to the board may adversely affect components. Therefore, the following precautions shall be noted in the application of adhesives.

- Required adhesive characteristics
  - The adhesive shall be strong enough to hold parts on the board during the mounting & solder process.
  - The adhesive shall have sufficient strength at high temperatures.
  - The adhesive shall have good coating and thickness consistency.
  - The adhesive shall be used during its prescribed shelf life.
  - The adhesive shall harden rapidly.
  - The adhesive shall have corrosion resistance.
  - The adhesive shall have excellent insulation characteristics.
  - The adhesive shall have no emission of toxic gasses and no effect on the human body.
- The recommended amount of adhesives is as follows;

[Recommended condition]

Figure	212/316 case sizes as examples
a	0.3mm min
b	100 to 120 μm
c	Adhesives shall not contact land

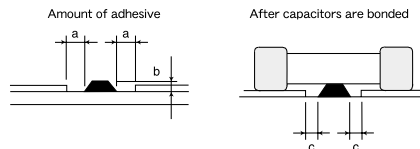

\* This catalog contains the typical specification only due to the limitation of space. When you consider purchase of our products, please check our specification. For details of each product (characteristics graph, reliability information, precautions for use, and so on), see our Web site (<http://www.ty-top.com/>) or CD catalogs.

# PRECAUTIONS

## Precautions on the use of Multilayer Ceramic Capacitors

### 4. Soldering

**◆ Selection of Flux**  
 Since flux may have a significant effect on the performance of capacitors, it is necessary to verify the following conditions prior to use;  
 (1) Flux used shall be less than or equal to 0.1 wt% (in Cl equivalent) of halogenated content. Flux having a strong acidity content shall not be applied.  
 (2) When shall capacitors are soldered on boards, the amount of flux applied shall be controlled at the optimum level.  
 (3) When water-soluble flux is used, special care shall be taken to properly clean the boards.

**◆ Soldering**  
 Temperature, time, amount of solder, etc. shall be set in accordance with their recommended conditions.

Sn-Zn solder paste can adversely affect MLCC reliability.  
 Please contact us prior to usage of Sn-Zn solder.

**◆ Selection of Flux**  
 1-1. When too much halogenated substance (Chlorine, etc.) content is used to activate flux, or highly acidic flux is used, it may lead to corrosion of terminal electrodes or degradation of insulation resistance on the surfaces of the capacitors.  
 1-2. Flux is used to increase solderability in wave soldering. However if too much flux is applied, a large amount of flux gas may be emitted and may adversely affect the solderability. To minimize the amount of flux applied, it is recommended to use a flux-bubbling system.  
 1-3. Since the residue of water-soluble flux is easily dissolved in moisture in the air, the residues on the surfaces of capacitors in high humidity conditions may cause a degradation of insulation resistance and reliability of the capacitors. Therefore, the cleaning methods and the capability of the machines used shall also be considered carefully when water-soluble flux is used.

**◆ Soldering**

- Ceramic chip capacitors are susceptible to thermal shock when exposed to rapid or concentrated heating or rapid cooling.
- Therefore, the soldering must be conducted with great care so as to prevent malfunction of the components due to excessive thermal shock.
- Preheating : Capacitors shall be preheated sufficiently, and the temperature difference between the capacitors and solder shall be within 100 to 130°C.
- Cooling : The temperature difference between the capacitors and cleaning process shall not be greater than 100°C.

[Reflow soldering]

[Recommended conditions for eutectic soldering]

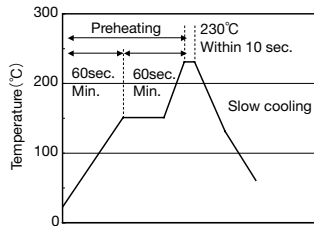

[Recommended condition for Pb-free soldering]

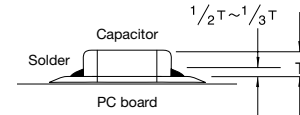
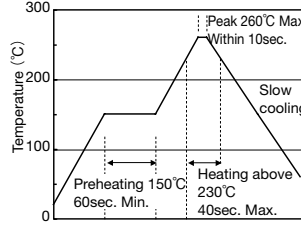

Caution

- ① The ideal condition is to have solder mass (fillet) controlled to 1/2 to 1/3 of the thickness of a capacitor.
- ② Because excessive dwell times can adversely affect solderability, soldering duration shall be kept as close to recommended times as possible.

Technical considerations

[Wave soldering]

[Recommended conditions for eutectic soldering]

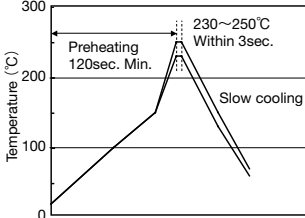

[Recommended condition for Pb-free soldering]

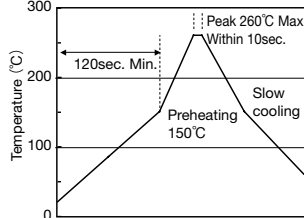

Caution

- ① Wave soldering must not be applied to capacitors designated as for reflow soldering only.

[Hand soldering]

[Recommended conditions for eutectic soldering]

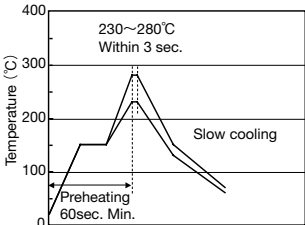

[Recommended condition for Pb-free soldering]

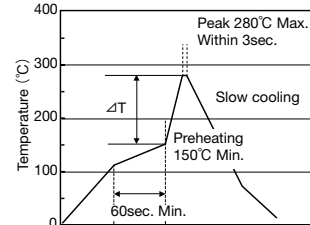
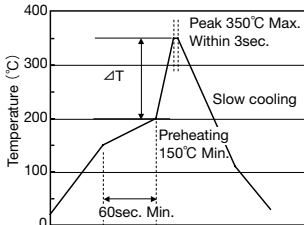

Caution

- ① Use a 50W soldering iron with a maximum tip diameter of 1.0 mm.
- ② The soldering iron shall not directly touch capacitors.

\* This catalog contains the typical specification only due to the limitation of space. When you consider purchase of our products, please check our specification. For details of each product (characteristics graph, reliability information, precautions for use, and so on), see our Web site (<http://www.ty-top.com/>) or CD catalogs.

## ■ PRECAUTIONS

### Precautions on the use of Multilayer Ceramic Capacitors

5. Cleaning	
Precautions	<ul style="list-style-type: none"> <li>◆Cleaning conditions</li> <li>1. When PCBs are cleaned after capacitors mounting, Please select the appropriate cleaning solution in accordance with the intended use of the cleaning. (e.g. to remove soldering flux or other materials from the production process.)</li> <li>2. Cleaning condition shall be determined after it is verified by using actual cleaning machine that the cleaning process does not affect capacitor's characteristics.</li> </ul>
Technical considerations	<ul style="list-style-type: none"> <li>1. The use of inappropriate cleaning solutions can cause foreign substances such as flux residue to adhere to capacitors or deteriorate their outer coating, resulting in a degradation of the capacitor's electrical properties (especially insulation resistance).</li> <li>2. Inappropriate cleaning conditions (insufficient or excessive cleaning) may adversely affect the performance of the capacitors.</li> </ul> <p>In the case of ultrasonic cleaning, too much power output can cause excessive vibration of PCBs which may lead to the cracking of capacitors or the soldered portion, or decrease the terminal electrodes' strength. Therefore, the following conditions shall be carefully checked;</p> <ul style="list-style-type: none"> <li>Ultrasonic output : 20 W/l or less</li> <li>Ultrasonic frequency : 40 kHz or less</li> <li>Ultrasonic washing period : 5 min. or less</li> </ul>
6. Resin coating and mold	
Precautions	<ul style="list-style-type: none"> <li>1. With some type of resins, decomposition gas or chemical reaction vapor may remain inside the resin during the hardening period or while left under normal storage conditions resulting in the deterioration of the capacitor's performance.</li> <li>2. When a resin's hardening temperature is higher than capacitor's operating temperature, the stresses generated by the excessive heat may lead to damage or destruction of capacitors.</li> </ul> <p>The use of such resins, molding materials etc. is not recommended.</p>
7. Handling	
Precautions	<ul style="list-style-type: none"> <li>◆Splitting of PCB</li> <li>1. When PCBs are split after components mounting, care shall be taken so as not to give any stresses of deflection or twisting to the board.</li> <li>2. Board separation shall not be done manually, but by using the appropriate devices.</li> </ul> <ul style="list-style-type: none"> <li>◆Mechanical considerations</li> <li>Be careful not to subject capacitors to excessive mechanical shocks.</li> <li>(1) If ceramic capacitors are dropped onto a floor or a hard surface, they shall not be used.</li> <li>(2) Please be careful that the mounted components do not come in contact with or bump against other boards or components.</li> </ul>
8. Storage conditions	
Precautions	<ul style="list-style-type: none"> <li>◆Storage</li> <li>1. To maintain the solderability of terminal electrodes and to keep packaging materials in good condition, care must be taken to control temperature and humidity in the storage area. Humidity should especially be kept as low as possible. <ul style="list-style-type: none"> <li>•Recommended conditions</li> <li style="padding-left: 40px;">Ambient temperature : Below 30°C</li> <li style="padding-left: 40px;">Humidity : Below 70% RH</li> </ul> <p>The ambient temperature must be kept below 40°C. Even under ideal storage conditions, solderability of capacitor is deteriorated as time passes, so capacitors shall be used within 6 months from the time of delivery.</p> <li>•Ceramic chip capacitors shall be kept where no chlorine or sulfur exists in the air.</li> </li></ul> <li>2. The capacitance values of high dielectric constant capacitors will gradually decrease with the passage of time, So care shall be taken to design circuits. Even if capacitance value decreases as time passes, it will get back to the initial value by a heat treatment at 150°C for 1hour.</li>
Technical considerations	<p>If capacitors are stored in a high temperature and humidity environment, it might rapidly cause poor solderability due to terminal oxidation and quality loss of taping/packaging materials. For this reason, capacitors shall be used within 6 months from the time of delivery. If exceeding the above period, please check solderability before using the capacitors.</p>

\* This catalog contains the typical specification only due to the limitation of space. When you consider purchase of our products, please check our specification.  
For details of each product (characteristics graph, reliability information, precautions for use, and so on), see our Web site (<http://www.ty-top.com/>) or CD catalogs.