

3.3 V Zero Delay Buffer

The MPC962308 is a 3.3 V Zero Delay Buffer designed to distribute high-speed clocks in PC, workstation, datacom, telecom and other high-performance applications. The MPC962308 uses an internal PLL and an external feedback path to lock its low-skew clock output phase to the reference clock phase, providing virtually zero propagation delay. The input-to-output skew is guaranteed to be less than 250 ps and output-to-output skew is guaranteed to be less than 200 ps.

Features

- 1:8 outputs LVCMOS zero-delay buffer
- Zero input-output propagation delay, adjustable by the capacitive load on FBK input
- Multiple Configurations, see [Table 2. Available MPC962308 Configurations](#)
- Multiple low-skew outputs
- 200 ps max output-output skew
- 700 ps max device-device skew
- Two banks of four outputs, output tristate control by two select inputs
- Supports a clock I/O frequency range of 10 MHz to 133 MHz
- Low jitter, 200 ps max cycle-cycle (-1, -1H, -4, -5H)
- ± 250 ps static phase offset (SPO)
- 16-pin SOIC package or 16-pin TSSOP package
- Single 3.3 V supply
- Ambient temperature range: -40°C to $+85^{\circ}\text{C}$
- Compatible with the CY2308 and CY23S08
- Spread spectrum compatible

Functional Description

The MPC962308 has two banks of four outputs each which can be controlled by the select inputs as shown in [Table 1. Select Input Decoding](#). Bank B can be tristated if all of the outputs are not required. The select inputs also allow the input clock to be directly applied to the output for chip and system testing purposes. The MPC962308 PLL enters a power down state when there are no rising edges on the REF input. During this state, all of the outputs are in tristate and there is less than 50 μA of current draw. The PLL shuts down in two additional cases explained in [Table 1. Select Input Decoding](#).

Multiple MPC962308 devices can accept and distribute the same input clock throughout the system. In this situation, the difference between the output skews of two devices will be less than 700 ps.

The MPC962308 is available in five different configurations as shown in [Table 2. Available MPC962308 Configurations](#). In the MPC962308-1, the reference frequency is reproduced by the PLL and provided at the outputs. A high drive version of this configuration, the MPC962308-1H, is available to provide faster rise and fall times of the device.

The MPC962308-2 provides 2X and 1X the reference frequency at the output banks. In addition, the MPC962308-3 provides 4X and 2X the reference frequency at the output banks. The output banks driving the feedback will determine the different configurations of the above devices. The MPC962308-4 provides outputs 2X the reference frequency. The MPC962308-5H is a high drive version with outputs of REF/2.

The MPC962308 is fully 3.3 V compatible and requires no external components for the internal PLL. All inputs accept LVCMOS signals while the outputs provide LVCMOS compatible levels with the capability to drive terminated 50 Ω transmission lines on the incident edge. Depending on the configuration, the device is offered in a 16-lead SOIC or 16-lead TSSOP package.

MPC962308

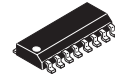

D SUFFIX
16-LEAD SOIC PACKAGE
CASE 751B-05

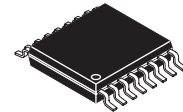

DT SUFFIX
16-LEAD TSSOP PACKAGE
CASE 948F-01

Block Diagram

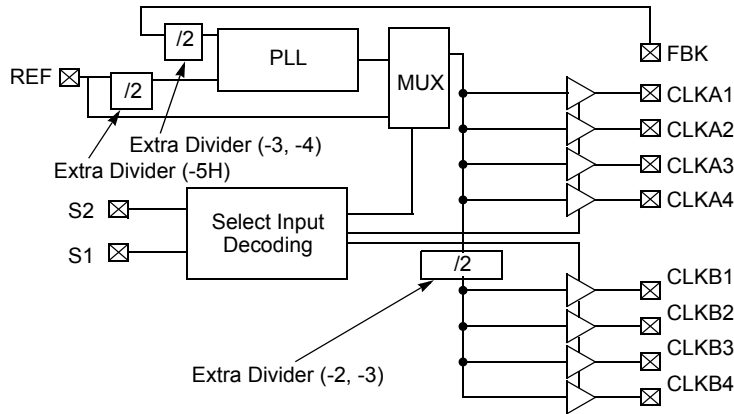

Pin Configuration

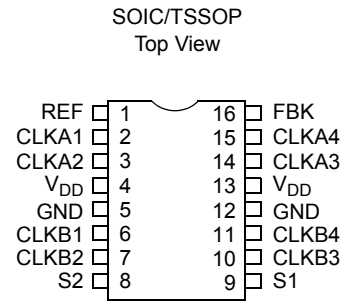

Table 1. Select Input Decoding

S2	S1	CLOCK A1—A4	CLOCK B1—B4	Output Source	PLL Shutdown
0	0	Three-State	Three-State	PLL	Y
0	1	Driven	Three-State	PLL	N
1	0	Driven ¹	Driven ¹	Reference	Y
1	1	Driven	Driven	PLL	N

1. Outputs inverted on MPC962308-2 in bypass mode, S2=1 and S1=0.

Table 2. Available MPC962308 Configurations

Device	Feedback From	Bank A Frequency	Bank B Frequency
MPC962308-1	Bank A or Bank B	Reference	Reference
MPC962308-1H	Bank A or Bank B	Reference	Reference
MPC962308-2	Bank A	Reference	Reference/2
MPC962308-2	Bank B	2 X Reference	Reference
MPC962308-3	Bank A	2 X Reference	Reference or Reference ^[1]
MPC962308-3	Bank B	4 X Reference	2 X Reference
MPC962308-4	Bank A or Bank B	2 X Reference	2 X Reference
MPC962308-5H	Bank A or Bank B	Reference /2	Reference /2

1. Output phase is indeterminate (0° or 180° from input clock). If phase integrity is required, use the MPC962308-2.

Freescale Semiconductor, Inc.

Table 3. Pin Description

Pin	Signal	Description
1	REF ¹	Input reference frequency, 5 V tolerant input
2	CLKA1 ²	Clock output, Bank A
3	CLKA2 ²	Clock output, Bank A
4	V _{DD}	3.3 V supply
5	GND	Ground
6	CLKB1 ²	Clock output, Bank B
7	CLKB2 ²	Clock output, Bank B
8	S2 ³	Select input, bit 2
9	S1 ³	Select input, bit 1
10	CLKB3 ²	Clock output, Bank B
11	CLKB4 ²	Clock output, Bank B
12	GND	Ground
13	V _{DD}	3.3 V supply
14	CLKA3 ²	Clock output, Bank A
15	CLKA4 ²	Clock output, Bank A
16	FBK	PLL feedback input

1. Weak pull-down.
2. Weak pull-down on all outputs.
3. Weak pull-ups on these inputs.

Table 4. Maximum Ratings

Characteristics	Value	Unit
Supply Voltage to Ground Potential	-0.5 to +3.9	V
DC Input Voltage (Except REF)	-0.5 to V _{DD} +0.5	V
DC Input Voltage REF	-0.5 to 5.5	V
Storage Temperature	-65 to +150	°C
Junction	150	°C
Static Discharge Voltage (per MIL-STD-883, Method 3015)	>2000	V

Table 5. Operating Conditions for MPC962308-X Industrial Temperature Devices

Parameter	Description	Min	Max	Unit
V _{DD}	Supply Voltage	3.0	3.6	V
T _A	Operating Temperature (Ambient Temperature)	-40	85	°C
C _L	Load Capacitance, below 100 MHz		30	pF
	Load Capacitance, from 100 MHz to 133 MHz		15	pF
C _{IN}	Input Capacitance ¹		7	pF

1. Applies to both REF clock and FBK.

Table 6. Electrical Characteristics for MPC962308-X Industrial Temperature Devices¹

Parameter	Description	Test Conditions	Min	Max	Unit
V _{IL}	Input LOW Voltage			0.8	V
V _{IH}	Input HIGH Voltage		2.0		V
I _{IL}	Input LOW Current	V _{IN} = 0V		50.0	μA
I _{IH}	Input HIGH Current	V _{IN} = V _{DD}		100.0	μA
V _{OL}	Output LOW Voltage ²	I _{OL} = 8 mA (-1, -2, -3, -4) I _{OL} = 12 mA (-1H, -5H)		0.4	V
V _{OH}	Output HIGH Voltage ²	I _{OH} = -8 mA (-1, -2, -3, -4) I _{OH} = -12 mA (-1H, -5H)	2.4		V
I _{DD} (PD mode)	Power Down Supply Current	REF = 0 MHz		25.0	μA
I _{DD}	Supply Current	Unloaded outputs, 100 MHz, Select inputs at V _{DD} or GND		45.0	mA
				70(-1H, -5H)	mA
		Unloaded outputs, 66-MHz REF (-1, -2, -3, -4)		35.0	mA
		Unloaded outputs, 35-MHz REF (-1, -2, -3, -4)		20.0	mA

1. All parameters are specified with loaded outputs.

2. Parameter is guaranteed by design and characterization. Not 100% tested in production.

Freescale Semiconductor, Inc.

Table 7. Switching Characteristics for MPC962308-X Industrial Temperature Devices¹

Parameter	Name	Test Conditions	Min	Typ	Max	Unit
t ₁	Output Frequency	30-pF load, All devices	10		100	MHz
t ₁	Output Frequency ²	20-pF load, -1H, -5H devices	10		133.3	MHz
t ₁	Output Frequency ²	15-pF load, -1, -2, -3, -4 devices	10		133.3	MHz
	Duty Cycle ² = t ₂ ÷ t ₁ (-1, -2, -3, -4, -1H, -5H)	Measured at 1.4 V, FOUT =66.66 MHz 30-pF load	40.0		60.0	%
	Duty Cycle ² = t ₂ ÷ t ₁ (-1, -2, -3, -4, -1H, -5H)	Measured at 1.4 V, FOUT <50.0 MHz 15-pF load	45.0		55.0	%
t ₃	Rise Time ² (-1, -2, -3, -4)	Measured between 0.8 V and 2.0 V, 30-pF load			2.50	ns
	Rise Time ² (-1, -2, -3, -4)	Measured between 0.8 V and 2.0 V, 15-pF load			1.50	ns
	Rise Time ² (-1H, -5H)	Measured between 0.8 V and 2.0 V, 30-pF load			1.50	ns
t ₄	Fall Time ² (-1, -2, -3, -4)	Measured between 0.8 V and 2.0 V, 30-pF load			2.50	ns
	Fall Time ² (-1, -2, -3, -4)	Measured between 0.8 V and 2.0 V, 15-pF load			1.50	ns
	Fall Time ² (-1H, -5H)	Measured between 0.8 V and 2.0 V, 30-pF load			1.25	ns
	Output-to-Output Skew on same Bank (-1, -2, -3, -4) ²	All outputs equally loaded			200	ps
t ₅	Output-to-Output Skew (-1H, -5H)	All outputs equally loaded			200	ps
	Output Bank A to Output Bank B Skew (-1, -4, -5H)	All outputs equally loaded			200	ps
	Output Bank A to Output Bank B Skew (-2, -3)	All outputs equally loaded			400	ps
t ₆	Delay, REF Rising Edge to FBK Rising Edge ²	Measured at V _{DD} /2		0	±250	ps
t ₇	Device-to-Device Skew ²	Measured at V _{DD} /2 on the FBK pins of devices		0	700	ps
t ₈	Output Slew Rate ²	Measured between 0.8 V and 2.0 V on -1H, -5H device using Test Circuit # 2	1			V/ns
t _J	Cycle-to-Cycle Jitter (-1, -1H, -4, -5H) ²	Measured at 66.67 MHz, loaded outputs, 15-pF load			200	ps
		Measured at 66.67 MHz, loaded outputs, 30-pF load			200	ps
		Measured at 133.3 MHz, loaded outputs, 15 pF load			100	ps
t _J	Cycle-to-Cycle Jitter (-2, -3) ²	Measured at 66.67 MHz, loaded outputs 30-pF load			400	ps
		Measured at 66.67 MHz, loaded outputs 15-pF load			400	ps
t _{LOCK}	PLL Lock Time ²	Stable power supply, valid clocks presented on REF and FBK pins			1.0	ms

1. All parameters are specified with loaded outputs.

2. Parameter is guaranteed by design and characterization. Not 100% tested in production.

APPLICATIONS INFORMATION

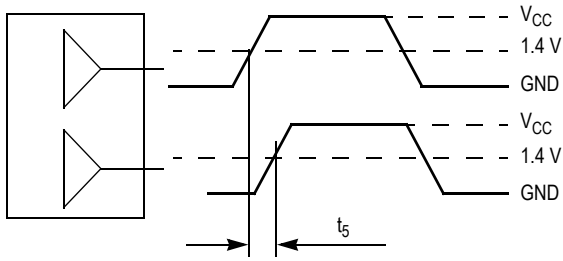

The pin-to-pin skew is defined as the worst case difference in propagation delay between any similar delay path within a single device

Figure 1. Output-to-Output Skew $t_{SK(O)}$

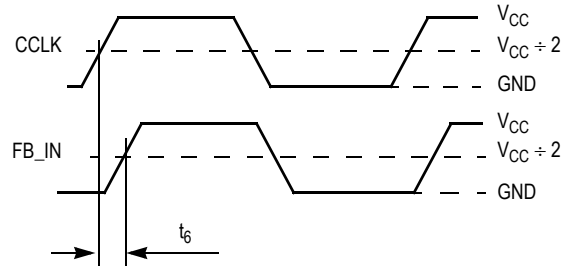
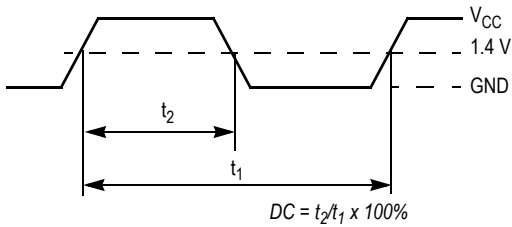

Figure 2. Static Phase Offset Test Reference



The time from the PLL controlled edge to the non-controlled edge, divided by the time between PLL controlled edges, expressed as a percentage

Figure 3. Output Duty Cycle (DC)

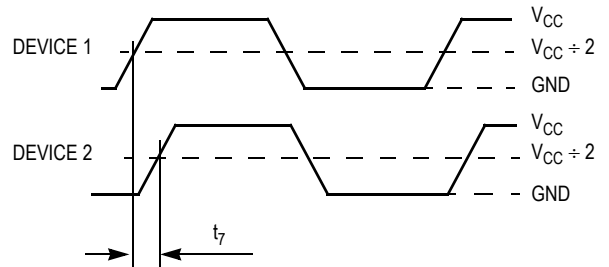
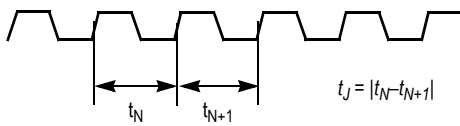

Figure 4. Device-to-Device Skew



The variation in cycle time of a signal between adjacent cycles, over a random sample of adjacent cycle pairs

Figure 5. Cycle-to-Cycle Jitter

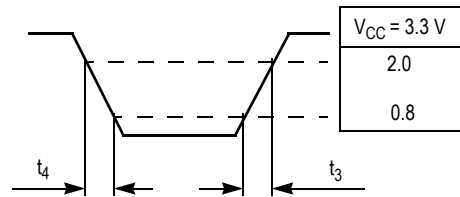
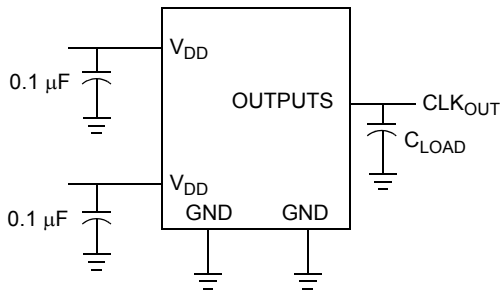

Figure 6. Output Transition Time Test Reference

Freescale Semiconductor, Inc.

Test Circuit #1



Test Circuit for all parameters except t_8

Test Circuit #2

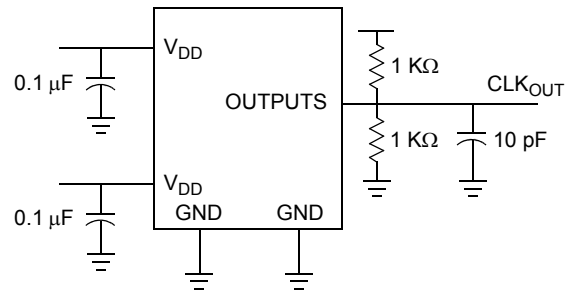

Test Circuit for t_8 , Output slew rate on -1H, -5 device

Ordering Information (Available)

Ordering Code	Package Name	Package Type
MPC962308D-1	D16	16-pin 150-mil SOIC
MPC962308D-1R2	D16	16-pin 150-mil SOIC — Tape and Reel
MPC962308D-1H	D16	16-pin 150-mil SOIC
MPC962308D-1HR2	D16	16-pin 150-mil SOIC — Tape and Reel
MPC962308DT-1H	DT16	16-pin 150-mil TSSOP
MPC962308DT-1HR2	DT16	16-pin 150-mil TSSOP — Tape and Reel
MPC962308D-2	D16	16-pin 150-mil SOIC
MPC962308D-2R2	D16	16-pin 150-mil SOIC — Tape and Reel

Ordering Information (Planned)

Ordering Code	Package Name	Package Type
MPC962308D-3	D16	16-pin 150-mil SOIC
MPC962308D-3R2	D16	16-pin 150-mil SOIC — Tape and Reel
MPC962308D-4	D16	16-pin 150-mil SOIC
MPC962308D-4R2	D16	16-pin 150-mil SOIC — Tape and Reel
MPC962308D-5H	D16	16-pin 150-mil SOIC
MPC962308D-5HR2	D16	16-pin 150-mil SOIC — Tape and Reel
MPC962308DT-5H	DT16	16-pin 150-mil TSSOP
MPC962308DT-5HR2	DT16	16-pin 150-mil TSSOP — Tape and Reel

PACKAGE DIMENSIONS

D SUFFIX

16 LEAD SOIC PACKAGE
CASE 751B-05
ISSUE K

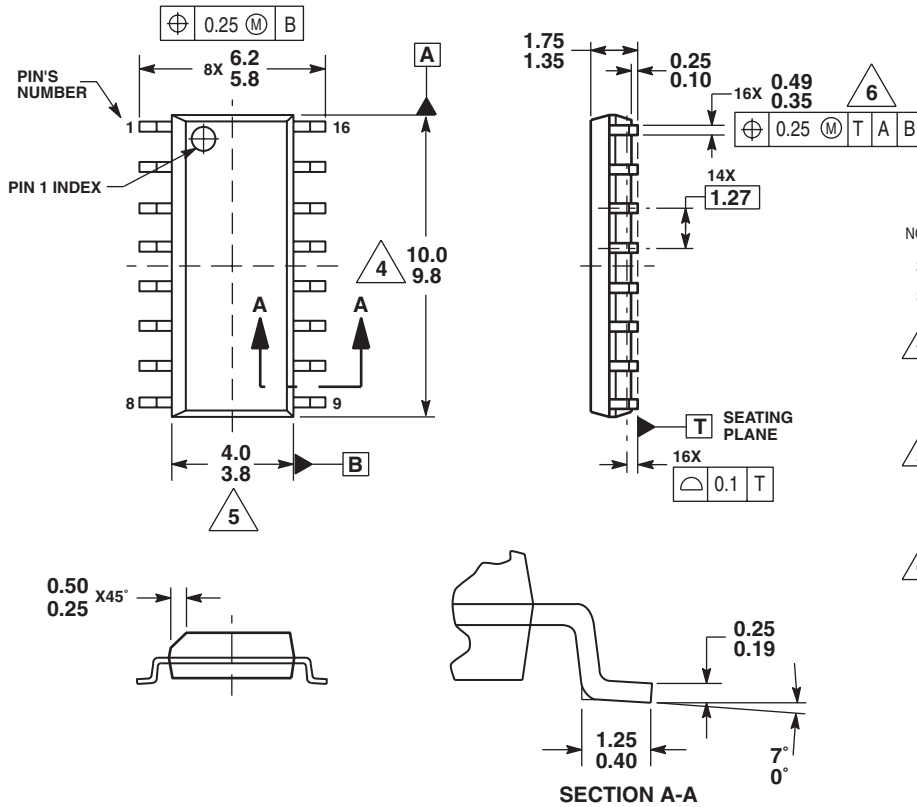

- NOTES:
1. DIMENSIONS ARE IN MILLIMETERS.
 2. DIMENSIONING AND TOLERANCING PER ASME Y14.5M, 1994.
 3. DATUMS A AND B TO BE DETERMINED AT THE PLANE WHERE THE BOTTOM OF THE LEADS EXIT THE PLASTIC BODY.
 4. THIS DIMENSION DOES NOT INCLUDE MOLD FLASH, PROTRUSION OR GATE BURRS. MOLD FLASH, PROTRUSION OR GATE BURRS SHALL NOT EXCEED 0.15MM PER SIDE. THIS DIMENSION IS DETERMINED AT THE PLANE WHERE THE BOTTOM OF THE LEADS EXIT THE PLASTIC BODY.
 5. THIS DIMENSION DOES NOT INCLUDE INTER-LEAD FLASH OR PROTRUSIONS. INTER-LEAD FLASH AND PROTRUSIONS SHALL NOT EXCEED 0.25MM PER SIDE. THIS DIMENSION IS DETERMINED AT THE PLANE WHERE THE BOTTOM OF THE LEADS EXIT THE PLASTIC BODY.
 6. THIS DIMENSION DOES NOT INCLUDE DAMBAR PROTRUSION. ALLOWABLE DAMBAR PROTRUSION SHALL NOT CAUSE THE LEAD WIDTH TO EXCEED 0.62MM.

Freescale Semiconductor, Inc.

PACKAGE DIMENSIONS

DT SUFFIX

16 LEAD TSSOP PACKAGE
CASE 948F-01
ISSUE O

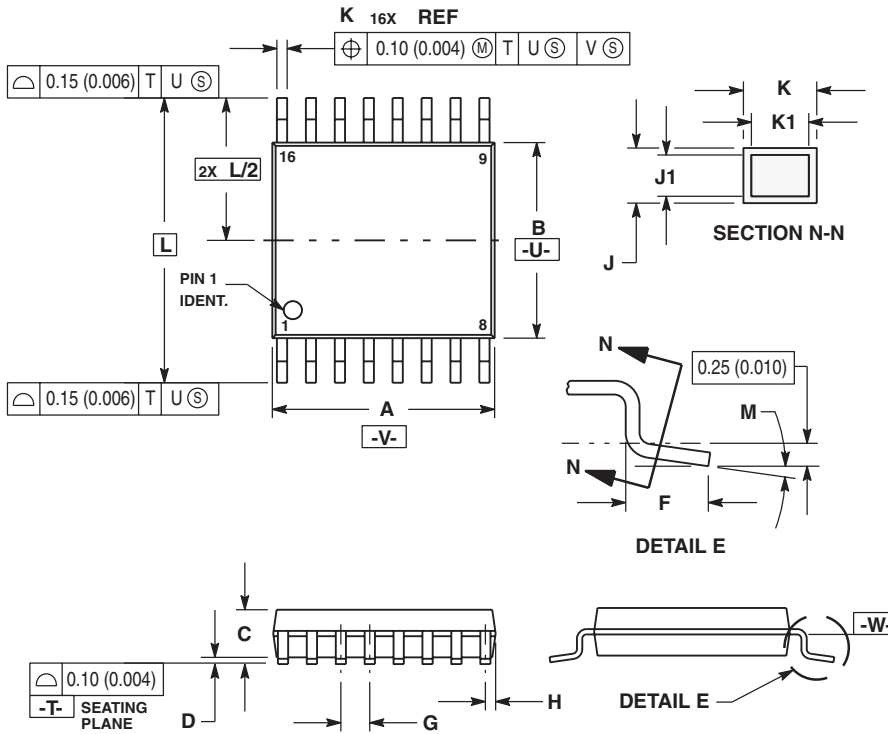

- NOTES:
1. DIMENSIONING AND TOLERANCING PER ANSI Y14.5M, 1982.
 2. CONTROLLING DIMENSION: MILLIMETER.
 3. DIMENSION A DOES NOT INCLUDE MOLD FLASH, PROTRUSIONS OR GATE BURRS. MOLD FLASH OR GATE BURRS SHALL NOT EXCEED 0.15 (0.006) PER SIDE.
 4. DIMENSION B DOES NOT INCLUDE INTERLEAD FLASH OR PROTRUSION. INTERLEAD FLASH OR PROTRUSION SHALL NOT EXCEED 0.25 (0.010) PER SIDE.
 5. DIMENSION K DOES NOT INCLUDE DAMBAR PROTRUSION. ALLOWABLE DAMBAR PROTRUSION SHALL BE 0.08 (0.003) TOTAL IN EXCESS OF THE K DIMENSION AT MAXIMUM MATERIAL CONDITION.
 6. TERMINAL NUMBERS ARE SHOWN FOR REFERENCE ONLY.
 7. DIMENSION A AND B ARE TO BE DETERMINED AT DATUM PLANE -W-.

DIM	MILLIMETERS		INCHES	
	MIN	MAX	MIN	MAX
A	4.90	5.10	0.193	0.200
B	4.30	4.50	0.169	0.177
C	---	1.20	---	0.047
D	0.05	0.15	0.002	0.006
F	0.50	0.75	0.020	0.030
G	0.65 BSC		0.026 BSC	
H	0.18	0.28	0.007	0.011
J	0.09	0.20	0.004	0.008
J1	0.09	0.16	0.004	0.006
K	0.19	0.30	0.007	0.012
K1	0.19	0.25	0.007	0.010
L	6.40 BSC		0.252 BSC	
M	0"	8"	0"	8"

Freescale Semiconductor, Inc.

NOTES

Freescale Semiconductor, Inc.

NOTES

Information in this document is provided solely to enable system and software implementers to use Motorola products. There are no express or implied copyright licenses granted hereunder to design or fabricate any integrated circuits or integrated circuits based on the information in this document.

Motorola reserves the right to make changes without further notice to any products herein. Motorola makes no warranty, representation or guarantee regarding the suitability of its products for any particular purpose, nor does Motorola assume any liability arising out of the application or use of any product or circuit, and specifically disclaims any and all liability, including without limitation consequential or incidental damages. "Typical" parameters which may be provided in Motorola data sheets and/or specifications can and do vary in different applications and actual performance may vary over time. All operating parameters, including "Typicals" must be validated for each customer application by customer's technical experts. Motorola does not convey any license under its patent rights nor the rights of others. Motorola products are not designed, intended, or authorized for use as components in systems intended for surgical implant into the body, or other applications intended to support or sustain life, or for any other application in which the failure of the Motorola product could create a situation where personal injury or death may occur. Should Buyer purchase or use Motorola products for any such unintended or unauthorized application, Buyer shall indemnify and hold Motorola and its officers, employees, subsidiaries, affiliates, and distributors harmless against all claims, costs, damages, and expenses, and reasonable attorney fees arising out of, directly or indirectly, any claim of personal injury or death associated with such unintended or unauthorized use, even if such claim alleges that Motorola was negligent regarding the design or manufacture of the part.

MOTOROLA and the Stylized M Logo are registered in the US Patent and Trademark Office. All other product or service names are the property of their respective owners.

© Motorola, Inc. 2004

HOW TO REACH US:

USA/EUROPE/LOCATIONS NOT LISTED:
Motorola Literature Distribution
P.O. Box 5405, Denver, Colorado 80217
1-800-521-6274 or 480-768-2130

JAPAN: Motorola Japan Ltd.; SPS, Technical Information Center
3-20-1 Minami-Azabu, Minato-ku, Tokyo 106-8573, Japan
81-3-3440-3569

ASIA/PACIFIC: Motorola Semiconductors H.K. Ltd.; Silicon Harbour Centre
2 Dai King Street, Tai Po Industrial Estate, Tai Po, N.T., Hong Kong
852-26668334

HOME PAGE: <http://motorola.com/semiconductors>



MOTOROLA

**For More Information On This Product,
Go to: www.freescale.com**

MPC962308