

# HPI - 6FGR4

The HPI - 6FGR4 is a high - output, high - speed silicon photodiode mounted in a side - viewing plastic package with visible light cutoff filter. This photodiode is both compact and easy to mount.

**FEATURES**

- Compact visible ray widely cut off mold type
- High speed response

**APPLICATIONS**

- Optical transmission
- Optic receiver modules

**DIMENSIONS**

(Unit : mm)

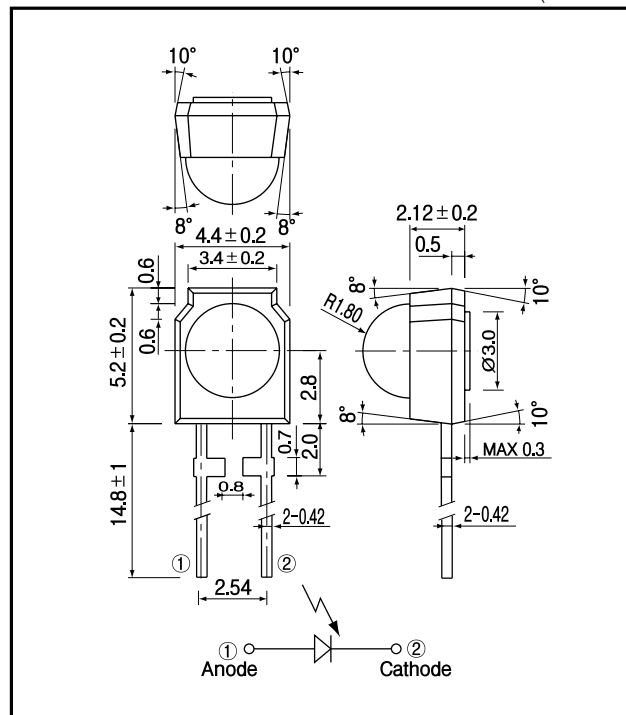

**MAXIMUM RATINGS**

(Ta=25 )

Item	Symbol	Rating	Unit
Reverse voltage	$V_R$	35	V
Power dissipation	$P_D$	150	mW
Operating temp.	$T_{opr.}$	- 30 + 70	
Storage temp.	$T_{stg.}$	- 40 + 80	
Soldering temp.*1	$T_{sol.}$	260	

\*1.For MAX.5 seconds at the position of 2 mm from the package

**ELECTRO-OPTICAL CHARACTERISTICS**

(Ta=25 )

Item	Symbol	Conditions	Min.	Typ.	Max.	Unit.
Open circuit voltage	$V_{oc}$	$E_v = 1,000lx^2$		0.38		V
Short circuit current	$I_{sc}$	$E_v = 1,000lx^2$		24		$\mu A$
Curve factor	C.F.		0.55			—
Dark current	$I_d$	$V_R = 10V$			10	nA
Capacitance	$C_t$	$V = 0V, f = 1MHz$		24		pF
Temperature coefficient of $V_{oc}$	t			- 2.2		mV/
Temperature coefficient of $I_{sc}$	t			0.18		%/
Spectral sensitivity				880 1050		nm
Peak wavelength	$\rho$			1,000		nm
Half angle				$\pm 40$		deg.

\*2.Color temp. =2856K standard Tungsten lamp

**PIN Photodiode**

**HPI - 6FGR4**

**Light current Vs. Forward voltage**

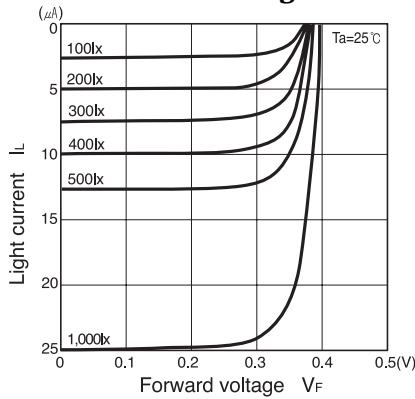

**Short circuit current Vs. Illuminance**

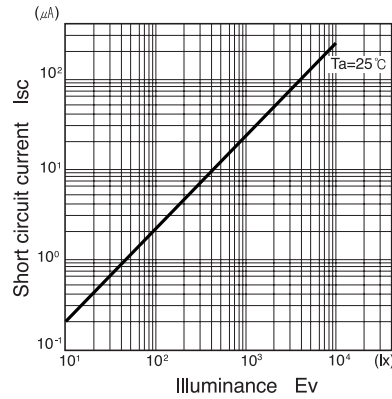

**Dark current Vs. Ambient temperature**

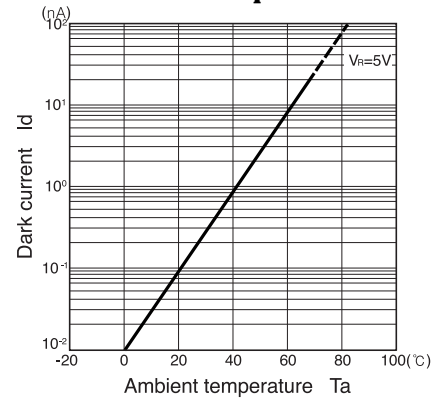

**Relative sensitivity Vs. Wavelength**

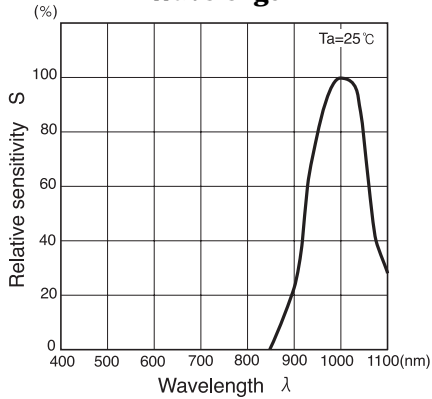

**Dark current Vs. Reverse voltage**

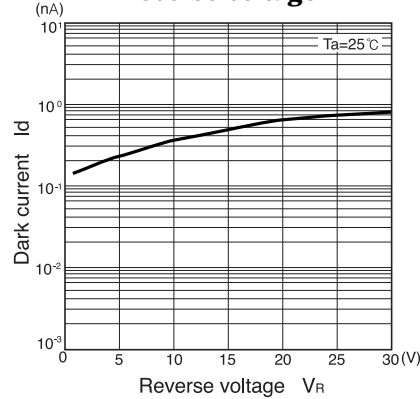

**Radiant Pattern**

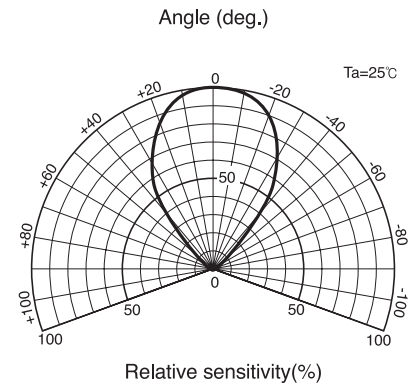

**Capacitance between terminals Vs. Reverse voltage**

