

LR38516

DESCRIPTION

The LR38516 is a CMOS timing generator IC which is designed for video-camcorders, and which generates timing pulses for driving 350 k-pixel progressive scan color CCD area sensors, synchronous pulses for TV signals and processing pulses for video signals.

FEATURES

- Designed for 350 k-pixel progressive scan color CCD area sensors
- Frame rate : 30 frame/s
- Shutter speed can be controlled in 1H period using a serial code
- TV mode selection, power mode selection and the phase selection of DCLK can be also controlled by using a serial code
- +3 V, +4.5 V and +5 V power supplies
- Package :
48-pin QFP (QFP048-P-0707) 0.5 mm pin-pitch

Timing Generator IC for 350 k-pixel Progressive Scan Color CCDs



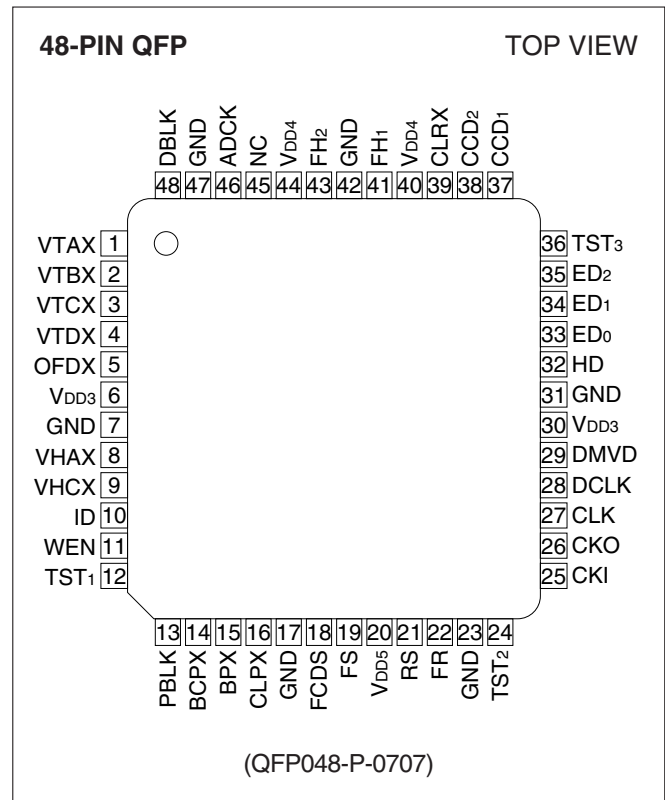



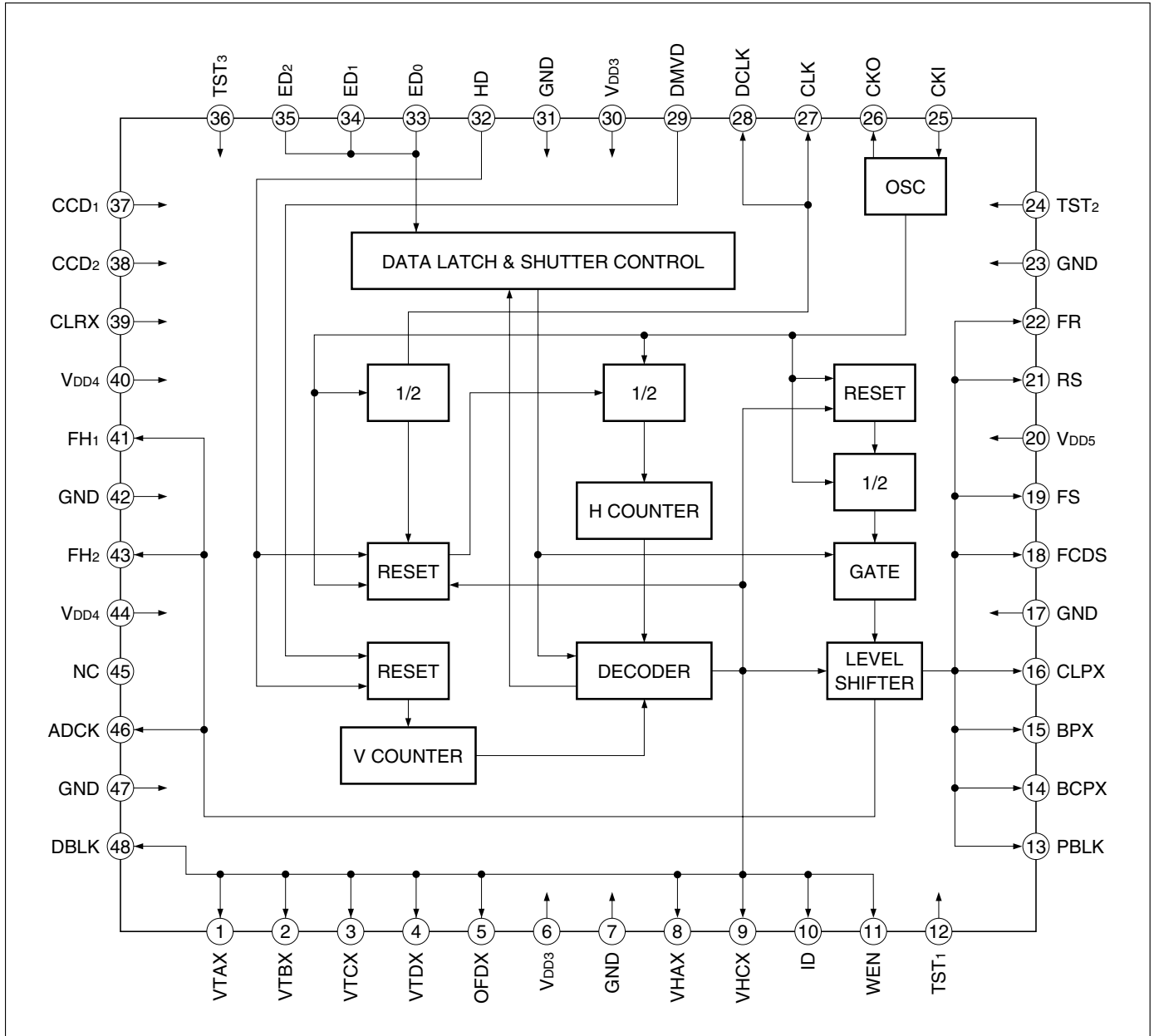



PIN CONNECTIONS











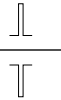
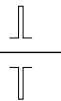
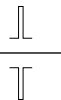

BLOCK DIAGRAM



PIN DESCRIPTION

PIN NO.	SYMBOL	I/O	POLARITY	PIN NAME	DESCRIPTION
1	VTAX	O3		Vertical transfer pulse output 1	A vertical transfer pulse for CCD. Connect to V1AX pin of the vertical driver IC. For details, see " CONNECTION OF VERTICAL TRANSFER PULSES ".
2	VTBX	O3		Vertical transfer pulse output 2	A vertical transfer pulse for CCD. Connect to V2AX pin of the vertical driver IC. For details, see " CONNECTION OF VERTICAL TRANSFER PULSES ".
3	VTCX	O3		Vertical transfer pulse output 3	A vertical transfer pulse for CCD. Connect to V3AX pin of the vertical driver IC. For details, see " CONNECTION OF VERTICAL TRANSFER PULSES ".
4	VTDX	O3		Vertical transfer pulse output 4	A vertical transfer pulse for CCD. Connect to V4AX pin of the vertical driver IC. For details, see " CONNECTION OF VERTICAL TRANSFER PULSES ".
5	OFDX	O3		OFD pulse output	A pulse that sweeps the charge of the photo-diode for the electronic shutter. Connect to OFD pin of CCD through the vertical driver IC and DC offset circuit. Held at H level at normal mode.
6	VDD3	–	–	Power supply	Supply of +3 V power.
7	GND	–	–	Ground	A grounding pin.
8	VHAX	O3		Readout pulse output 1	A pulse that transfers the charge of the photo-diode to the vertical shift register. For details, see " CONNECTION OF VERTICAL TRANSFER PULSES ".
9	VHCX	O3		Readout pulse output 3	A pulse that transfers the charge of the photo-diode to the vertical shift register. For details, see " CONNECTION OF VERTICAL TRANSFER PULSES ".
10	ID	O3		Line index pulse output	The pulse is used in color separator. The signal switches H and L at every line. H : R color line L : B color line
11	WEN	O3		Write enable output	Write enable output for low-speed shutter pulse.
12	TST ₁	ICD3	–	Test pin 1	A test pin. Set open or to L level in the normal mode.
13	PBLK	O5		Pre-blanking pulse output	A pulse that corresponds to the cease period of the horizontal transfer pulse.
14	BCPX	O5		Optical black clamp pulse output	A pulse to clamp the optical black signal. Output stays low during the absence of effective pixels within the vertical blanking.
15	BPX	O5		Clamp pulse output	A pulse to clamp the signal. The phase is same as BCPX (pin 14). This pulse is continuous at horizontal cycle.
16	CLPX	O5		Clamp pulse output	A pulse to clamp the dummy outputs of CCD. The pulse stays high during the sweep-out period.
17	GND	–	–	Ground	A grounding pin.

PIN NO.	SYMBOL	I/O	POLARITY	PIN NAME	DESCRIPTION
18	FCDS	O6MA5		CDS pulse output 1	A pulse to clamp the feed-through level from CCD. The polarity can be changed by serial data. The output phase of FCDS is selected by serial data.
19	FS	O6MA5		CDS pulse output 2	A pulse to sample-hold the signal from CCD. The polarity can be changed by serial data. The output phase of FS is selected by serial data.
20	VDD5	–	–	Power supply	Supply of +5 V power.
21	RS	O6MA5		S/H pulse output	A pulse to sample-hold the signal from CDS circuit. The polarity can be changed by serial data. The output phase of RS is selected by serial data.
22	FR	O6MA52		Reset pulse output	A pulse to reset the charge of output circuit. Connect to ϕ_R pin of CCD through the DC offset circuit. The output phase of FR is selected by serial data.
23	GND	–	–	Ground	A grounding pin.
24	TST ₂	ICD3	–	Test pin 2	A test pin. Set open or to L level in the normal mode.
25	CKI	OSCI3	–	Clock input	An input pin for reference clock oscillation. Connect to CKO (pin 26) with R. Frequency : 24.54545 MHz (1 560 fH) fH = Horizontal frequency
26	CKO	OSCO3	–	Clock output	An output pin for reference clock oscillation. The output is the inverse of CKI (pin 25).
27	CLK	O6MA3		Clock output	An output pin to generate HD and VD pulses. Connect to clock input pin of SSG IC. Frequency : 12.27273 MHz (780 fH)
28	DCLK	O6MA3		Clock output	An output pin for DSP IC. The output phase of DCLK is selected by serial data step by 90°. Frequency : 12.27273 MHz (780 fH)
29	DMVD	IC3		Vertical reference pulse input	An input pin for reference of vertical pulse. Connect to VD pin of DSP IC.
30	VDD3	–	–	Power supply	Supply of +3 V power.
31	GND	–	–	Ground	A grounding pin.
32	HD	IC3		Horizontal reference pulse input	An input pin for reference of horizontal pulse. Connect to HD pin of DSP IC.
33	ED ₀	IC3	–	Strobe pulse input	An input pin for the strobe pulse, to control the functions of LR38516. For details, see " Serial Data Control ".
34	ED ₁	IC3	–	Shift register clock input	An input pin for the clock of the shift register, to control the functions of LR38516. For details, see " Serial Data Control ".
35	ED ₂	IC3	–	Shift register data input	An input pin for the data of the shift register, to control the functions of LR38516. For details, see " Serial Data Control ".
36	TST ₃	ICD3	–	Test pin 3	A test pin. Set open or to L level in the normal mode.

PIN NO.	SYMBOL	I/O	POLARITY	PIN NAME	DESCRIPTION
37	CCD1	ICU4	–	CCD selection input 1	An input pin to select CCD. At CCD ₁ = H and CCD ₂ = H 1/4-type 350 k-pixel CCD (at NTSC)
38	CCD2	ICU4	–	CCD selection input 2	At CCD ₁ = H and CCD ₂ = L 1/3-type 350 k-pixel CCD (at NTSC)
39	CLR _X	ICU4	–	Data clear input	An input pin for resetting all serial data at power on. Connect V _{DD} through the diode and GND through the capacitor.
40	V _{DD4}	–	–	Power supply	Supply of +4.5 V power.
41	FH ₁	O6MA43		Horizontal transfer pulse output 1	A horizontal transfer pulse for CCD. Connect to ϕ_{H1} pin of CCD.
42	GND	–	–	Ground	A grounding pin.
43	FH ₂	O6MA43		Horizontal transfer pulse output 2	A horizontal transfer pulse for CCD. Connect to ϕ_{H2} pin of CCD.
44	V _{DD4}	–	–	Power supply	Supply of +4.5 V power.
45	NC	–	–	No connection	No connection.
46	ADCK	O6MA4		AD clock output	An output pin for A/D converter. The output phase of ADCK is selected by serial data step by 90°.
47	GND	–	–	Ground	A grounding pin.
48	DBLK	O3		Dummy composite output	Composite blanking pulse. Vertical : 33H period

IC3 : Input pin (CMOS level)

ICU4 : Input pin (CMOS level with pull-up resistor)

ICD3 : Input pin (CMOS level with pull-down resistor)

O3 : Output pin

O6MA3 : Output pin

O6MA4 : Output pin

O6MA43 : Output pin

O5 : Output pin

O6MA5 : Output pin

O6MA52 : Output pin

OSCI3 : Input pin for oscillation

OSCO3 : Output pin for oscillation

CONNECTION OF VERTICAL TRANSFER PULSES

OUTPUT PULSE	LEVEL SHIFT, INVERT, MIX	1/4-TYPE 350 k	1/3-TYPE 350 k, 380 k AND 450 k
VTAX	3-level pulse with V driver	ϕ_{V3B}	ϕ_{V1}
VHAX			
VTCX	3-level pulse with V driver	ϕ_{V3A}	ϕ_{V3}
VHCX			
VTBX	2-level pulse with V driver	ϕ_{V2}	ϕ_{V2}
VTDX	2-level pulse with V driver	ϕ_{V1}	ϕ_{V4}

Serial Data Control

SERIAL DATA INPUT TIMING

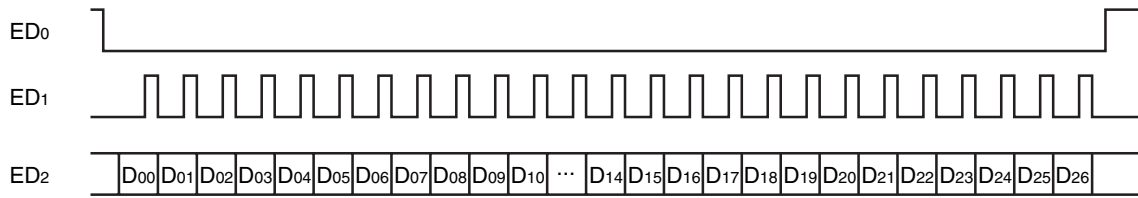

The data on ED2 is latched in the register at the rising edge of ED1.

The data of D13 is effective. Other data are effective at next horizontal line of readout horizontal

line while VHAX and VHCX are active.

ED0 has to be kept L level in effective data input period.

SERIAL DATA INPUTS

DATA	NAME	FUNCTION	DATA = L	DATA = H	AT CLRX = L
D00-D09	SD0-SD9	Electronic shutter speed control	-		All L
D10	SMD0	Electronic shutter mode control	-		L
D11	SMD1		-		L
D12	TVMD	TV mode selection	NTSC	-	L
D13	PWSA	Power save control	Normal	Power save	-
D14	ML1	Phase control	-		L
D15	ML2		-		L
D16	MA1		-		L
D17	MA2		-		L
D18	PLCH	Polarity control of FCDS, FS and RS pulses	Negative	Positive	L
D19	MR1	Phase control	-		L
D20	MR2		-		L
D21	MC1		-		L
D22	MC2		-		L
D23	MS1		-		L
D24	MS2		-		L
D25	MF1		-		L
D26	MF2		-		L

ABSOLUTE MAXIMUM RATINGS

PARAMETER	SYMBOL	RATING	UNIT
Supply voltage	VDD3, VDD4, VDD5	-0.3 to +6.0	V
Input voltage	VI3	-0.3 to VDD3 + 0.3	V
	VI4	-0.3 to VDD4 + 0.3	V
Output voltage	VO3	-0.3 to VDD3 + 0.3	V
	VO4	-0.3 to VDD4 + 0.3	V
	VO5	-0.3 to VDD5 + 0.3	V
Operating temperature	TOPR	-20 to +70	°C
Storage temperature	TSTG	-55 to +150	°C

ELECTRICAL CHARACTERISTICS

DC Characteristics (VDD3 = 3.0±0.3 V, VDD4 = 4.5±0.45 V, VDD5 = 5.0±0.5 V, TOPR = -20 to +70 °C)

PARAMETER	SYMBOL	CONDITIONS	MIN.	TYP.	MAX.	UNIT	NOTE
Input "Low" voltage	VIL3				0.2VDD3	V	1, 2
Input "High" voltage	VIH3		0.8VDD3			V	
Input "Low" voltage	VIL4				0.2VDD4	V	3
Input "High" voltage	VIH4		0.8VDD4			V	
Input "Low" current	IIL3-1	VI = 0 V			1.0	µA	1
Input "High" current	IIH3-1	VI = VDD3			1.0	µA	
Input "Low" current	IIL3-2	VI = 0 V			1.0	µA	2
Input "High" current	IIH3-2	VI = VDD3	2.0		30	µA	
Input "Low" current	IIL4	VI = 0 V	4.0		60	µA	3
Input "High" current	IIH4	VI = VDD4			2.0	µA	
Output "Low" voltage	VOL3-1	IOL = 2 mA			0.4	V	4
Output "High" voltage	VOH3-1	IOH = -2 mA	VDD3 - 0.5			V	
Output "Low" voltage	VOL3-2	IOL = 2 mA			0.4	V	5
Output "High" voltage	VOH3-2	IOH = -1 mA	VDD3 - 0.5			V	
Output "Low" voltage	VOL3-3	IOL = 3 mA			0.4	V	6
Output "High" voltage	VOH3-3	IOH = -3 mA	VDD3 - 0.5			V	
Output "Low" voltage	VOL4-1	IOL = 4 mA			0.4	V	7
Output "High" voltage	VOH4-1	IOH = -4 mA	VDD4 - 0.5			V	
Output "Low" voltage	VOL4-2	IOL = 12 mA			0.4	V	8
Output "High" voltage	VOH4-2	IOH = -12 mA	VDD4 - 0.5			V	
Output "Low" voltage	VOL5-1	IOL = 4 mA			0.4	V	9
Output "High" voltage	VOH5-1	IOH = -2 mA	VDD5 - 0.5			V	
Output "Low" voltage	VOL5-2	IOL = 6 mA			0.4	V	10
Output "High" voltage	VOH5-2	IOH = -6 mA	VDD5 - 0.5			V	
Output "Low" voltage	VOL5-3	IOL = 12 mA			0.4	V	11
Output "High" voltage	VOH5-3	IOH = -12 mA	VDD5 - 0.5			V	

NOTES :

- Applied to inputs (IC3, OSCI3).
- Applied to input (ICD3).
- Applied to input (ICU4).
- Applied to output (OSCO3). (Output (OSCO3) measures on condition that input (OSCI3) level is 0 V or VDD3.)
- Applied to output (O3).
- Applied to output (O6MA3).
- Applied to output (O6MA4).
- Applied to output (O6MA43).
- Applied to output (O5).
- Applied to output (O6MA5).
- Applied to output (O6MA52).

PACKAGE

(Unit : mm)

48 QFP (QFP048-P-0707)

