



FEATURES

- Handles from signal level to 5 amps
- 1 Form A contact form
- Ultra Slim, 5 MM package
- SIL terminal pattern
- Terminals on 1/10 in grid pattern
- 2 Kv dielectric between coil and contacts
- Sealed, immersion cleanable



File # E86876

UL/CSA RATINGS

Load Type	All Forms All Contacts
General Use	3A or 5A at 30VDC / 250VAC
Resistive	3A or 5A at 30VDC / 250VAC
Minimum Load	0.1 mA @ 0.1 VDC

CONTACT DATA

Material		AgCdO (Silver Cadmium Oxide) AgCdO+Au (Silver Cad Oxide Gold Clad)
Initial Contact Resistance		100 milliohms max @ 0.1A, 6VDC
Service Life	Mechanical	2 X 10 ⁷ Operations
	Electrical	1 X 10 ⁵ Operations

CHARACTERISTICS

Operate Time	6 ms. Max.
Release Time	3 ms. Max.
Insulation Resistance	1000 megohms min, at 500VDC, 50%RH
Dielectric Strength	2000 Vrms, 1 min. between coil and contacts 1000 Vrms, 1 min. between open contacts
Shock Resistance	10 g, 11ms, functional; 100 g, destructive
Vibration Resistance	DA 2.5 mm, 10 - 55 Hz
Power Consumption	.12W
Ambient Temperature Range	-40 to 70 C operating for class B, -40 to 130 C storage
Weight	3 grams approx.

ORDERING INFORMATION

Example:	PC458	-1A	-12	S	-5
Model					
Contact Form					
1A					
Coil Voltage					
Enclosure					
S: Sealed; C: Flux Free					
Contact Rating					
3: 3 AMP; 5: 5 AMP					

COIL DATA

Coil Voltage	Resistance ohms $\pm 10\%$	Must Operate Voltage Max. (VDC)	Must Release Voltage Min. (VDC)	Continuous Voltage Max. (VDC)
3	75	2.2	0.15	3.3
5	208	3.5	0.25	5.5
6	300	4.2	0.30	6.6
9	675	6.3	0.45	9.9
12	1200	8.4	0.60	13.2
18	2700	12.6	0.90	19.8
24	3200	16.8	1.20	26.4

Note: Custom coil voltages within the ranges shown are available on special order.

**Dimensions in Inches (millimeters)
Drawings are 2X actual size**

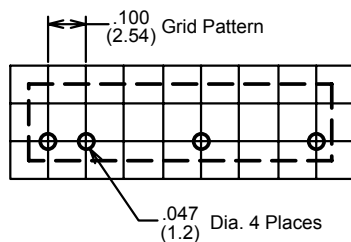
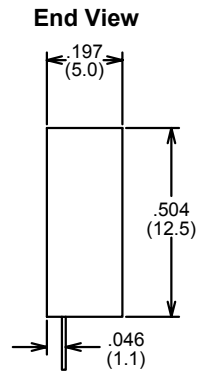
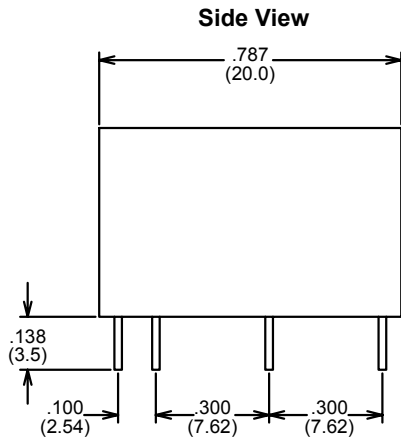

Hole Pattern



Wiring Diagram

Notes:

Tolerances $\pm .010$ unless otherwise noted
Relays previously tested or used above 10mA at 6VDC or higher
are not recommended for subsequent use in low level applications



3220 Commander Drive, Suite 102, Carrollton, Texas 75006

Sales: Call Toll Free (888) 997-3933 Fax (818) 342-5296 email: pickerwest@sbcglobal.net URL: pickercomponents.com