



**TELEDYNE
RELAYS**

A Teledyne Technologies Company

**SURFACE MOUNT
MAGNETIC-LATCHING
TO-5 RELAYS
DPDT**



**SERIES
S422**



SERIES DESIGNATION	RELAY TYPE
S422	DPDT Surface Mount Basic Relay
S422D	DPDT Surface Mount Relay with internal diode for coil transient suppression
S422DD	DPDT Surface Mount Relay with internal diode for coil transient suppression and polarity reversal protection

DESCRIPTION

The magnetic-latching TO-5 relay, originally conceived and developed by Teledyne, has become one of the industry standards for low-level switching from dry circuit to 1 ampere. Designed for high-density PC board surface mounting, its small size and low coil power dissipation make the S422 relay one of the most versatile ultraminiature relays available.

The following unique construction features and manufacturing techniques provide excellent resistance to environmental extremes and overall high reliability:

- All welded construction.
- Unique uni-frame design providing high magnetic efficiency and mechanical rigidity.
- High force/mass ratios for resistance to shock and vibration.
- Advanced cleaning techniques provide maximum assurance of internal cleanliness.
- Precious metal alloy contact material with gold plating assures excellent high current and dry circuit switching capabilities.

The Series S422D and S422DD utilize discrete diodes for coil suppression and polarity reversal protection.

By virtue of its inherently low intercontact capacitance and contact circuit losses, these TO-5 relays have proven to be excellent ultra-miniature RF switches for frequency ranges well into the UHF spectrum. A typical RF application for these TO-5 relays is in handheld radio receivers, wherein the combined features of good RF performance, small size, very low coil power dissipation and high reliability make it a preferred method of transmit-receive switching (See Figure 1).

The Series S422 magnetic-latching relays are ideally suited for applications where power dissipation must be minimized. The relays can be operated with a short duration pulse. After the contacts have transferred, no external holding power is required.

The magnetic latching feature of the Series S422 relays provide a "memory" capability, since the relays will not reset upon removal of coil power.

PRINCIPAL OF OPERATION

Energizing Coil B produces a magnetic field opposing the holding flux of the permanent magnet in Circuit B. As this net holding force decreases, the attractive force in the air gap of Circuit A, which also results from the flux of the permanent magnet, becomes great enough to break the armature free of Core B, and snap it into a closed position against Core A. The armature then remains in this position upon removal of power from Coil B, but will snap back into position B upon energizing Coil A. Since operation depends upon cancellation of a magnetic field, it is necessary to apply the correct polarity to the relay coils as indicated on the relay schematic. When latching relays are installed in equipment, the latch and reset coils should not be pulsed simultaneously. Coils should not be pulsed with less than rated coil voltage and the pulse width should be a minimum of three times the specified operate time of the relay. If these conditions are not followed, it is possible for the relay to be in the magnetic neutral position.

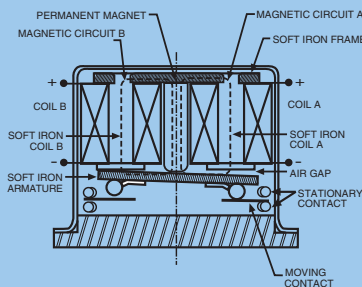

**ENVIRONMENTAL AND
PHYSICAL SPECIFICATIONS**

Temperature (Ambient)	-65°C to +125°C
Vibration (General Note 1)	30 g's to 3000 Hz
Shock (General Note 1)	100 g's, 6msec, half sine
Acceleration	50 g's
Enclosure	Hermetically sealed
Weight	0.10 oz. (2.84g) max.

SERIES S422

GENERAL ELECTRICAL SPECIFICATIONS (-65 °C to +125 °C unless otherwise noted)(Notes 2 & 3)

Contact Arrangement	2 Form C (DPDT)	
Rated Duty	Continuous	
Contact Resistance	0.125 Ω max. before life; 0.225 Ω max. after life at 1.0 A/28Vdc (measured 1/8" from header)	
Contact Load Rating (DC) (See Fig. 2 for other DC resistive voltage/current ratings)	Resistive: 1Amp/28Vdc Inductive: 200 mA/28Vdc (320 mH) Lamp: 100 mA/28Vdc Low level: 10 to 50 μA, 10 to 50 mV	
Contact Load Rating (AC)	Resistive: 250 mA/115Vac, 60 Hz and 400 Hz (Case not grounded) 100 mA/115Vac, 60 Hz and 400 Hz (Case grounded)	
Contact Life Ratings	10,000,000 cycles (typical) at low level 1,000,000 cycles (typical) at 0.5 A/28Vdc resistive 100,000 cycles min. at all other loads specified above	
Contact Overload Rating	2A/28Vdc Resistive (100 cycles min.)	
Contact Carry Rating	Contact Factory	
Coil Operating Power	290 mW typical @ nominal rated voltage @ 25 °C	
Operate Time	S422/S422D: 1.5 mS max. at nominal rated coil voltage S422DD: 2.0 mS max. at nominal rated coil voltage	
Contact Bounce	2.0 msec max.	
Minimum Operate Pulse	4.5 mS width @ rated voltage	
Intercontact Capacitance	0.4 pF typical	
Insulation Resistance	10,000 MΩ min. between mutually isolated terminals	
Dielectric Strength	500 Vrms (60 Hz) @ atmospheric pressure;	70,000 ft.: 125 Vrms/60 Hz
Negative Coil Transient (Vdc)	S422D, S422DD	1.0 max
Diode P.I.V. (Vdc)	S422D, S422DD	100 min.

DETAILED ELECTRICAL SPECIFICATIONS (-65 °C to +125 °C unless otherwise noted) (Note 3)

BASE PART NUMBERS (See Note 10 for P/N example)		S422-5 S422D-5 S422DD-5	S422-6 S422D-6 S422DD-6	S422-9 S422D-9 S422DD-9	S422-12 S422D-12 S422DD-12	S422-18 S422D-18 S422DD-18	S422-26 S422D-26 S422DD-26
Coil Voltage, Nominal (Vdc)	Nom.	5.0	6.0	9.0	12.0	18.0	26.5
	Max.	6.0	8.0	12.0	16.0	24.0	32.0
Coil Resistance (Ohms ±10% @ 25 °C)	S422 S422D	61	120	280	500	1130	2000
	S422DD (Note 4)	48	97	280	500	1130	2000
Coil Current (mA_{dc} @ 25 °C) (S422DD Series only)	Min.	75.8	46.9	26.0	20.0	13.7	11.6
	Max.	104.2	63.0	33.7	25.5	17.2	14.4
Set & Reset Voltage (Vdc, Max.)	S422 S422D	3.5	4.5	6.8	9.0	13.5	18.0
	S422DD	4.5	5.5	7.8	10.0	14.5	19.0

PERFORMANCE CURVES (NOTE 2)

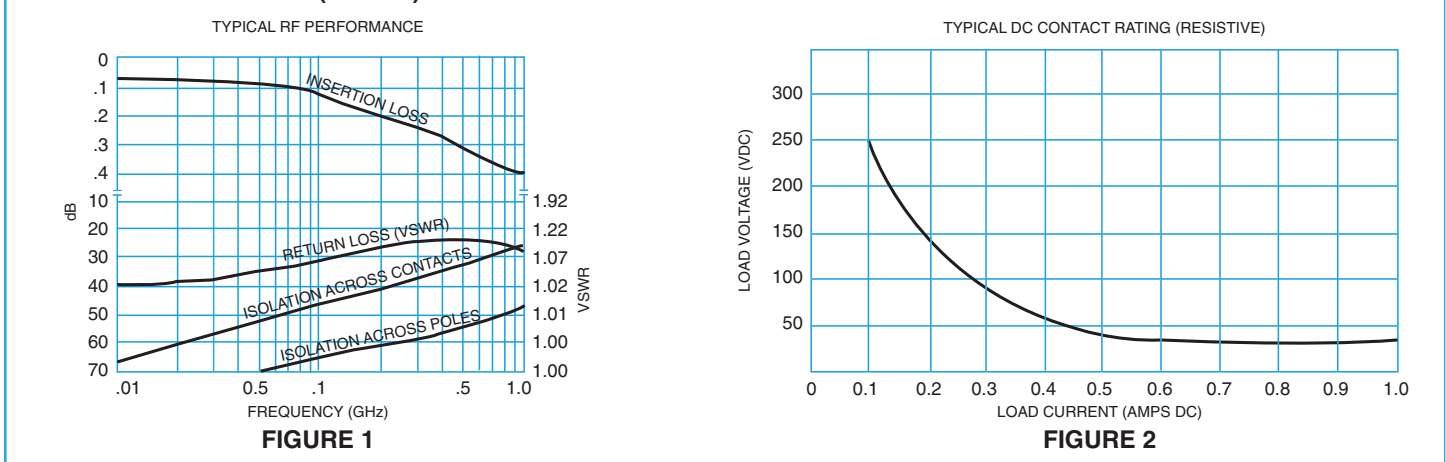

**SERIES S422
OUTLINE DIMENSIONS**

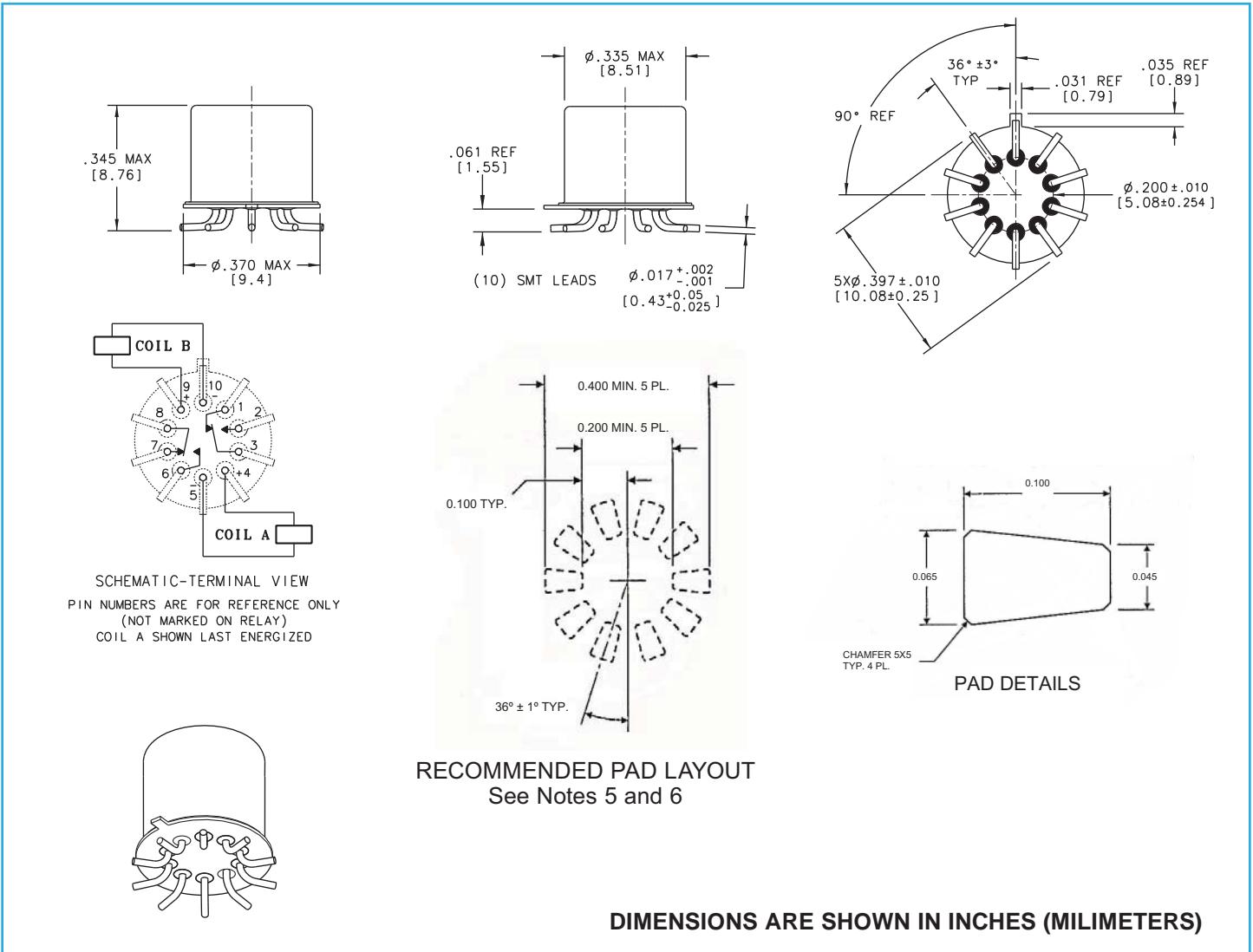

GENERAL NOTES

1. Relay contacts will exhibit no chatter in excess of 10 μ sec or transfer in excess of 1 μ sec.
2. "Typical" characteristics are based on available data and are best estimates. No on-going verification tests are performed.
3. Unless otherwise specified, parameters are initial values.
4. For reference only. Coil resistance not directly measurable at relay terminals due to internal series diode. S422DD only.
5. Recommended solder paste thickness: 0.01"
6. Leads will fit pad layout shown with no overhang.
7. Unless otherwise specified, relays will be supplied with solder-coated leads.
8. The slash and characters appearing after the slash are not marked on the relay.
9. Screened HI-REL versions available. Contact Factory.
- 10.

Teledyne Part Numbering System for Standard TO-5 and Centigrad Surface Mount Relays

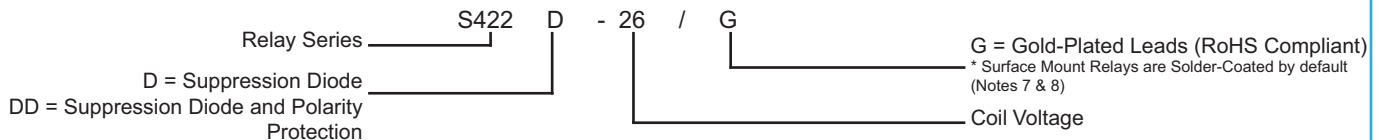

11. Add "/R" to end of part number for RoHS compliant solder coated pins (Sn99.3/Cu0.7).

Appendix A: Spacer Pads

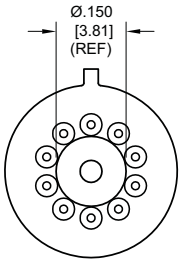
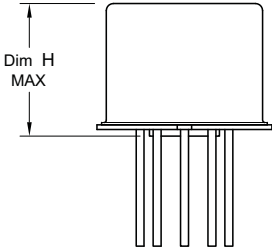
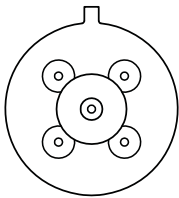
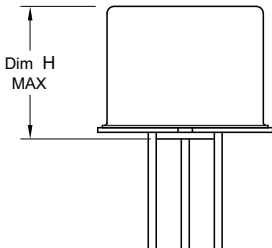
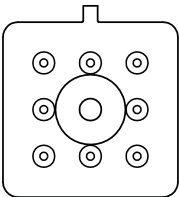
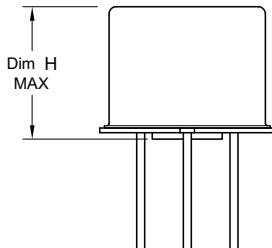
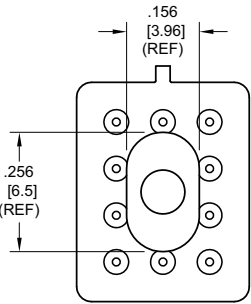
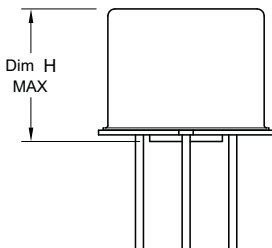
Pad designation and bottom view dimensions	Height	For use with the following:	Dim. H Max.
 <p style="text-align: center;">“M4” Pad for TO-5</p>		ER411T ER412, ER412D, ER412DD	.295 (7.49)
		712, 712D, 712TN, RF300, RF310, RF320	.300 (7.62)
		ER420, ER422D, ER420DD, 421, ER421D, ER421DD, ER422, ER422D, ER422DD, 722, 722D, RF341	.305 (7.75)
		ER431T, ER432T, ER432, ER432D, ER432DD	.400 (10.16)
		732, 732D, 732TN, RF303, RF313, RF323	.410 (10.41)
		RF312	.350 (8.89)
 <p style="text-align: center;">“M4” Pad for TO-5</p>		ER411, ER411D, ER411DD	.295 (7.49)
		ER431, ER431D, ER431DD	.400 (10.16)
		RF311	.300 (7.62)
		RF331	.410 (10.41)
 <p style="text-align: center;">“M4” Pad for Centigrid®</p>		172, 172D	.305 (7.75)
		ER114, ER114D, ER114DD, J114, J114D, J114DD	.300 (7.62)
		ER134, ER134D, ER134DD, J134, J134D, J134DD	.400 (10.16)
		RF100	.315 (8.00)
		RF103	.420 (10.67)
 <p style="text-align: center;">“M9” Pad for Centigrid®</p>		122C, A152	.320 (8.13)
		ER116C, J116C	.300 (7.62)
		ER136C, J136C	.400 (10.16)
		RF180	.325 (8.25)
		A150	.305 (7.75)

Notes:

1. Spacer pad material: Polyester film.
2. To specify an “M4” or “M9” spacer pad, refer to the mounting variants portion of the part numbering example in the applicable datasheet.
3. Dimensions are in inches (mm).
4. Unless otherwise specified, tolerance is $\pm .010$ (.25).
5. Add 10 m Ω to the contact resistance shown in the datasheet.
6. Add 0.01 oz. (0.25 g) to the weight of the relay assembly shown in the datasheet.

Appendix A: Spreader Pads

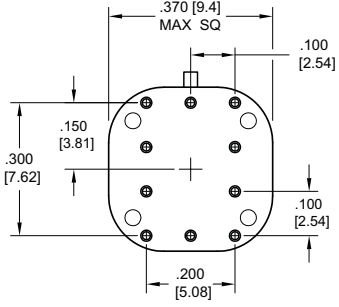
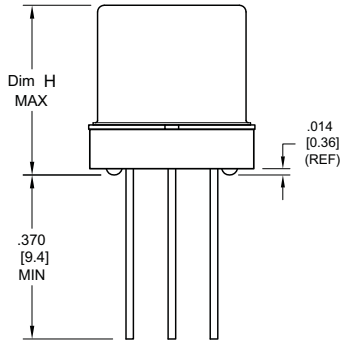
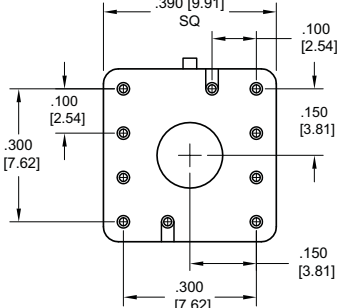
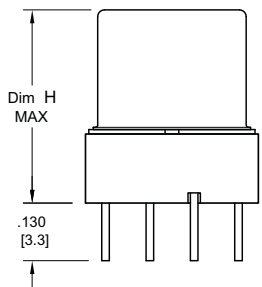
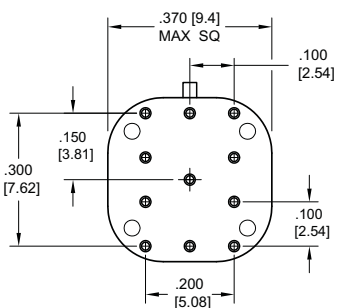
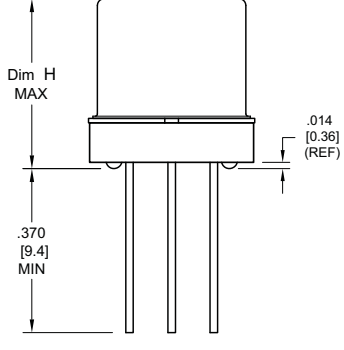
Pad designation and bottom view dimensions	Height	For use with the following:	Dim. H Max.
 <p>"M" Pad <u>5/ 6/</u></p>		ER411T, J411T, ER412, ER412D ER412DD, J412, J412D, J412DD ER412T, J412T	.388 (9.86)
		712, 712D, 712TN	.393 (9.99)
		ER431T, J431T, ER432, ER432D ER432DD, J432, J432D, J432DD ER432T, J432T	.493 (12.52)
		732, 732D, 732TN	.503 (12.78)
		ER420, J420, ER420D, J420D ER420DD, J420DD, ER421, J421 ER421D, J421D, ER421DD J422D, ER422DD, J422DD, 722	.398 (10.11)
 <p>"M2" Pad <u>7/ 8/</u></p>		ER411T ER412, ER412D, ER412DD J412, J412D, J412DD	.441 (11.20)
		712, 712D	.451 (11.46)
		ER421, ER421D, ER421DD 722, 732D	.451 (11.46)
		ER431T ER432, ER432D, ER432DD	.546 (13.87)
		732, 732D	.556 (14.12)
 <p>"M3" Pad <u>5/ 6/ 9/</u></p>		ER411, ER411D, ER411DD ER411TX ER412X, ER412DX, ER412DDX ER412TX	.388 (9.86)
		712X, 712DX, 712TNX	.393 (9.99)
		ER420X, ER420DX, ER420DDX ER421X, ER421DX, ER421DDX ER422X, ER422DX ER422DDX, 722X, 722DDX	.398 (10.11)
		ER431, ER431D, ER431DD ER431TX ER432X, ER432DX, ER432DDX ER432TX	.493 (12.52)
		732X, 732DX, 732TNX	.503 (12.78)

Notes:

1. Spreader pad material: Diallyl Phthalate.
2. To specify an "M", "M2" or "M3" spreader pad, refer to the mounting variants portion of the part number example in the applicable datasheet.
3. Dimensions are in inches (mm).
4. Unless otherwise specified, tolerance is $\pm .010$ " (0.25).
- 5/. Add 25 m Ω to the contact resistance shown in the datasheet.
- 6/. Add .01 oz. (0.25 g) to the weight of the relay assembly shown in the datasheet.
- 7/. Add 50 m Ω to the contact resistance shown in the datasheet.
- 8/. Add 0.025 oz (0.71 g) to the weight of the relay assembly shown in the datasheet.
- 9/. M3 pad to be used only when the relay has a center pin (e.g. ER411M3-12A, 722XM3-26.)

Appendix A: Ground Pin Positions

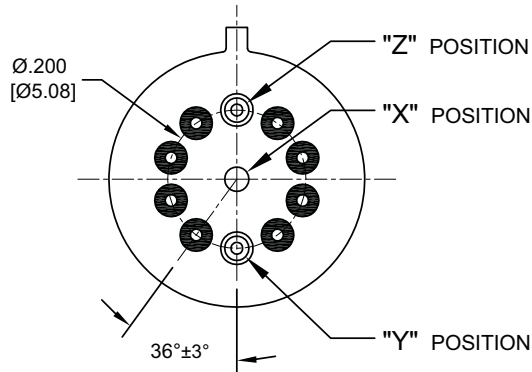

TO-5 Relays:

ER411T, ER412, ER412T, ER420, ER421, ER422,
ER431T, ER432, ER432T, 712, 712TN, 400H, 400K,
400V, RF300, RF303, RF341, RF312, RF310, RF313,
RF320, RF323

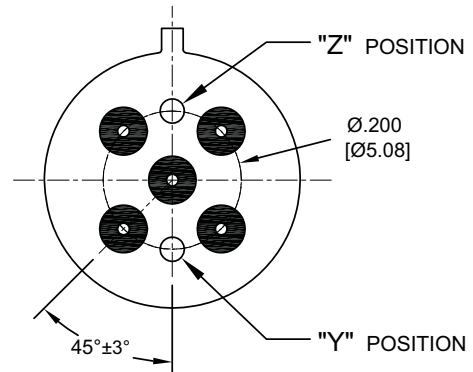

TO-5 Relays:

ER411, ER431, RF311, RF331

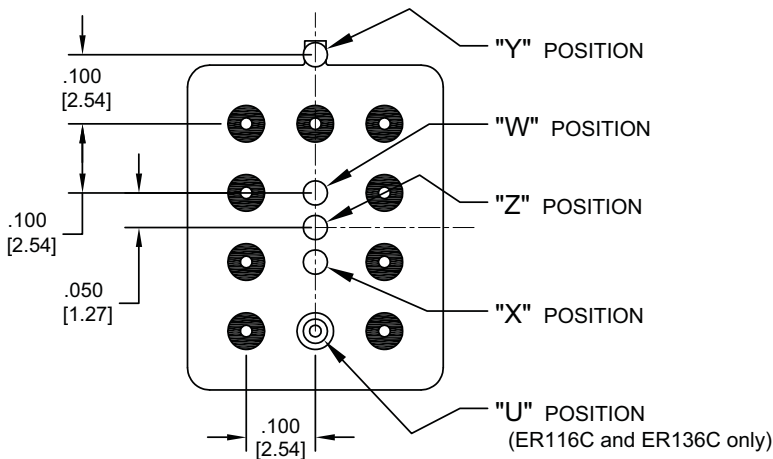

Centigrad® Relays:

RF180, ER116C, 122C, ER136C

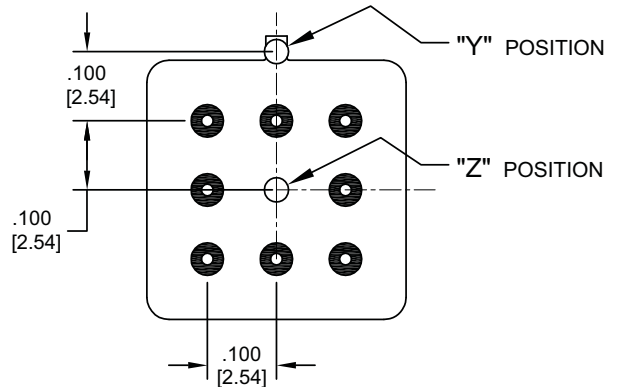

Centigrad® Relays:

RF100, RF103, ER114, ER134, 172

- Indicates ground pin position
- Indicates glass insulated lead position
- ⊙ Indicates ground pin or lead position depending on relay type

NOTES

1. Terminal views shown
2. Dimensions are in inches (mm)
3. Tolerances: $\pm .010$ ($\pm .25$) unless otherwise specified
4. Ground pin positions are within $.015$ (0.38) dia. of true position
5. Ground pin head dia., 0.035 (0.89) ref: height 0.010 (0.25) ref.
6. Lead dia. 0.017 (0.43) nom.