

5 V, SILICON GERMANIUM MMIC MEDIUM OUTPUT POWER AMPLIFIER

DESCRIPTION

The μPC3236TK is a silicon germanium carbon (SiGe:C) monolithic integrated circuit designed as IF amplifier for DBS LNB.

This device exhibits low noise figure and high power gain characteristics.

This IC is manufactured using our UHS4 (Ultra High Speed Process) SiGe:C bipolar process.

FEATURES

- Low current : $I_{CC} = 24.0$ mA TYP.
- Medium output power : $P_{O(sat)} = +15.5$ dBm TYP. @ $f = 1.0$ GHz
: $P_{O(sat)} = +10.5$ dBm TYP. @ $f = 2.2$ GHz
- High linearity : $P_{O(1dB)} = +11$ dBm TYP. @ $f = 1.0$ GHz
: $P_{O(1dB)} = +7.5$ dBm TYP. @ $f = 2.2$ GHz
- Power gain : $G_P = 38$ dB TYP. @ $f = 1.0$ GHz
: $G_P = 38$ dB TYP. @ $f = 2.2$ GHz
- Gain flatness : $\Delta G_P = 1.0$ dB TYP. @ $f = 1.0$ to 2.2 GHz
- Noise Figure : $NF = 2.6$ dB TYP. @ $f = 1.0$ GHz
: $NF = 2.6$ dB TYP. @ $f = 2.2$ GHz
- Supply voltage : $V_{CC} = 4.5$ to 5.5 V
- Port impedance : input/output 50Ω

APPLICATIONS

- IF amplifiers in DBS LNB, other L-band amplifiers, etc.

ORDERING INFORMATION

Part Number	Order Number	Package	Marking	Supplying Form
μPC3236TK-E2	μPC3236TK-E2-A	6-pin lead-less minimold (1511 PKG) (Pb-Free)	6U	<ul style="list-style-type: none"> • Embossed tape 8 mm wide • Pin 1, 6 face the perforation side of the tape • Qty 5 kpcs/reel

Remark To order evaluation samples, please contact your nearby sales office
Part number for sample order: μPC3236TK

Caution Observe precautions when handling because these devices are sensitive to electrostatic discharge.

The information in this document is subject to change without notice. Before using this document, please confirm that this is the latest version.
Not all products and/or types are available in every country. Please check with an NEC Electronics sales representative for availability and additional information.

PIN CONNECTIONS AND INTERNAL BLOCK DIAGRAM

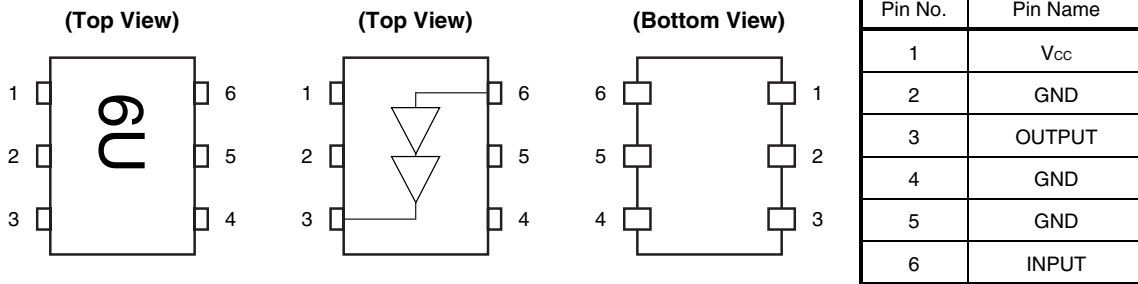

PRODUCT LINE-UP OF 5 V-BIAS SILICON MMIC MEDIUM OUTPUT POWER AMPLIFIER
(T_A = +25°C, f = 1 GHz, V_{CC} = V_{out} = 5.0 V, Z_s = Z_L = 50 Ω)

Part No.	I _{CC} (mA)	G _P (dB)	NF (dB)	P _O (1dB) (dBm)	P _O (sat) (dBm)	Package	Marking
μPC2708TB	26	15.0	6.5	-	+10.0	6-pin super minimold	C1D
μPC2709TB	25	23.0	5.0	-	+11.5		C1E
μPC2710TB	22	33.0	3.5	-	+13.5		C1F
μPC2776TB	25	23.0	6.0	-	+8.5		C2L
μPC3223TB	19	23.0	4.5	+6.5	+12.0		C3J
μPC3225TB	24.5	32.5 ^{Note}	3.7 ^{Note}	+9 ^{Note}	+15.5 ^{Note}		C3M
μPC3226TB	15.5	25.0	5.3	+7.5	+13.0		C3N
μPC3232TB	26	32.8	4.0	+11	+15.5		C3S
μPC3236TK	24	38	2.6	+11	+15.5	6-pin lead-less minimold (1511 PKG)	6U

Note μPC3225TB is f = 0.95 GHz

Remark Typical performance. Please refer to **ELECTRICAL CHARACTERISTICS** in detail.

ABSOLUTE MAXIMUM RATINGS

Parameter	Symbol	Conditions	Ratings	Unit
Supply Voltage	V _{CC}	T _A = +25°C, pin 1 and 3	6.0	V
Power Dissipation	P _D	T _A = +85°C Note	232	mW
Operating Ambient Temperature	T _A		-40 to +85	°C
Storage Temperature	T _{stg}		-55 to +150	°C
Input Power	P _{in}	T _A = +25°C	0	dBm

Note Mounted on double-sided copper-clad 50 × 50 × 1.6 mm epoxy glass PWB

RECOMMENDED OPERATING RANGE

Parameter	Symbol	Conditions	MIN.	TYP.	MAX.	Unit
Supply Voltage	V _{CC}	The same voltage should be applied to pin 1 and 3.	4.5	5.0	5.5	V
Operating Ambient Temperature	T _A		-40	+25	+85	°C

ELECTRICAL CHARACTERISTICS (T_A = +25°C, V_{CC} = V_{out} = 5.0 V, Z_s = Z_L = 50 Ω)

Parameter	Symbol	Test Conditions	MIN.	TYP.	MAX.	Unit
Circuit Current	I _{CC}	No input signal	19	24	31	mA
Power Gain 1	G _{P1}	f = 0.25 GHz, P _{in} = -40 dBm	34	37	39	dB
Power Gain 2	G _{P2}	f = 1.0 GHz, P _{in} = -40 dBm	35.5	38	40.5	
Power Gain 3	G _{P3}	f = 1.8 GHz, P _{in} = -40 dBm	36	39	42	
Power Gain 4	G _{P4}	f = 2.2 GHz, P _{in} = -40 dBm	35	38	41	
Saturated Output Power 1	P _{O(sat)1}	f = 1.0 GHz, P _{in} = 0 dBm	+13.5	+15.5	-	dBm
Saturated Output Power 2	P _{O(sat)2}	f = 2.2 GHz, P _{in} = -5 dBm	+8.5	+10.5	-	
Gain 1 dB Compression Output Power 1	P _{O(1dB)1}	f = 1.0 GHz	+8	+11	-	dBm
Gain 1 dB Compression Output Power 2	P _{O(1dB)2}	f = 2.2 GHz	+5	+7.5	-	
Noise Figure 1	NF1	f = 1.0 GHz	-	2.6	3.5	dB
Noise Figure 2	NF2	f = 2.2 GHz	-	2.6	3.5	
Isolation 1	ISL1	f = 1.0 GHz, P _{in} = -40 dBm	43	50	-	dB
Isolation 2	ISL2	f = 2.2 GHz, P _{in} = -40 dBm	43	50	-	
Input Return Loss 1	RL _{in1}	f = 1.0 GHz, P _{in} = -40 dBm	6	9	-	dB
Input Return Loss 2	RL _{in2}	f = 2.2 GHz, P _{in} = -40 dBm	6.5	9.5	-	
Output Return Loss 1	RL _{out1}	f = 1.0 GHz, P _{in} = -40 dBm	8	11	-	dB
Output Return Loss 2	RL _{out2}	f = 2.2 GHz, P _{in} = -40 dBm	7	10	-	

STANDARD CHARACTERISTICS FOR REFERENCE

(T_A = +25°C, V_{CC} = V_{out} = 5.0 V, Z_s = Z_L = 50 Ω, unless otherwise specified)

Parameter	Symbol	Test Conditions	Reference Value	Unit
Power Gain 5	G _{P5}	f = 2.6 GHz, P _{in} = -40 dBm	36	dB
Power Gain 6	G _{P6}	f = 3.0 GHz, P _{in} = -40 dBm	32.5	
Gain Flatness	ΔG _P	f = 1.0 to 2.2 GHz, P _{in} = -40 dBm	1.0	dB
K factor 1	K1	f = 1.0 GHz, P _{in} = -40 dBm	1.6	-
K factor 2	K2	f = 2.2 GHz, P _{in} = -40 dBm	1.6	-
Output 3rd Order Intercept Point 1	OIP ₃₁	f ₁ = 1 000 MHz, f ₂ = 1 001 MHz	23	dBm
Output 3rd Order Intercept Point 2	OIP ₃₂	f ₁ = 2 200 MHz, f ₂ = 2 201 MHz	16.5	
2nd Order Intermodulation Distortion	IM ₂	f ₁ = 1 000 MHz, f ₂ = 1 001 MHz, P _{out} = -5 dBm/tone	45	dBc
2nd Harmonic	2f ₀	f ₀ = 1.0 GHz, P _{out} = -15 dBm	58	dBc

TEST CIRCUIT

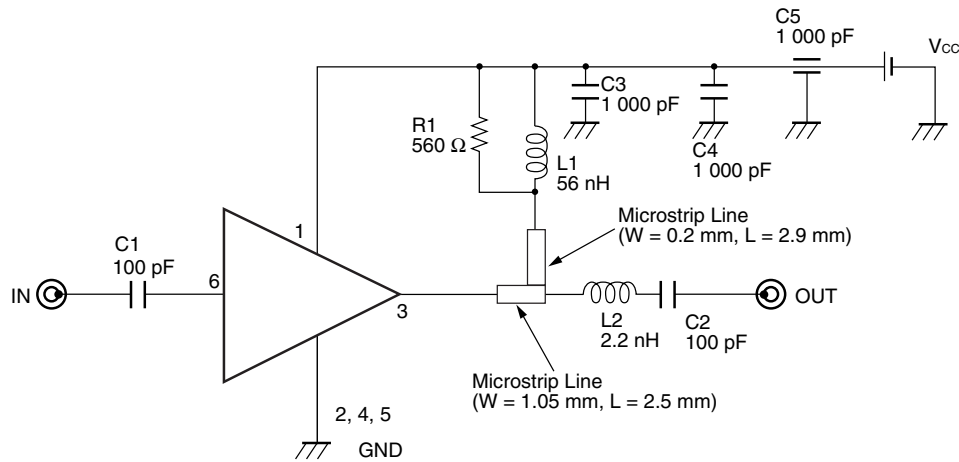

The application circuits and their parameters are for reference only and are not intended for use in actual design-ins.

COMPONENTS OF TEST CIRCUIT FOR MEASURING ELECTRICAL CHARACTERISTICS

	Type	Value
R1	Chip Resistance	560 Ω
L1	Chip Inductor	56 nH
L2	Chip Inductor	2.2 nH
C1, C2	Chip Capacitor	100 pF
C3, C4	Chip Capacitor	1 000 pF
C5	Feed-through Capacitor	1 000 pF

INDUCTOR FOR THE OUTPUT PIN

The internal output transistor of this IC, to output medium power. To supply current for output transistor, connect an inductor between the Vcc pin (pin 1) and output pin (pin 3). Select inductance, as the value listed above.

The inductor has both DC and AC effects. In terms of DC, the inductor biases the output transistor with minimum voltage drop to output enable high level. In terms of AC, the inductor makes output-port impedance higher to get enough gain. In this case, large inductance and Q is suitable (Refer to the following page).

CAPACITORS FOR THE Vcc, INPUT AND OUTPUT PINS

Capacitors of 1 000 pF are recommendable as the bypass capacitor for the Vcc pin and the coupling capacitors for the input and output pins.

The bypass capacitor connected to the Vcc pin is used to minimize ground impedance of Vcc pin. So, stable bias can be supplied against Vcc fluctuation.

The coupling capacitors, connected to the input and output pins, are used to cut the DC and minimize RF serial impedance. Their capacitances are therefore selected as lower impedance against a 50 Ω load. The capacitors thus perform as high pass filters, suppressing low frequencies to DC.

To obtain a flat gain from 100 MHz upwards, 1 000 pF capacitors are used in the test circuit. In the case of under 10 MHz operation, increase the value of coupling capacitor such as 10 000 pF. Because the coupling capacitors are determined by equation, $C = 1/(2 \pi Rfc)$.

ILLUSTRATION OF THE TEST CIRCUIT ASSEMBLED ON EVALUATION BOARD

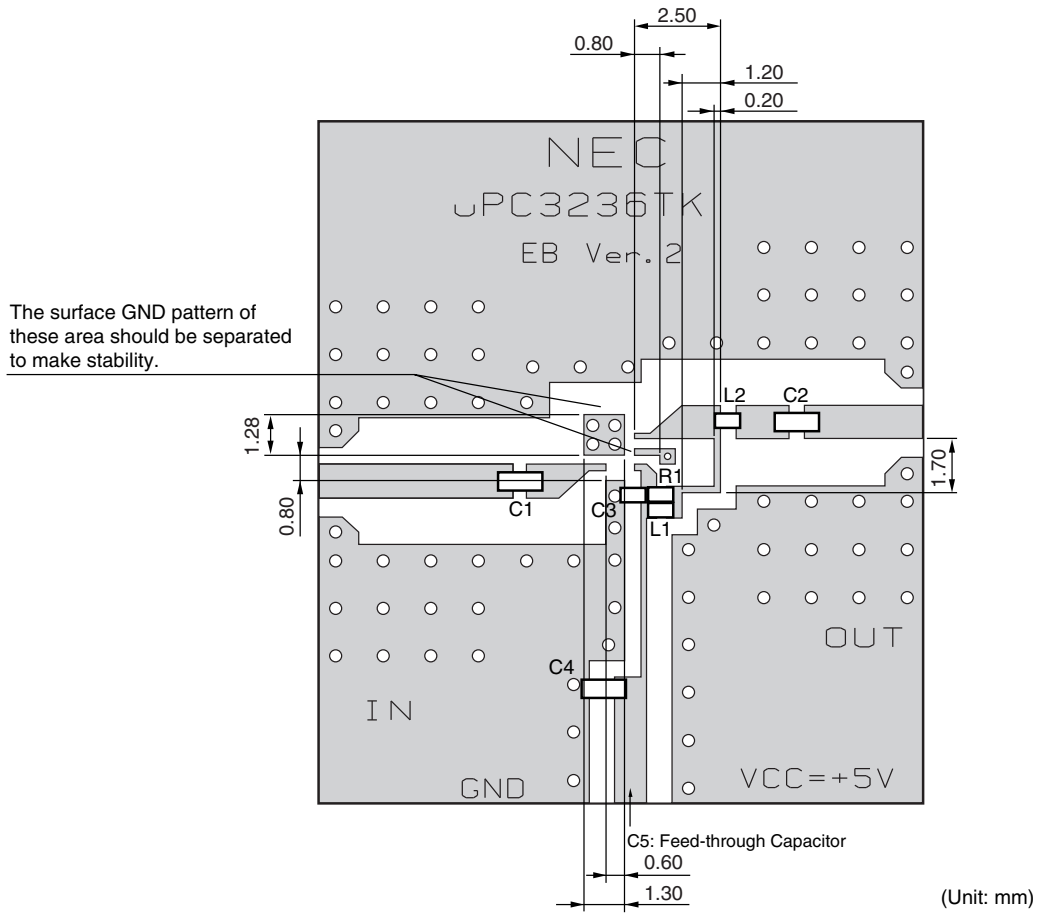

COMPONENT LIST

	Value	Size
R1	560 Ω	1005
L1	56 nH	1005
L2	2.2 nH	1005
C1, C2	100 pF	1608
C3	1 000 pF	1005
C4	1 000 pF	1608
C5	1 000 pF	Feed-through Capacitor

Notes

1. 19 × 21.46 × 0.51 mm double sided 18 μm copper clad RO4003C (Rogers) board.
2. Back side: GND pattern
3. Au plated on pattern
4. ○○ : Through holes (φ 0.40, φ 0.30)
5. L1, L2: FDK's products

TYPICAL CHARACTERISTICS ($T_A = +25^\circ\text{C}$, $V_{CC} = V_{out} = 5.0\text{ V}$, $Z_s = Z_L = 50\ \Omega$, unless otherwise specified)

CIRCUIT CURRENT vs. SUPPLY VOLTAGE

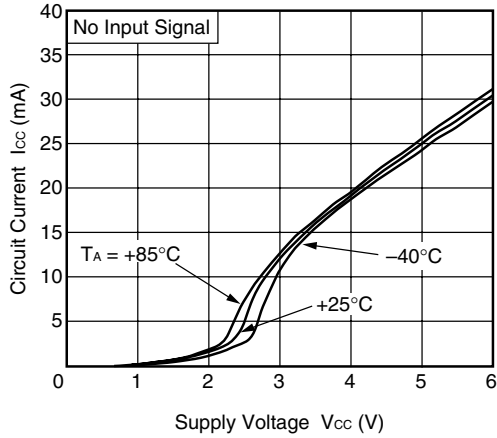

CIRCUIT CURRENT vs. OPERATING AMBIENT TEMPERATURE

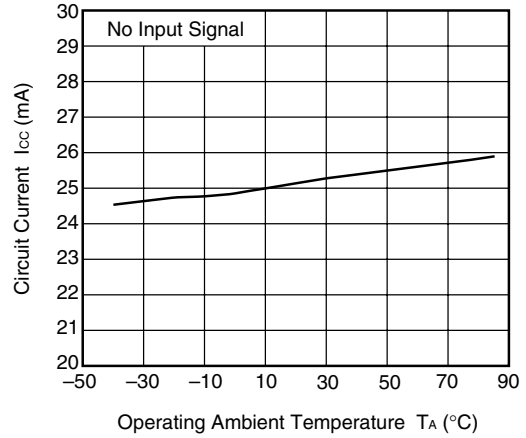

POWER GAIN vs. FREQUENCY

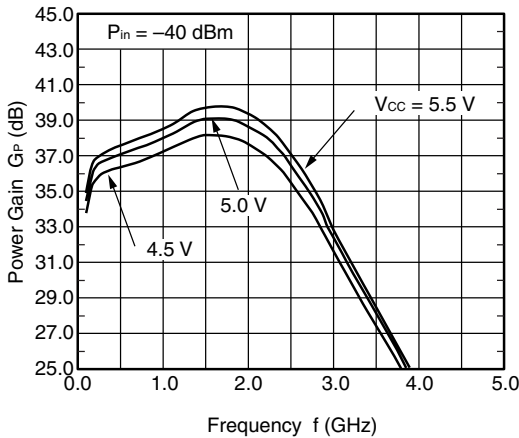

INPUT RETURN LOSS vs. FREQUENCY

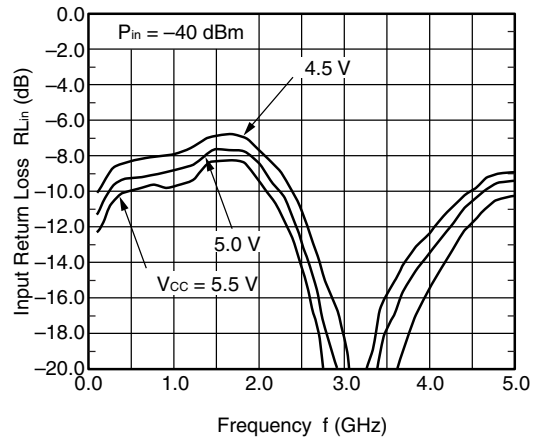

ISOLATION vs. FREQUENCY

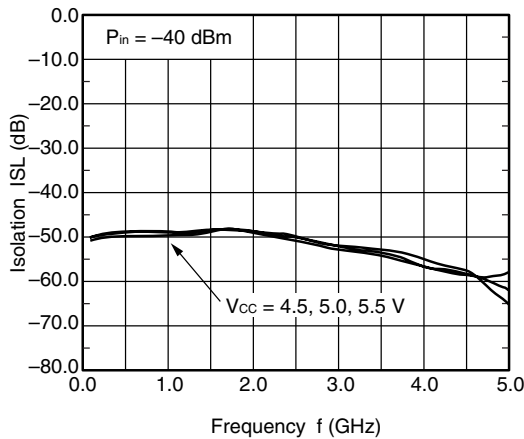

OUTPUT RETURN LOSS vs. FREQUENCY

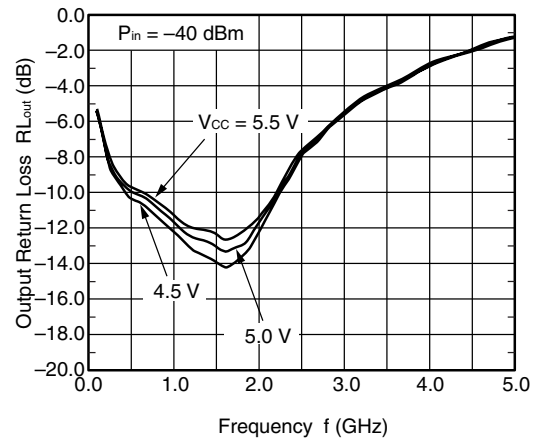

Remark The graphs indicate nominal characteristics.

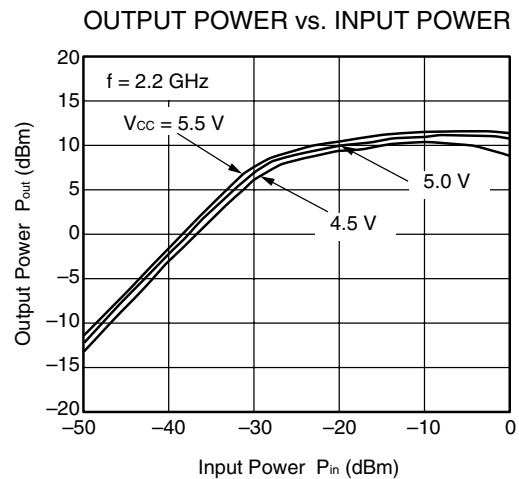
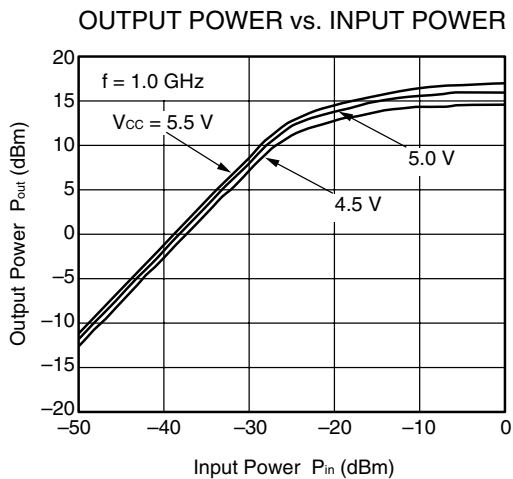
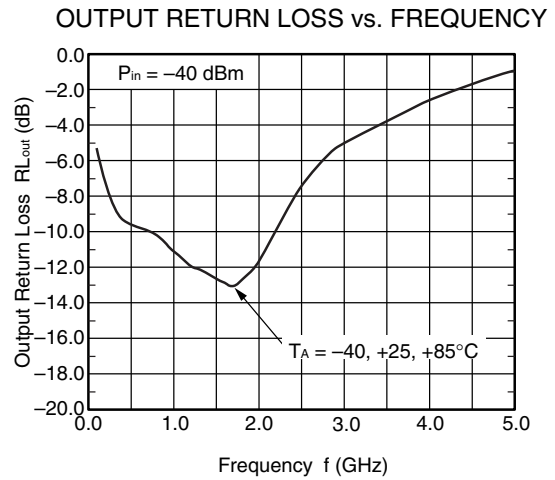
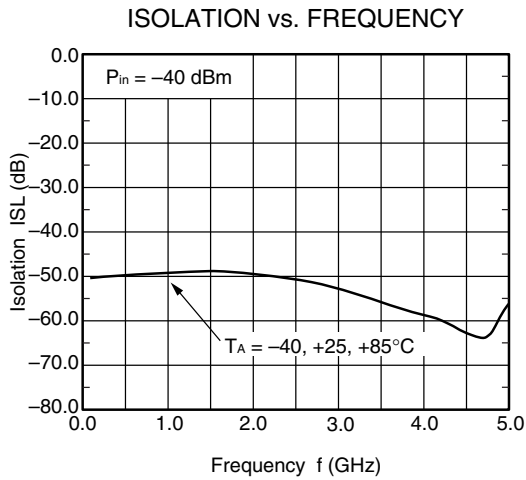
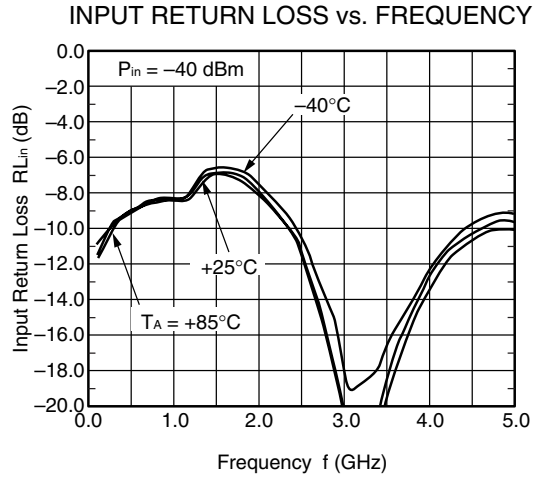
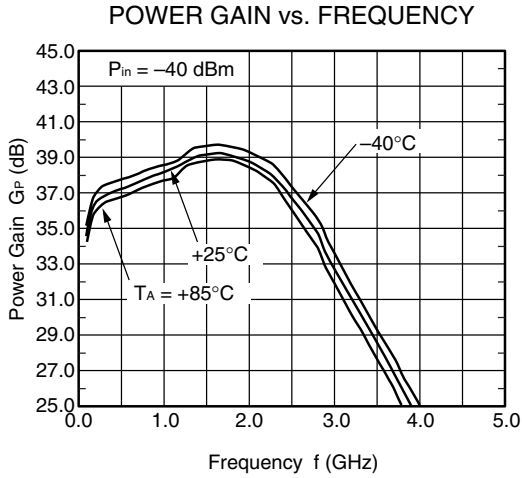

Remark The graphs indicate nominal characteristics.

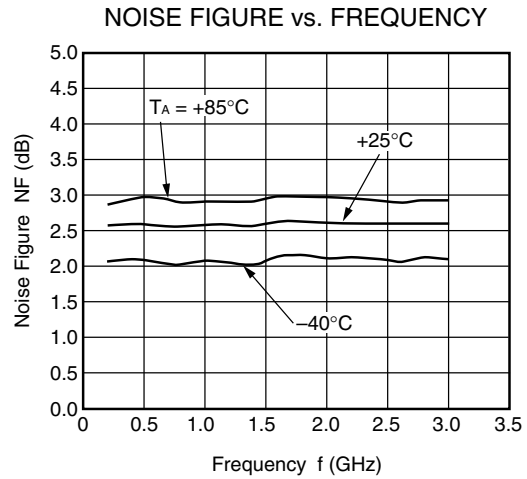
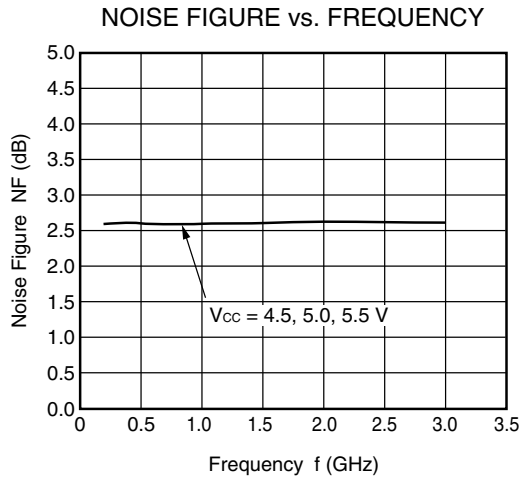
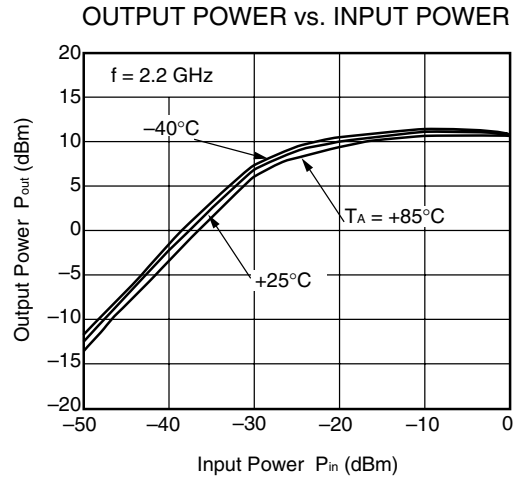
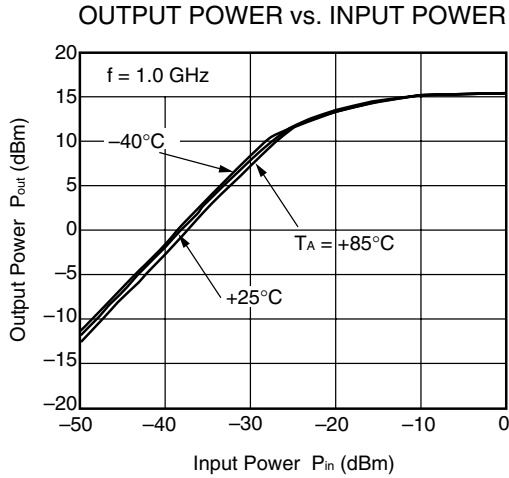

Remark The graphs indicate nominal characteristics.

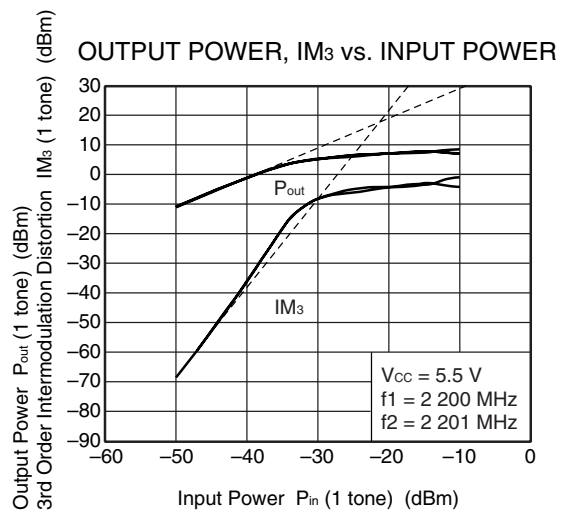
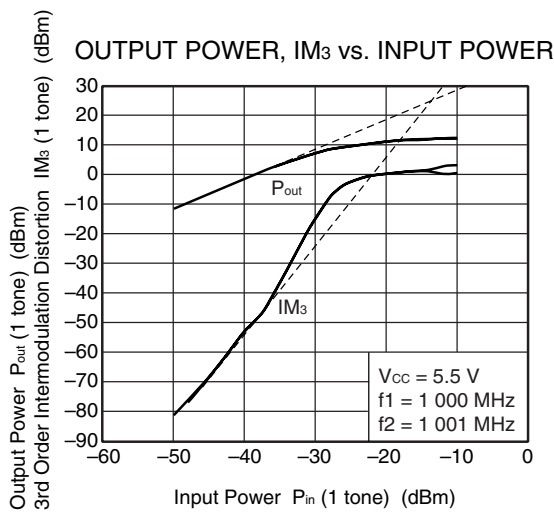
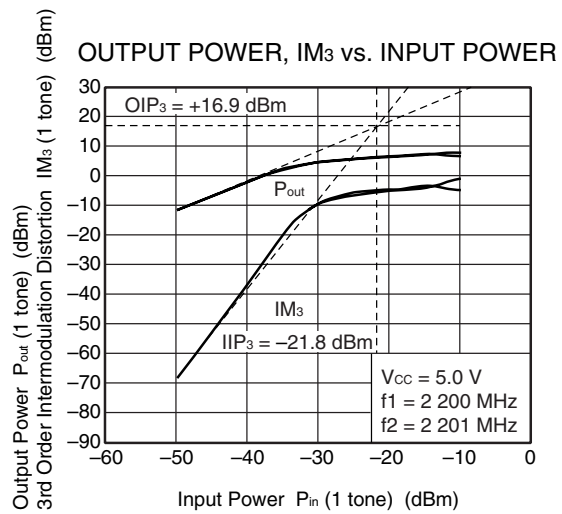
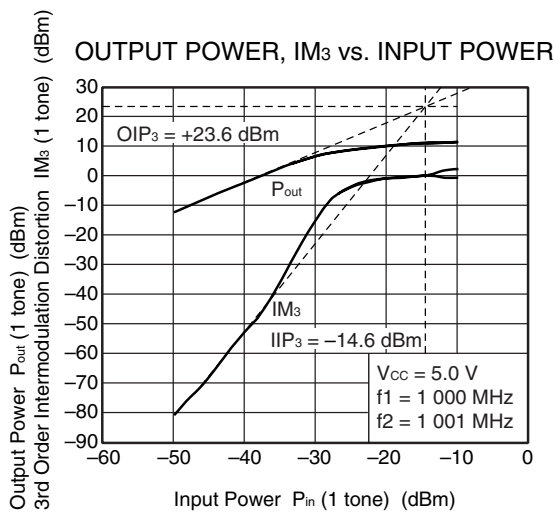
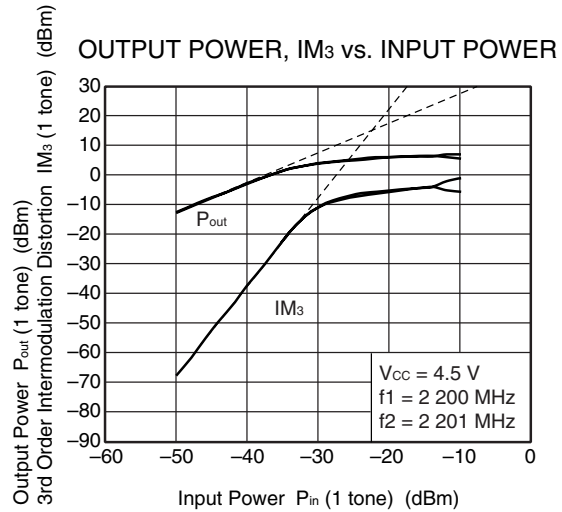
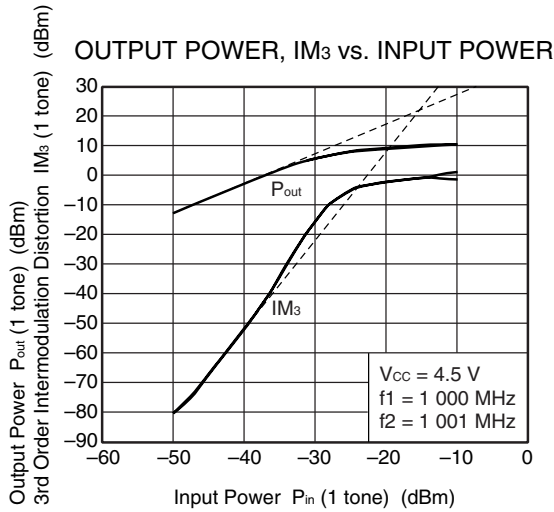

Remark The graphs indicate nominal characteristics.

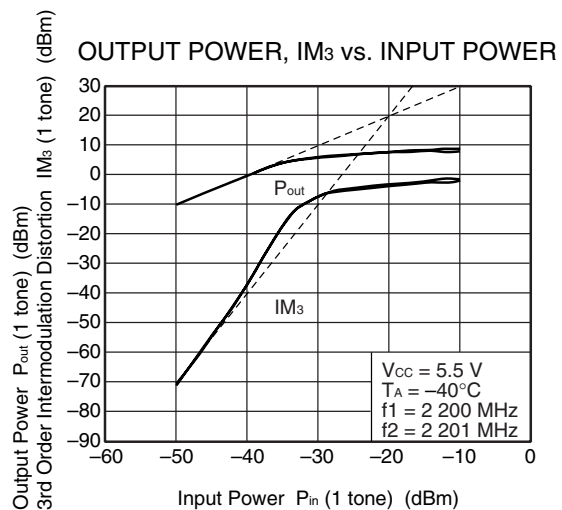
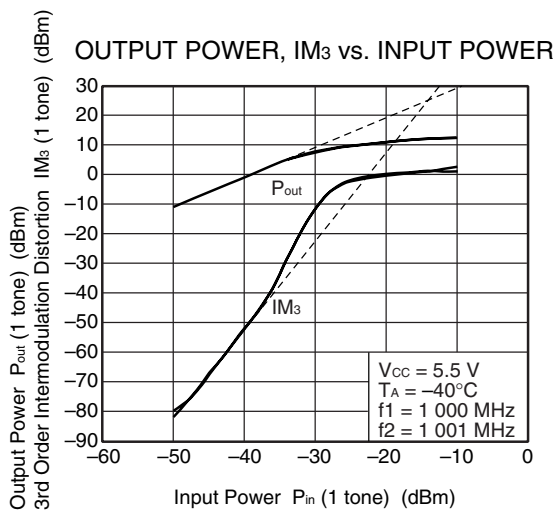
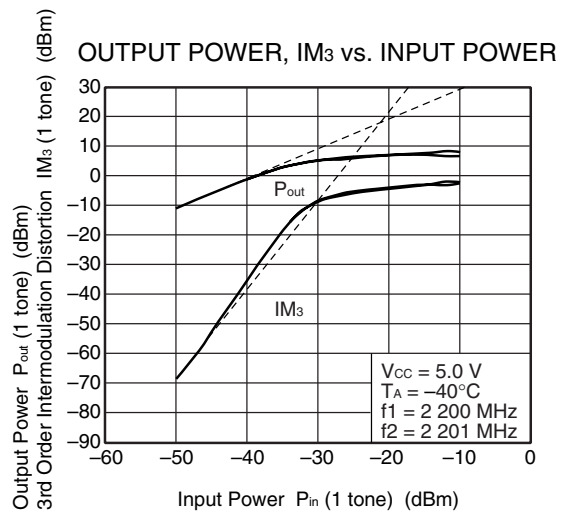
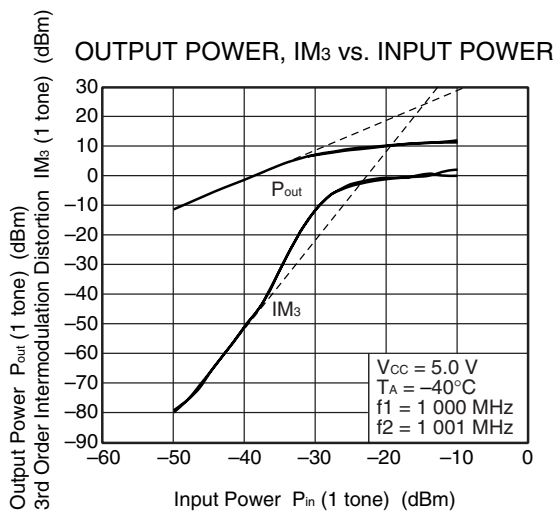
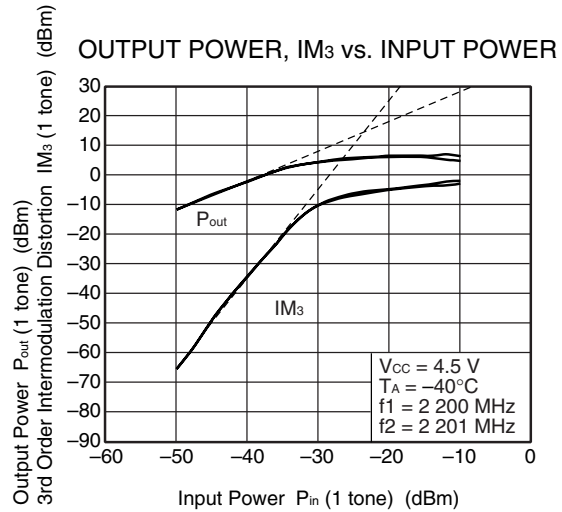
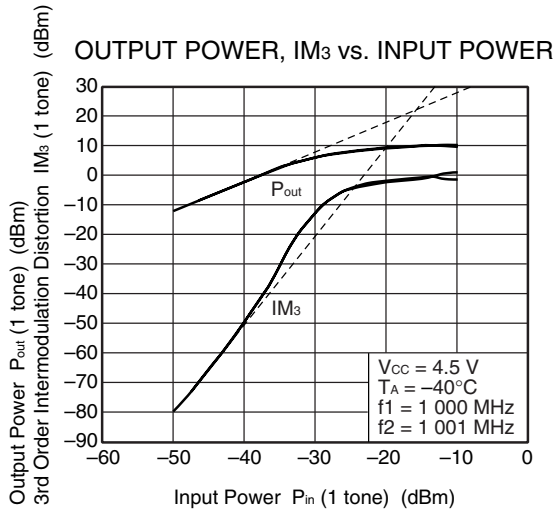

Remark The graphs indicate nominal characteristics.

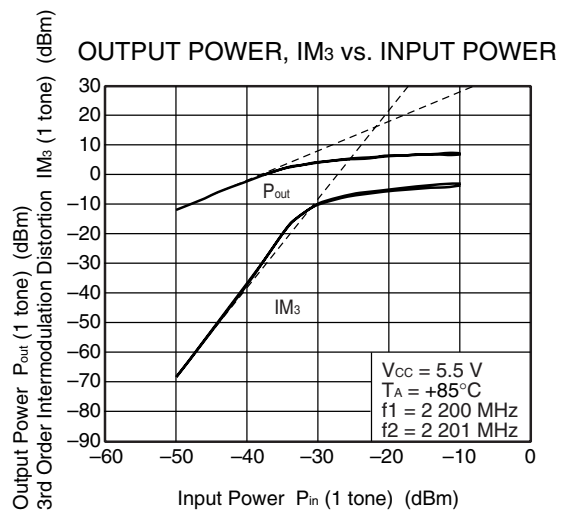
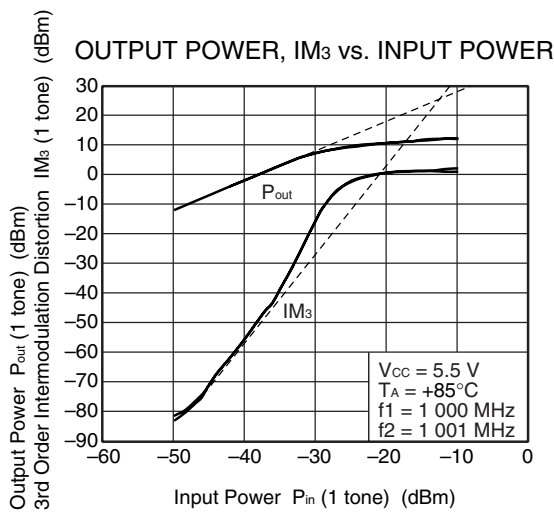
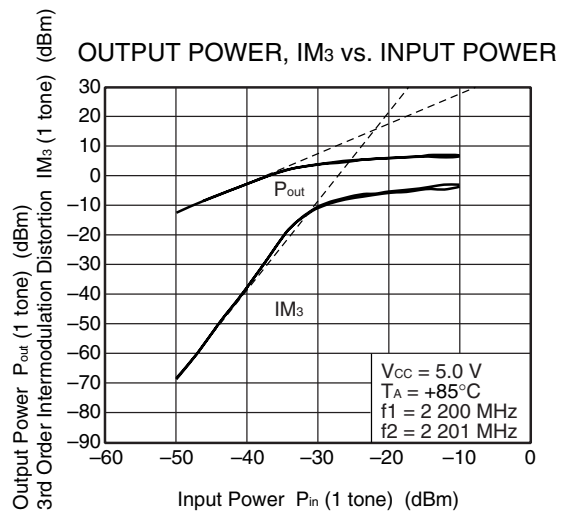
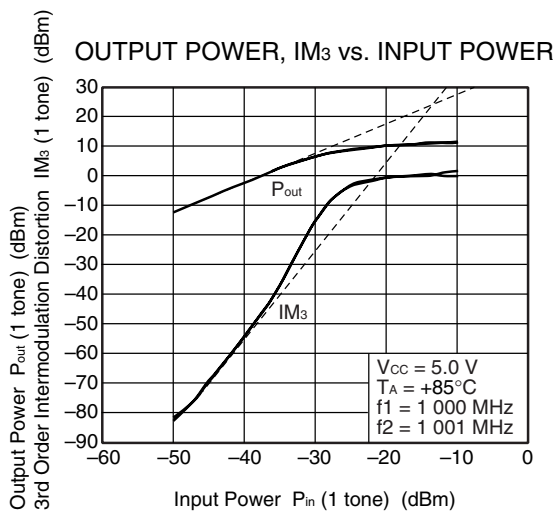
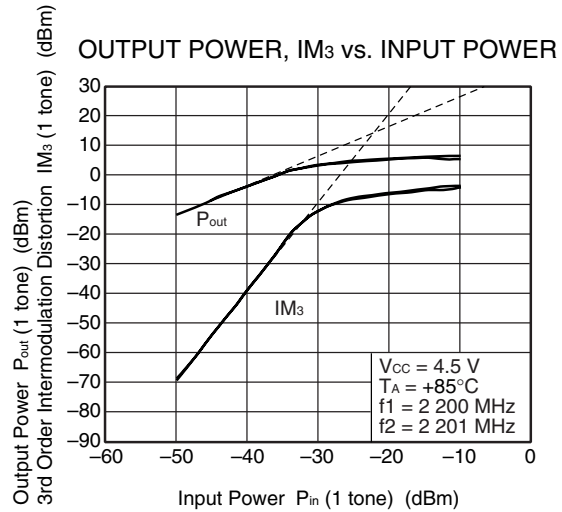
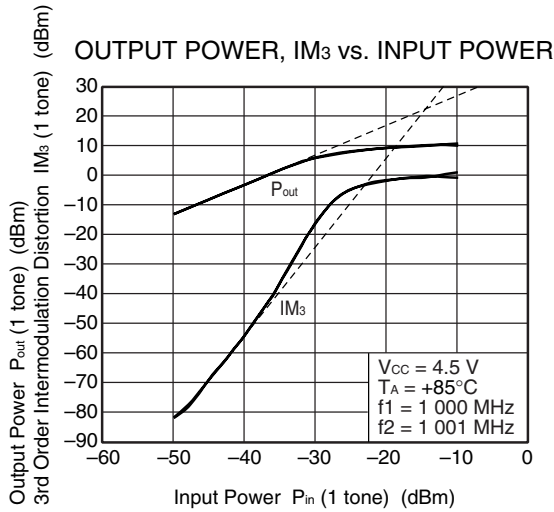

Remark The graphs indicate nominal characteristics.

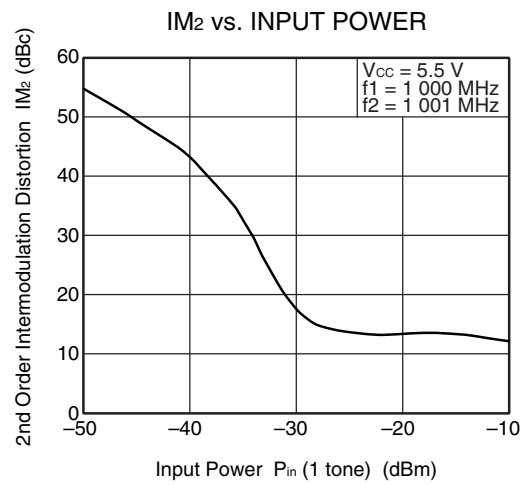
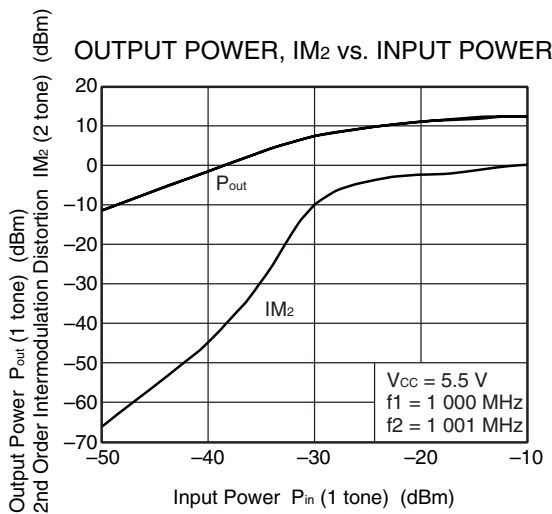
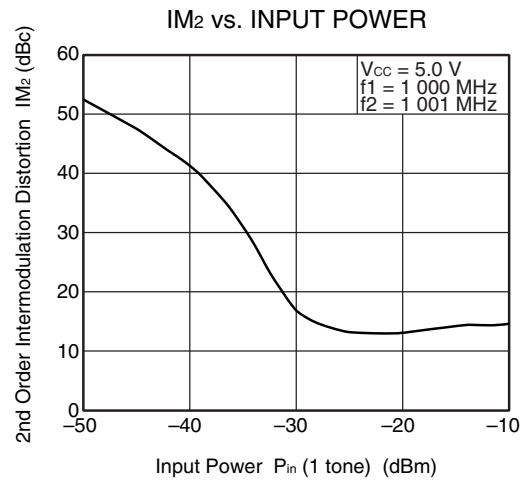
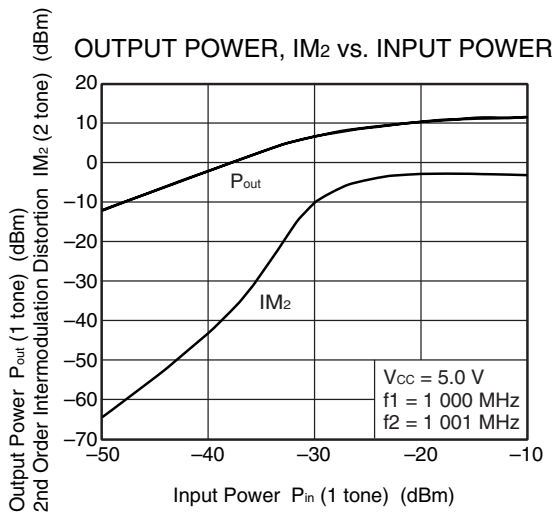
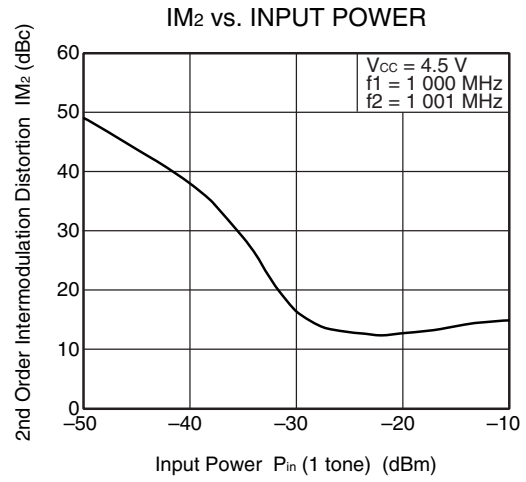
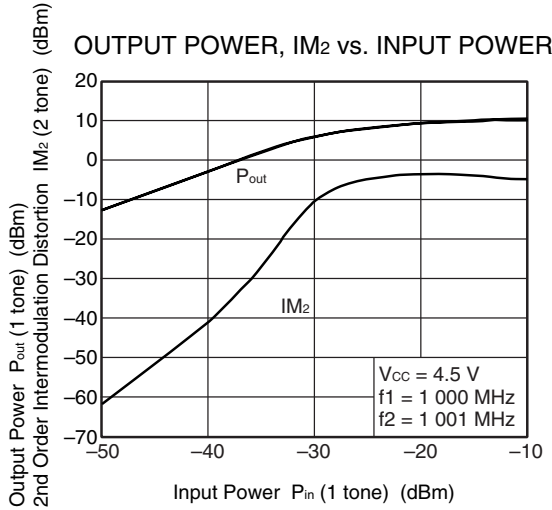

Remark The graphs indicate nominal characteristics.

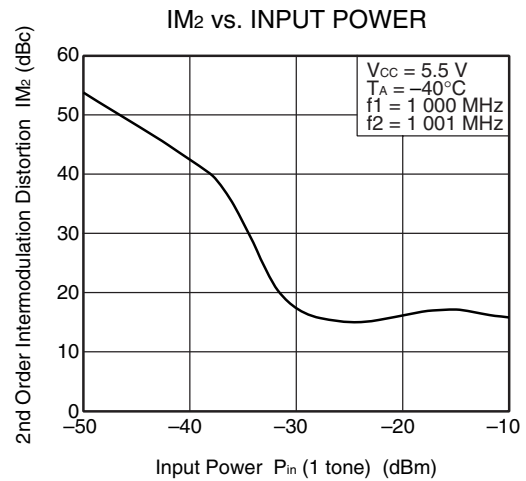
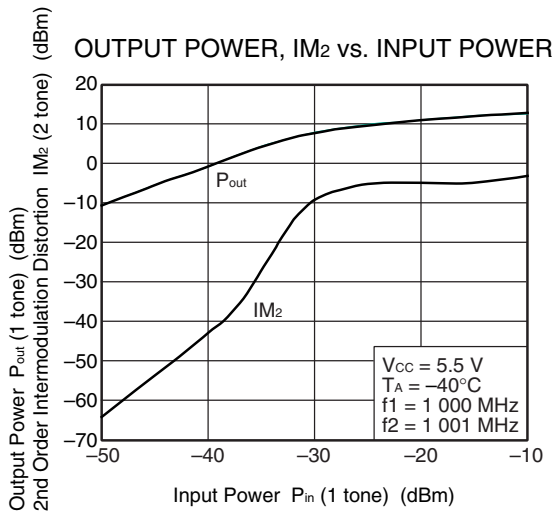
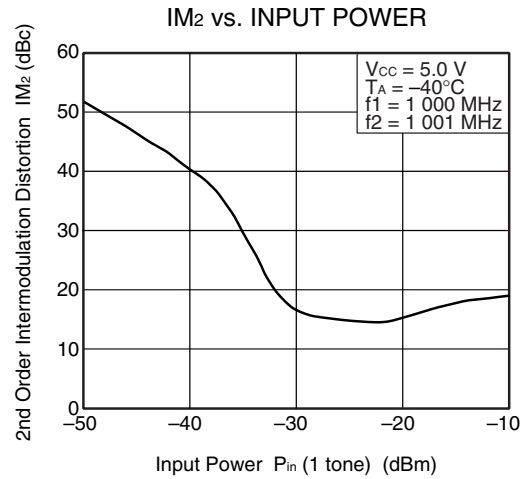
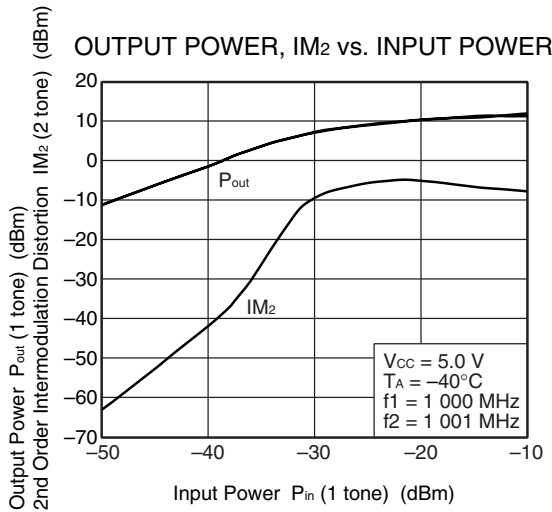
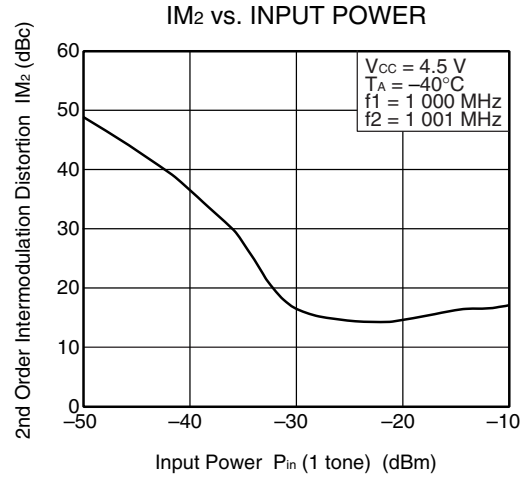
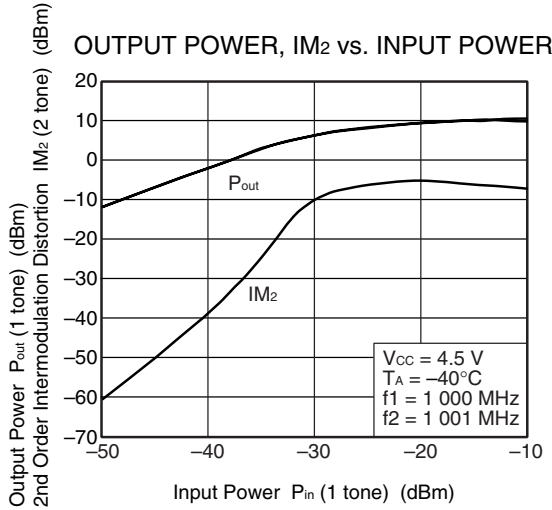

Remark The graphs indicate nominal characteristics.

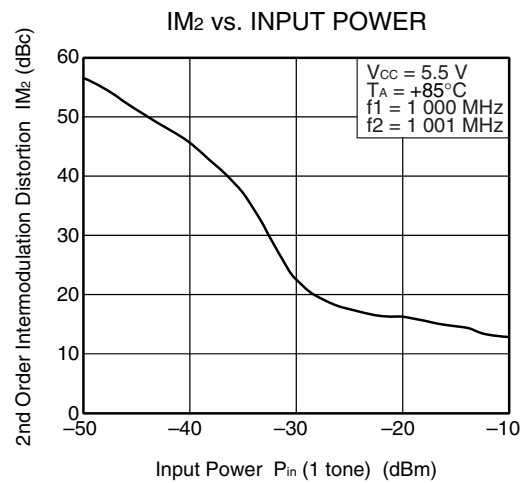
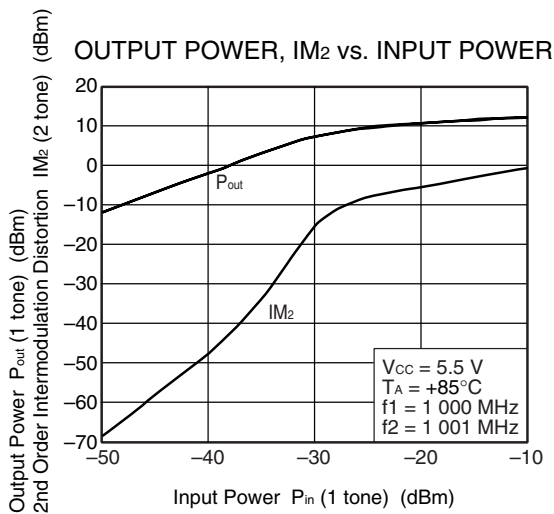
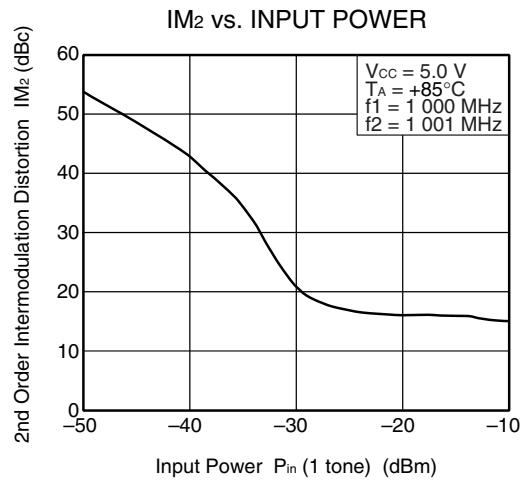
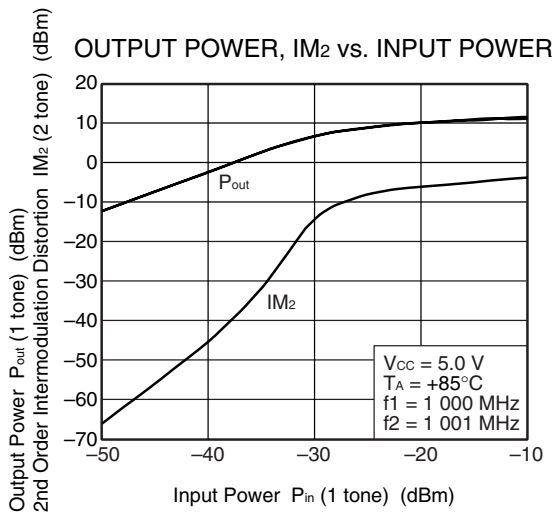
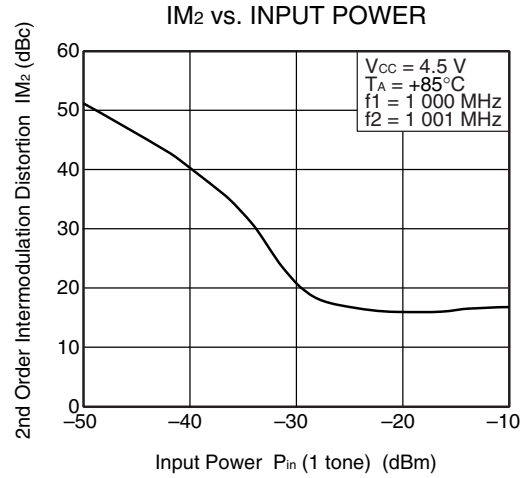
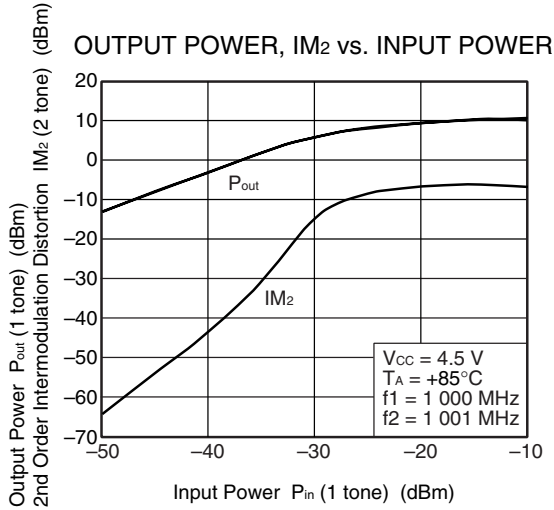

Remark The graphs indicate nominal characteristics.

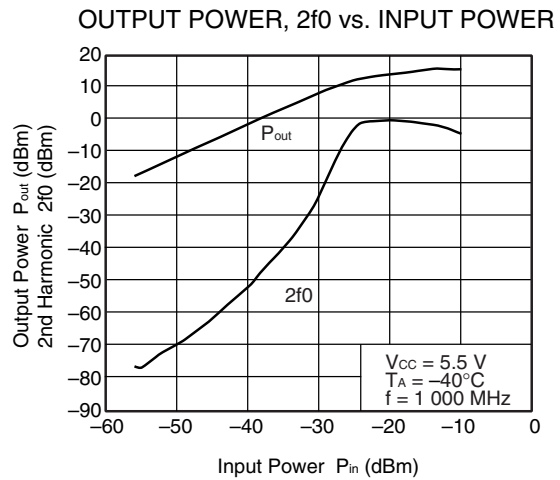
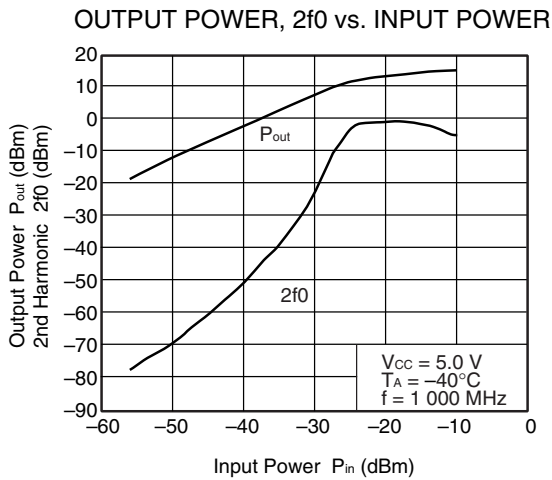
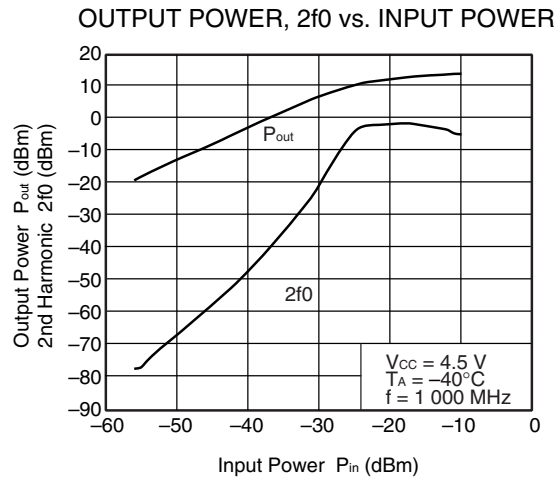
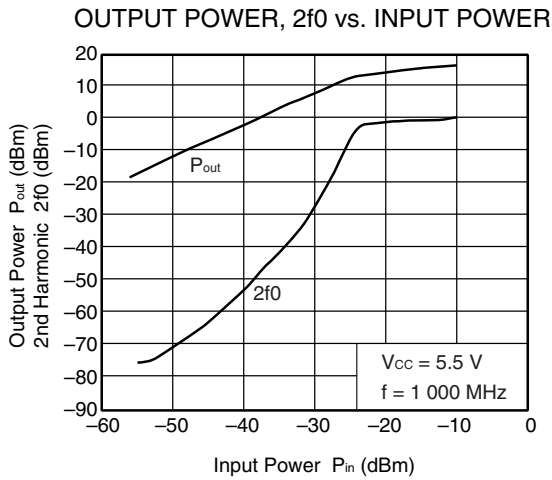
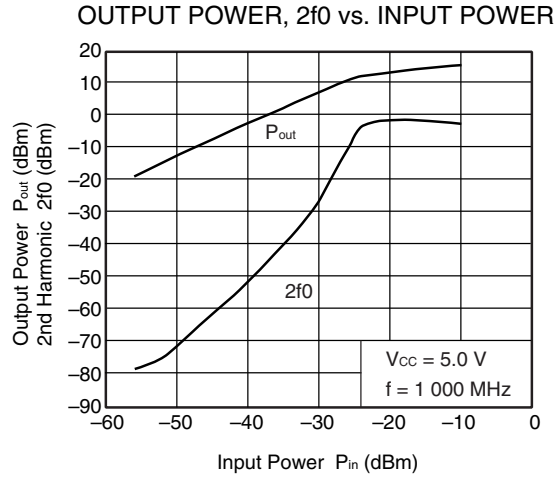
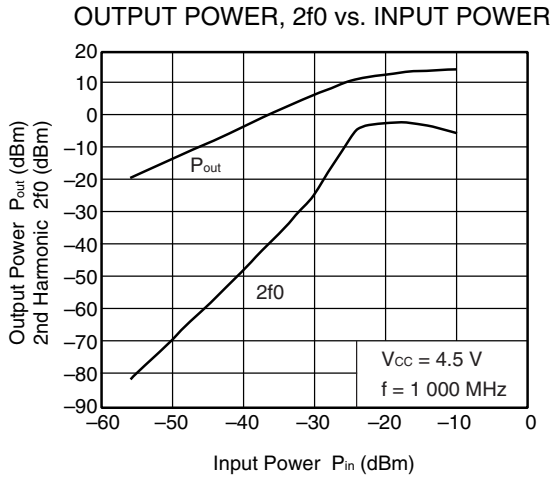

Remark The graphs indicate nominal characteristics.

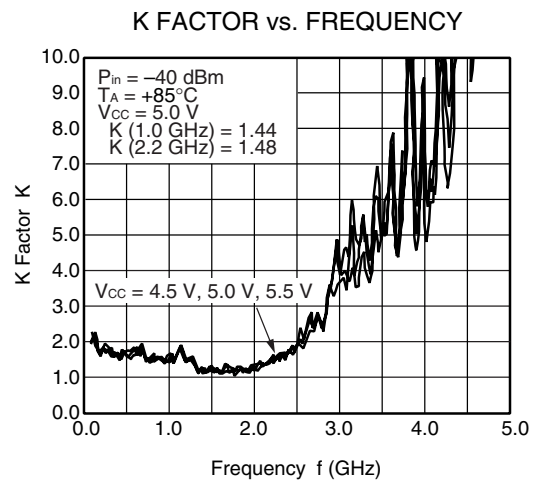
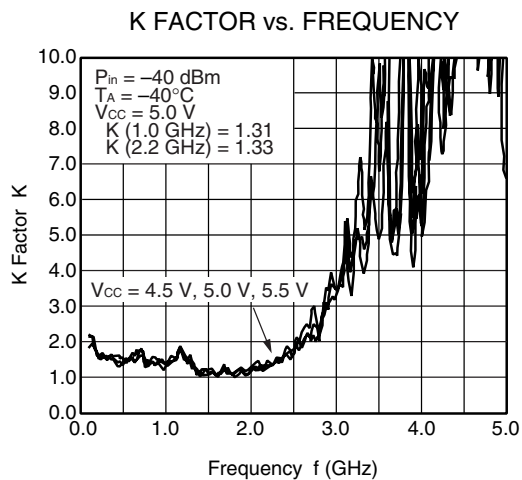
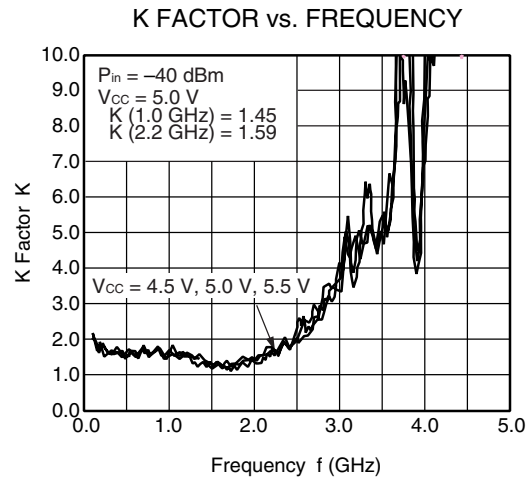
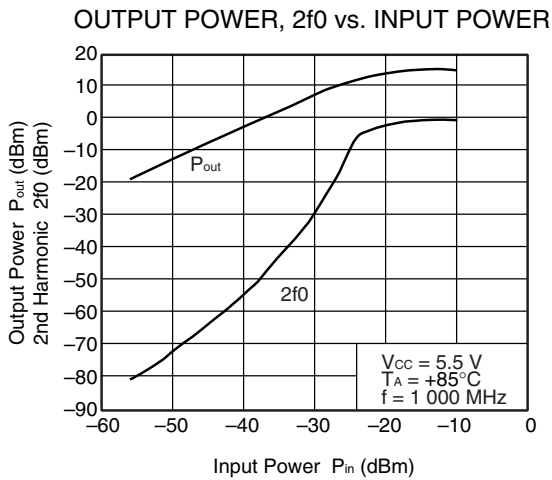
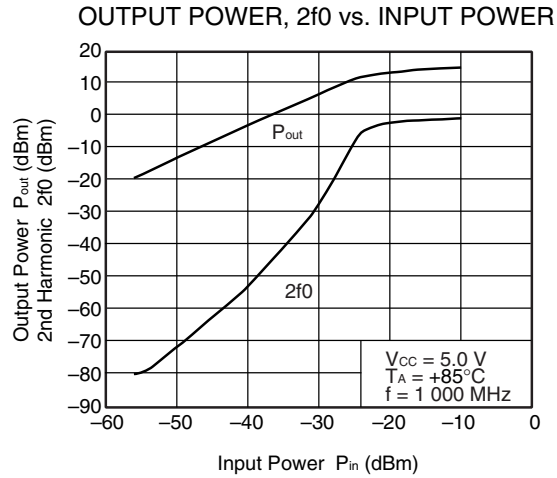
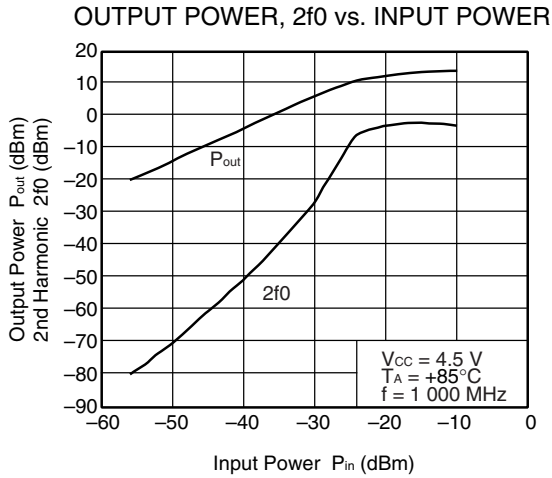

Remark The graphs indicate nominal characteristics.

S-PARAMETERS ($T_A = +25^\circ\text{C}$, $V_{CC} = V_{out} = 5.0\text{ V}$, $P_{in} = -40\text{ dBm}$)

S₁₁-FREQUENCY

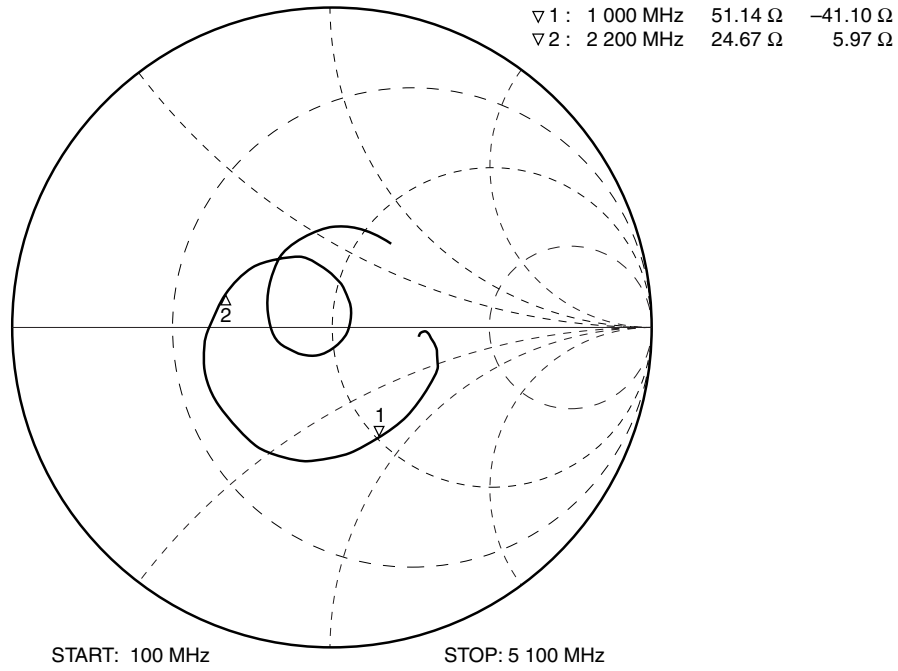

S₂₂-FREQUENCY

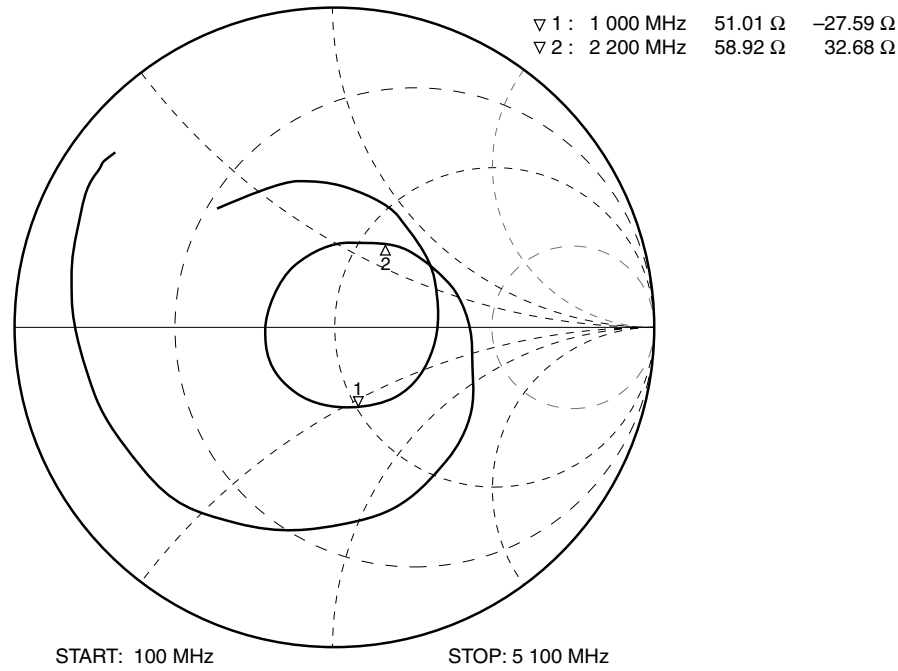

- Remarks 1.** Measured on the test circuit of evaluation board.
2. The graphs indicate nominal characteristics.

S-PARAMETERS

S-parameters and noise parameters are provided on our Web site in a format (S2P) that enables the direct import of the parameters to microwave circuit simulators without the need for keyboard inputs.

Click here to download S-parameters.

[RF and Microwave] → [Device Parameters]

URL <http://www.necel.com/microwave/en/>

PACKAGE DIMENSIONS

6-PIN LEAD-LESS MINIMOLD (1511 PKG) (UNIT: mm)

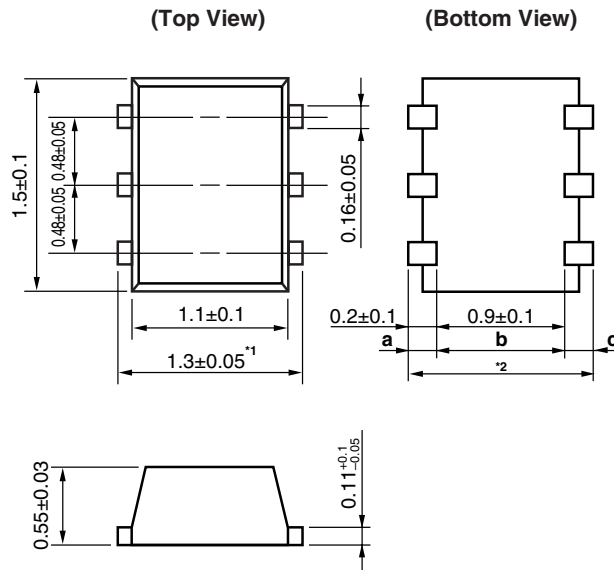

Remark Dimension ¹ is bigger than dimension ² (dimension ² = a + b + c).

NOTES ON CORRECT USE

- (1) Observe precautions for handling because of electro-static sensitive devices.
- (2) Form a ground pattern as widely as possible to minimize ground impedance (to prevent undesired oscillation).
There are the surface GND pattern area that must be separated to make stability.
- (3) The bypass capacitor should be attached to the V_{CC} line.
- (4) The inductor (L) must be attached between V_{CC} and output pins. The inductance value should be determined in accordance with desired frequency.
- (5) The DC cut capacitor must be attached to input and output pin.

RECOMMENDED SOLDERING CONDITIONS

This product should be soldered and mounted under the following recommended conditions. For soldering methods and conditions other than those recommended below, contact your nearby sales office.

Soldering Method	Soldering Conditions	Condition Symbol
Infrared Reflow	Peak temperature (package surface temperature) : 260°C or below Time at peak temperature : 10 seconds or less Time at temperature of 220°C or higher : 60 seconds or less Preheating time at 120 to 180°C : 120±30 seconds Maximum number of reflow processes : 3 times Maximum chlorine content of rosin flux (% mass) : 0.2%(Wt.) or below	IR260
Wave Soldering	Peak temperature (molten solder temperature) : 260°C or below Time at peak temperature : 10 seconds or less Preheating temperature (package surface temperature) : 120°C or below Maximum number of flow processes : 1 time Maximum chlorine content of rosin flux (% mass) : 0.2%(Wt.) or below	WS260
Partial Heating	Peak temperature (terminal temperature) : 350°C or below Soldering time (per side of device) : 3 seconds or less Maximum chlorine content of rosin flux (% mass) : 0.2%(Wt.) or below	HS350

Caution Do not use different soldering methods together (except for partial heating).

- **The information in this document is current as of December, 2008. The information is subject to change without notice. For actual design-in, refer to the latest publications of NEC Electronics data sheets or data books, etc., for the most up-to-date specifications of NEC Electronics products. Not all products and/or types are available in every country. Please check with an NEC Electronics sales representative for availability and additional information.**
- No part of this document may be copied or reproduced in any form or by any means without the prior written consent of NEC Electronics. NEC Electronics assumes no responsibility for any errors that may appear in this document.
- NEC Electronics does not assume any liability for infringement of patents, copyrights or other intellectual property rights of third parties by or arising from the use of NEC Electronics products listed in this document or any other liability arising from the use of such products. No license, express, implied or otherwise, is granted under any patents, copyrights or other intellectual property rights of NEC Electronics or others.
- Descriptions of circuits, software and other related information in this document are provided for illustrative purposes in semiconductor product operation and application examples. The incorporation of these circuits, software and information in the design of a customer's equipment shall be done under the full responsibility of the customer. NEC Electronics assumes no responsibility for any losses incurred by customers or third parties arising from the use of these circuits, software and information.
- While NEC Electronics endeavors to enhance the quality, reliability and safety of NEC Electronics products, customers agree and acknowledge that the possibility of defects thereof cannot be eliminated entirely. To minimize risks of damage to property or injury (including death) to persons arising from defects in NEC Electronics products, customers must incorporate sufficient safety measures in their design, such as redundancy, fire-containment and anti-failure features.
- NEC Electronics products are classified into the following three quality grades: "Standard", "Special" and "Specific".

The "Specific" quality grade applies only to NEC Electronics products developed based on a customer-designated "quality assurance program" for a specific application. The recommended applications of an NEC Electronics product depend on its quality grade, as indicated below. Customers must check the quality grade of each NEC Electronics product before using it in a particular application.

"Standard": Computers, office equipment, communications equipment, test and measurement equipment, audio and visual equipment, home electronic appliances, machine tools, personal electronic equipment and industrial robots.

"Special": Transportation equipment (automobiles, trains, ships, etc.), traffic control systems, anti-disaster systems, anti-crime systems, safety equipment and medical equipment (not specifically designed for life support).

"Specific": Aircraft, aerospace equipment, submersible repeaters, nuclear reactor control systems, life support systems and medical equipment for life support, etc.

The quality grade of NEC Electronics products is "Standard" unless otherwise expressly specified in NEC Electronics data sheets or data books, etc. If customers wish to use NEC Electronics products in applications not intended by NEC Electronics, they must contact an NEC Electronics sales representative in advance to determine NEC Electronics' willingness to support a given application.

(Note)

- (1) "NEC Electronics" as used in this statement means NEC Electronics Corporation and also includes its majority-owned subsidiaries.
- (2) "NEC Electronics products" means any product developed or manufactured by or for NEC Electronics (as defined above).